



US00D970035S

(12) **United States Design Patent** (10) **Patent No.:** **US D970,035 S**
He (45) **Date of Patent:** **** Nov. 15, 2022**

(54) **TOOTHBRUSH STERILIZER**

(71) Applicant: **Shenzhen beibei youpin technology co., LTD**, Shenzhen (CN)

(72) Inventor: **Jing He**, Ningxiang (CN)

(**) Term: **15 Years**

(21) Appl. No.: **29/796,401**

(22) Filed: **Jun. 24, 2021**

(51) **LOC (13) Cl.** **24-01**

(52) **U.S. Cl.**
USPC **D24/217**

(58) **Field of Classification Search**
USPC D24/216, 217, 218, 219, 231, 232, 234,
D24/209, 210; D32/1; D6/534; D28/44,
D28/73

CPC A61L 2/26; A61L 2/24; A61L 2/07; A61L
2/08; A61L 2/18; A61L 2/25; A61L
2202/122; A61L 2202/11; A61L 2202/14;
A61L 2202/23; A61L 2202/24; A61L
2202/25

See application file for complete search history.

(56) **References Cited**

U.S. PATENT DOCUMENTS

D502,546 S *	3/2005	Shin	D6/534
D556,337 S *	11/2007	Davis	D24/217
D635,385 S *	4/2011	Renault	D6/534
D888,268 S *	6/2020	Oh	D24/217
D920,533 S *	5/2021	Park	D24/217
D924,428 S *	7/2021	Chen	D24/217
D940,347 S *	1/2022	Park	D24/217
D948,071 S *	4/2022	Park	D24/217
2021/0345767 A1 *	11/2021	Zheng	A61L 2/10

OTHER PUBLICATIONS

Amazon.com: UV Toothbrush sanitizer sterilizer Holder case Wall Mount , Toothbrush Holder sanitizer with Toothpaste Dispenser Toothbrush. Product first available: Jan. 26, 2021. Retrieved from internet on Jul. 2, 2022 at: https://www.amazon.com/SHUKAN-Toothbrush-Sanitizer-Bathroom-Organizer/dp/B08V1JGJ9V/ref=psdc_3731971_t2_B08MTDTW36?th=1.*

* cited by examiner

Primary Examiner — Anhdao Doan

(74) *Attorney, Agent, or Firm* — Rumit Ranjit Kanakia

(57) **CLAIM**

I claim the ornamental design for a toothbrush sterilizer, as shown and described.

DESCRIPTION

FIG. 1 is a Perspective view of a toothbrush sterilizer showing my new design;
FIG. 2 is a Back Perspective view thereof;
FIG. 3 is a Front view thereof;
FIG. 4 is a Back view thereof;
FIG. 5 is a Left-side view thereof;
FIG. 6 is a Right-side view thereof;
FIG. 7 is a Top view thereof;
FIG. 8 is a Bottom view thereof; and,
FIG. 9 is a Perspective view of a toothbrush sterilizer showing in use view.

The broken lines depicting the toothbrushes in FIG. 9 represent environmental subject matter and form no part of the claimed design; and the other broken lines illustrate portions of the toothbrush sterilizer that form no part of the claimed design.

1 Claim, 9 Drawing Sheets

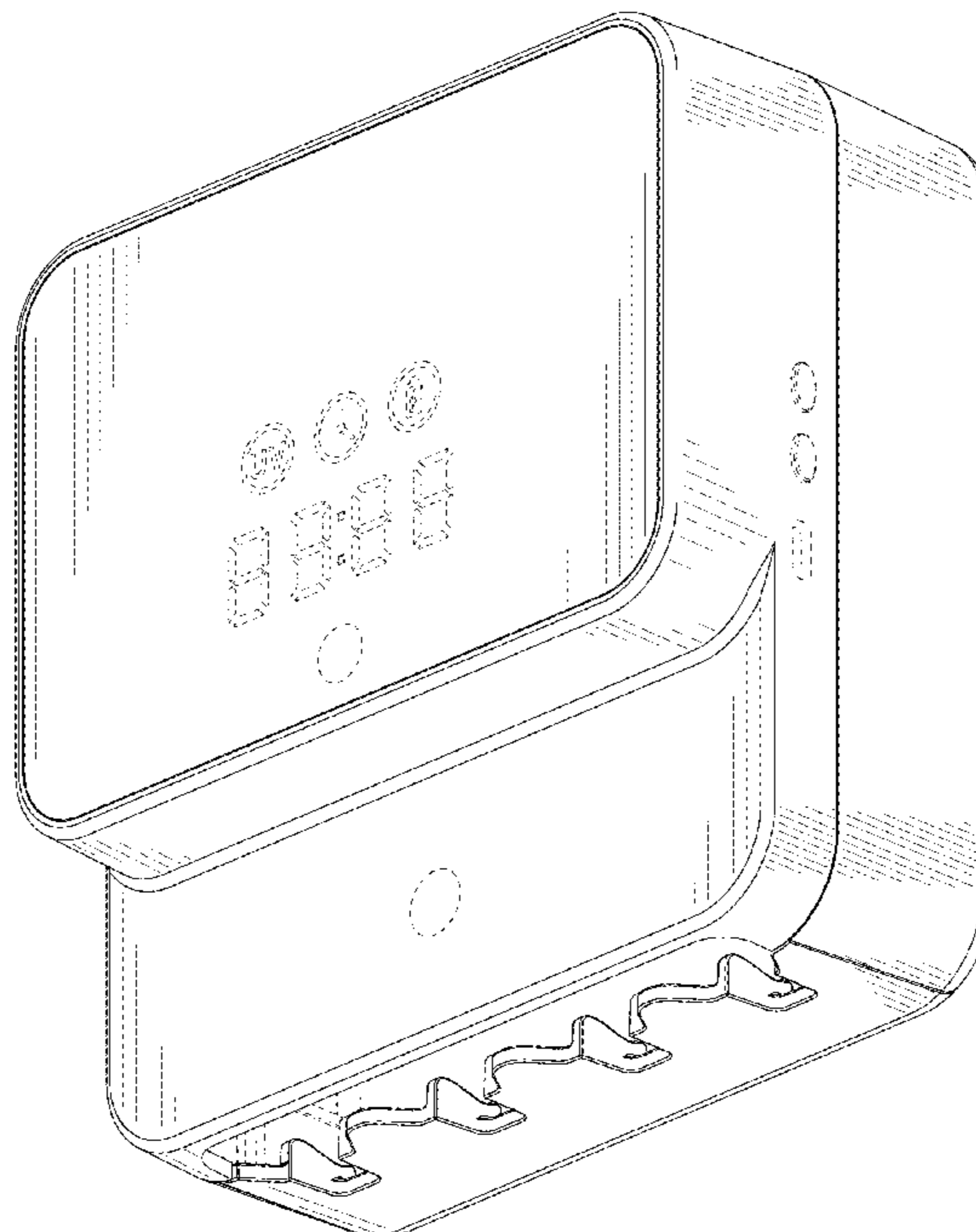

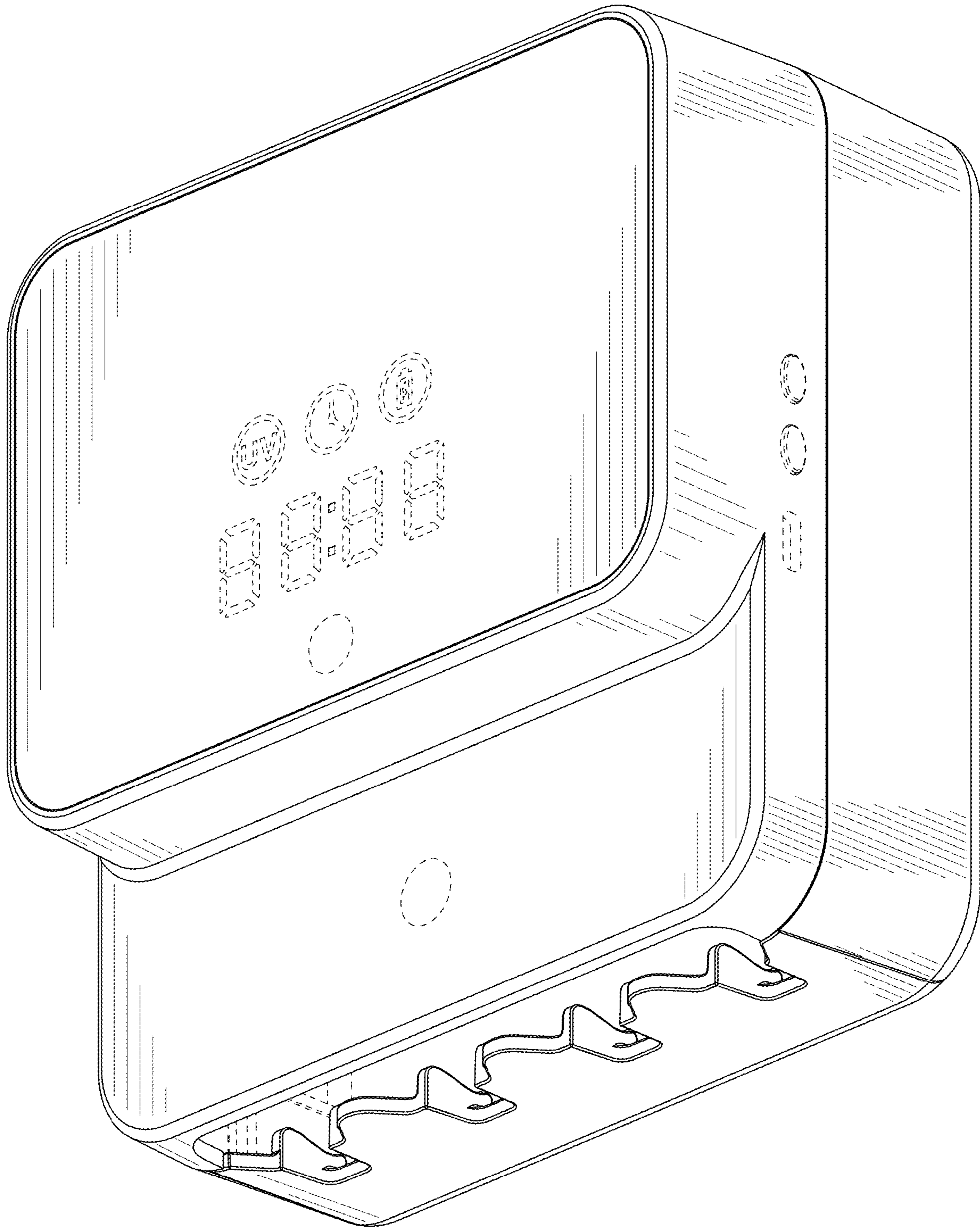

FIG. 1

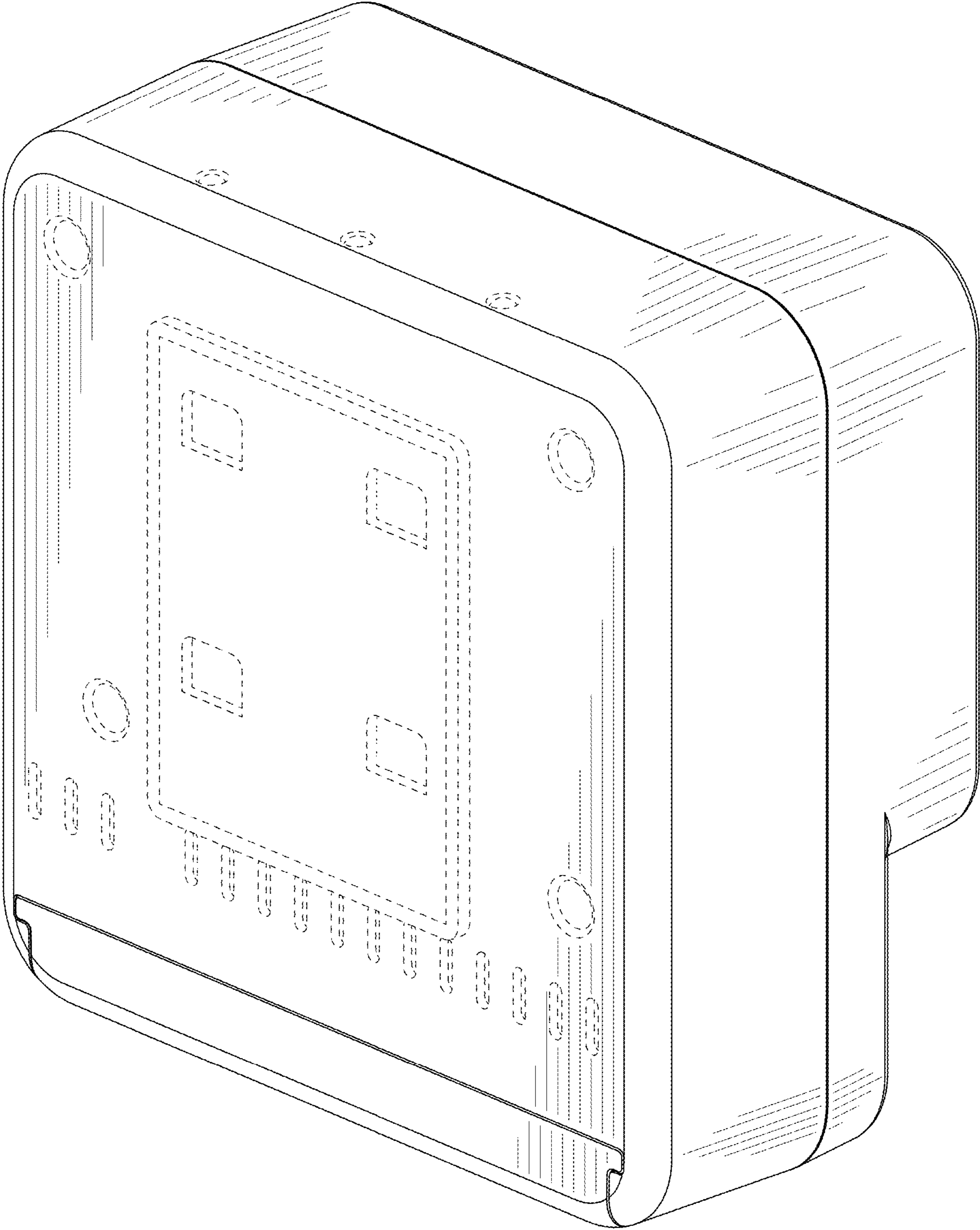

FIG. 2

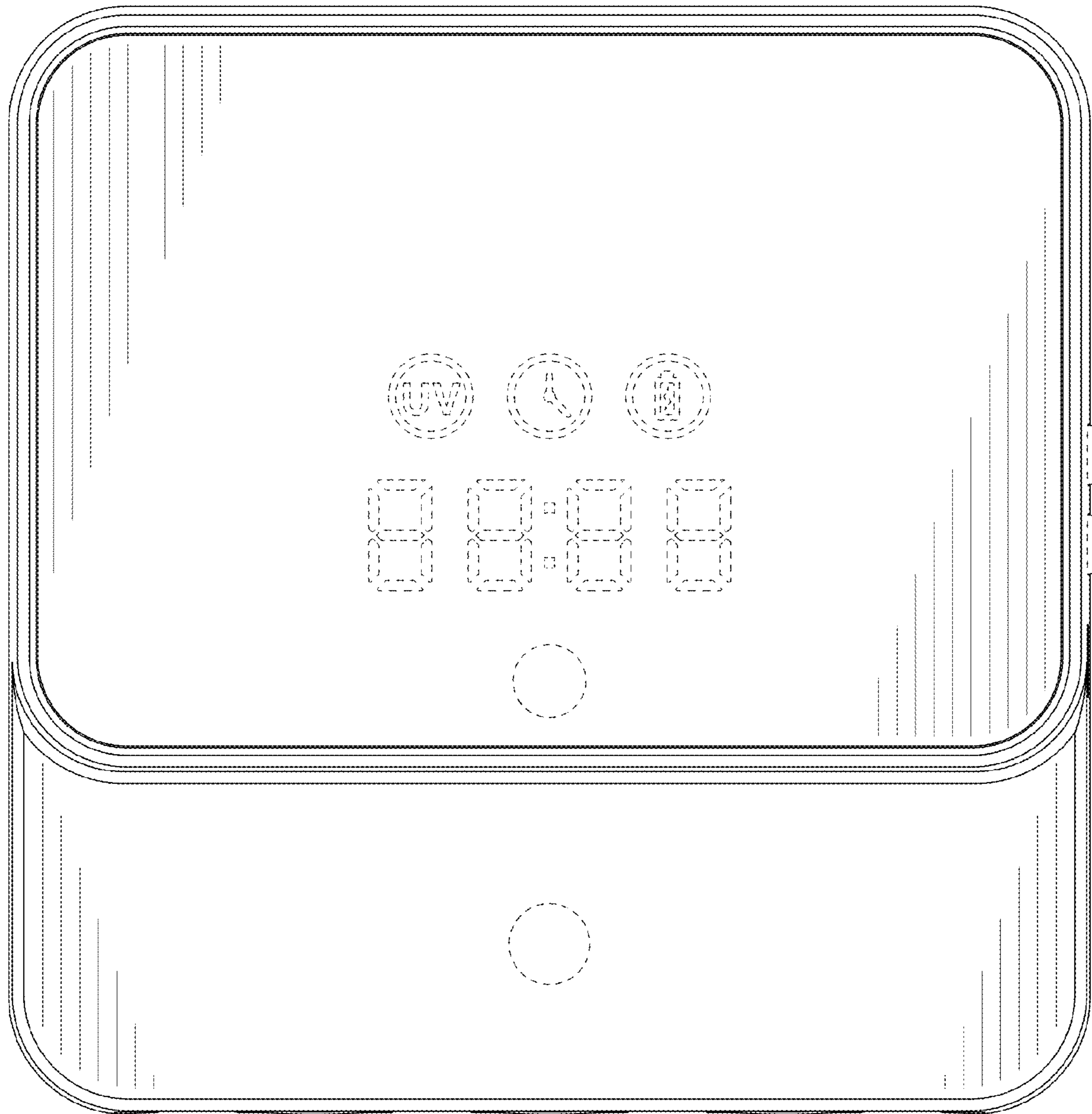

FIG. 3

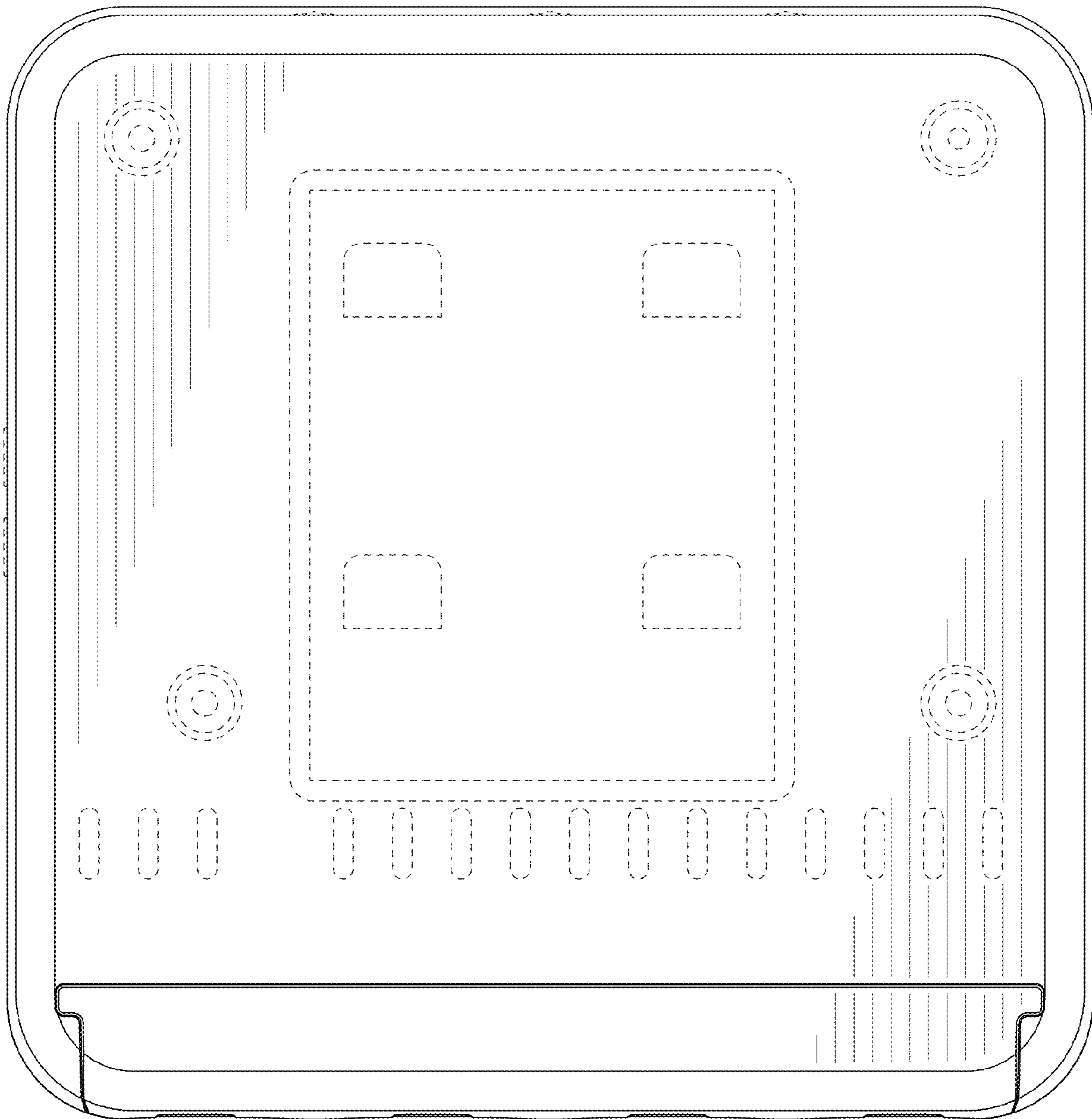

FIG. 4

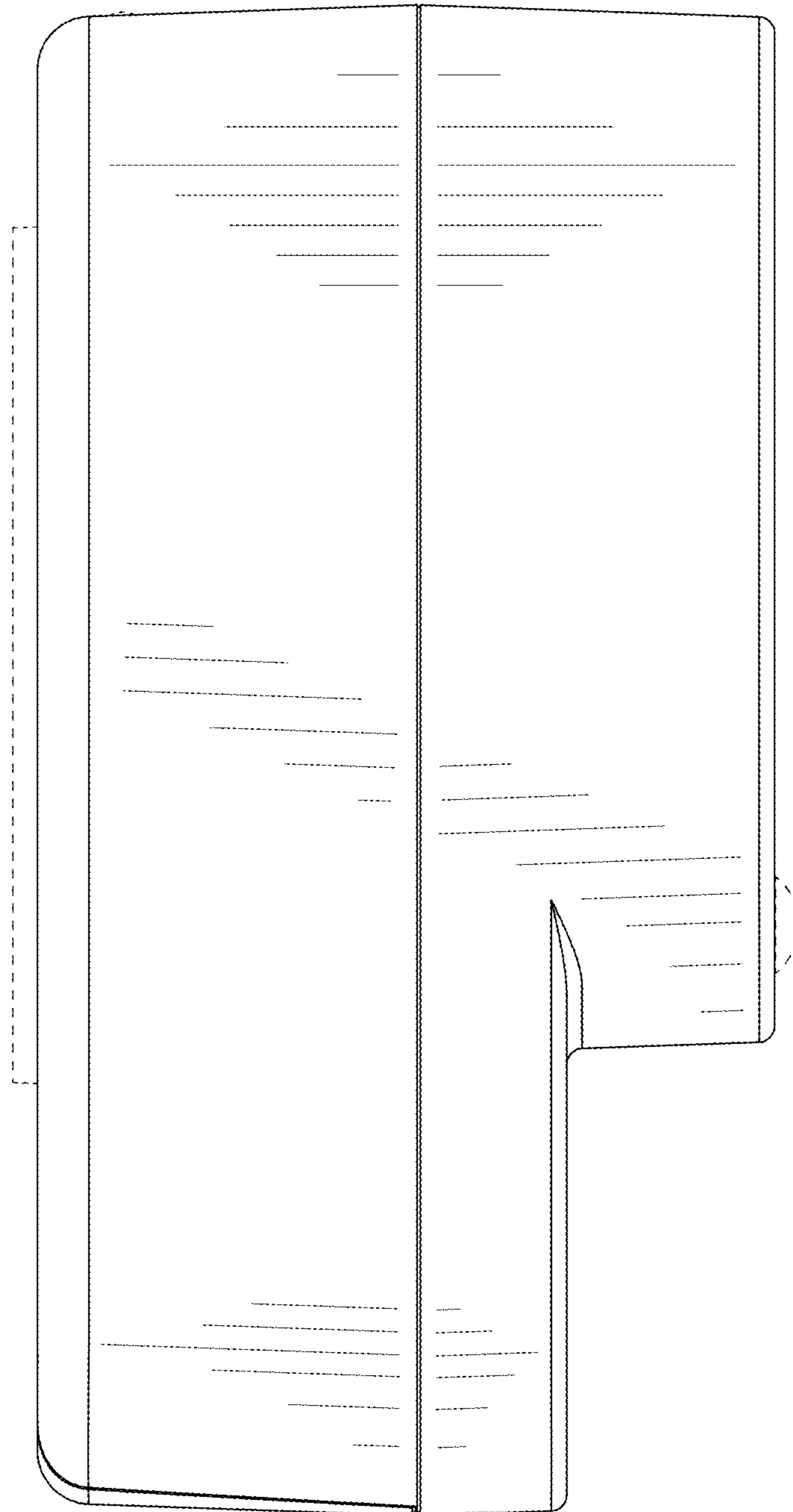

FIG. 5

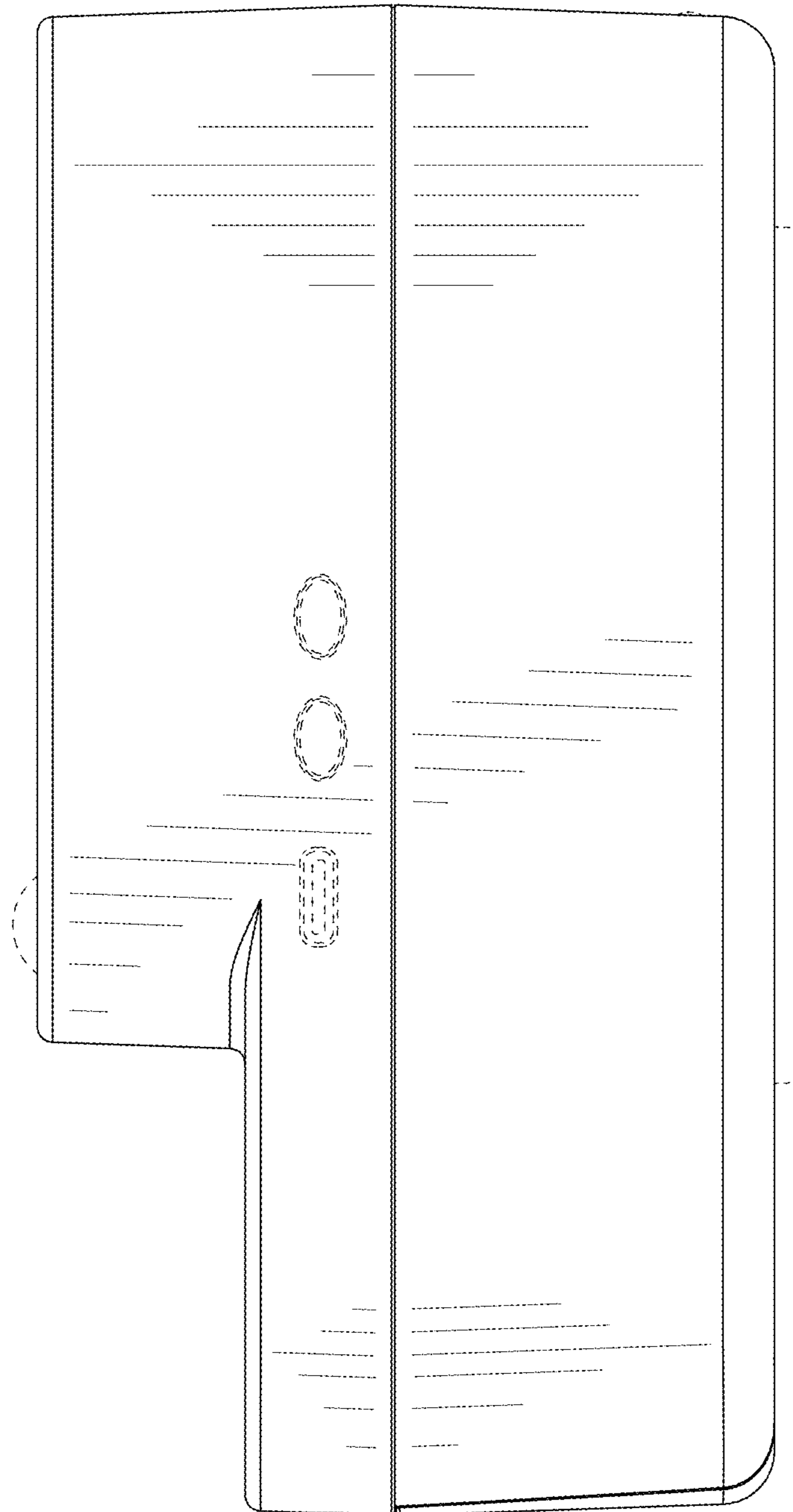

FIG. 6

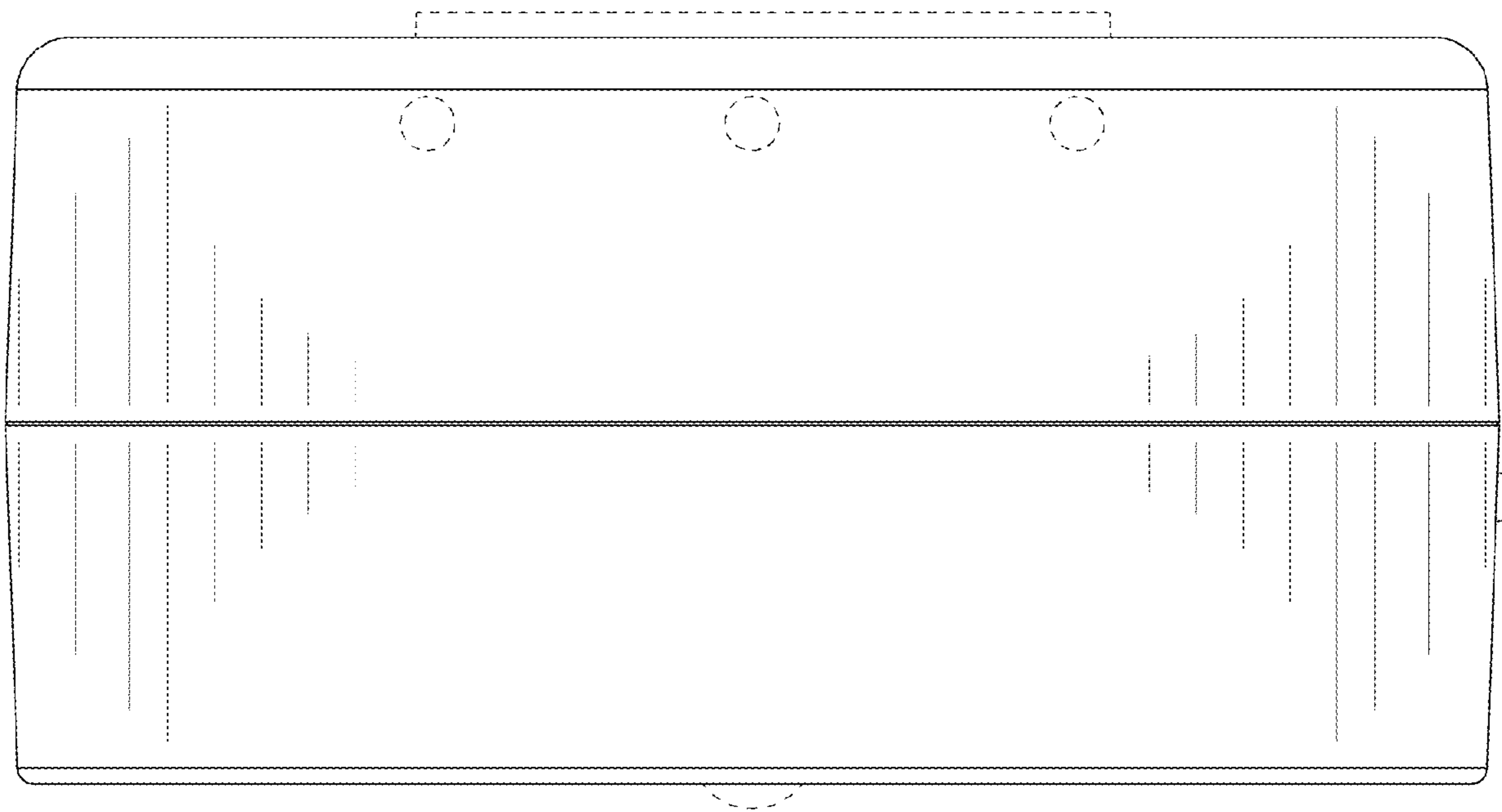

FIG. 7

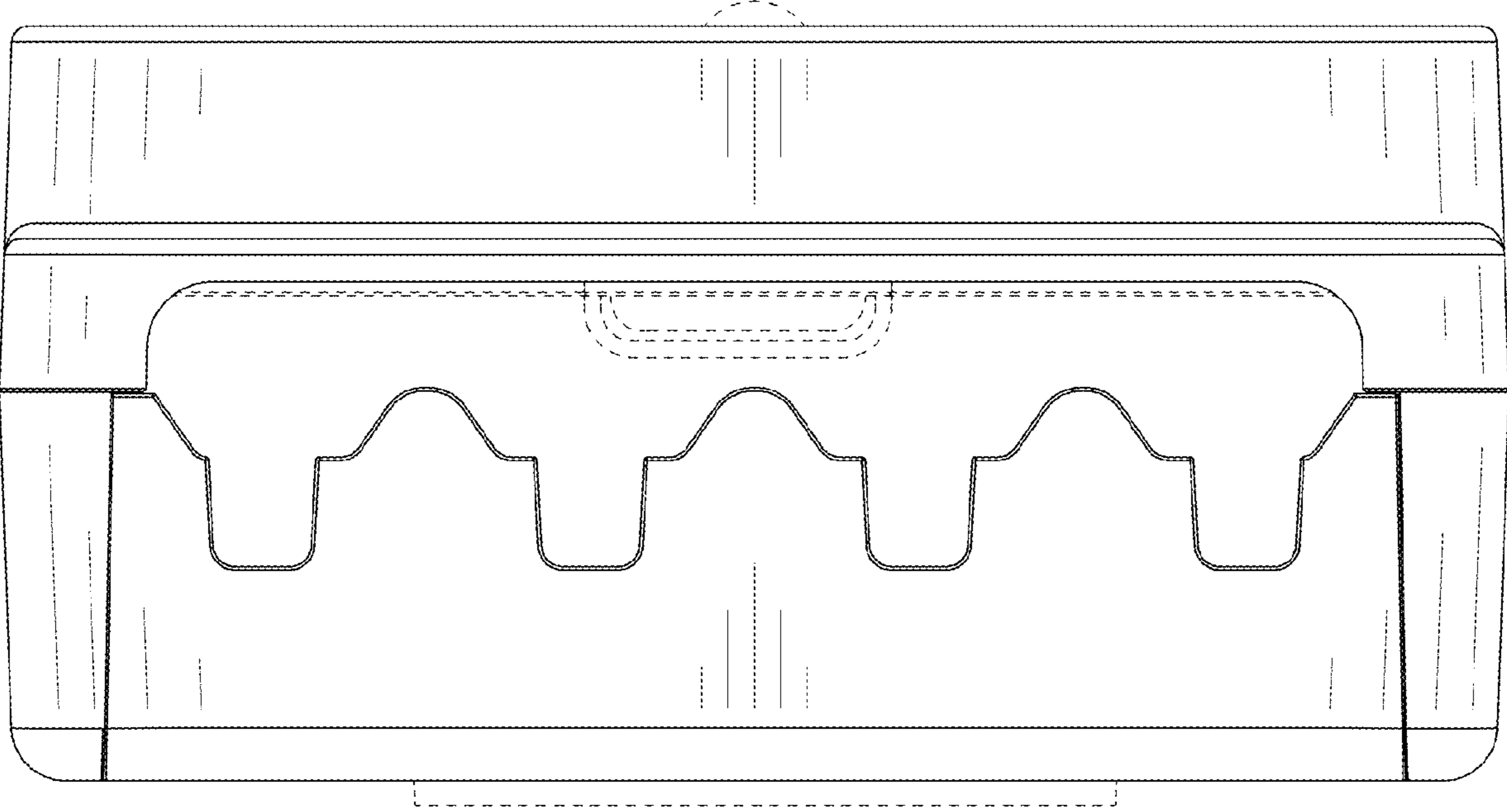

FIG. 8

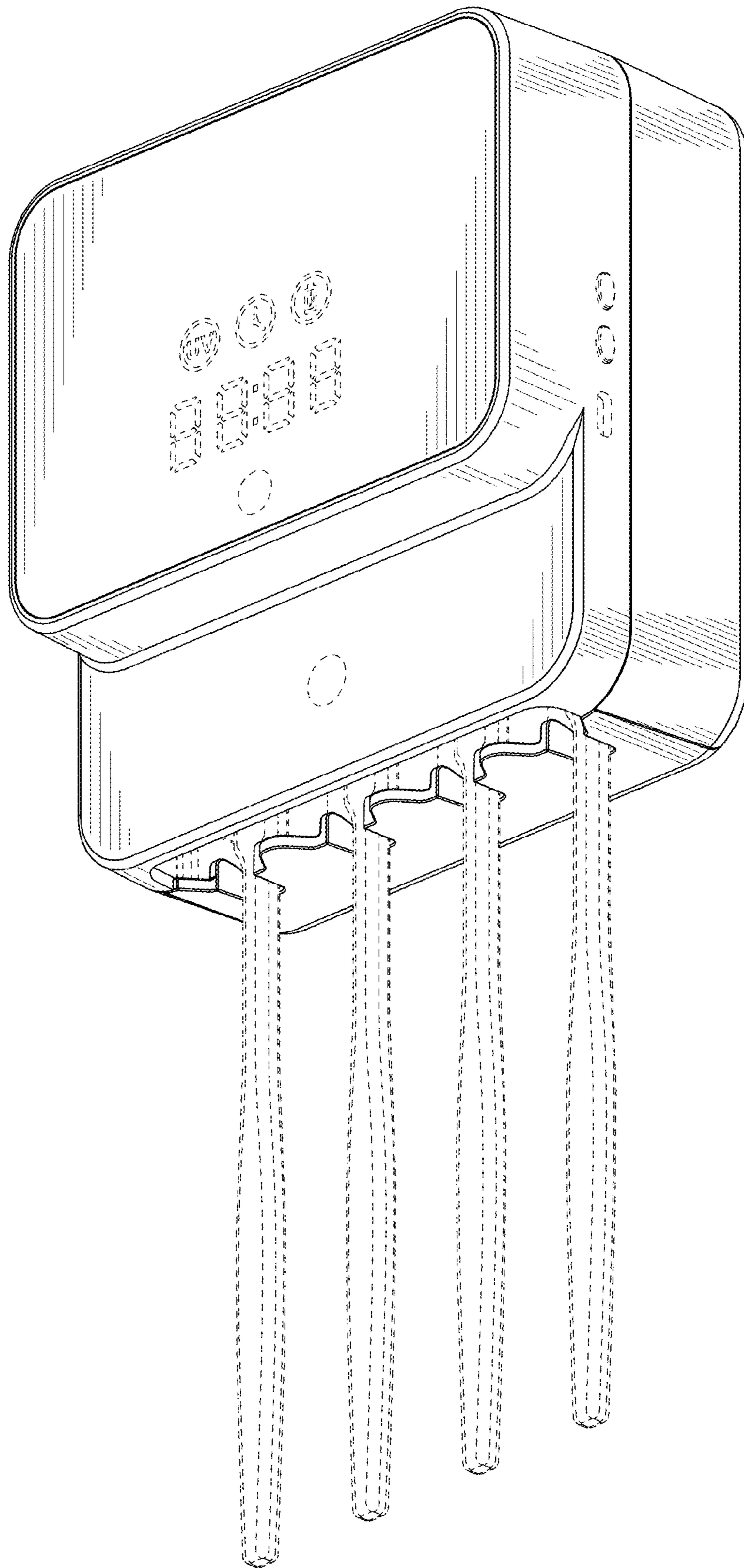

FIG. 9