



US00D970034S

(12) **United States Design Patent** (10) **Patent No.:** **US D970,034 S**  
**Schavemaker et al.** (45) **Date of Patent:** **\*\* Nov. 15, 2022**

(54) **DEVICE FOR INDUCING MICROFLUIDIC FLOW**

(71) Applicant: **Mimetas B.V.**, Leiden (NL)

(72) Inventors: **Frederik Schavemaker**, Leiden (NL);  
**Sebastiaan Johannes Trietsch**, Leiden (NL); **Arnaud Nicolas**, Leiden (NL)

(73) Assignee: **Mimetas B.V.**

(\*\*) Term: **15 Years**

(21) Appl. No.: **35/510,512**

(22) Filed: **May 15, 2019**

(80) **Hague Agreement Data**

Int. Filing Date: **May 15, 2019**

Int. Reg. No.: **DM/210546**

Int. Reg. Date: **May 15, 2019**

Int. Reg. Pub. Date: **Oct. 9, 2020**

(51) **LOC (13) Cl.** ..... **24-02**

(52) **U.S. Cl.**

USPC ..... **D24/216; D24/232**

(58) **Field of Classification Search**

USPC ..... D24/107, 108, 121, 185, 187, 207, 216,  
D24/219, 220, 223-227, 230-233, 229,  
D24/188

CPC ..... B01L 3/502715; B01L 3/50853; B01L  
2300/0645; B01L 2300/069; B01L  
2300/0829; G01N 27/128; G01N 27/026

See application file for complete search history.

(56) **References Cited**

**U.S. PATENT DOCUMENTS**

D231,570 S \* 4/1974 Greenwood ..... D24/188

D745,182 S \* 12/2015 Parsons ..... D24/231

D749,381 S \* 2/2016 Magri ..... D7/701  
D825,078 S \* 8/2018 Osmus ..... D24/232  
D898,216 S \* 10/2020 Nicolas ..... D24/216  
D919,835 S \* 5/2021 Morkunas ..... D24/233  
D934,432 S \* 10/2021 Lopez ..... D24/188  
2020/0290039 A1 \* 9/2020 Garg ..... B01L 3/502715  
2020/0393397 A1 \* 12/2020 Vulto ..... G01N 27/026

**OTHER PUBLICATIONS**

Royal Society of Chemistry. High throughput transepithelial electrical resistance (TEER) measurements on perfused membrane-free epithelia. May 7, 2021. <https://pubs.rsc.org/en/content/articlelanding/2021/lc/d0lc00770f#!divAbstract> (Year: 2021).\*

\* cited by examiner

*Primary Examiner* — Darcey E Gottschalk

(74) *Attorney, Agent, or Firm* — Miller & Martin PLLC

(57) **CLAIM**

The ornamental design for a device for inducing microfluidic flow, as shown and described.

**DESCRIPTION**

1. Device for inducing microfluidic flow  
Fig. 1.1 is a perspective view of a device for inducing microfluidic flow, showing our new design;  
Fig. 1.2 is a top plan view thereof;  
Fig. 1.3 is a bottom plan view thereof;  
Fig. 1.4 is a front elevation view thereof;  
Fig. 1.5 is a rear side elevation view thereof;  
Fig. 1.6 is a left side elevation view thereof; and  
Fig. 1.7 is a right side elevation view thereof.

In the reproductions, the gray color wash depicts portions of the device for inducing microfluidic flow that form no part of the claim.

**1 Claim, 7 Drawing Sheets**

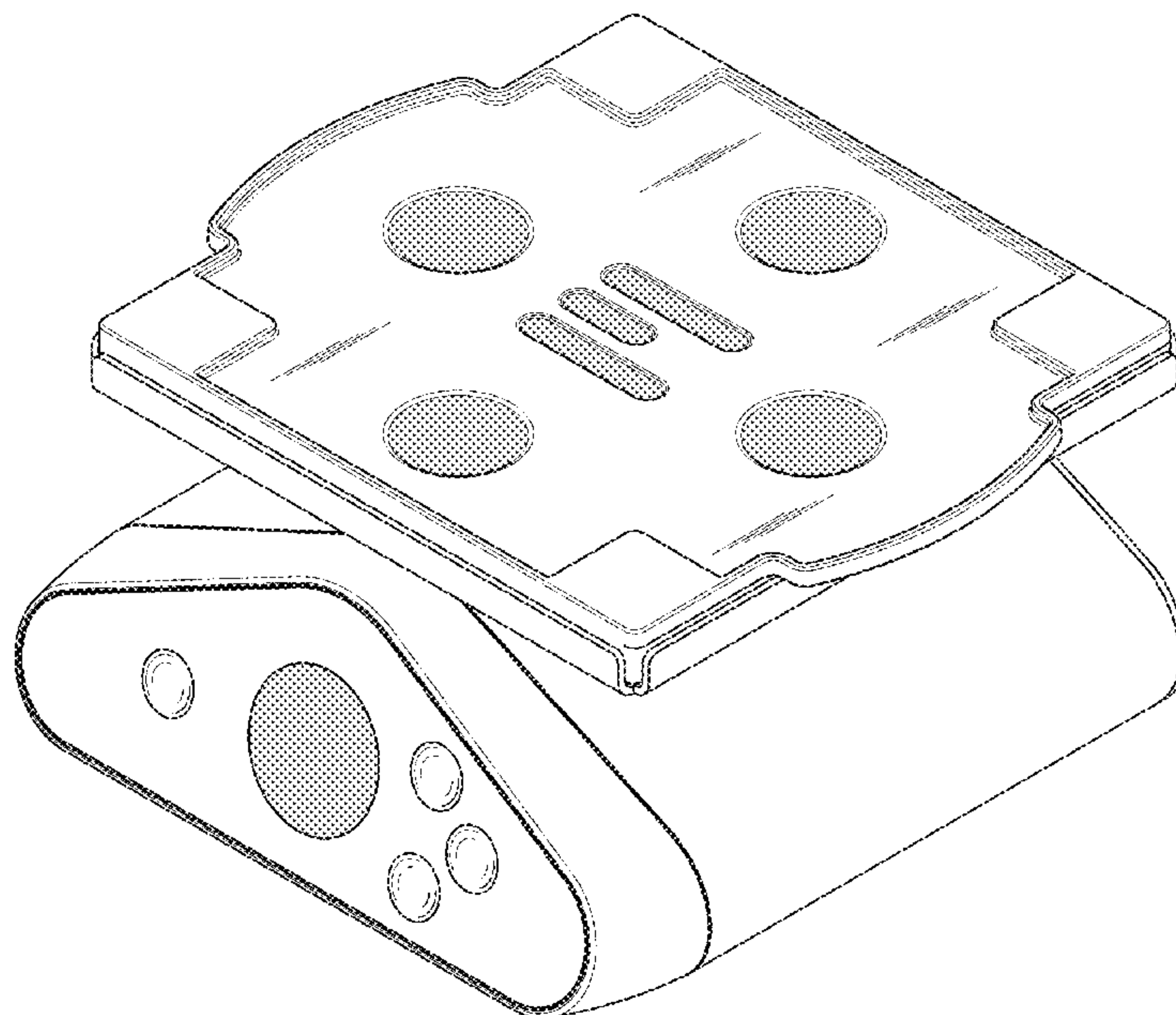

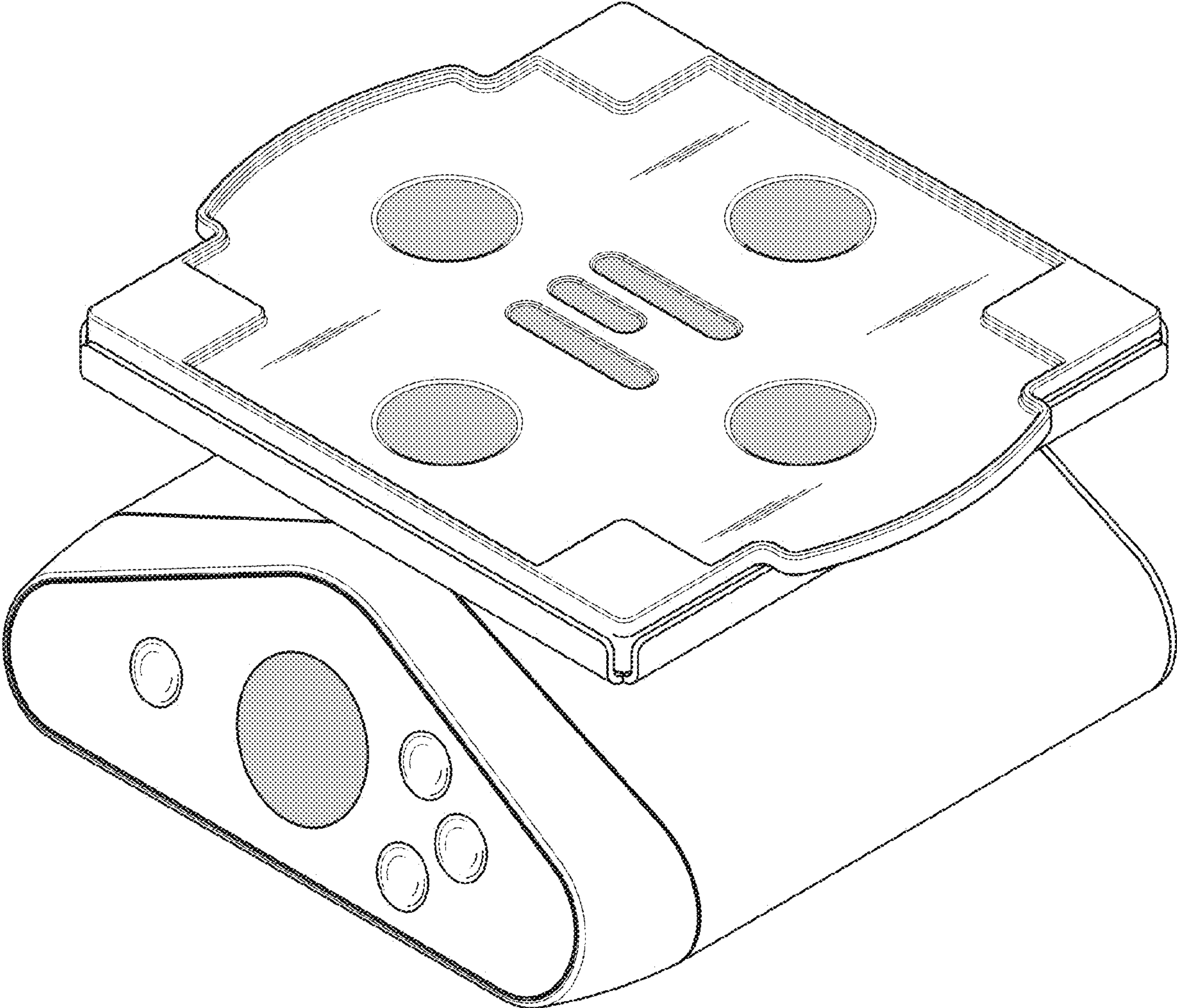

FIG. 1.1



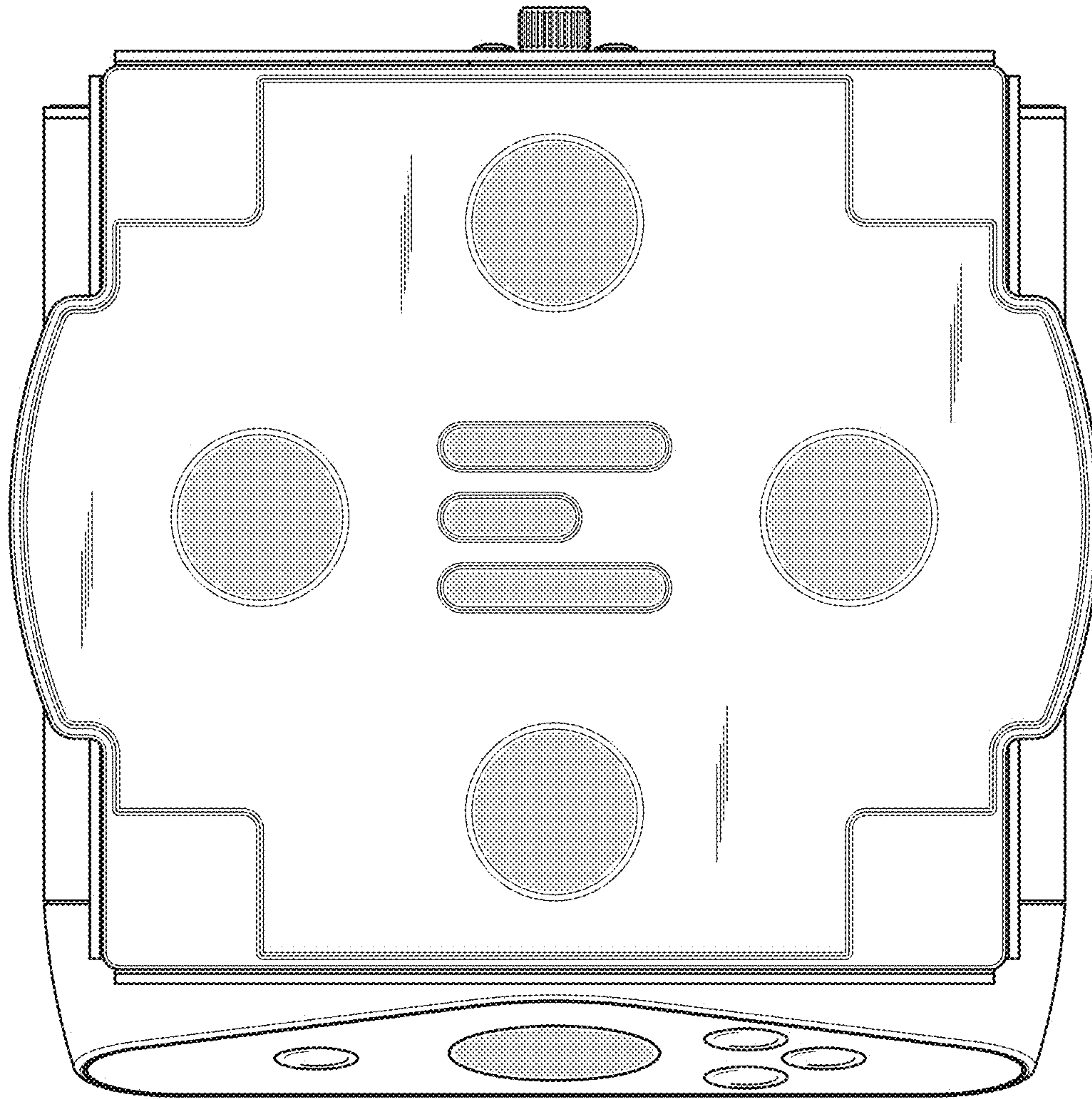

FIG. 1.2

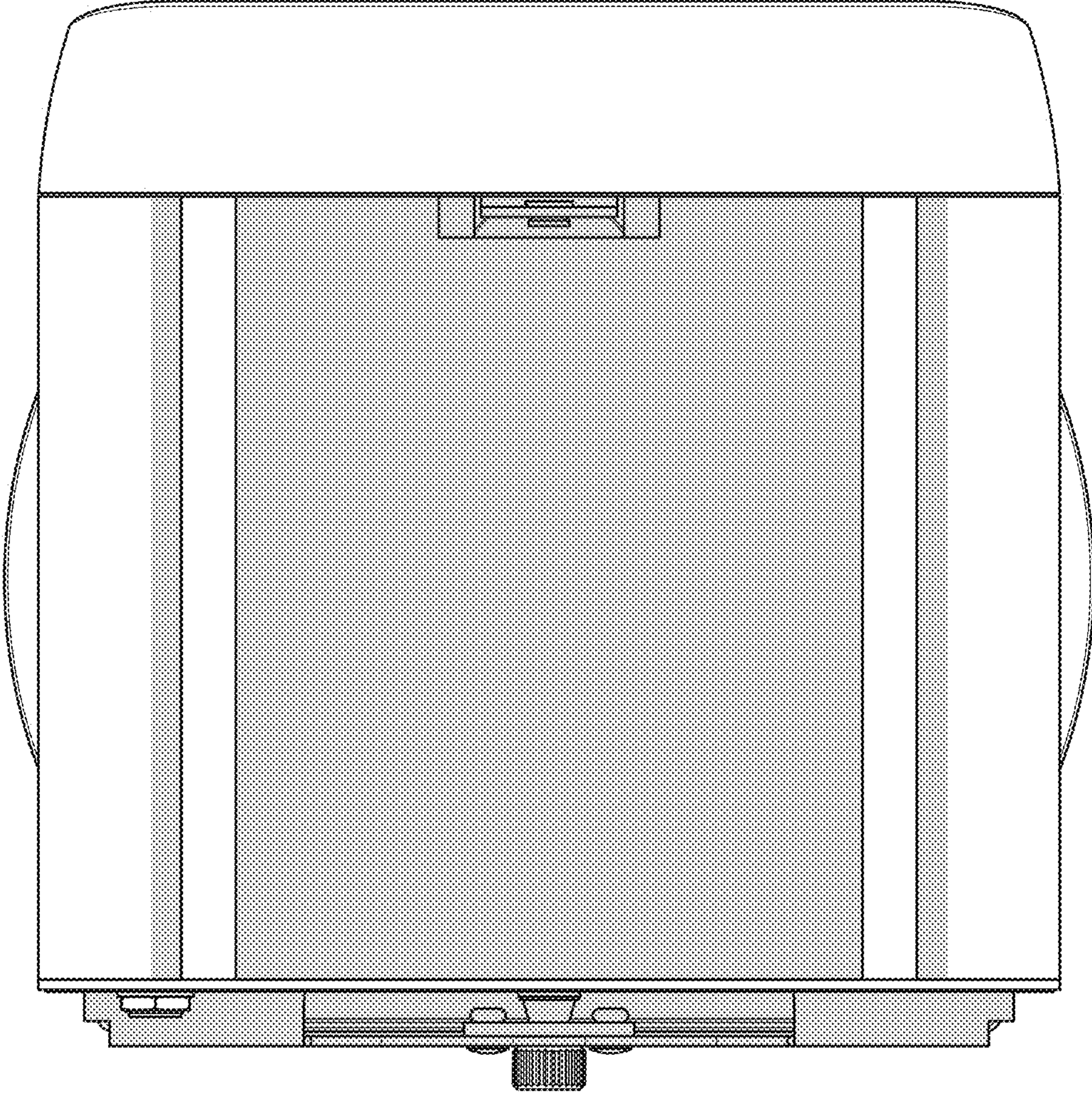

FIG. 1.3

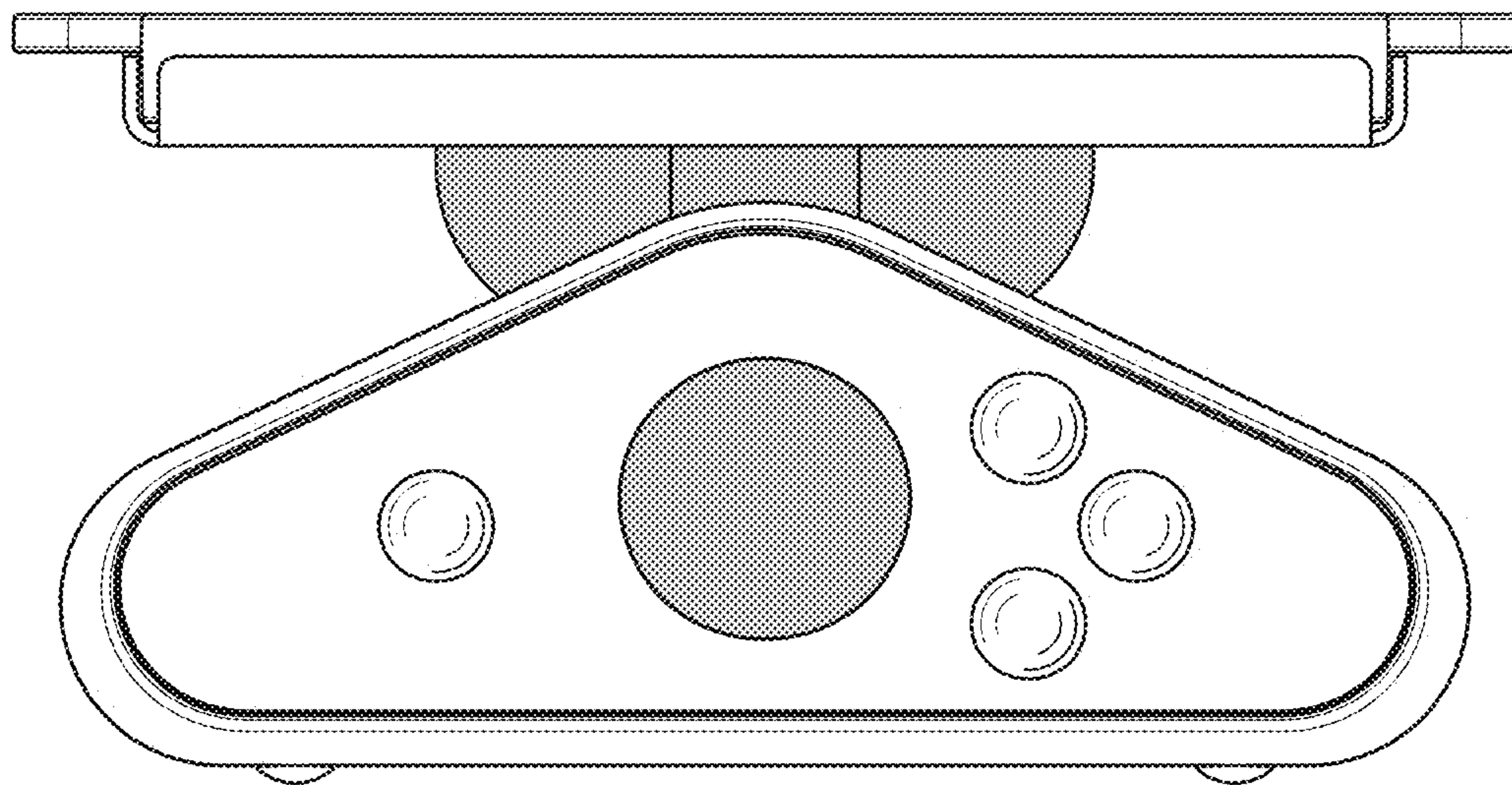

FIG. 1.4



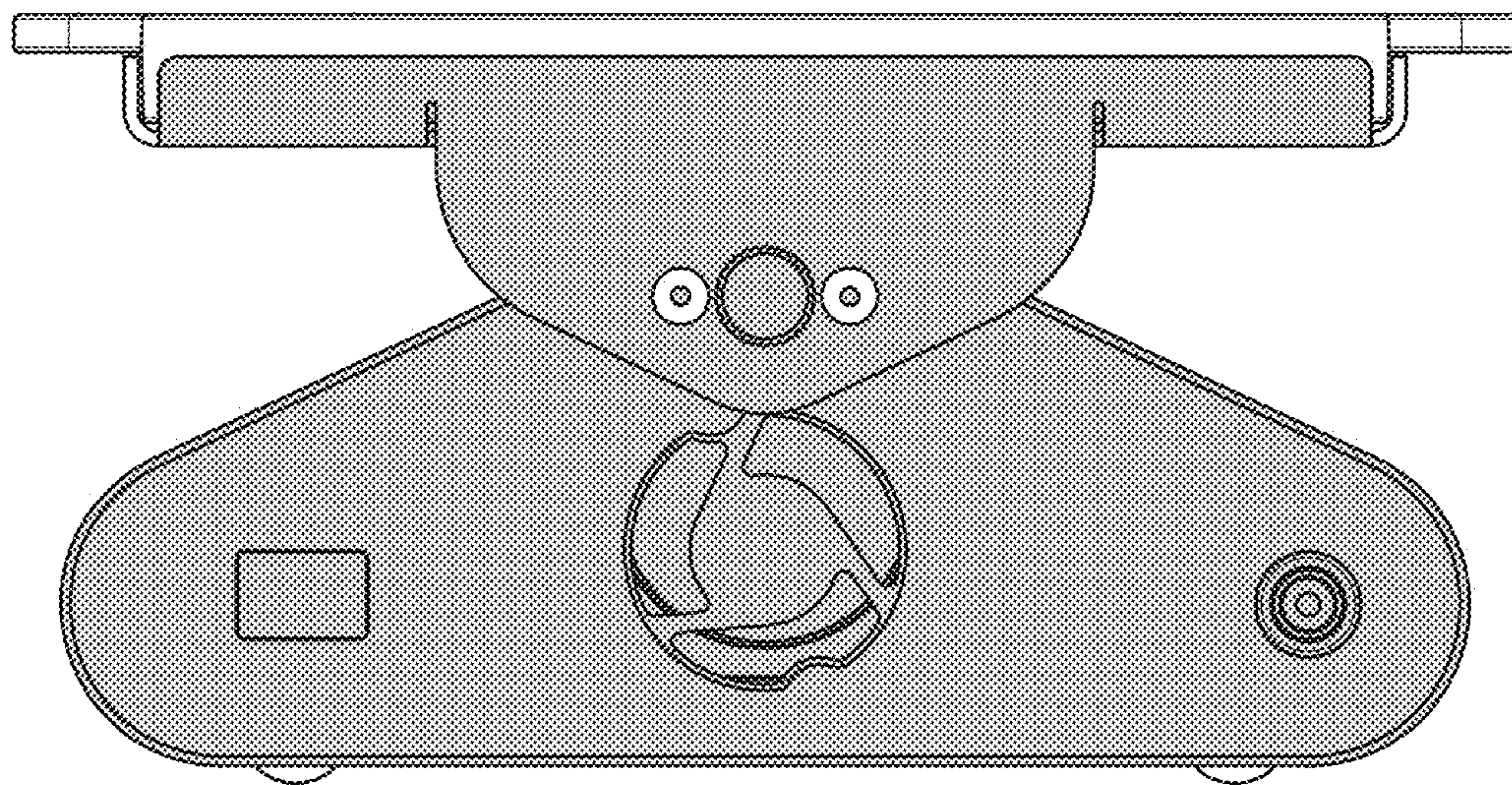

FIG. 1.5

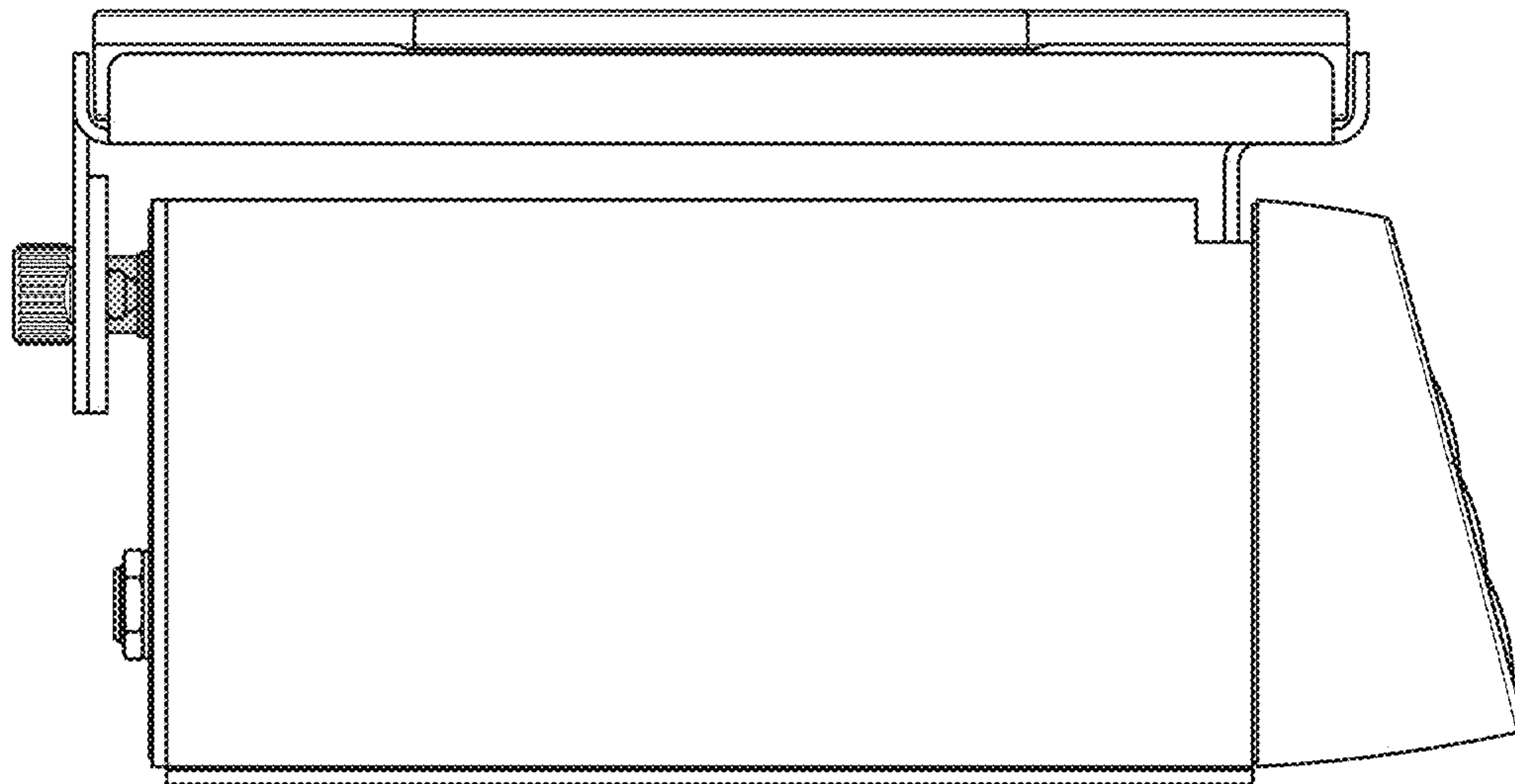

FIG. 1.6

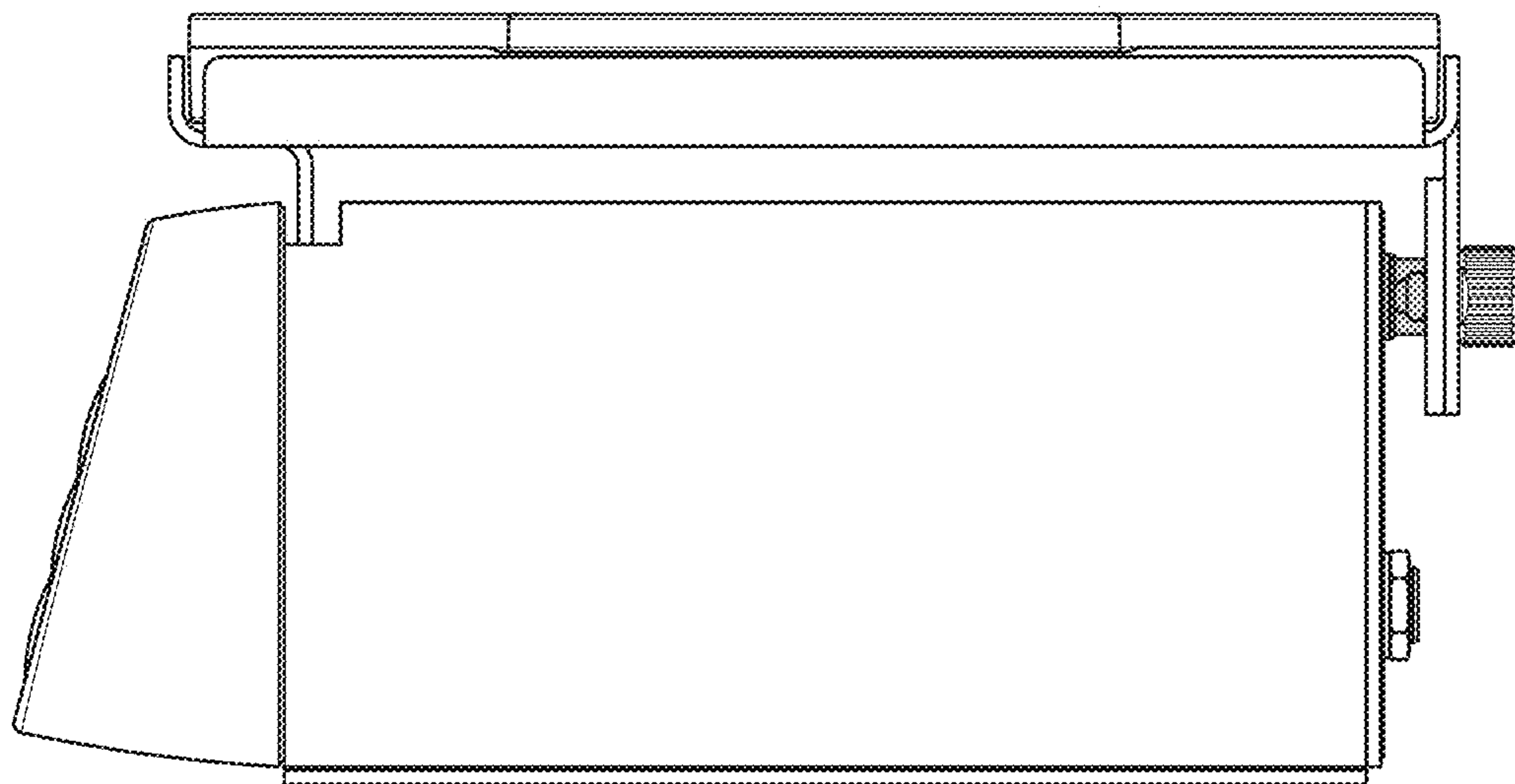

FIG. 1.7