



US00D96996S

(12) **United States Design Patent** (10) **Patent No.:** **US D969,996 S**
Rosen et al. (45) **Date of Patent:** **** Nov. 15, 2022**

(54) **SUCTION HANDPIECE TIP**

FOREIGN PATENT DOCUMENTS

(71) Applicant: **LUMENIS LTD.**, Yokneam (IL)

GB 6141149 * 6/2021

(72) Inventors: **Silvio Rosen**, Yokneam (IL); **Arkady Khachaturov**, Haifa (IL)

GB 6141151 * 6/2021

GB 6141157 * 6/2021

(73) Assignee: **Lumenis Ltd.**

(**) Term: **15 Years**

OTHER PUBLICATIONS

(21) Appl. No.: **29/762,980**

Autoclavable Suction Tip Sleeves, Premium Plus UK, [Post date Sep. 24, 2020], [Site seen Jun. 22, 2022], Seen at URL: <https://www.premiumplusuk.com/product/290-autoclavable-suction-tip-sleeves/> (Year: 2020).*

(22) Filed: **Dec. 20, 2020**

(Continued)

(51) **LOC (13) Cl.** **24-02**

Primary Examiner — Natasha Vujcic

(52) **U.S. Cl.**

Assistant Examiner — Gilbert B Ford

USPC **D24/112**

(74) *Attorney, Agent, or Firm* — Seager, Tufte & Wickhem, LLP

(58) **Field of Classification Search**

USPC D24/108, 111, 112, 114, 127, 129, 130, D24/133, 147, 152, 186, 214, 215

CPC A61B 1/00094; A61M 2005/1583; A61M 2005/1586; A61M 2005/3277; A61M 5/158; A61M 5/1582; A61M 5/3243

(57) **CLAIM**

See application file for complete search history.

The ornamental design for a suction handpiece tip, as shown and described.

(56) **References Cited**

DESCRIPTION

U.S. PATENT DOCUMENTS

D550,840 S *	9/2007	Anderson	D24/129
D610,258 S *	2/2010	Robinson	D24/146
D663,838 S *	7/2012	Mastri	D24/146
D692,143 S *	10/2013	shahidi bonjar	D24/176
D708,745 S *	7/2014	Arnett	D24/145
D746,456 S *	12/2015	Harrison	D24/146
9,402,975 B2 *	8/2016	Shevgoor	A61M 25/0015
D792,578 S *	7/2017	Jones	D24/113
D803,023 S *	11/2017	Anderson	D8/86
9,827,007 B2 *	11/2017	Begg	A61B 10/0266
D811,587 S *	2/2018	Mitchell	D24/112
D811,602 S *	2/2018	Mao	D24/186
D847,360 S *	4/2019	Levi	D24/214
D861,160 S *	9/2019	Broyles	D24/127
D879,957 S *	3/2020	Zabar	D24/130

FIG. 1 is a front, top perspective view of a suction handpiece tip;
FIG. 2 is a Bottom Rear Perspective View of the new design.
FIG. 3 is a Left Side View of the new design.
FIG. 4 is a Right Side View of the new design.
FIG. 5 is a Top View of the new design.
FIG. 6 is a Bottom View of the new design.
FIG. 7 is a Front View of the new design.
FIG. 8 is a Rear View of the new design; and,
FIG. 9 is a Front Perspective View with tube in broken lines.
The broken lines in the drawings illustrate portions of the suction handpiece tip and form no part of the claimed design.

(Continued)

1 Claim, 9 Drawing Sheets

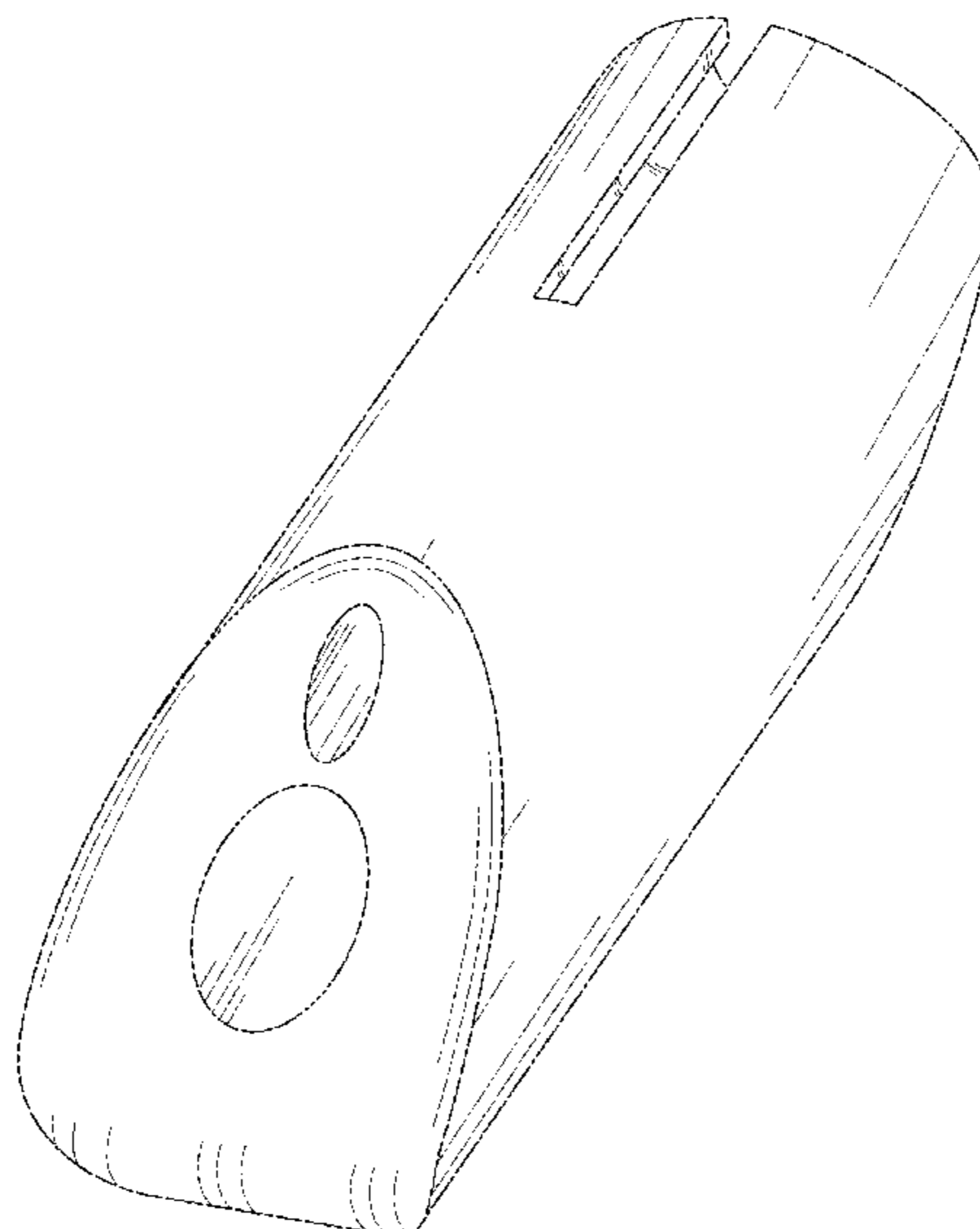

(56)

References Cited

U.S. PATENT DOCUMENTS

D896,374 S * 9/2020 Julian D24/130
D910,848 S * 2/2021 Garcia D24/145

OTHER PUBLICATIONS

3 pieces Dental Aspirator Weak Suction Tube Tip Stainless Steel Autoclavable Dental Implant Surgical Tool, Sowdane, aliexpress.com, [Post date unknown], [Site seen Jun. 22, 2022], Seen at URL: <https://www.aliexpress.com/item/2251832649629839.html?gatewayAdapt=4itemAdapt> (Year: 2022).*

* cited by examiner

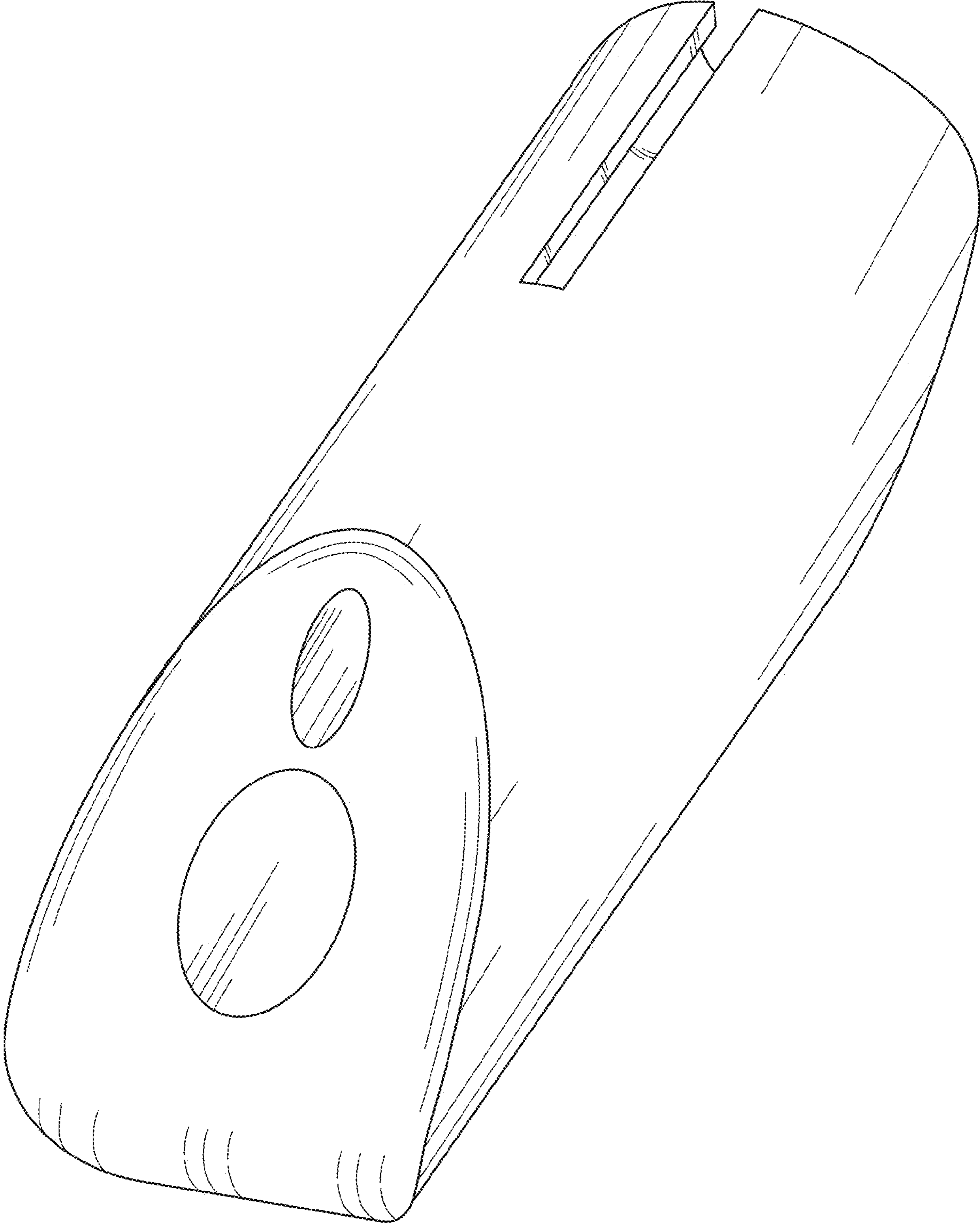

FIG. 1

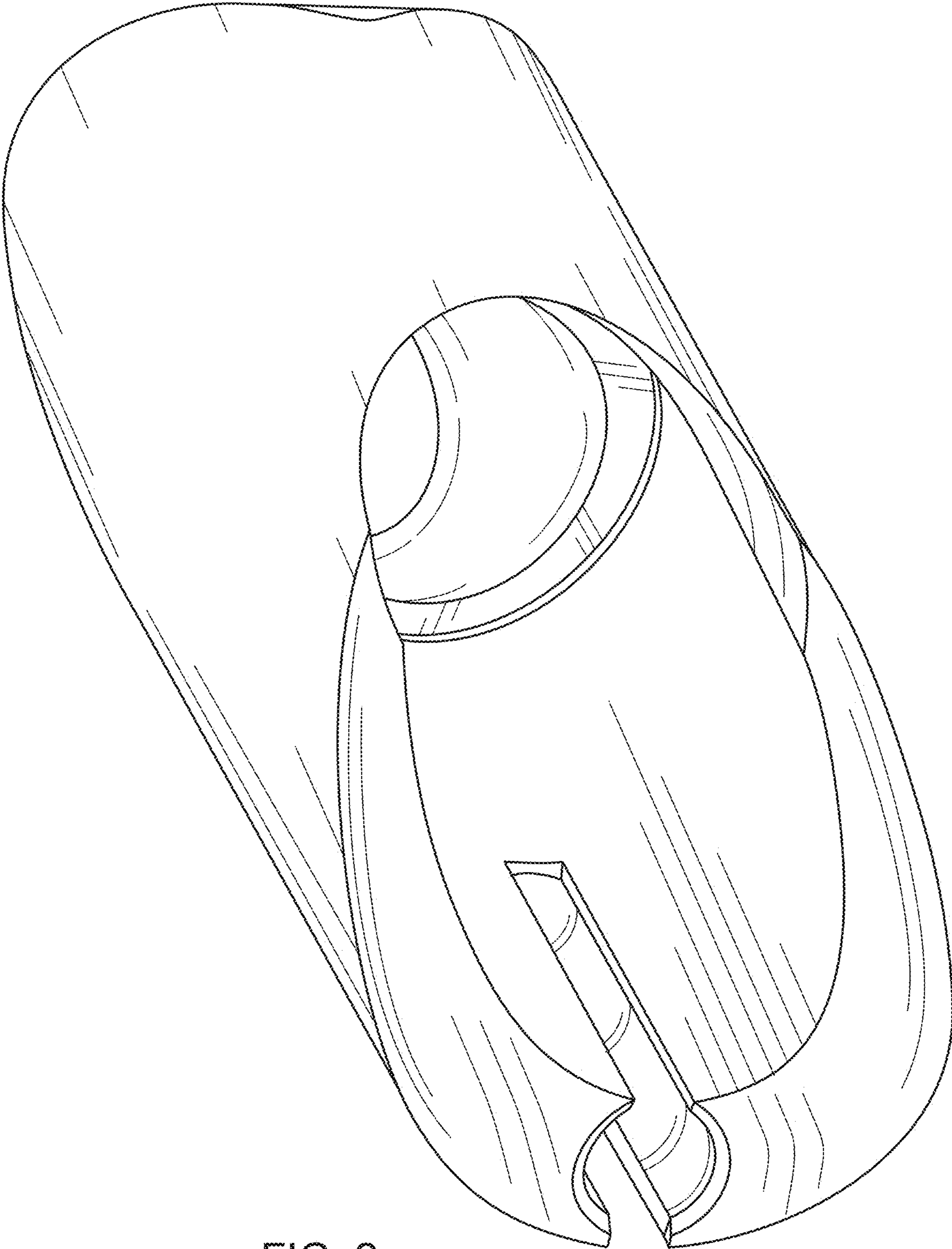

FIG. 2

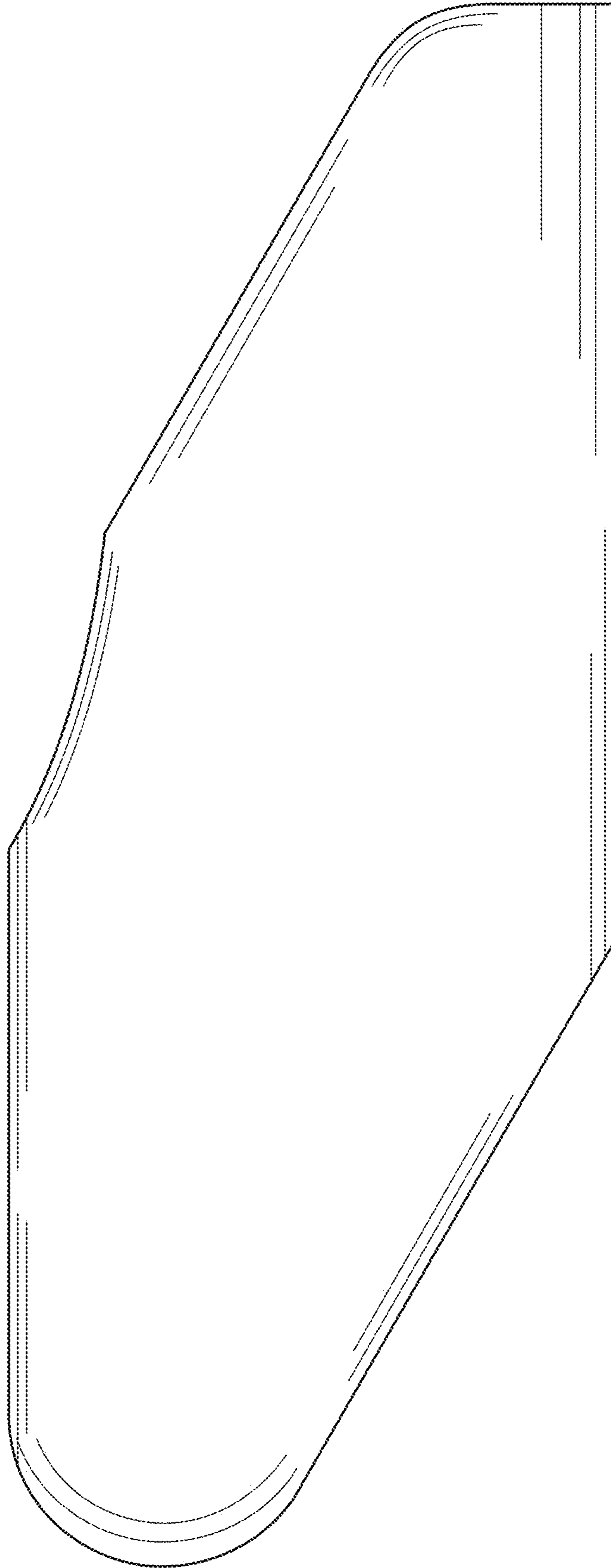

FIG. 3

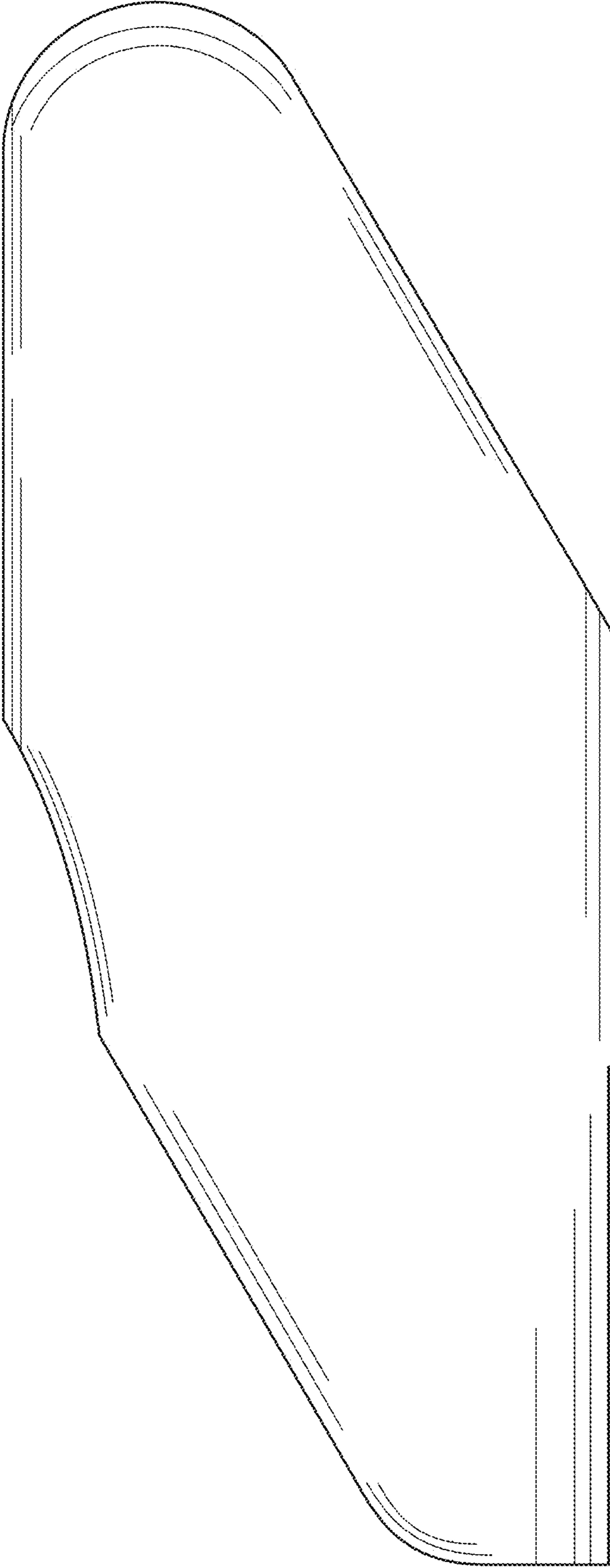

FIG. 4

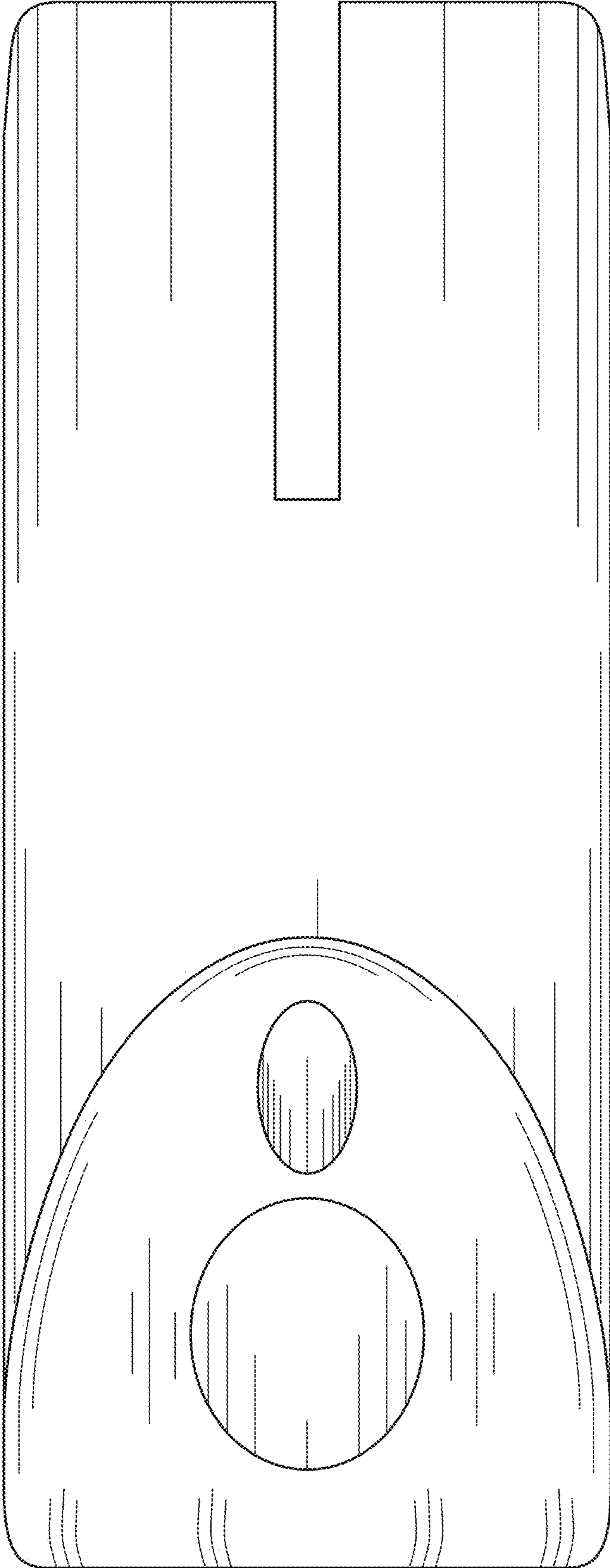

FIG. 5

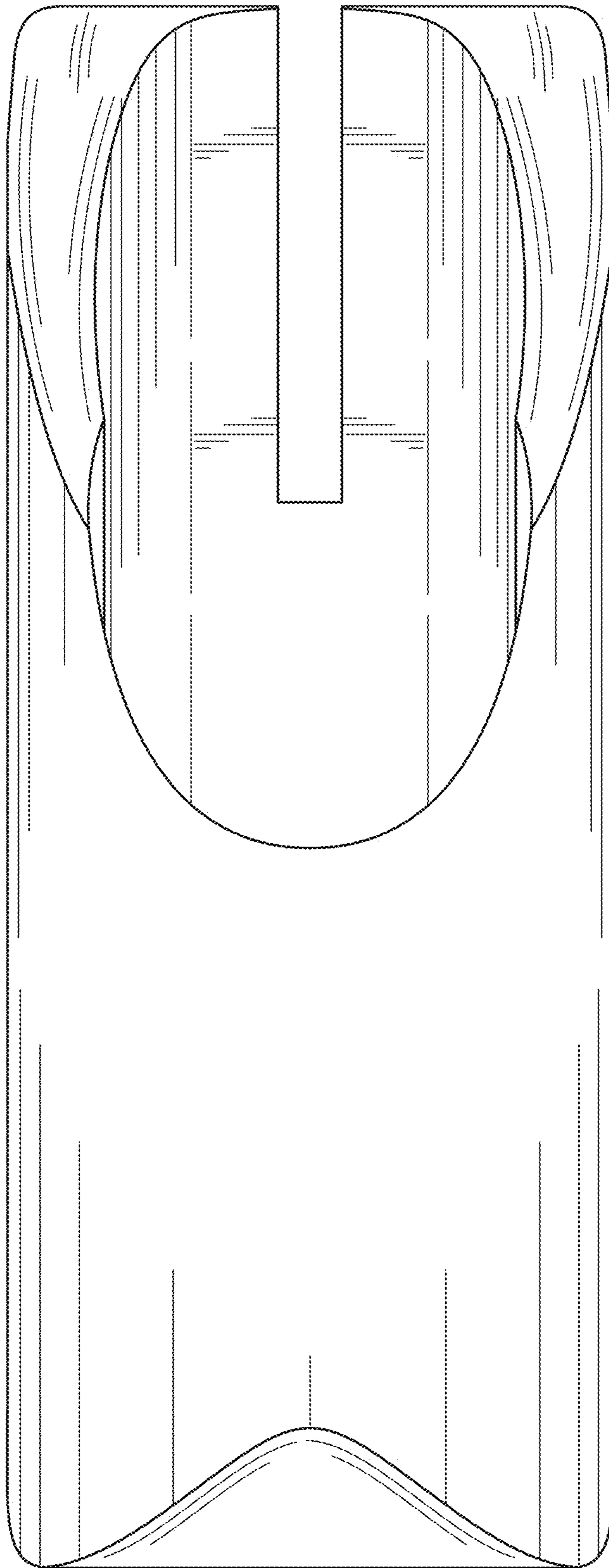

FIG. 6

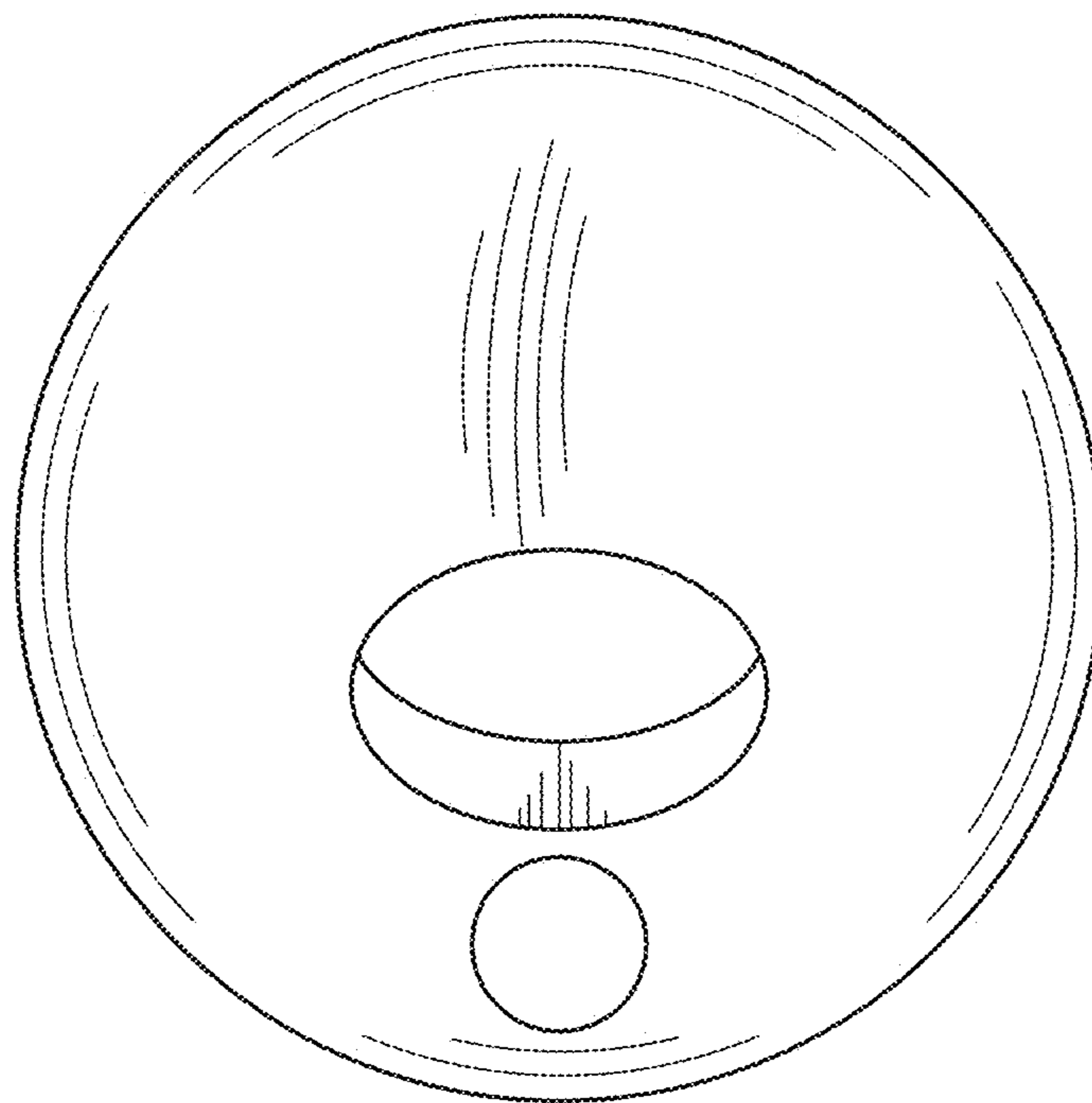

FIG. 7

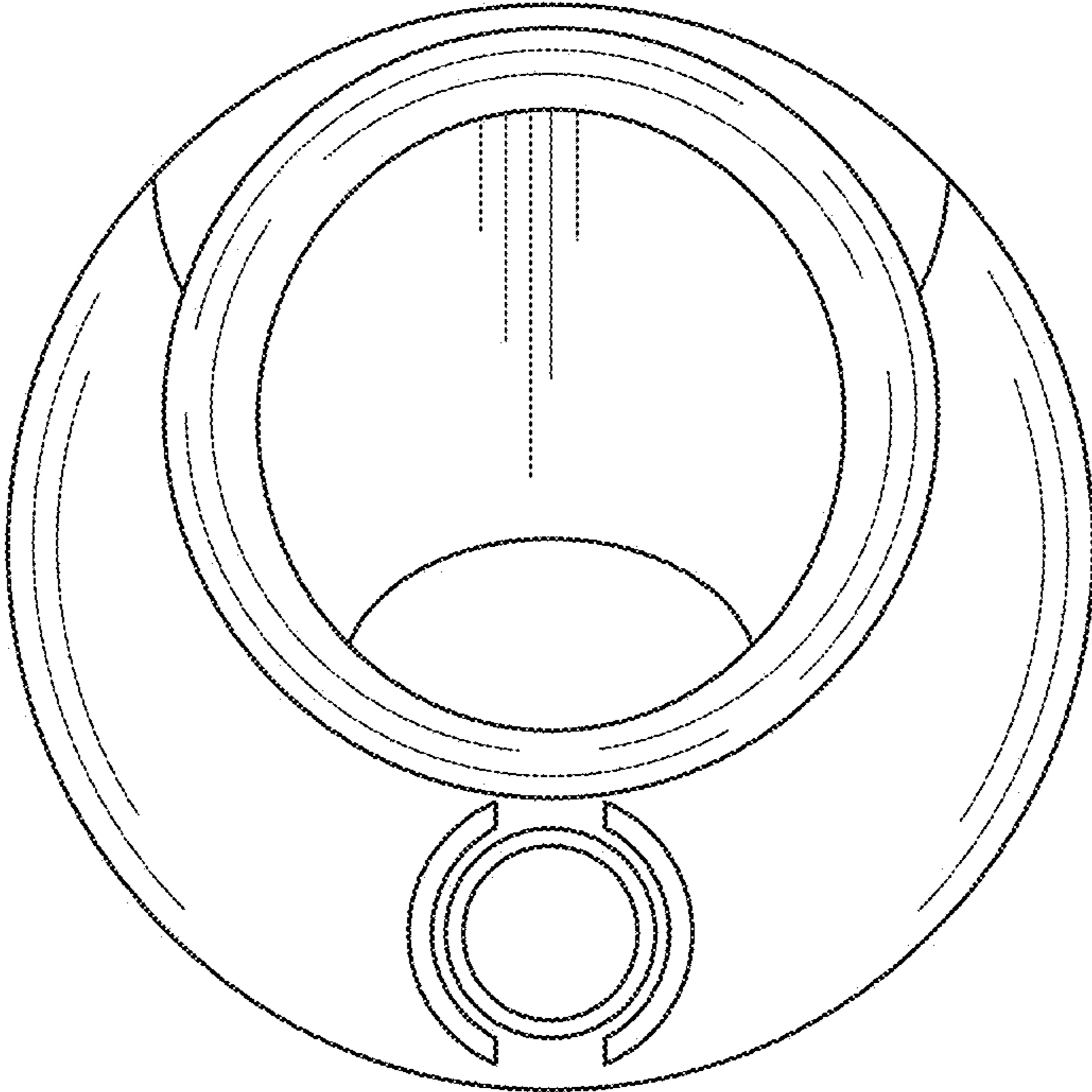

FIG. 8

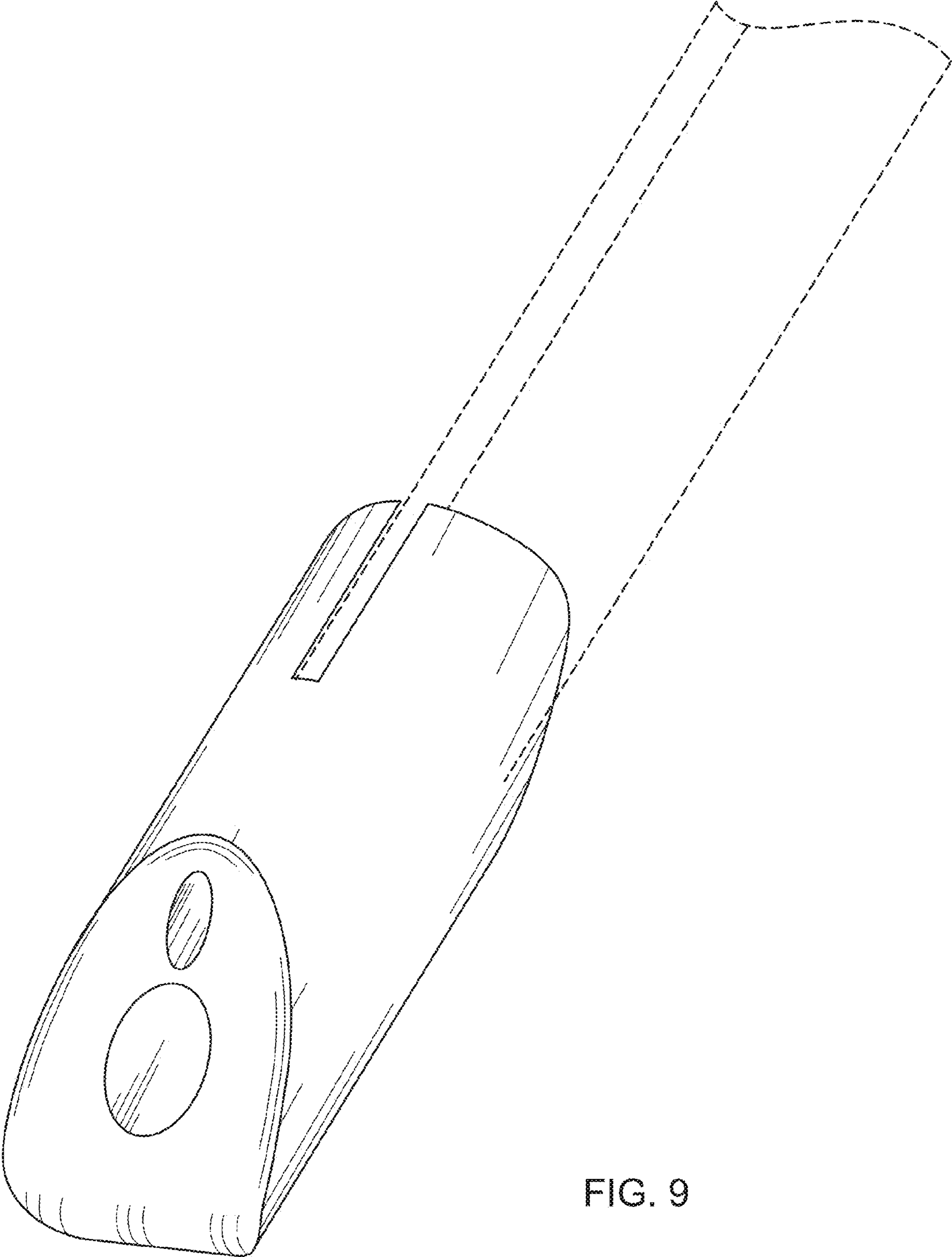

FIG. 9