



US00D969944S

(12) **United States Design Patent** (10) **Patent No.:** **US D969,944 S**  
**Tai** (45) **Date of Patent:** **\*\* Nov. 15, 2022**

(54) **TREADMILL SLAT**  
(71) Applicant: **YITRON TECHNOLOGY COMPANY LIMITED**, Chiayi (TW)  
(72) Inventor: **Ming-Lung Tai**, Chiayi (TW)  
(\*\*) Term: **15 Years**  
(21) Appl. No.: **29/737,575**  
(22) Filed: **Jun. 10, 2020**  
(51) **LOC (13) Cl.** ..... **21-02**  
(52) **U.S. Cl.**  
USPC ..... **D21/694**  
(58) **Field of Classification Search**  
USPC ..... D21/669, 686, 694  
See application file for complete search history.

(56) **References Cited**  
U.S. PATENT DOCUMENTS  
D204,763 S \* 5/1966 Fulbright ..... D25/45  
D298,057 S \* 10/1988 Mahnke ..... D25/122  
(Continued)

*Primary Examiner* — Khawaja Anwar  
*Assistant Examiner* — Julice Seung Eun Oum

(57) **CLAIM**  
The ornamental design for a treadmill slat, as shown and described.

**DESCRIPTION**

FIG. 1 is a perspective view of a first treadmill slat according to the present design;  
FIG. 2 is a front view of the first treadmill slat according to the present design;  
FIG. 3 is a rear view of the first treadmill slat according to the present design;  
FIG. 4 is a left side view of the first treadmill slat according to the present design;

FIG. 5 is a right side view of the first treadmill slat according to the present design;  
FIG. 6 is a top view of the first treadmill slat according to the present design;  
FIG. 7 is a bottom view of the first treadmill slat according to the present design;  
FIG. 8 is a perspective view of a second treadmill slat according to the present design;  
FIG. 9 is a front view of the second treadmill slat according to the present design;  
FIG. 10 is a rear view of the second treadmill slat according to the present design;  
FIG. 11 is a left side view of the second treadmill slat according to the present design;  
FIG. 12 is a right side view of the second treadmill slat according to the present design;  
FIG. 13 is a top view of the second treadmill slat according to the present design;  
FIG. 14 is a bottom view of the second treadmill slat according to the present design;  
FIG. 15 is a perspective view of a third treadmill slat according to the present design;  
FIG. 16 is a front view of the third treadmill slat according to the present design;  
FIG. 17 is a rear view of the third treadmill slat according to the present design;  
FIG. 18 is a left side view of the third treadmill slat according to the present design;  
FIG. 19 is a right-side view of the third treadmill slat according to the present design;  
FIG. 20 is a top view of the third treadmill slat according to the present design;  
FIG. 21 is a bottom view of the third treadmill slat according to the present design;  
FIG. 22 is a perspective view of a fourth treadmill slat according to the present design;  
FIG. 23 is a front view of the fourth treadmill slat according to the present design;  
FIG. 24 is a rear view of the fourth treadmill slat according to the present design;  
FIG. 25 is a left side view of the fourth treadmill slat according to the present design;  
FIG. 26 is a right-side view of the fourth treadmill slat according to the present design;

(Continued)

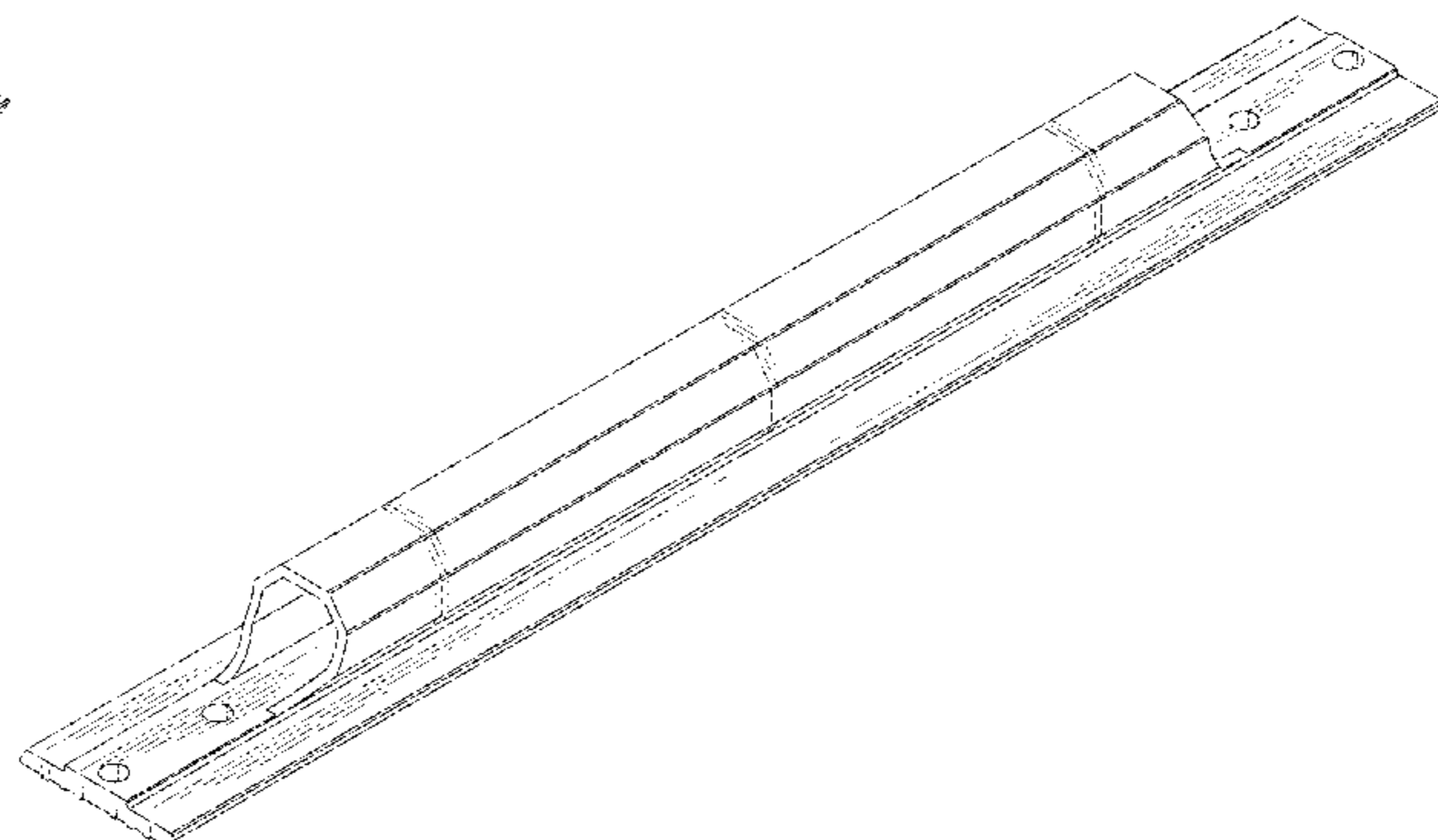
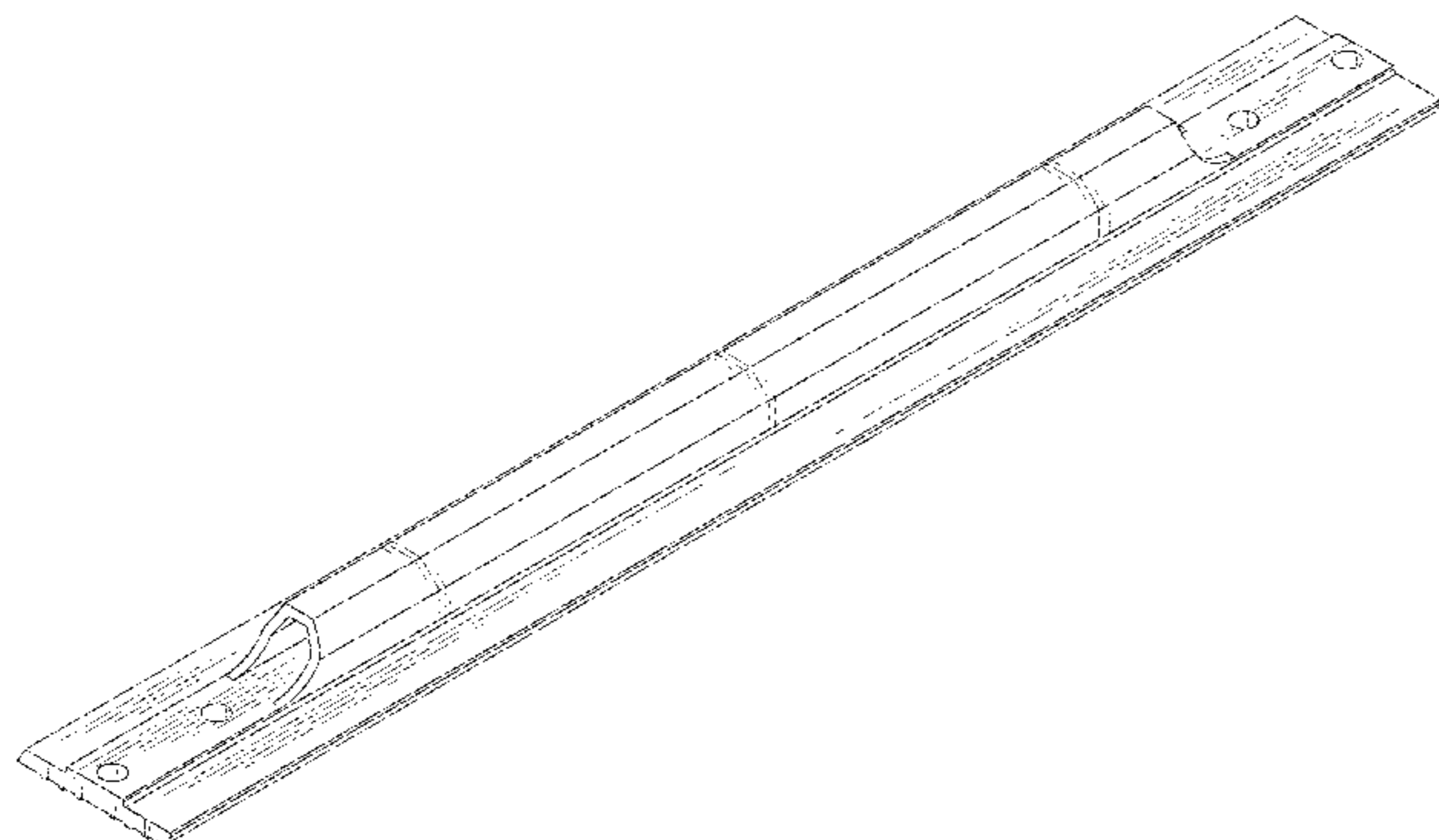

FIG. 27 is a top view of the fourth treadmill slat according to the present design;

FIG. 28 is a bottom view of the fourth treadmill slat according to the present design;

FIG. 29 is a perspective view of a fifth treadmill slat according to the present design;

FIG. 30 is a front view of the fifth treadmill slat according to the present design;

FIG. 31 is a rear view of the fifth treadmill slat according to the present design;

FIG. 32 is a left side view of the fifth treadmill slat according to the present design;

FIG. 33 is a right-side view of the fifth treadmill slat according to the present design;

FIG. 34 is a top view of the fifth treadmill slat according to the present design; and,

FIG. 35 is a bottom view of the fifth treadmill slat according to the present design.

**1 Claim, 20 Drawing Sheets**

(56)

**References Cited**

U.S. PATENT DOCUMENTS

D398,670	S	*	9/1998	Crawford	.....	D21/662
6,517,877	B2	*	2/2003	Gannon	.....	A23K 40/25 426/94
D494,006	S	*	8/2004	Zemel	.....	D7/395
D732,888	S	*	6/2015	Rose	.....	D7/395
D779,598	S	*	2/2017	Corley	.....	D21/662
D794,141	S	*	8/2017	Corley	.....	D21/662
D879,217	S	*	3/2020	Dunahay	.....	D8/354
D898,842	S	*	10/2020	Corley	.....	D21/662
D913,384	S	*	3/2021	Thiel	.....	D21/686
D949,258	S	*	4/2022	Dunahay	.....	D21/686

\* cited by examiner

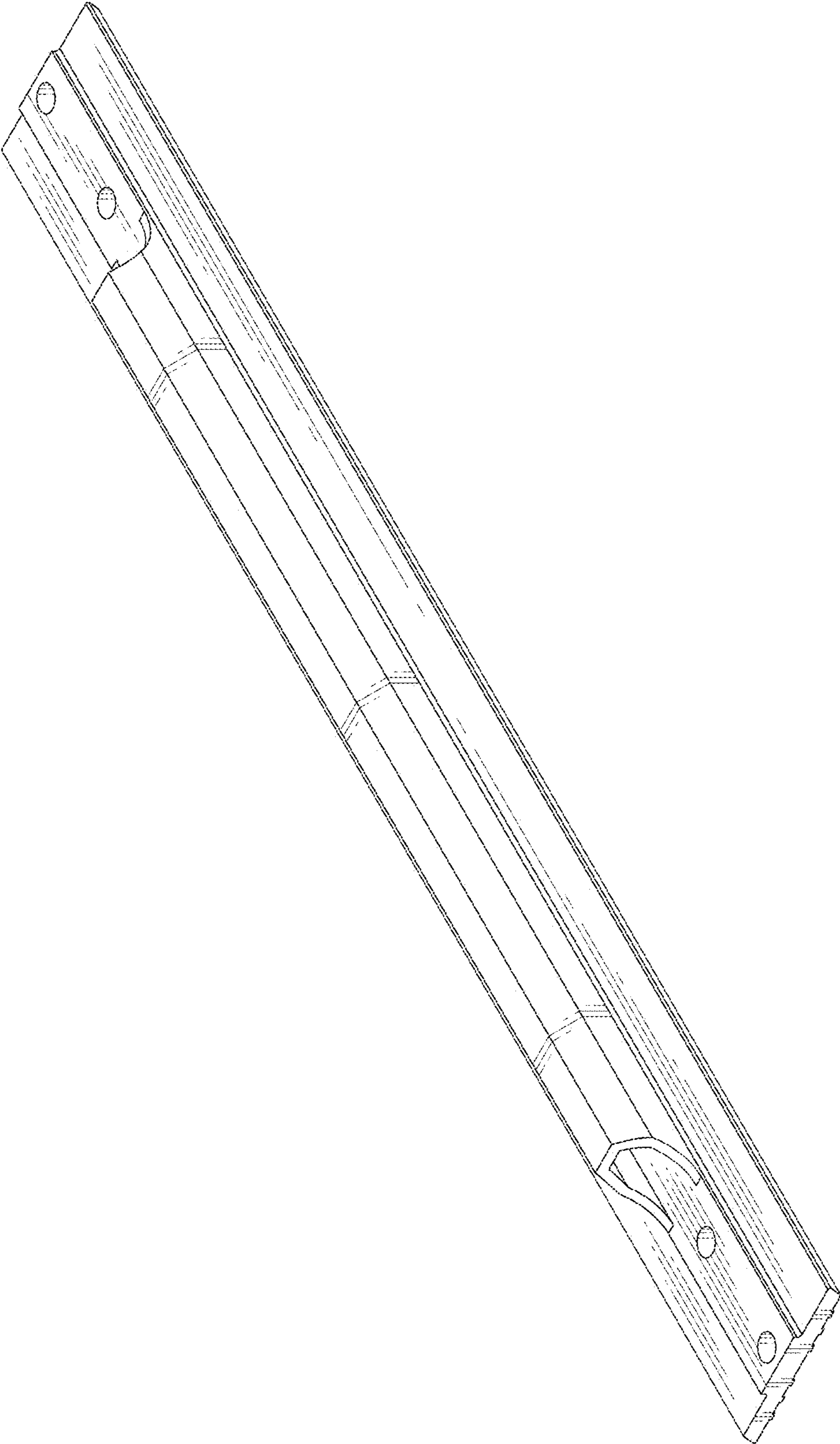

FIG. 1

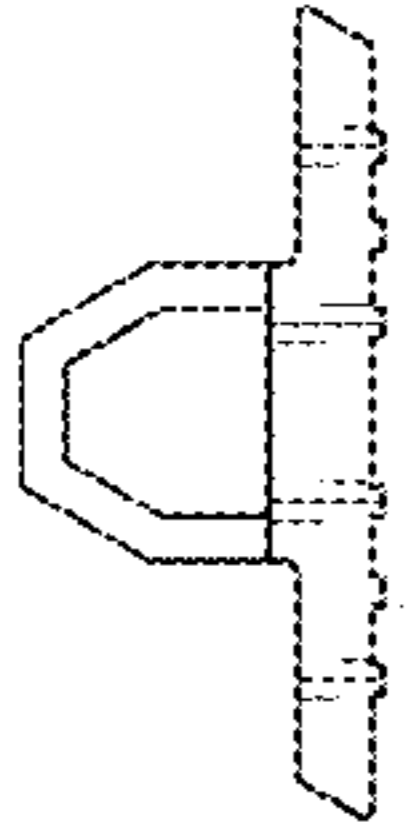

FIG. 2

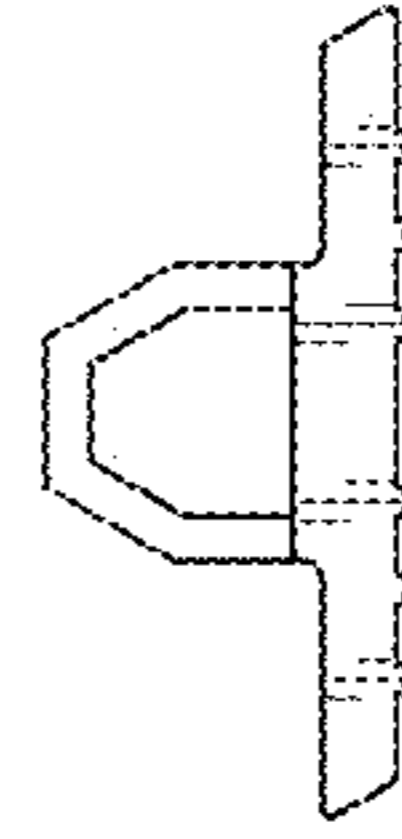

FIG. 3



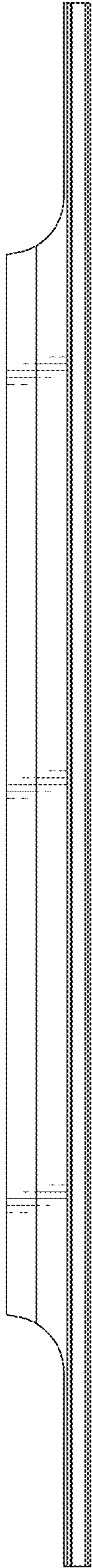

FIG. 4

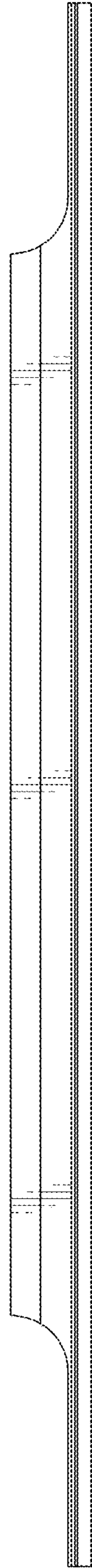

FIG. 5

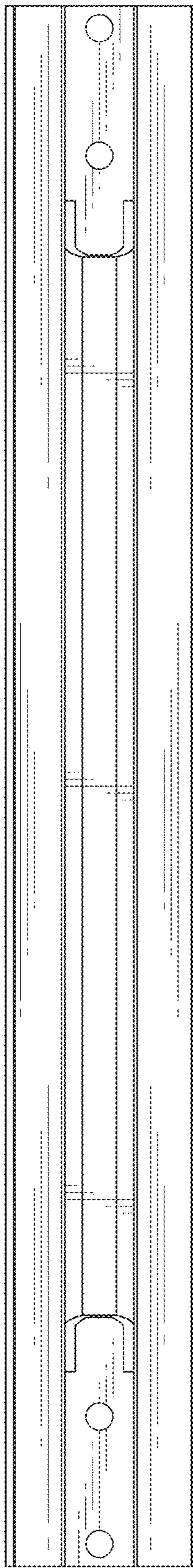

FIG. 6

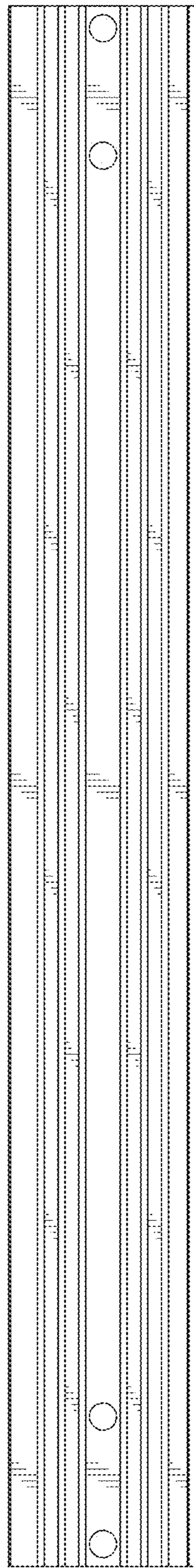

FIG. 7

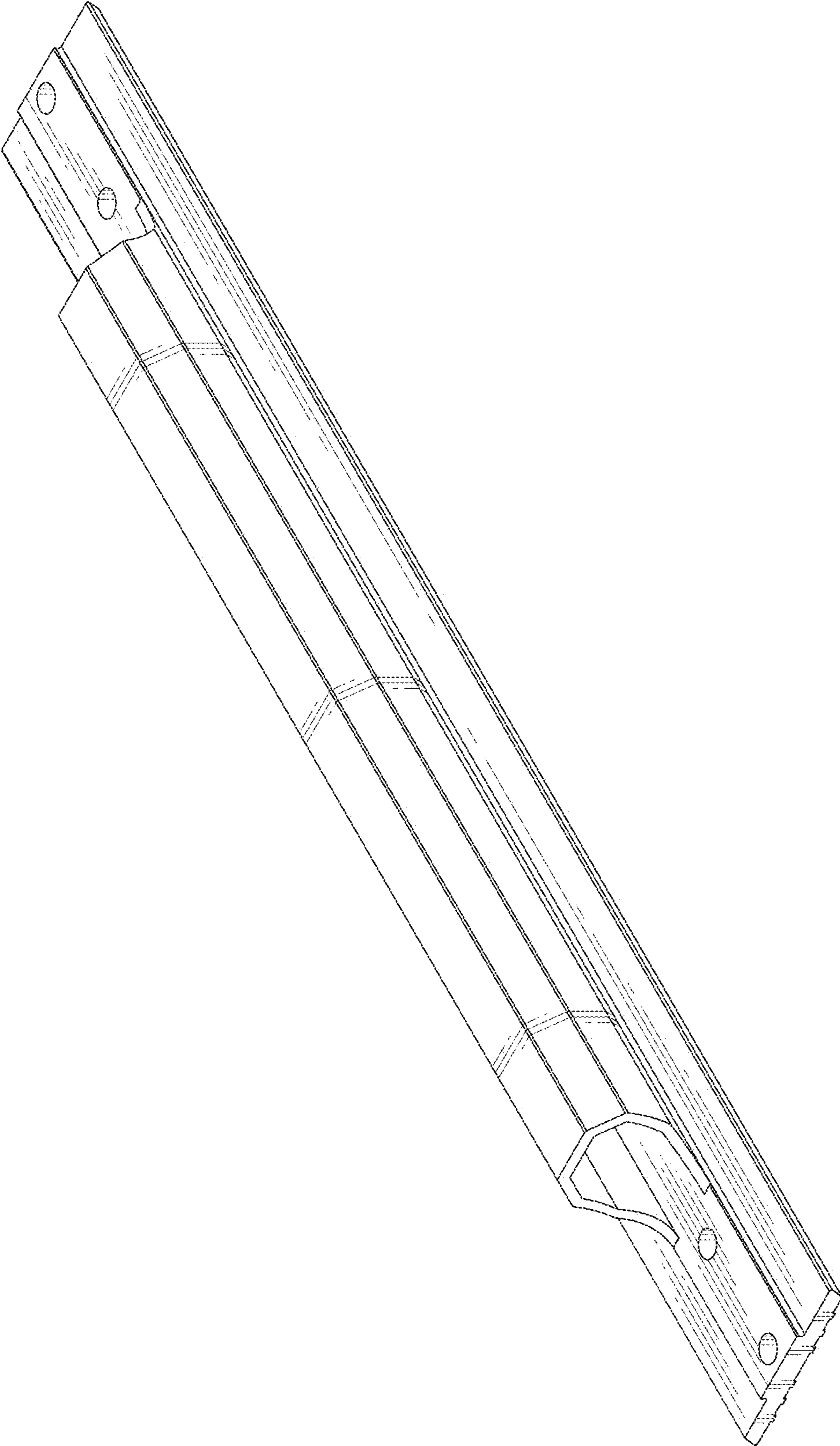

FIG. 8

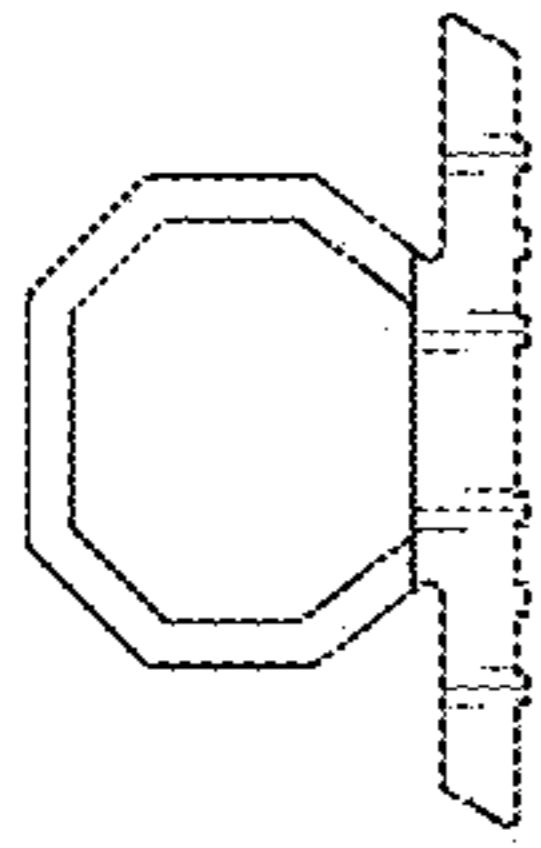

FIG. 9

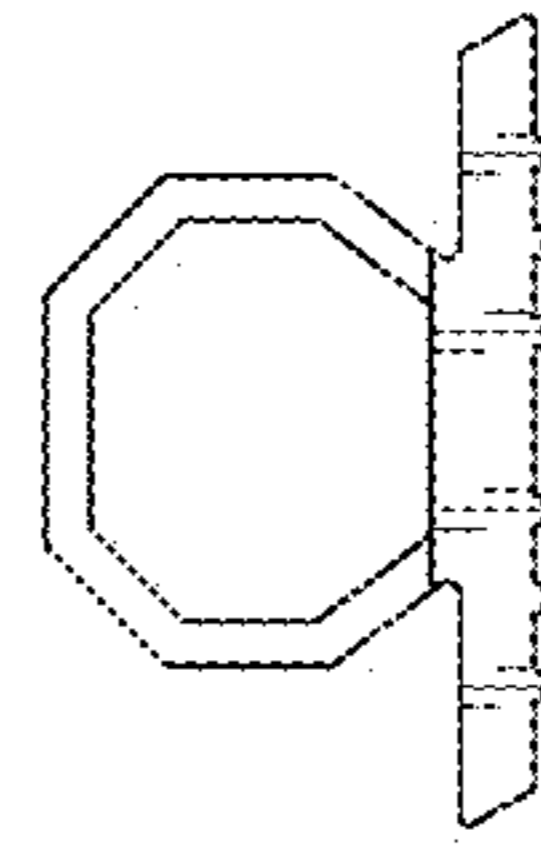

FIG. 10



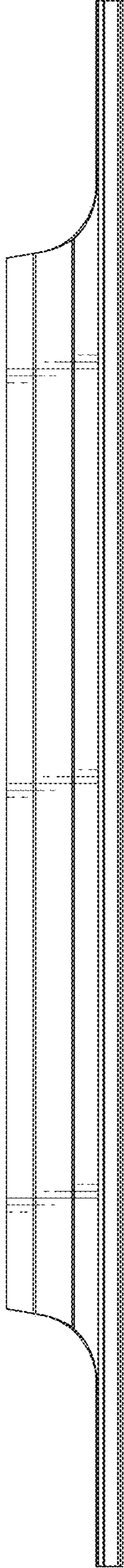

FIG. 11

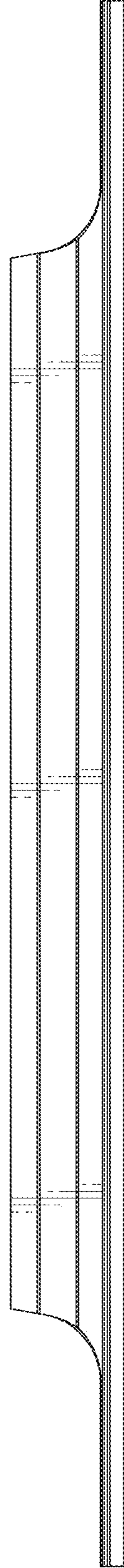

FIG. 12

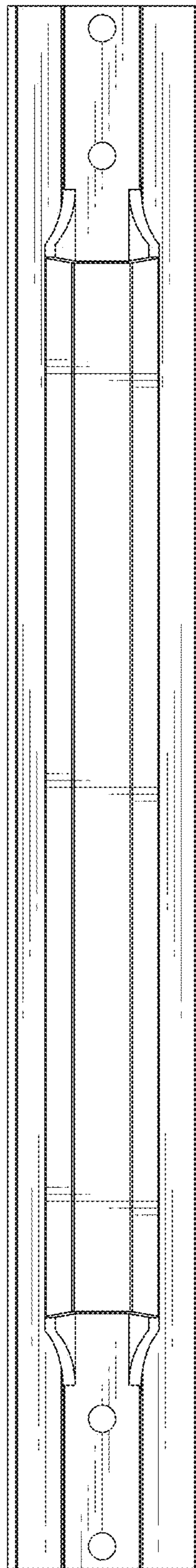

FIG. 13

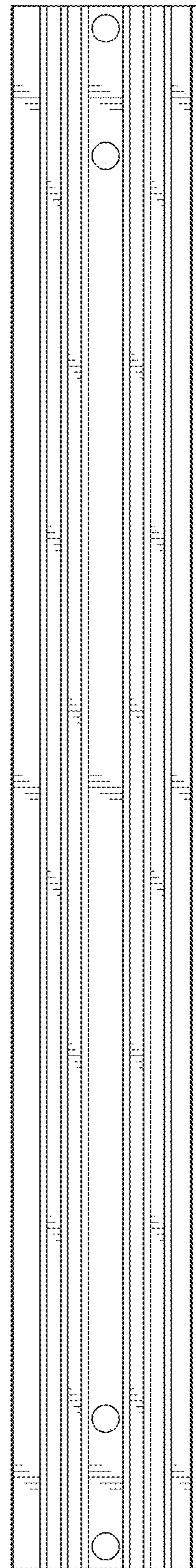

FIG. 14

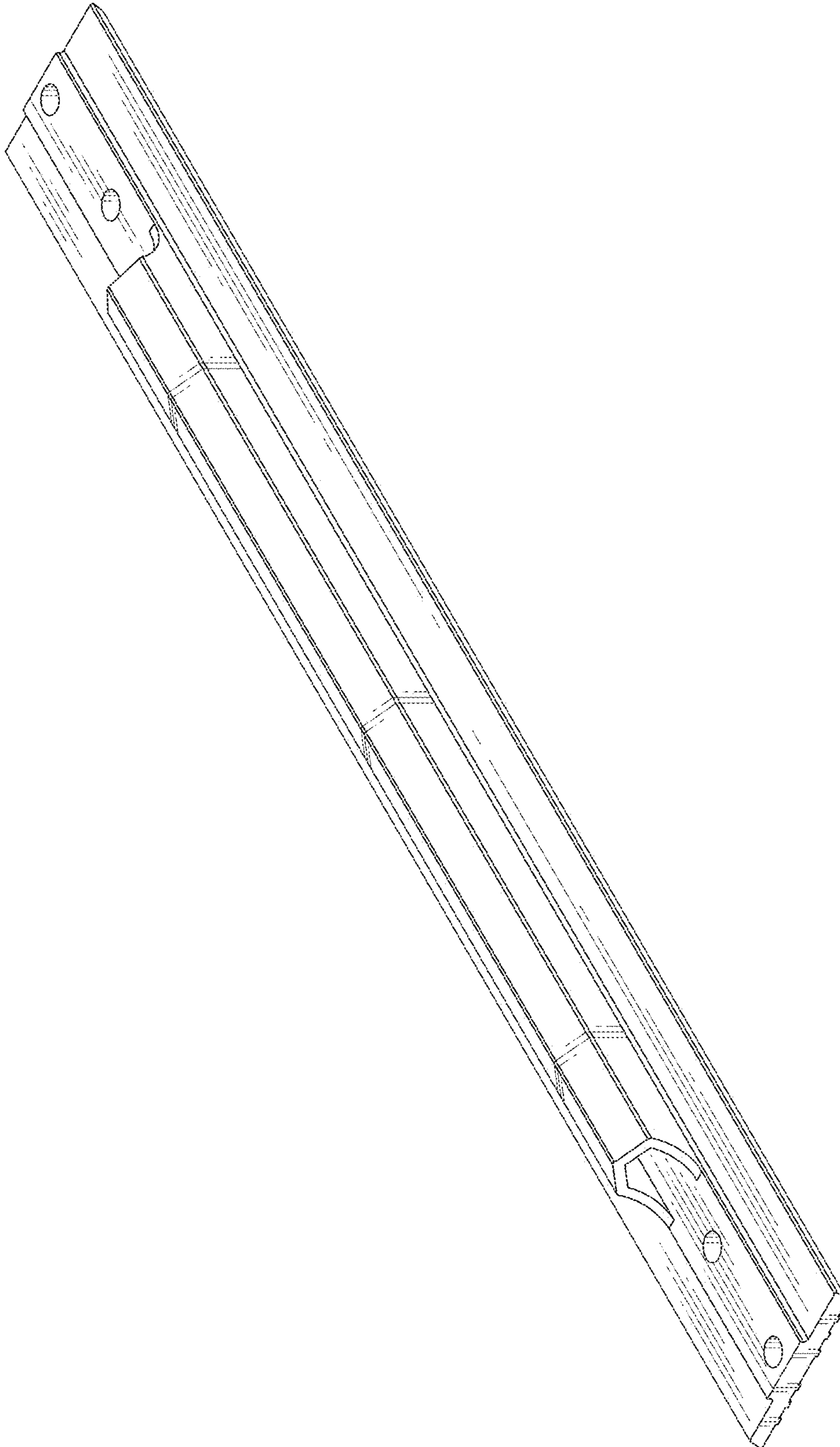

FIG. 15

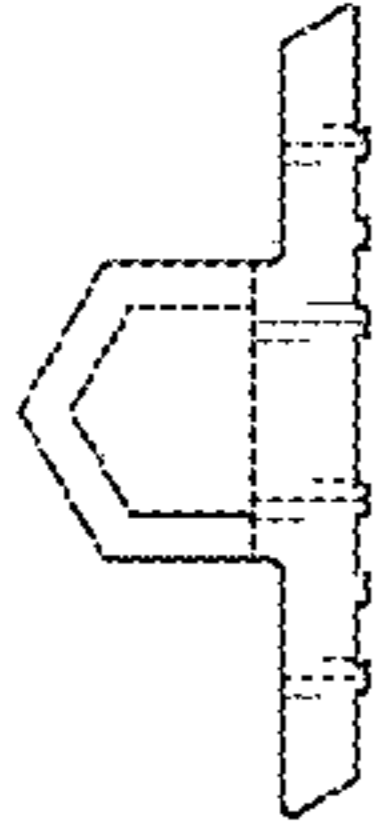

FIG. 16

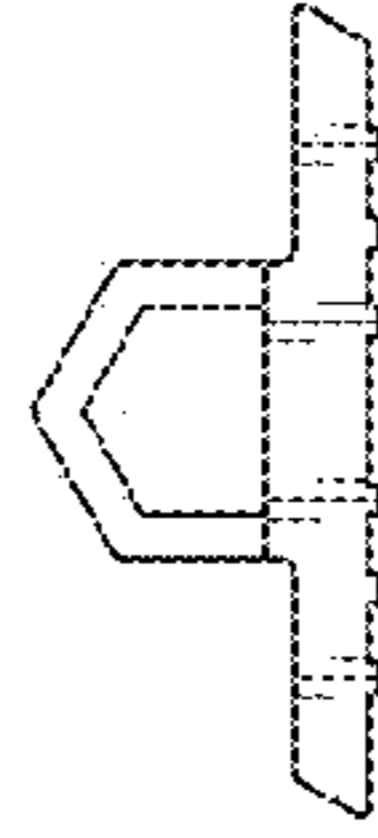

FIG. 17



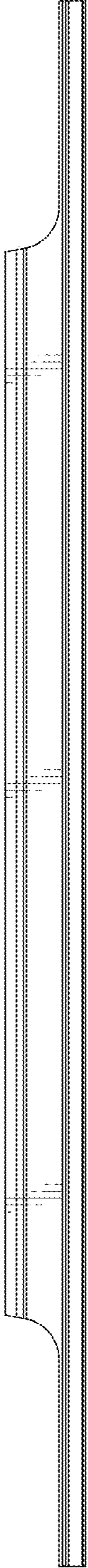

FIG. 18

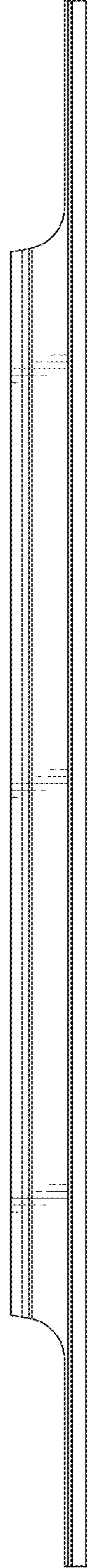

FIG. 19

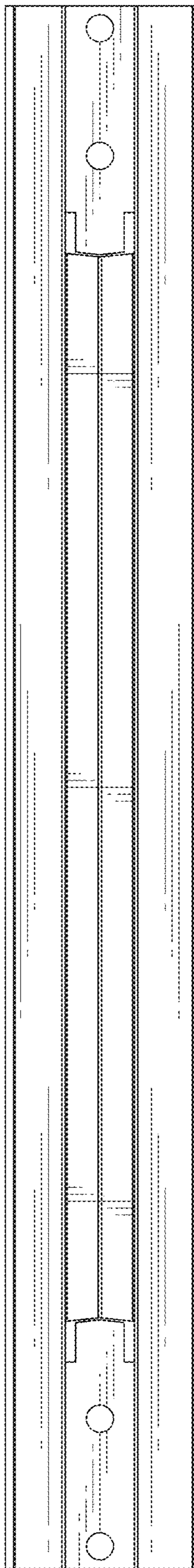

FIG. 20

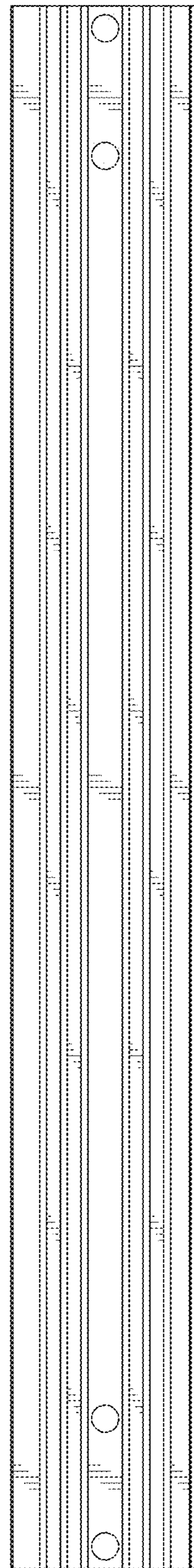

FIG. 21

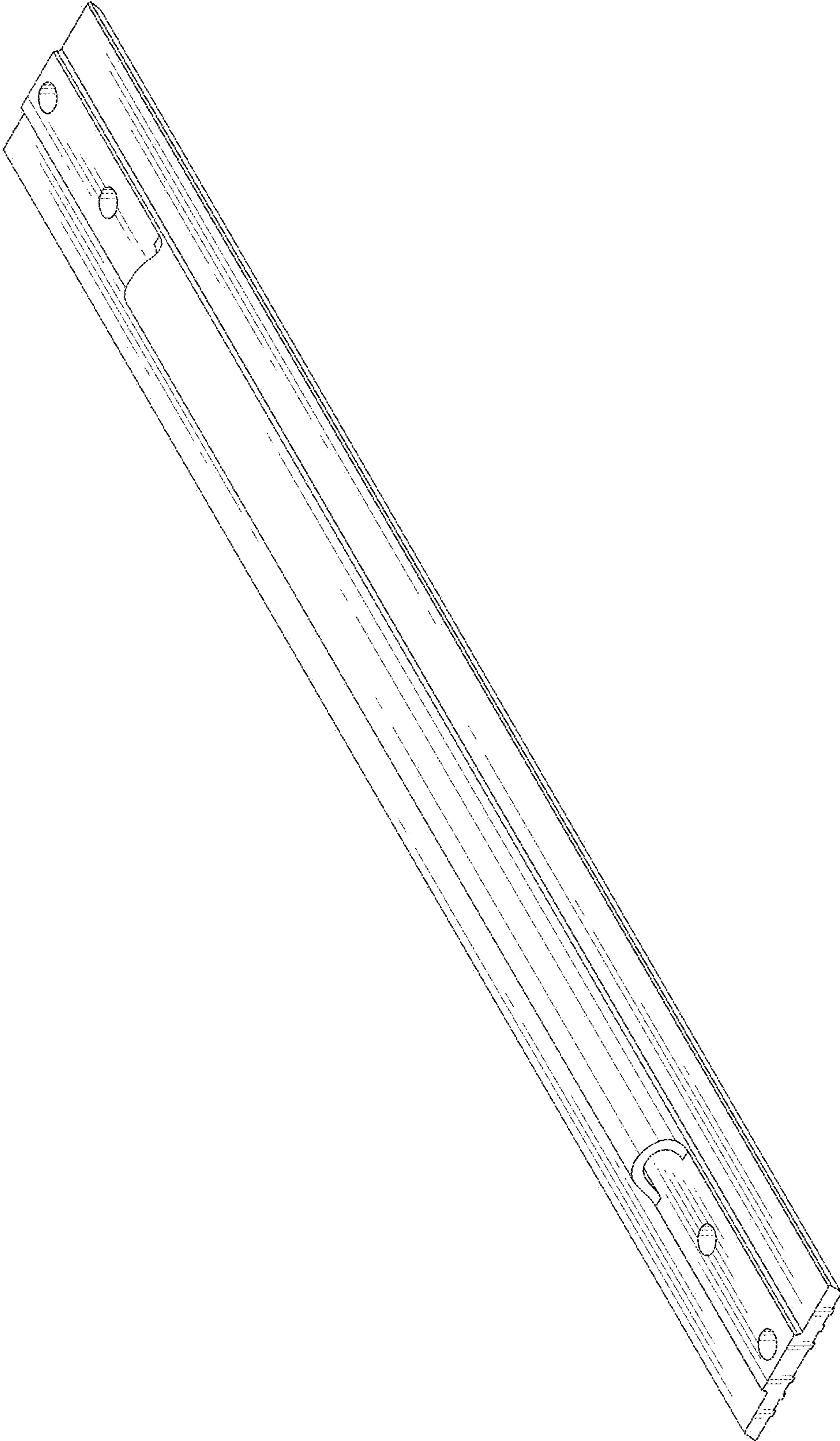

FIG. 22

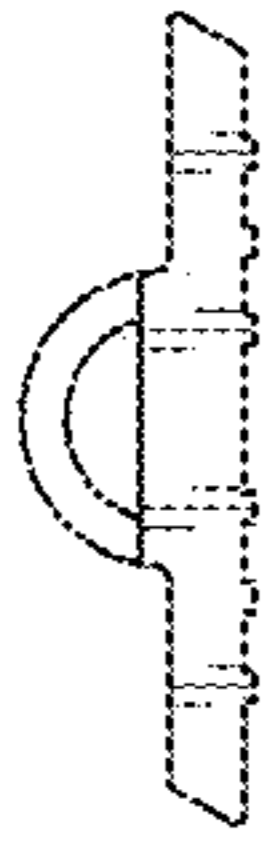

FIG. 23

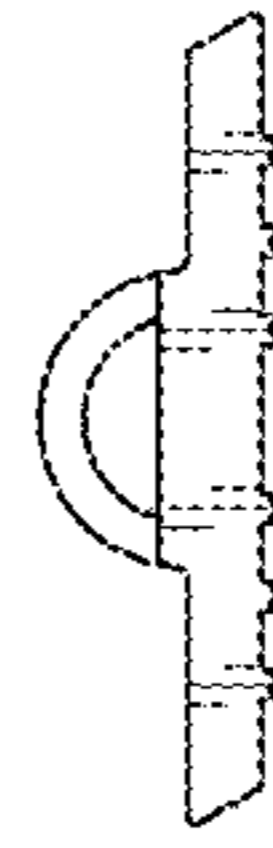

FIG. 24





FIG. 25



FIG. 26

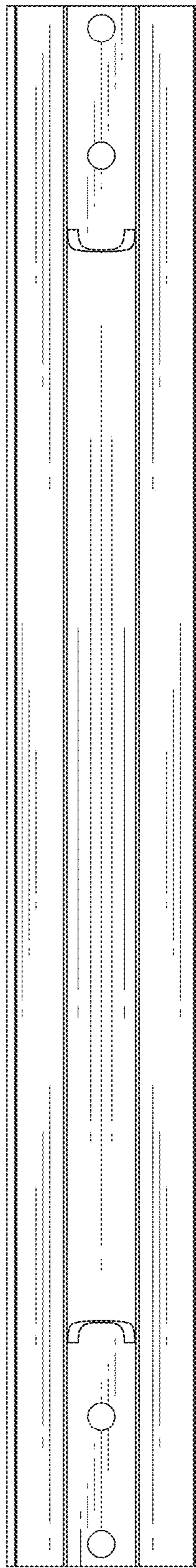

FIG. 27

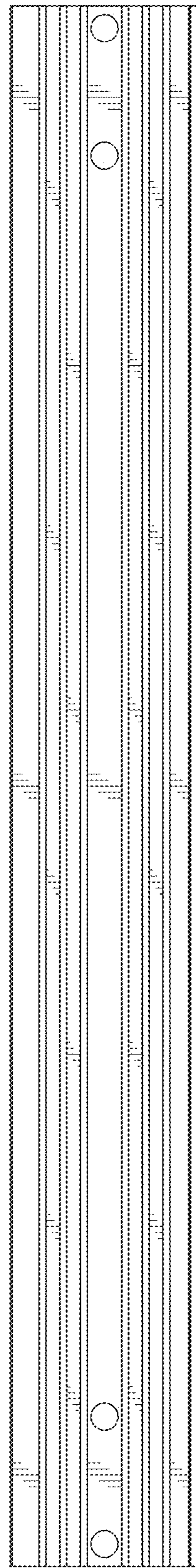

FIG. 28

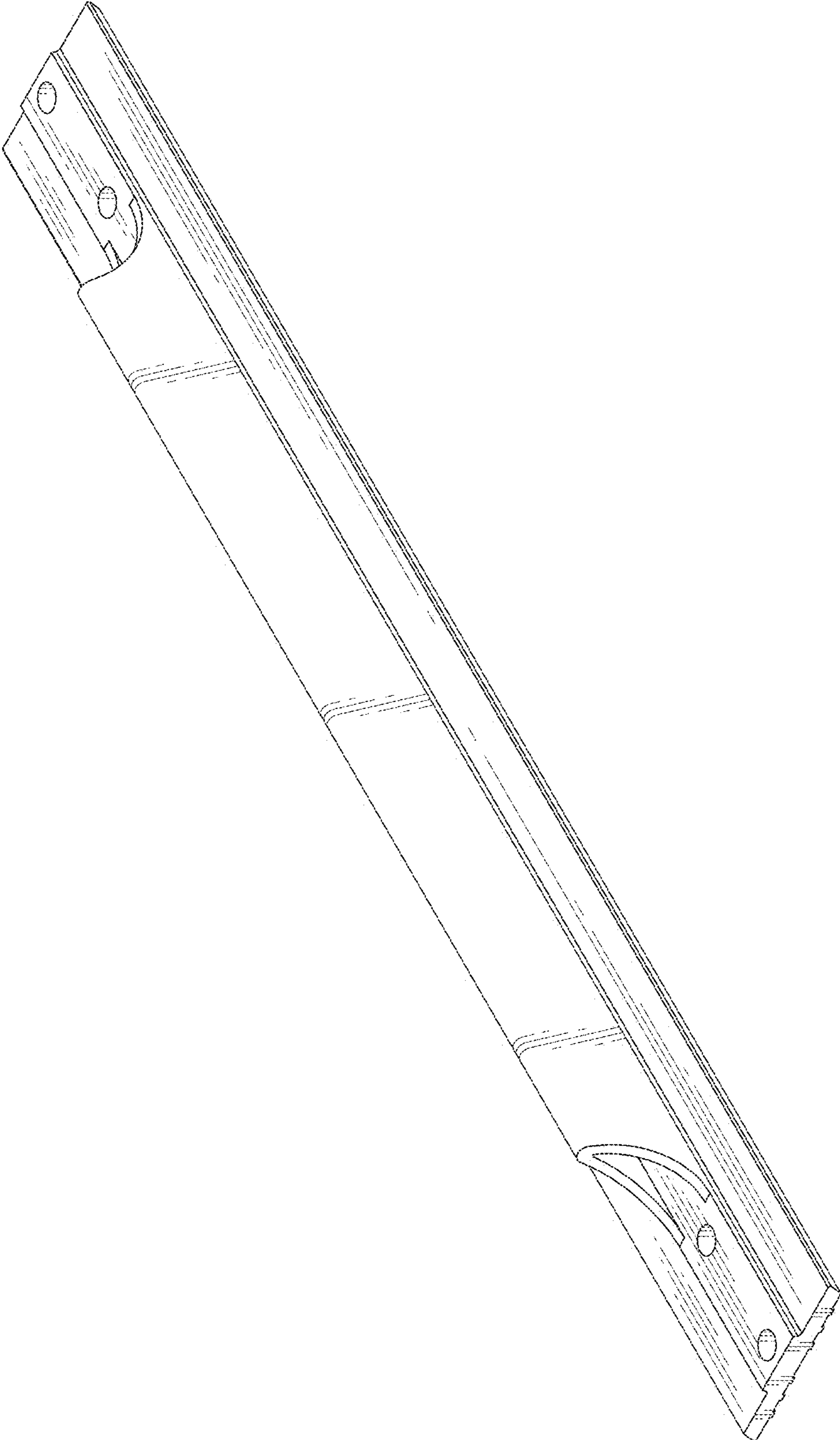

FIG. 29

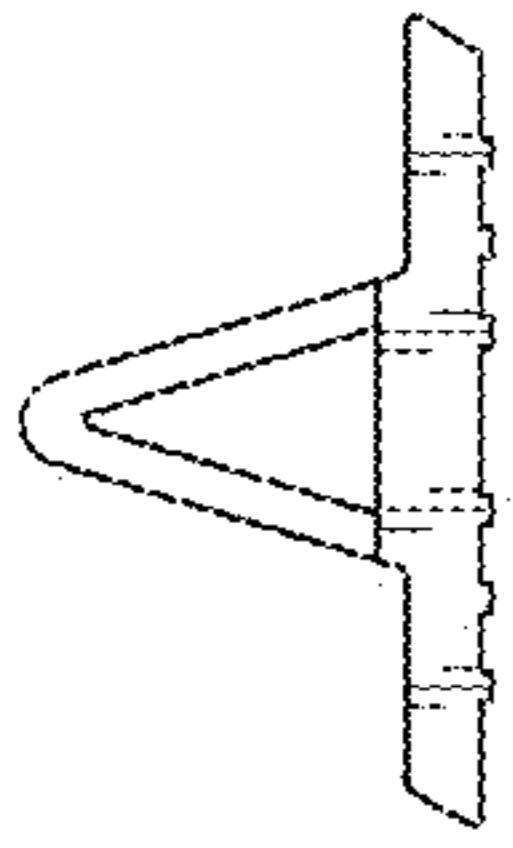

FIG. 30

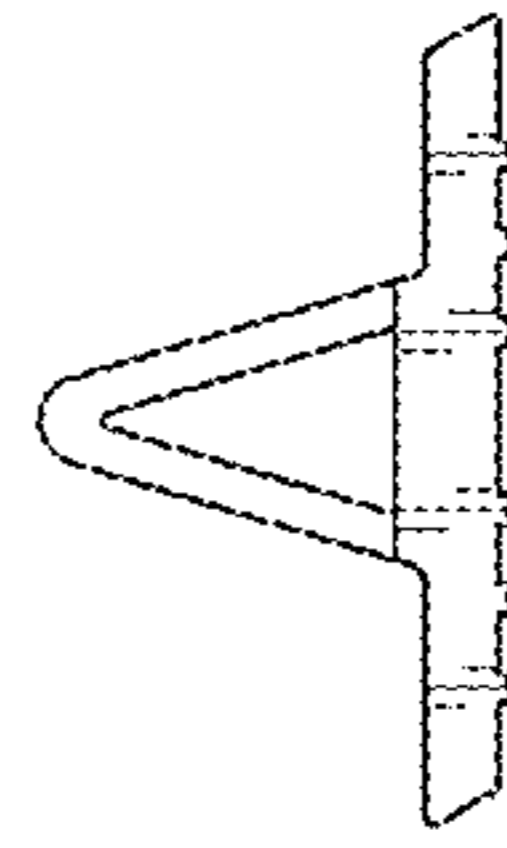

FIG. 31



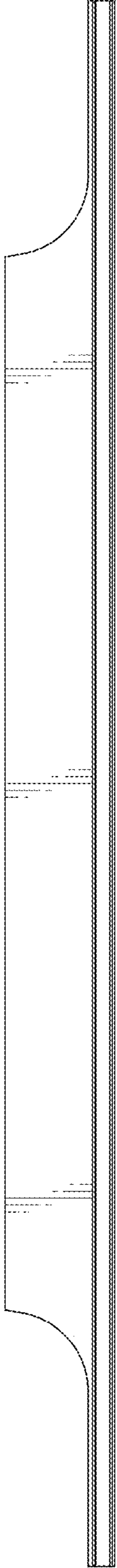

FIG. 32

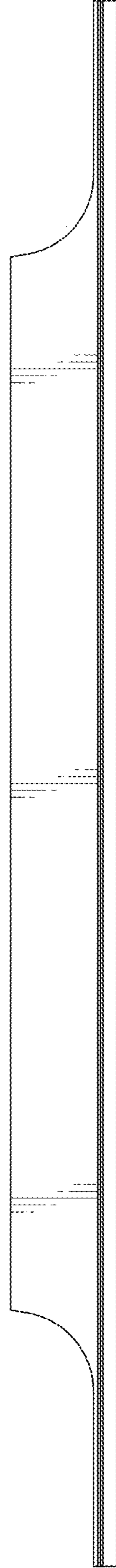

FIG. 33

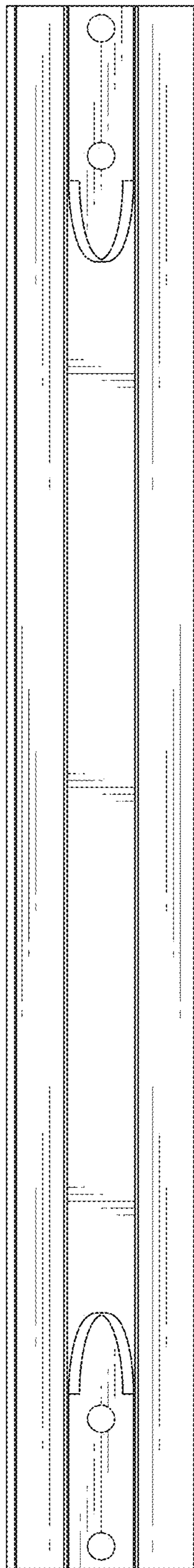

FIG. 34

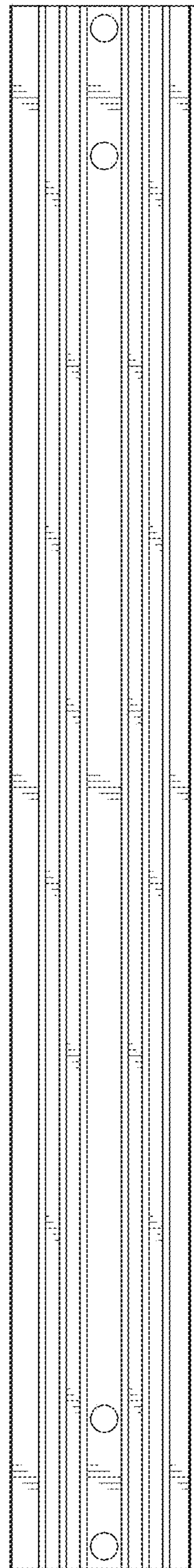

FIG. 35