



US00D969885S

(12) **United States Design Patent**  
**Kim et al.**

(10) **Patent No.:** **US D969,885 S**

(45) **Date of Patent:** **\*\* Nov. 15, 2022**

(54) **REFRIGERATOR**

(71) Applicant: **LG ELECTRONICS INC.**, Seoul (KR)

(72) Inventors: **Minsub Kim**, Seoul (KR); **Kyukwan Choi**, Seoul (KR); **Hangbok Lee**, Seoul (KR); **Yong Kim**, Seoul (KR); **Jihyun Lee**, Seoul (KR); **Yezo Yun**, Seoul (KR)

(73) Assignee: **LG ELECTRONICS INC.**, Seoul (KR)

(\*\*) Term: **15 Years**

(21) Appl. No.: **29/779,343**

(22) Filed: **Apr. 19, 2021**

(30) **Foreign Application Priority Data**

Oct. 29, 2020 (KR) ..... 30-2020-0051957

(51) **LOC (13) Cl.** ..... **15-07**

(52) **U.S. Cl.**  
USPC ..... **D15/85**; D15/81

(58) **Field of Classification Search**  
USPC ..... D15/79-91; D6/661; D8/300, 316, 319, D8/320  
CPC ..... F25D 2323/021; F25D 2323/024; F25D 29/00; F25D 27/005; F25D 29/005; F25D 17/042; F25D 2325/021; F25D 11/00; F25D 11/02; F25D 11/025; F25D 23/00; F25D 23/02; F25D 23/04; F25D 23/12; F25D 23/028; F25D 25/02; F25D 25/021; F25D 25/022; F25D 25/024; F25D 25/025

See application file for complete search history.

(56) **References Cited**

**U.S. PATENT DOCUMENTS**

D607,018 S \* 12/2009 Ai ..... D15/87  
D699,767 S \* 2/2014 Yoon-jung ..... D15/85

D702,266 S \* 4/2014 Mihyun ..... D15/85  
D722,089 S \* 2/2015 Qiang ..... D15/86  
D734,372 S \* 7/2015 Hwang ..... D15/81  
D742,431 S \* 11/2015 Seo ..... D15/86  
D744,551 S \* 12/2015 Park ..... D15/91

(Continued)

**OTHER PUBLICATIONS**

Samsung, RB31 Classic Fridge Freezer with Non Plumbed Water Dispenser, (site visited Feb. 5, 2022), Samsung.com UK website, URL:<<https://www.samsung.com/uk/refrigerators/bottom-mount-freezer/308l-empire-black-rb31fdjndbc-eu/>> (Year: 2022).\*

(Continued)

*Primary Examiner* — Joseph Kukella

*Assistant Examiner* — Mark T. Philipps

(74) *Attorney, Agent, or Firm* — Birch, Stewart, Kolasch & Birch, LLP

(57) **CLAIM**

The ornamental design for a refrigerator, as shown and described.

**DESCRIPTION**

FIG. 1 is a front perspective view of the refrigerator showing our new design;  
FIG. 2 is a front view thereof;  
FIG. 3 is a back view thereof;  
FIG. 4 is a left side view thereof;  
FIG. 5 is a right side view thereof;  
FIG. 6 is a top plan view thereof;  
FIG. 7 is a bottom plan view thereof;  
FIG. 8 is a bottom perspective view thereof; and,  
FIG. 9 is a partial enlarged view of a portion of FIG. 8.  
The broken lines depict portions of the refrigerator that form no part of the claimed design. The long dash-short dash-long dash broken lines in FIGS. 8 and 9 depict the boundary of the enlarged view on FIG. 9, taken from FIG. 8, forming no part of the claimed design.

**1 Claim, 9 Drawing Sheets**

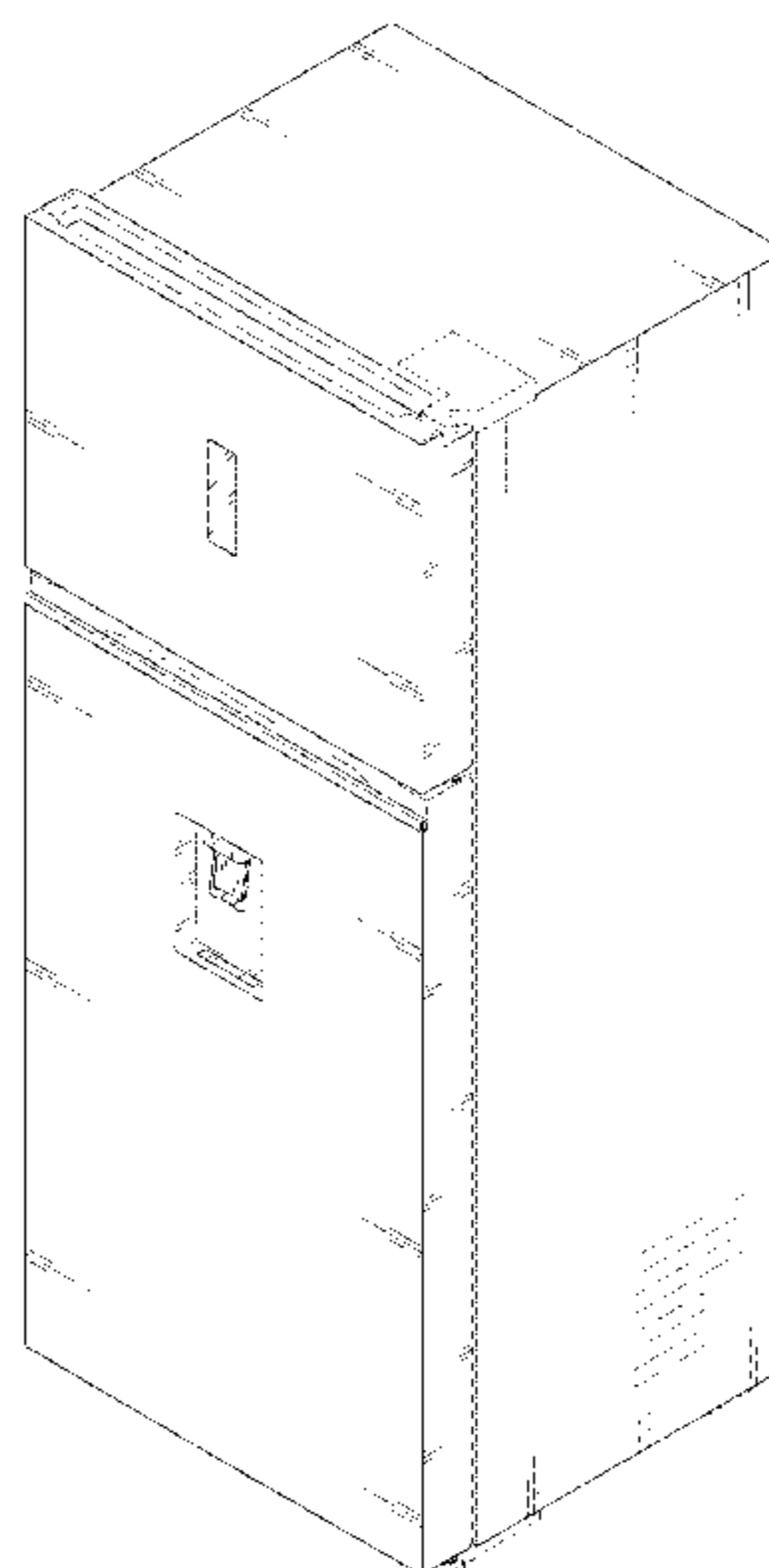

(56)

**References Cited**

U.S. PATENT DOCUMENTS

D789,995 S \* 6/2017 Kim ..... D15/85  
D820,887 S \* 6/2018 Lee ..... D15/88  
D905,130 S \* 12/2020 Yeo ..... F25D 11/02  
D15/86  
D921,062 S \* 6/2021 Lee ..... D15/85  
D921,064 S \* 6/2021 Lee ..... D15/89  
D921,714 S \* 6/2021 Yoon ..... D15/86  
D926,829 S \* 8/2021 Kim ..... F25D 25/025  
D15/85  
D939,597 S \* 12/2021 Xie ..... F25D 25/025  
D15/86

OTHER PUBLICATIONS

Sam Stores, Samsung RT81DTBSP-RT5972DBSP, (site visited Feb. 5, 2022), SamStores.com website, URL:<<https://www.samstores.com/product-samsung-rt81dtbsp-rt5972dbsp-top-mounted-freezer-220-volts-22741.html>> (Year: 2022).\*

LG Electronics, M459P Modern Edge Refrigerator, (site visited Feb. 5, 2020), LG Korean Website, URL:<<https://www.lge.co.kr/refrigerators/m459p>> (Year: 2022).\*

\* cited by examiner

FIG. 1

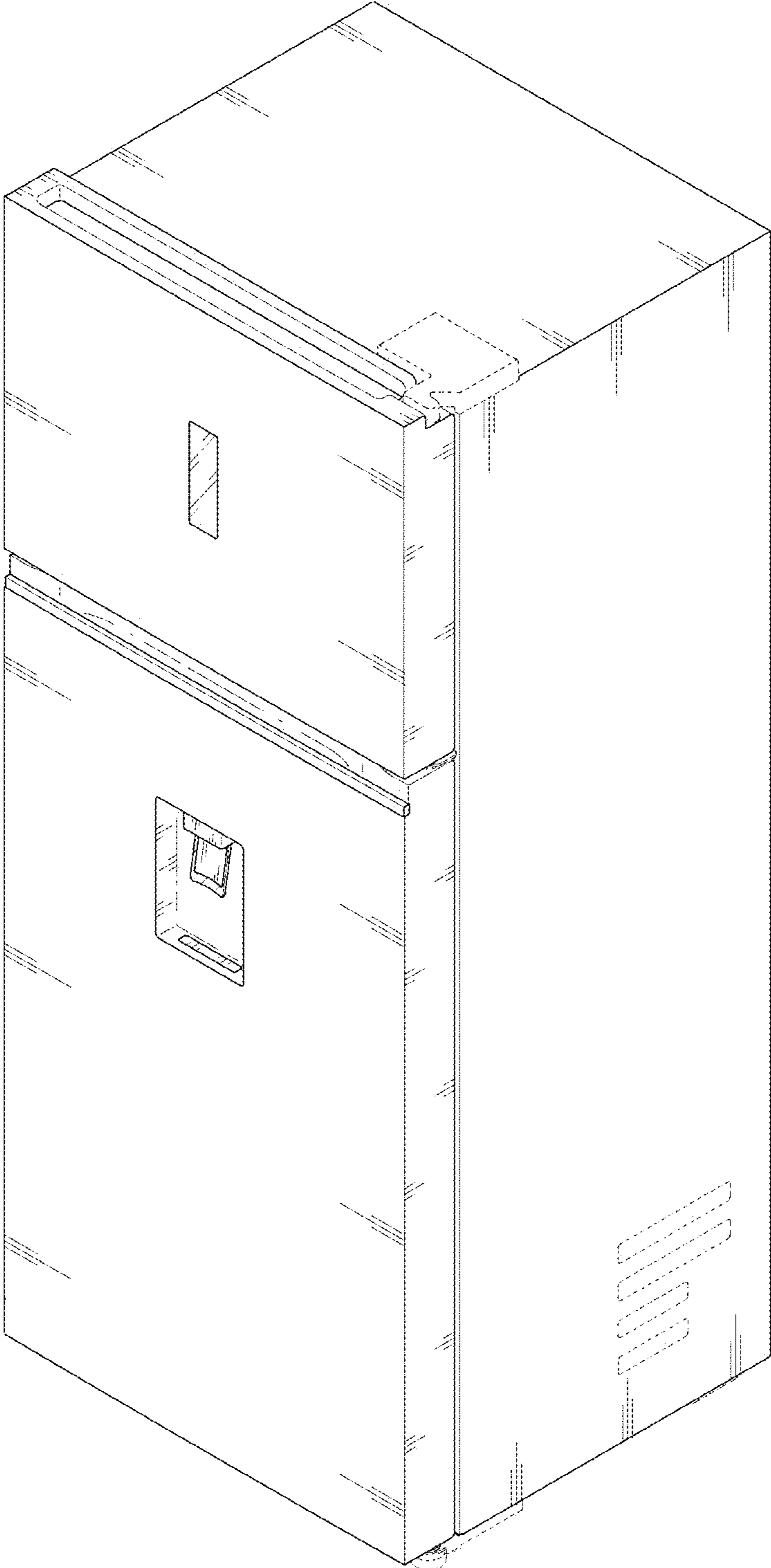

FIG. 2

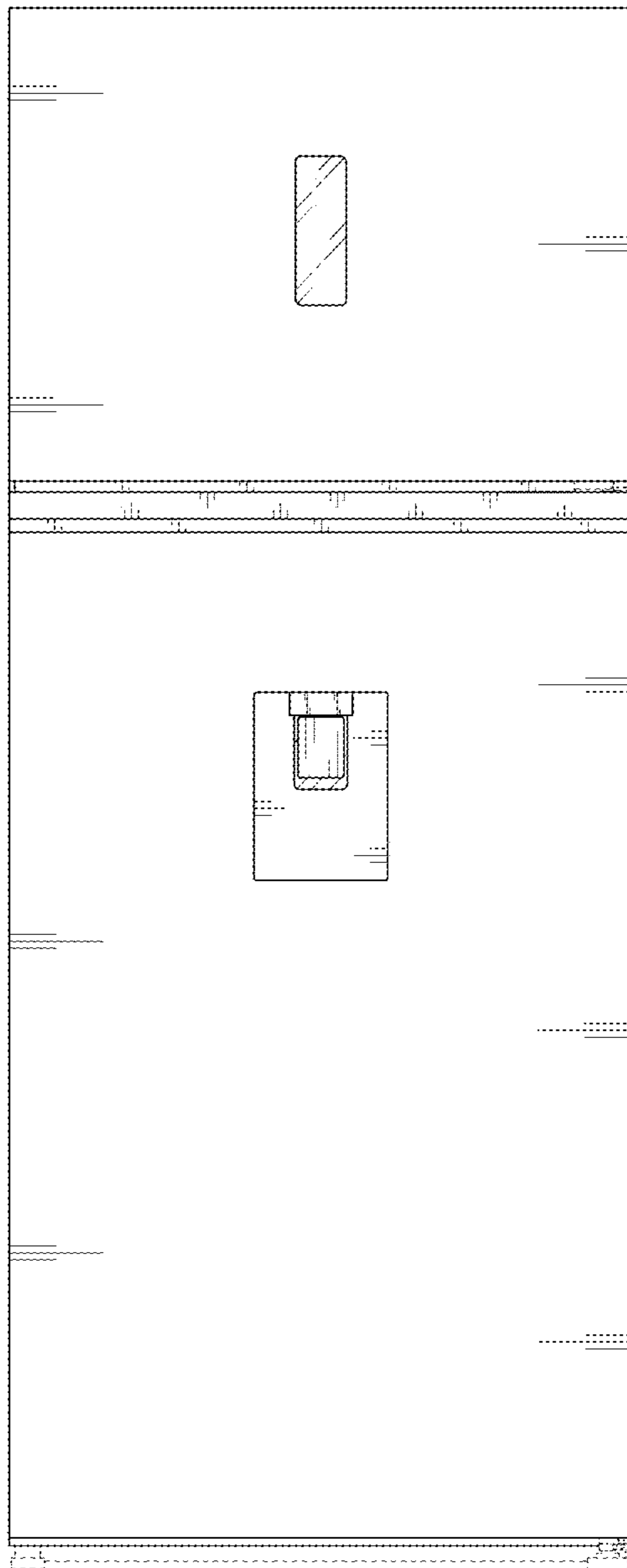

FIG. 3

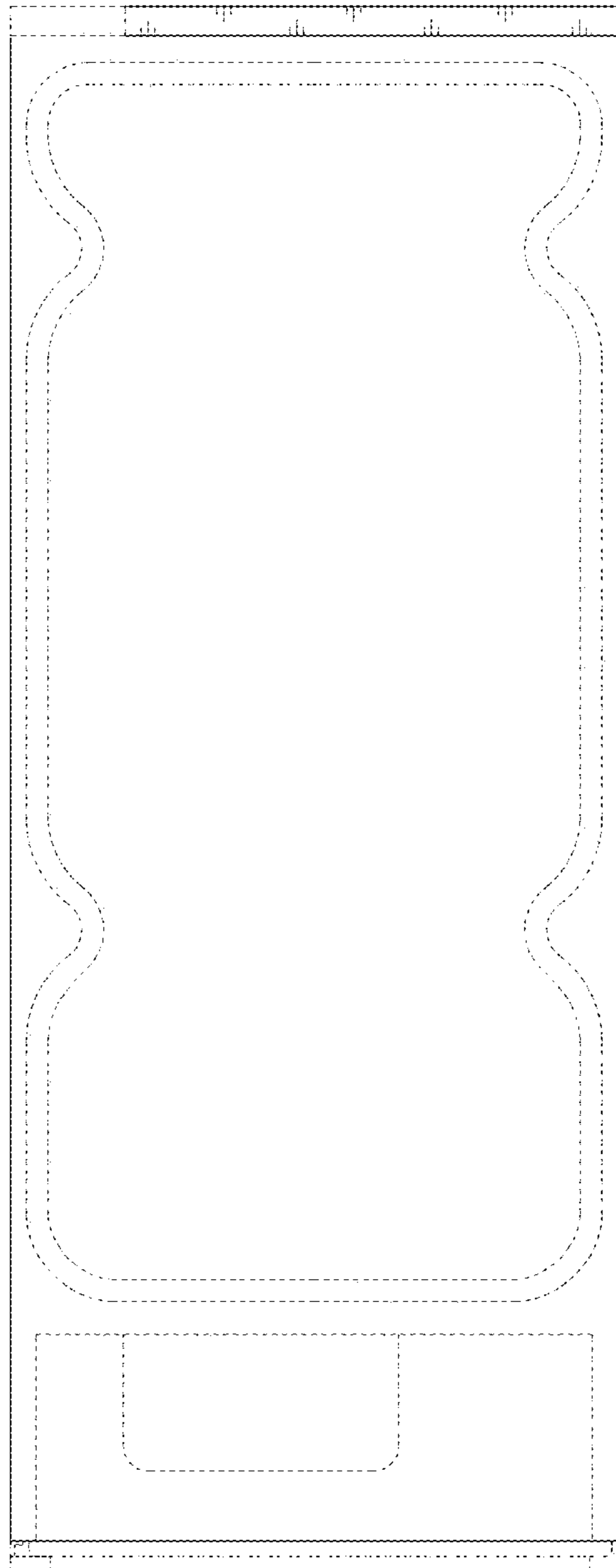

FIG. 4

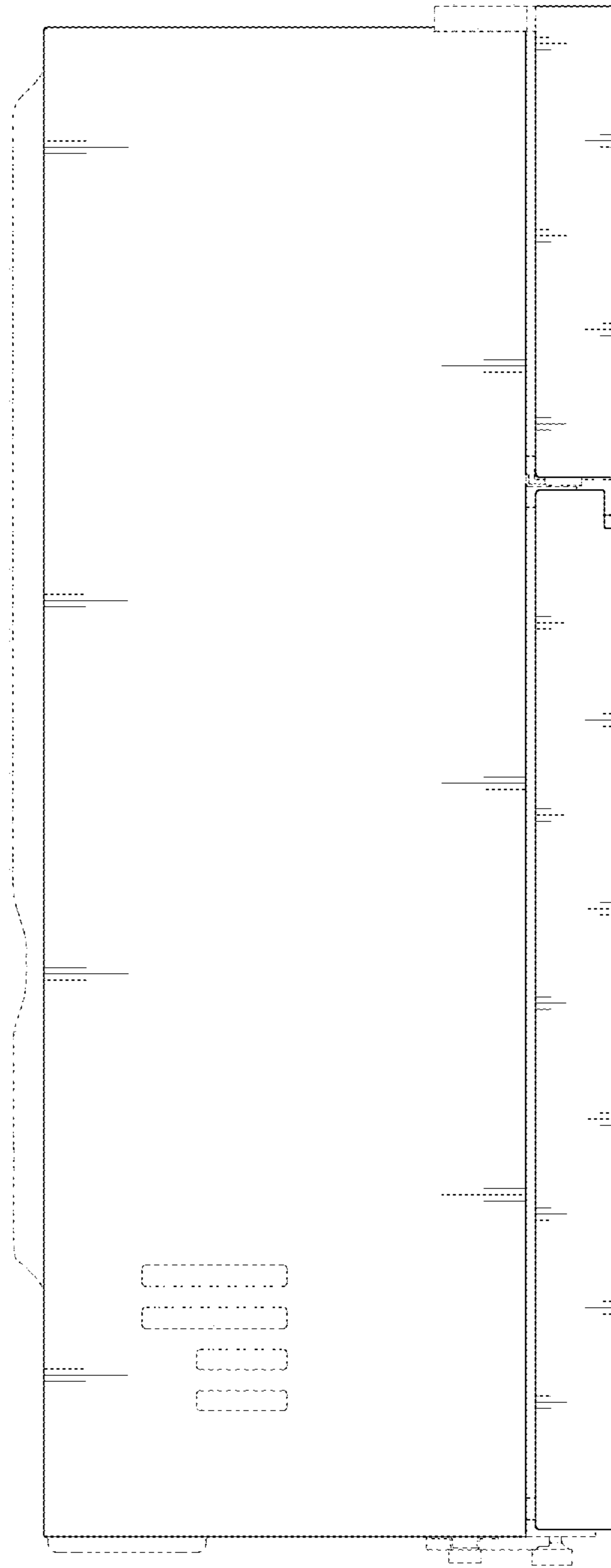

FIG. 5

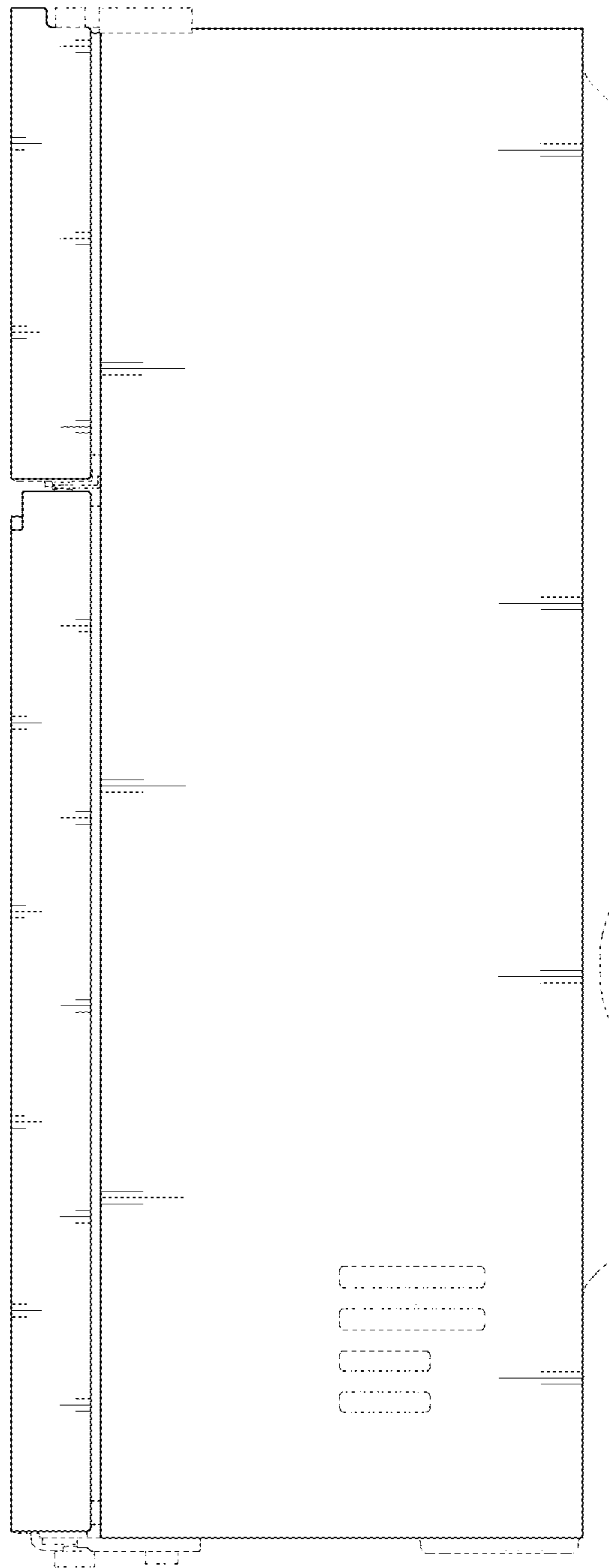

FIG. 6

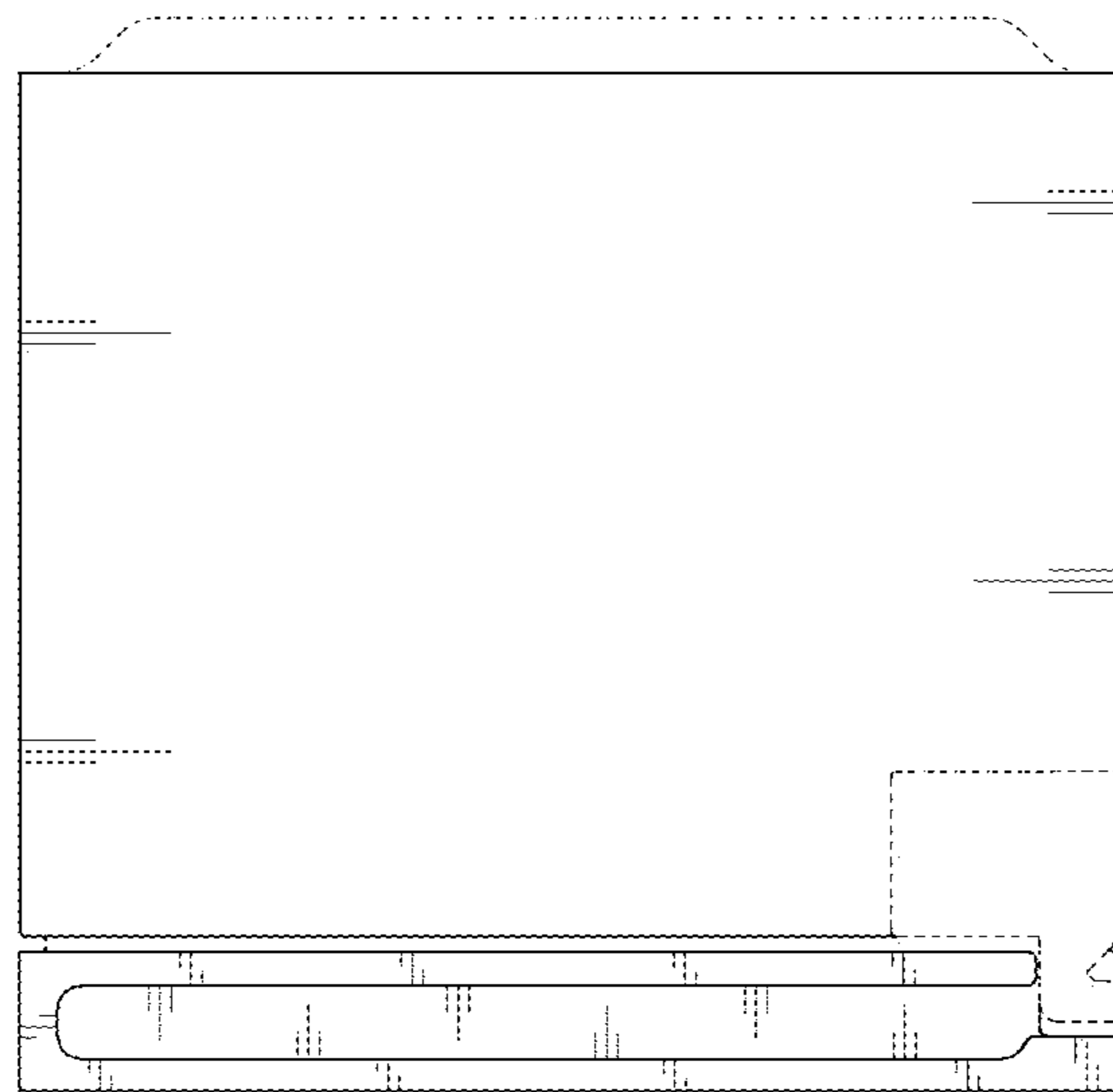



FIG. 7

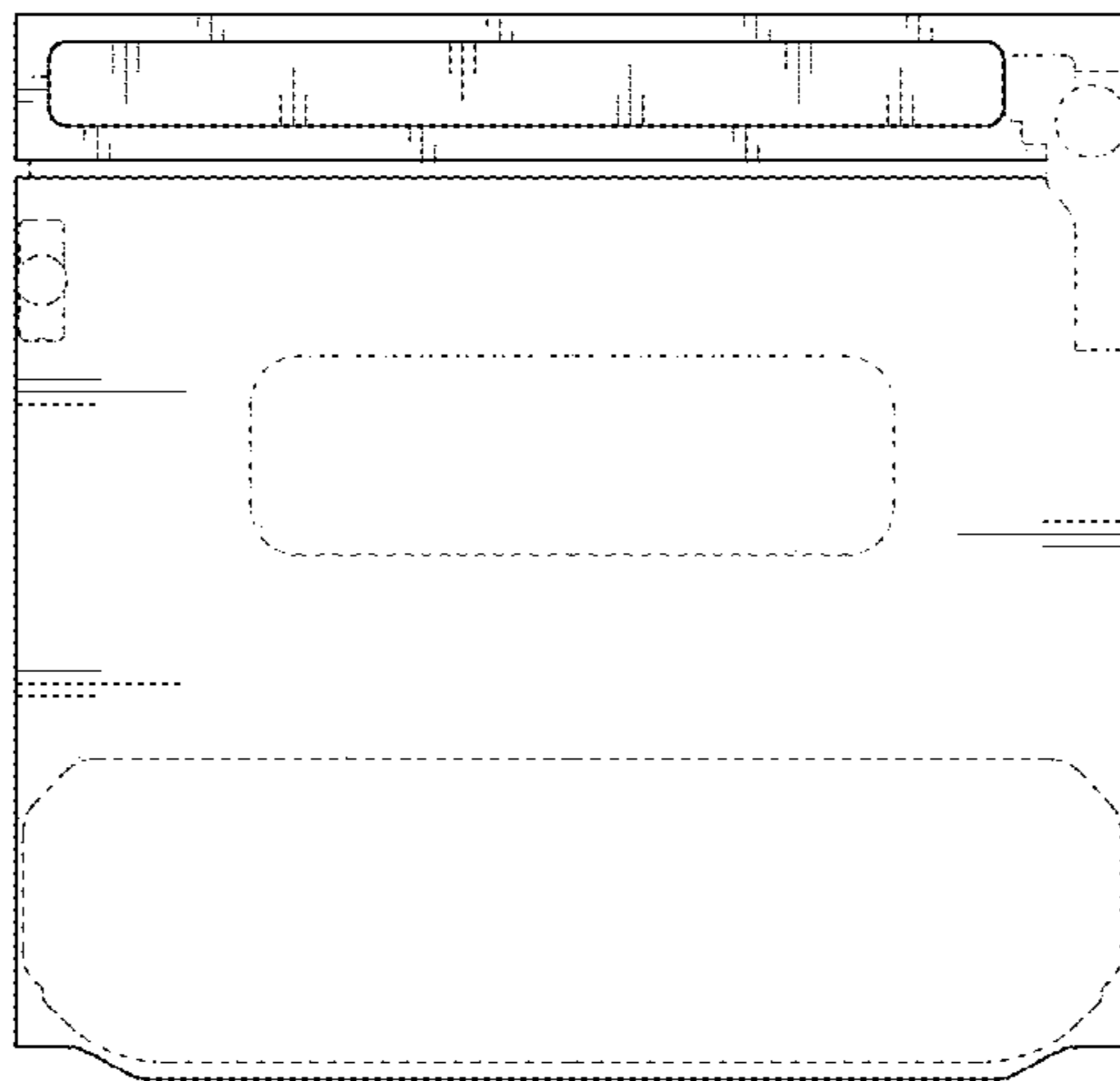

FIG. 8

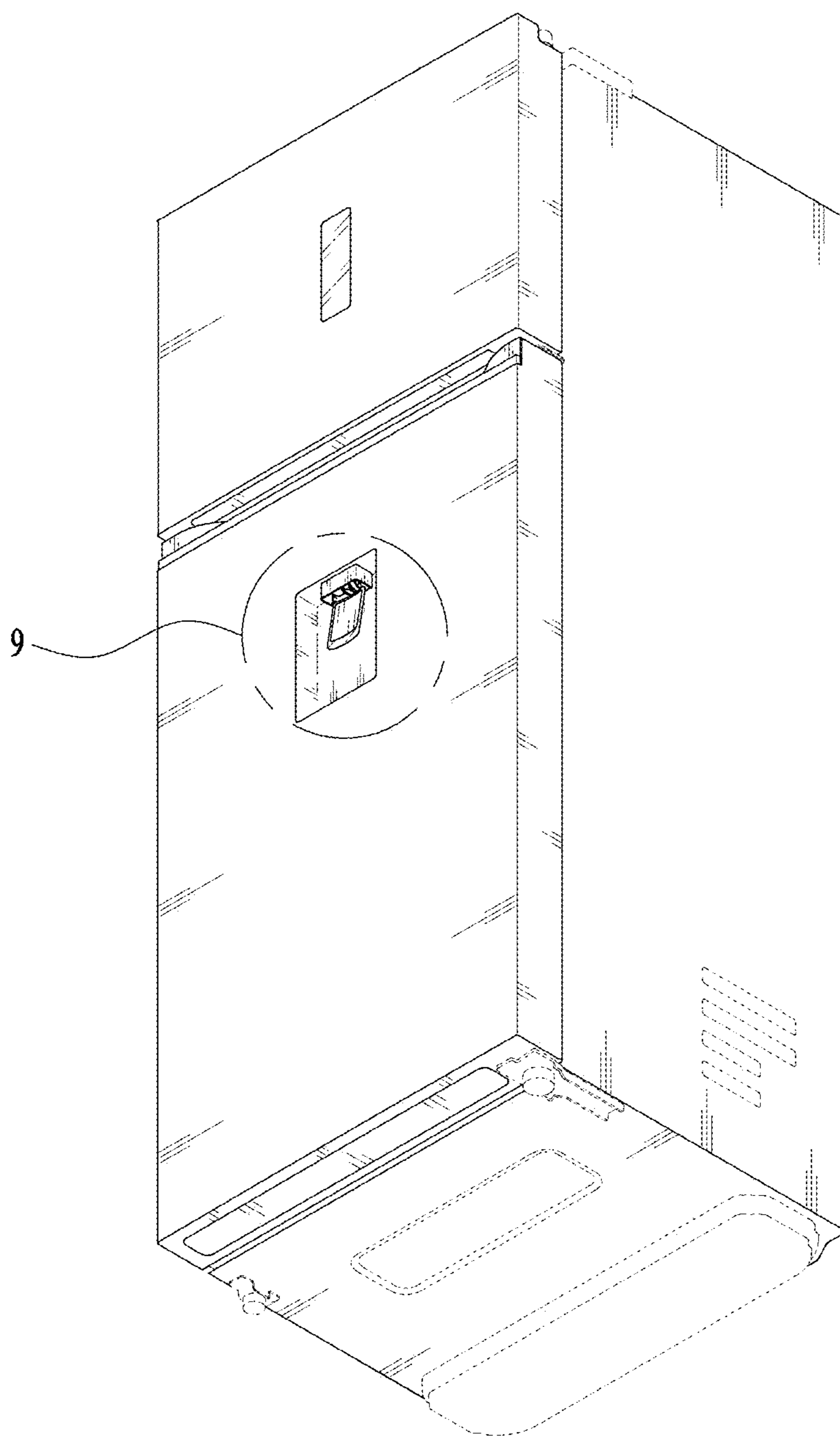

FIG. 9

