



US00D969814S

(12) **United States Design Patent**  
**Zhu**

(10) **Patent No.:** **US D969,814 S**

(45) **Date of Patent:** **\*\* Nov. 15, 2022**

(54) **KEYBOARD WITH ROTATABLE MOUNT**

(71) Applicant: **Dawen Zhu**, DongGuan (CN)

(72) Inventor: **Dawen Zhu**, DongGuan (CN)

(\*\*) Term: **15 Years**

(21) Appl. No.: **29/711,809**

(22) Filed: **Nov. 3, 2019**

(51) **LOC (13) Cl.** ..... **14-02**

(52) **U.S. Cl.**

USPC ..... **D14/440**; D14/320; D14/392

(58) **Field of Classification Search**

USPC ..... D14/315–327, 331, 333, 334, 335,  
D14/338–340, 388, 390, 391, 392, 394,  
D14/396, 399, 432, 433, 439, 440, 443,  
D14/447, 450, 451, 454, 455, 471, 356,  
D14/397, 398, 434; D18/1, 4.3, 4.5, 7,  
D18/11, 12, 12.2, 12.3

CPC ..... G06F 1/16; G06F 1/1601; G06F 1/1605;  
G06F 1/1607; G06F 1/1613; G06F  
1/1616; G06F 1/1618; G06F 1/162; G06F  
1/1622; G06F 1/1624; G06F 1/1626;  
G06F 1/1628; G06F 16/1633; G06F  
1/1637; G06F 1/1641; G06F 1/1643;  
G06F 1/1647; G06F 1/1649; G06F 1/165;  
G06F 1/1652; G06F 1/1654; G06F  
1/1656; G06F 1/1662; G06F 1/1664;  
G06F 1/1666; G06F 1/1667; G06F  
1/1669; G06F 1/1671; G06F 1/1675;  
G06F 1/1681; G06F 1/1686; G06F  
1/1688; G06F 1/169; G06F 1/1692; G06F  
1/181; H05K 5/0017; H05K 5/03; H05K  
5/0052; H05K 5/0069; H05K 5/0217;  
H05K 5/0239; H05K 5/0249; H05K  
5/0247; H05K 5/003; H04B 1/3888;  
H04M 1/021; H04M 1/0212

See application file for complete search history.

(56) **References Cited**

**U.S. PATENT DOCUMENTS**

7,286,341 B1 \* 10/2007 Chang ..... G06F 1/1683  
361/679.09

D675,625 S \* 2/2013 Hasbrook ..... D14/440

(Continued)

**OTHER PUBLICATIONS**

Lenrich Ipad Pro 11 inch case. Lenrich, amazon.com (online) 13 pages. Posted Dec. 6, 2020. [Retrieved Apr. 26, 2022] [https://www.amazon.com/dp/B0786H6QS7/ref=cm\\_sw\\_em\\_r\\_mt\\_dp\\_A2XAH4WYQPSRP0SRPM68](https://www.amazon.com/dp/B0786H6QS7/ref=cm_sw_em_r_mt_dp_A2XAH4WYQPSRP0SRPM68) (Year: 2020).\*

(Continued)

*Primary Examiner* — Kathleen L Jones

*Assistant Examiner* — Cole Sanders Holman

(57) **CLAIM**

The ornamental design for a keyboard with rotatable mount, as shown and described.

**DESCRIPTION**

FIG. 1 is a front perspective view of a keyboard with rotatable mount showing my new design; FIG. 2 is a rear perspective view thereof; FIG. 3 is a front elevational view thereof; FIG. 4 is a rear elevational view thereof; FIG. 5 is a left side elevational view thereof; FIG. 6 is a right side elevational view thereof; FIG. 7 is a top plan view thereof; FIG. 8 is a bottom plan view thereof; FIG. 9 is an exploded front perspective view thereof, exposing the tablet mount of the keyboard with rotatable mount for clarity of illustration and showing the keyboard with rotatable mount in an alternate position with the kickstand extended. FIG. 10 is an exploded rear perspective view thereof; and, FIG. 11 is a front perspective view thereof, showing the tablet mount in a rotated position. The dashed broken lines in the figures depict portions of the keyboard with rotatable mount that form no part of the claimed design.

**1 Claim, 11 Drawing Sheets**

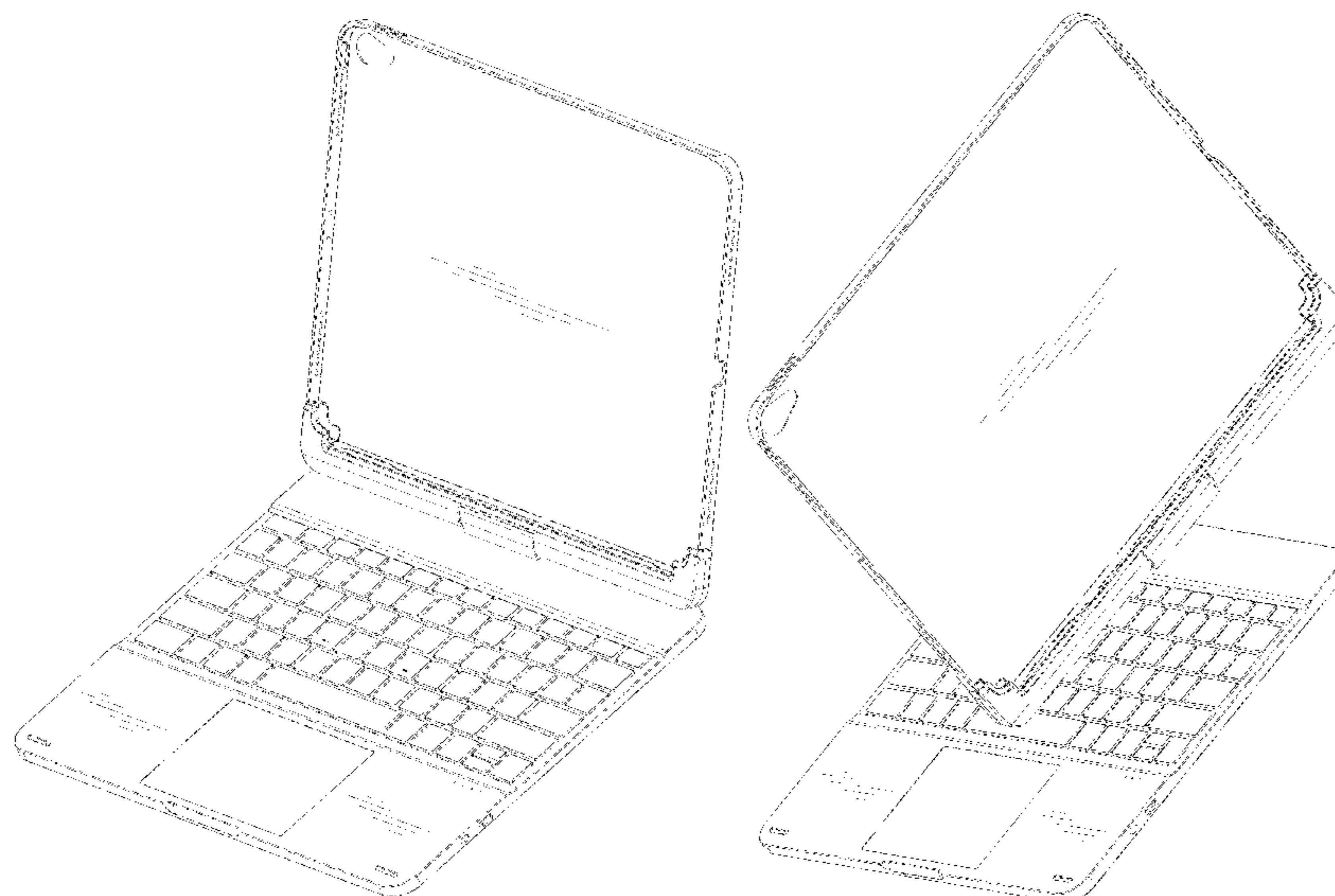

(56)

**References Cited**

U.S. PATENT DOCUMENTS

D748,619	S *	2/2016	Hsu .....	D14/316
D772,880	S *	11/2016	Corcoran .....	D14/440
D822,674	S *	7/2018	Zhu .....	D14/455
D832,854	S *	11/2018	Jinkinson .....	D14/440
D845,947	S *	4/2019	Raken .....	D14/341
D890,184	S *	7/2020	Zhu .....	D14/440
D892,127	S *	8/2020	Chen .....	D14/440
D905,697	S *	12/2020	Chen .....	D14/440
D918,214	S *	5/2021	Chen .....	D14/440
D940,145	S *	1/2022	Zhang .....	D14/440
2011/0110670	A1 *	5/2011	Atkinson .....	G06F 1/1681 361/679.21
2012/0218699	A1 *	8/2012	Leung .....	G06F 1/1656 361/810
2016/0134322	A1 *	5/2016	Lee .....	H04M 1/04 455/575.3
2019/0212784	A1 *	7/2019	Oakeson .....	G06F 1/1669
2020/0004301	A1 *	1/2020	Cai .....	G06F 3/017

OTHER PUBLICATIONS

Typecase flexbook. Typecase, amazon.com (online) 12 pages. Posted Mar. 12, 2020. [Retrieved Apr. 26, 2022] [https://www.amazon.com/dp/B085QJ4GP5/ref=cm\\_sw\\_em\\_r\\_mt\\_dp\\_0G0EMH37GF6C3M292ZBE](https://www.amazon.com/dp/B085QJ4GP5/ref=cm_sw_em_r_mt_dp_0G0EMH37GF6C3M292ZBE) (Year: 2020).\*

\* cited by examiner

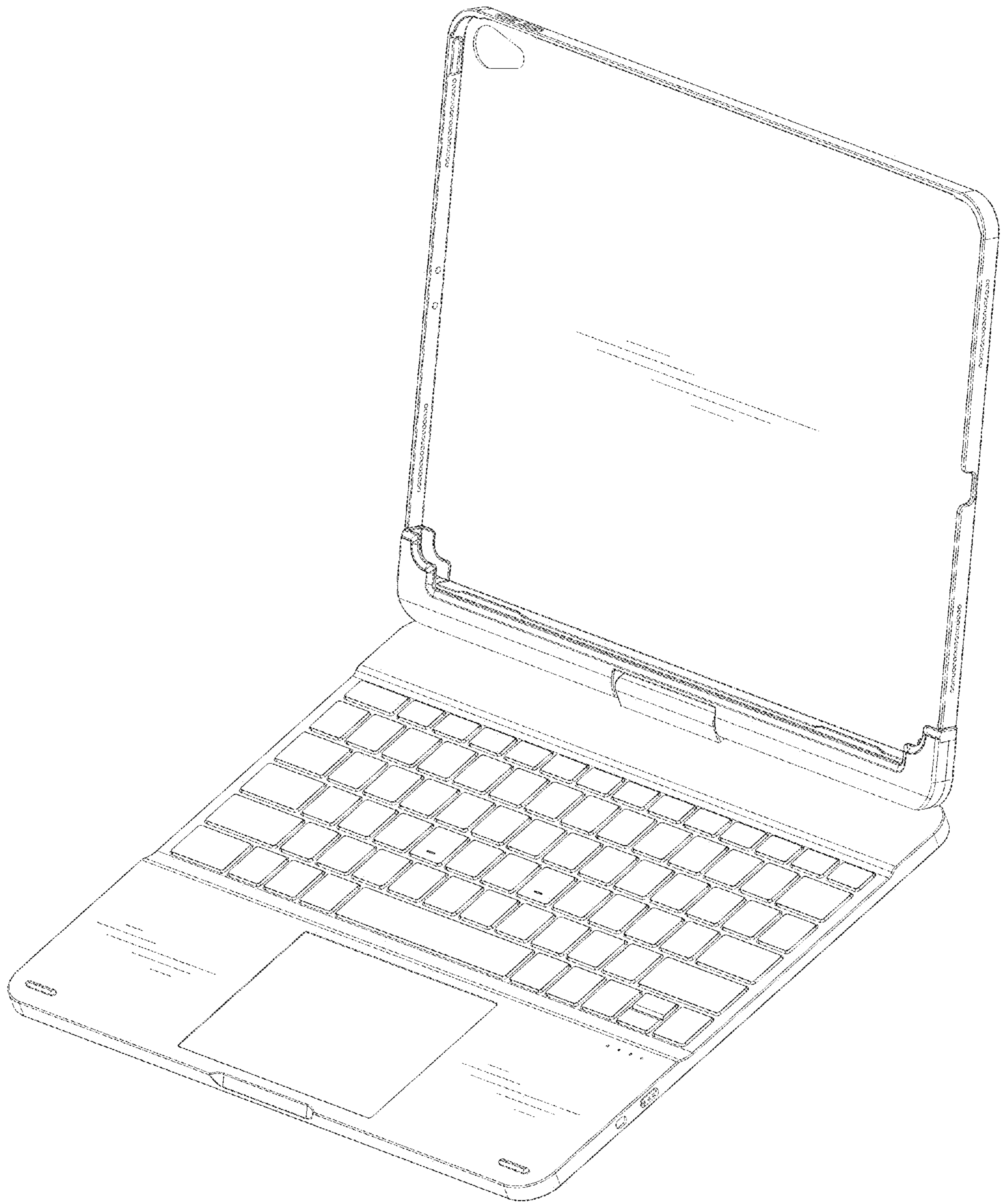

FIG. 1

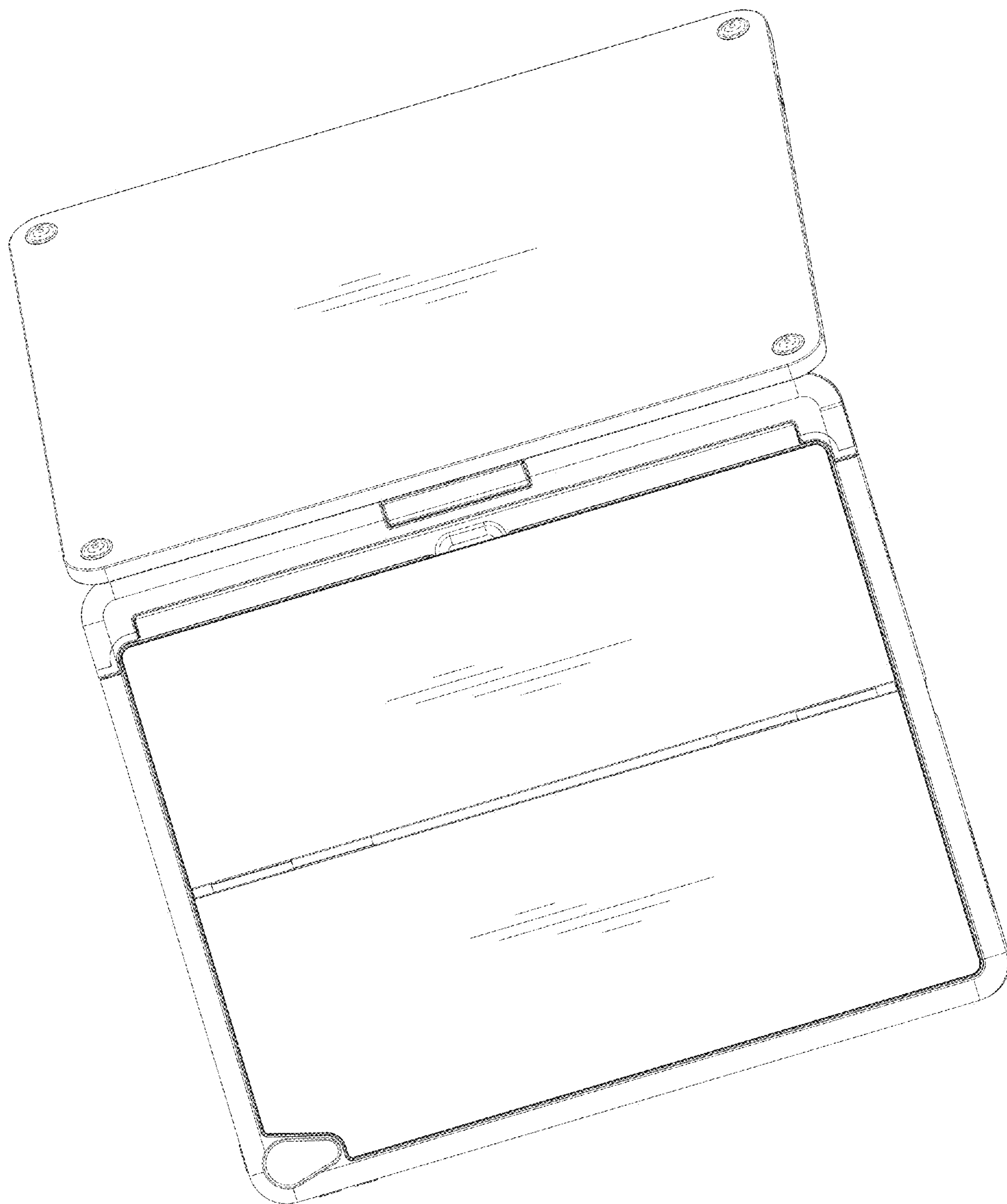

FIG. 2

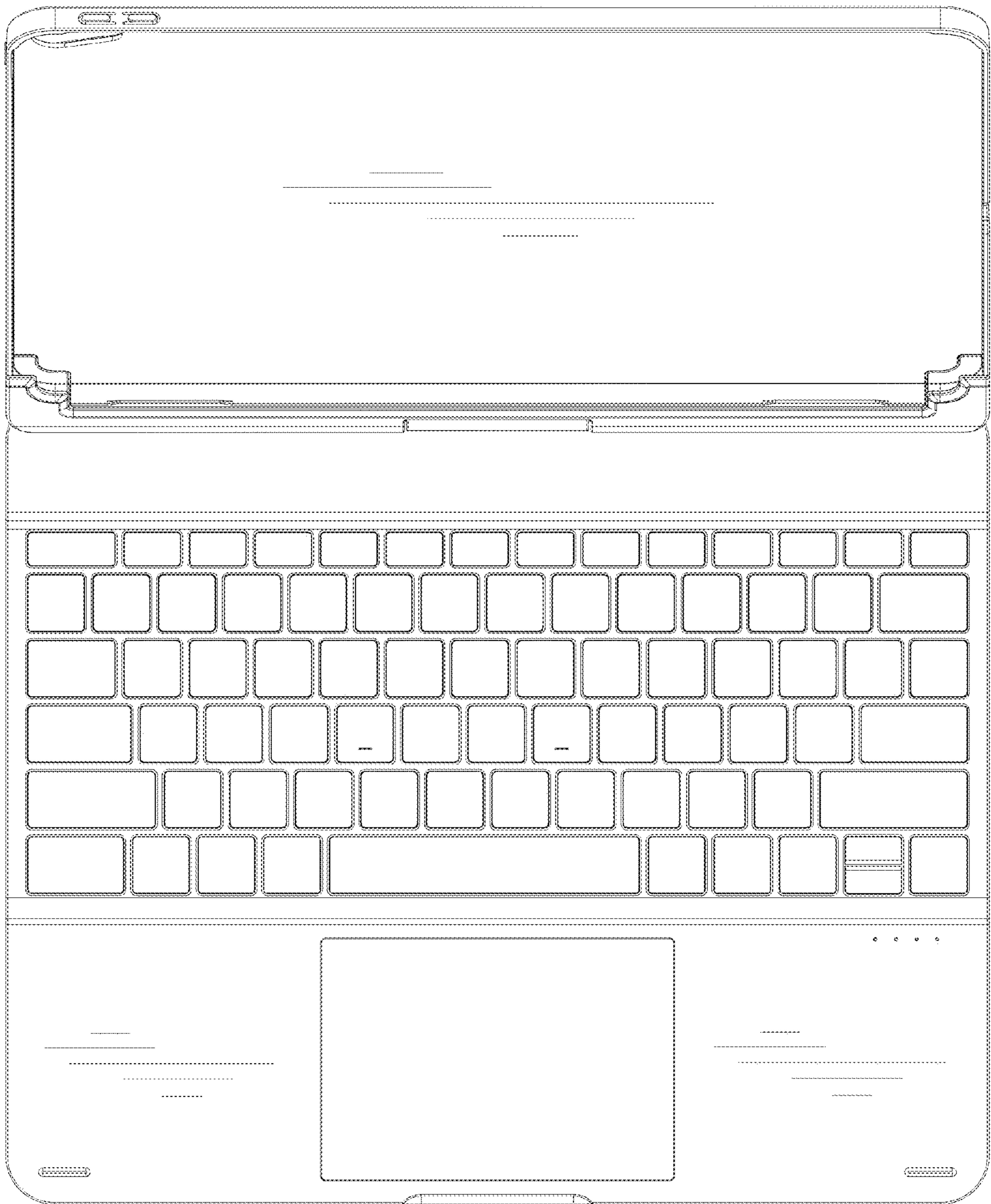

FIG. 3

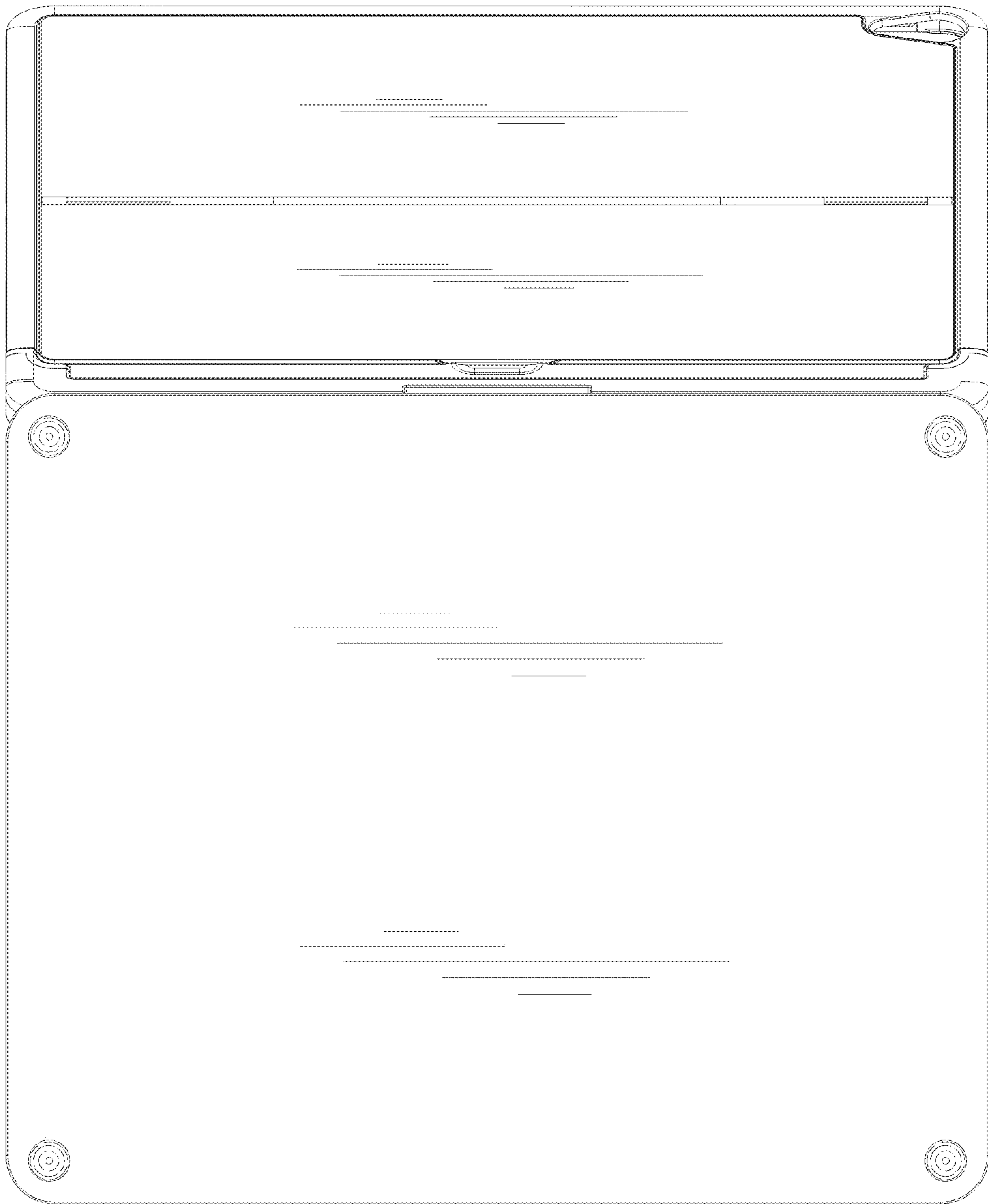

FIG. 4

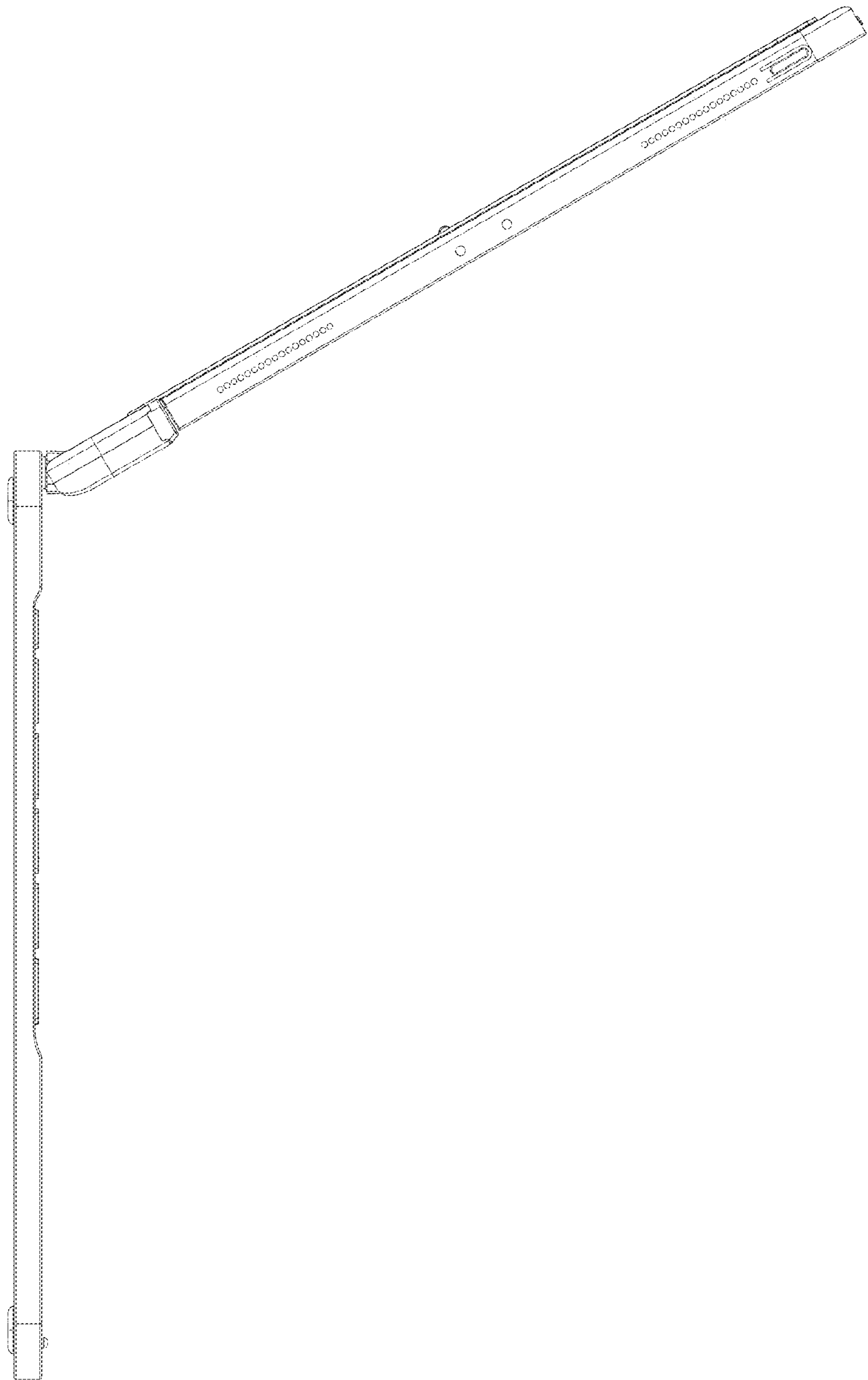

FIG. 5

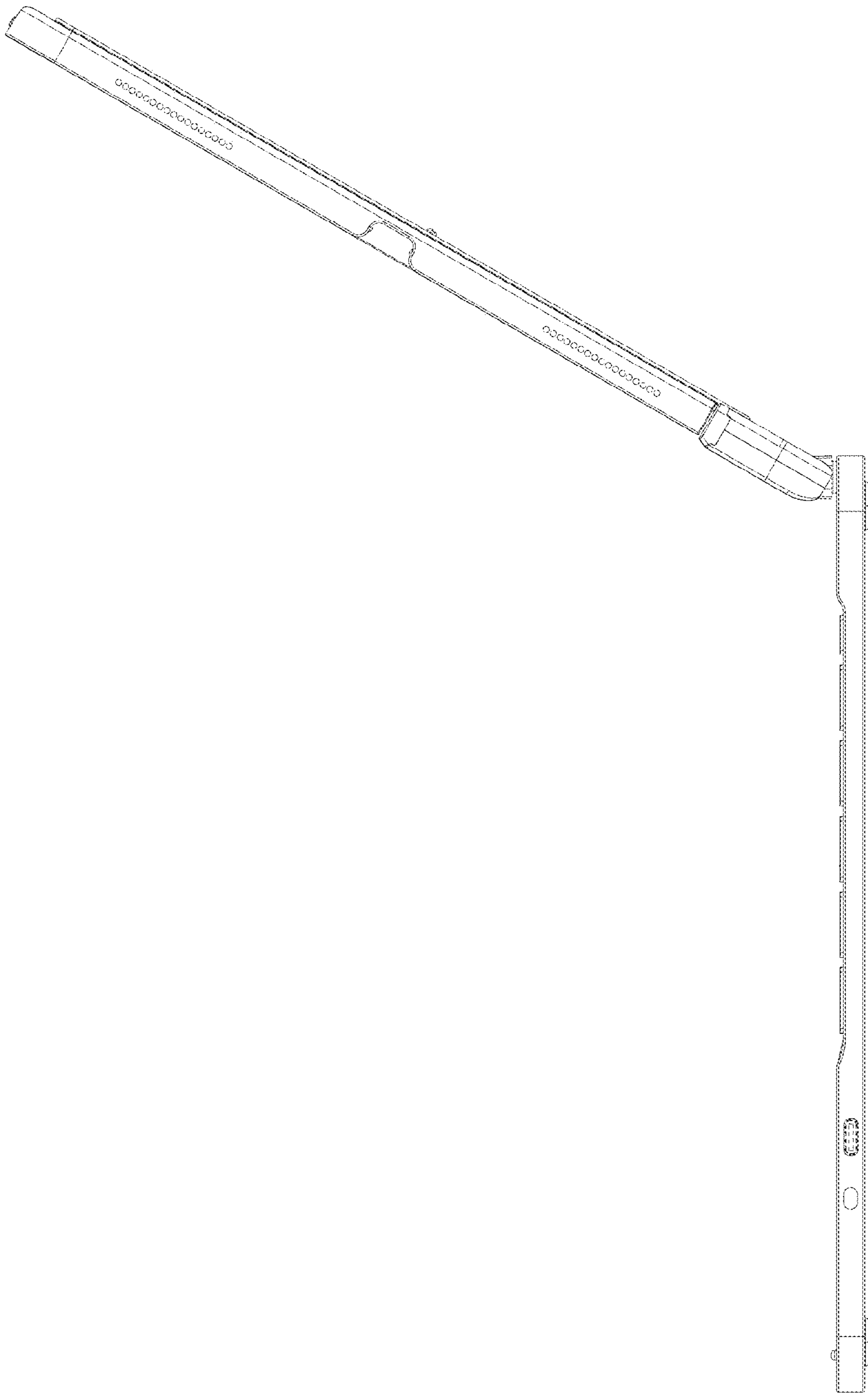

FIG. 6



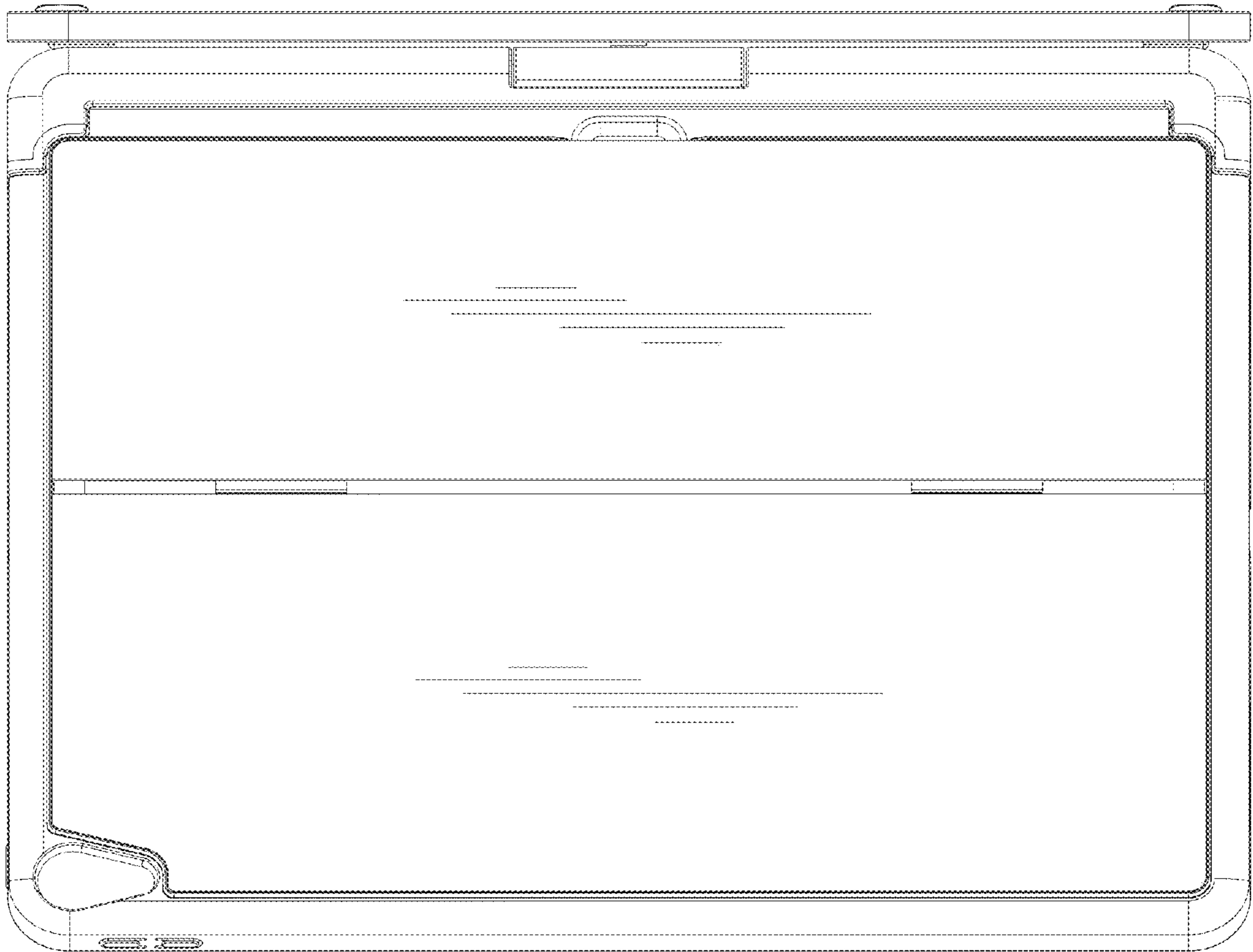

FIG. 7

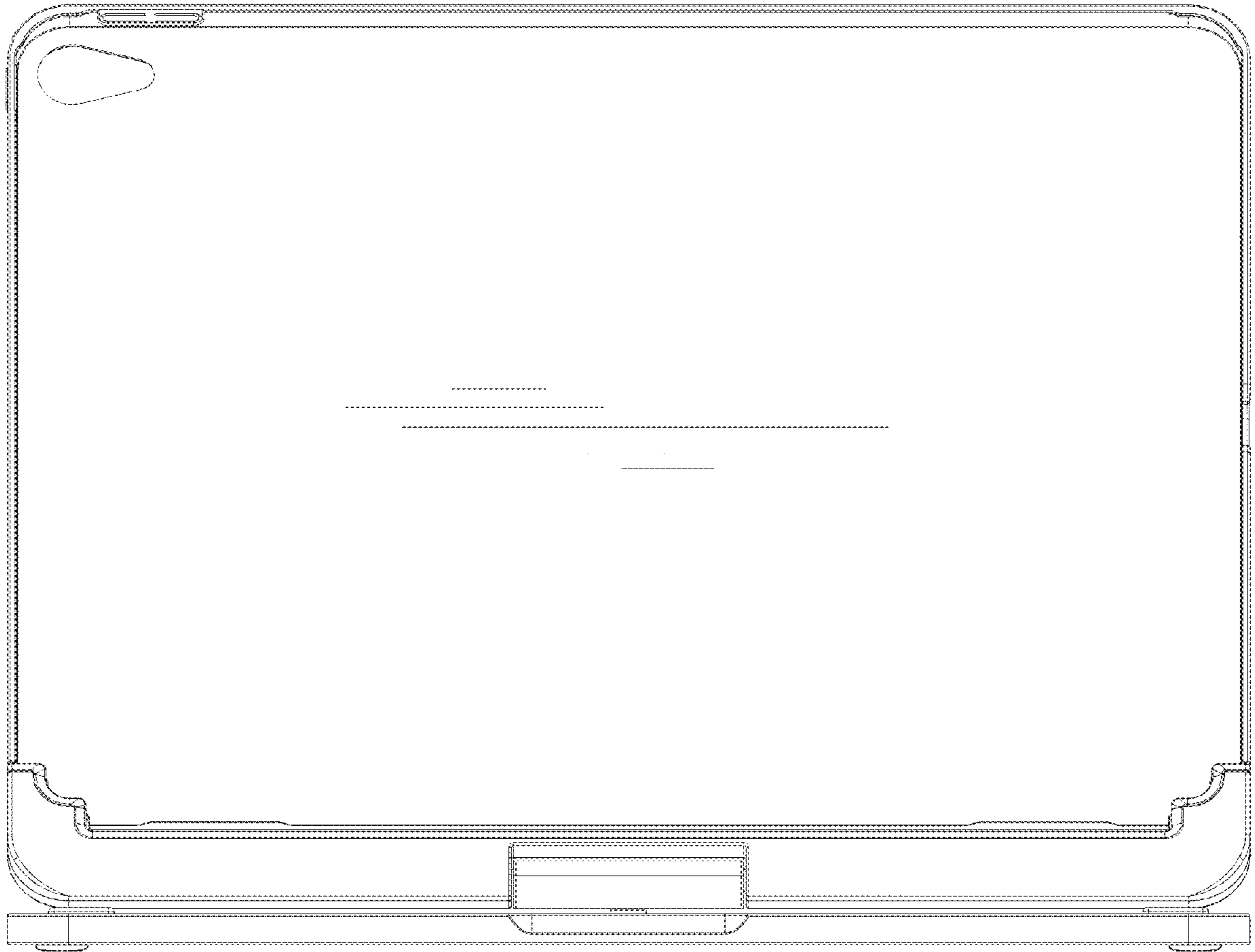

FIG. 8

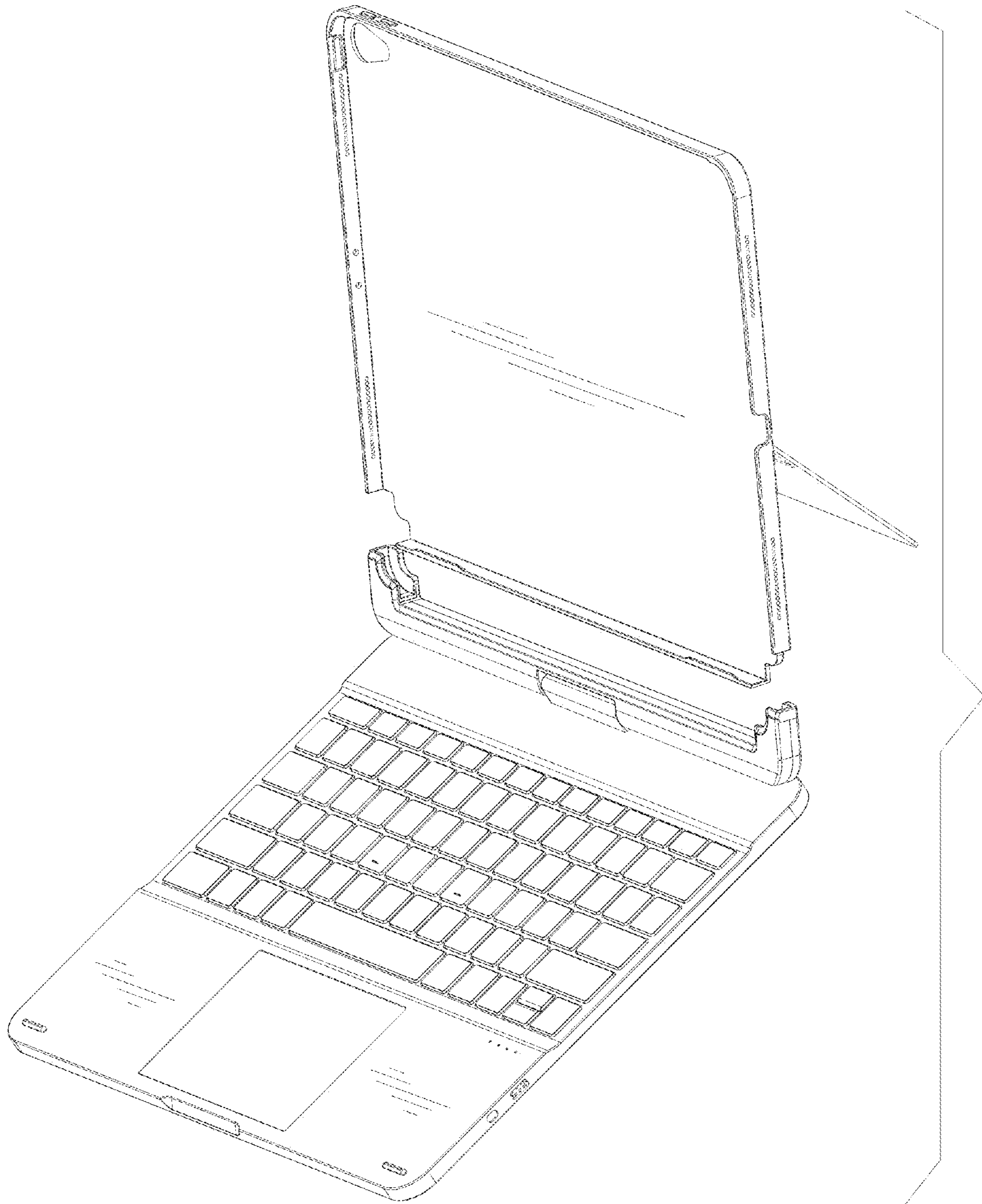

FIG. 9

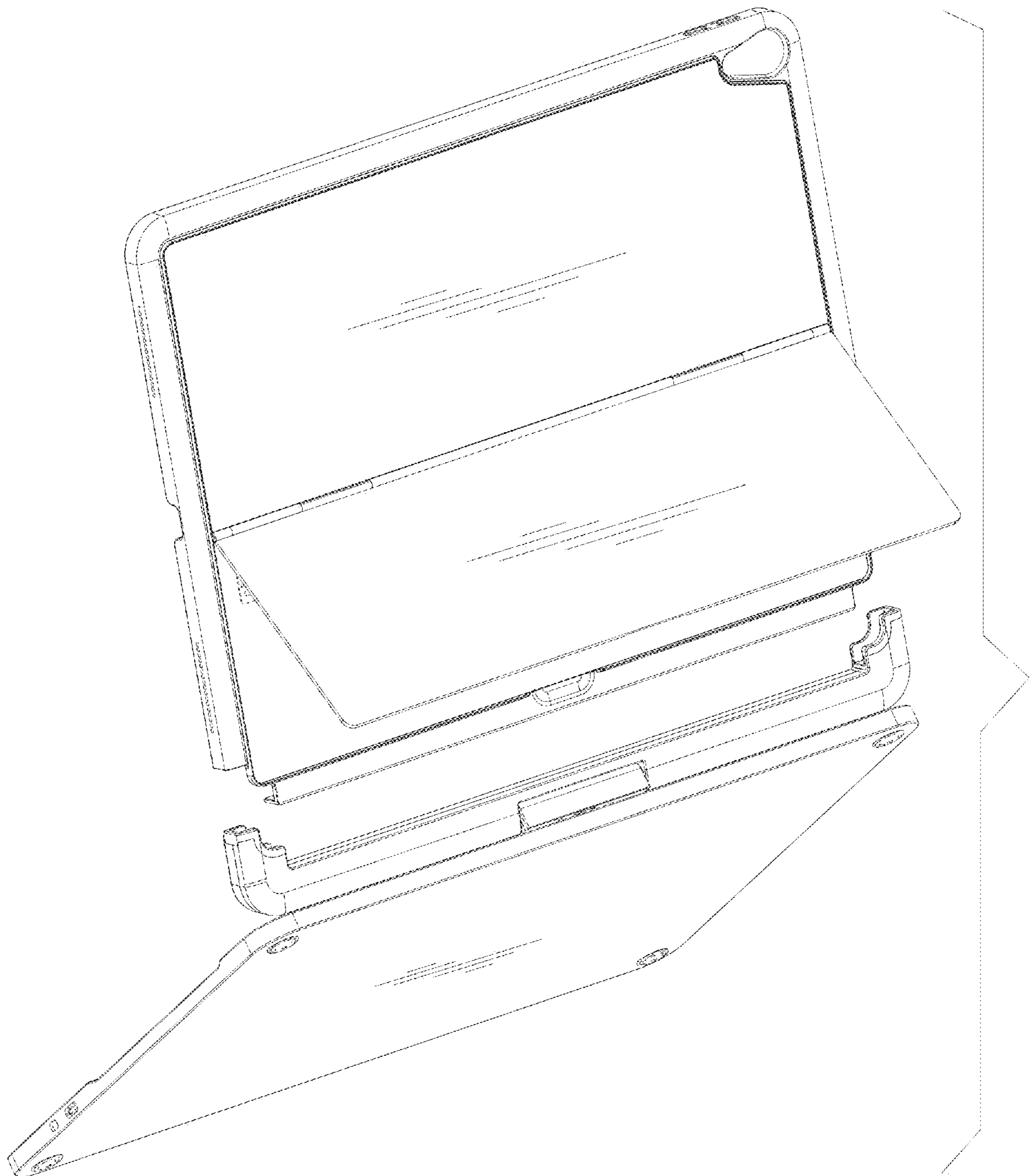

FIG. 10

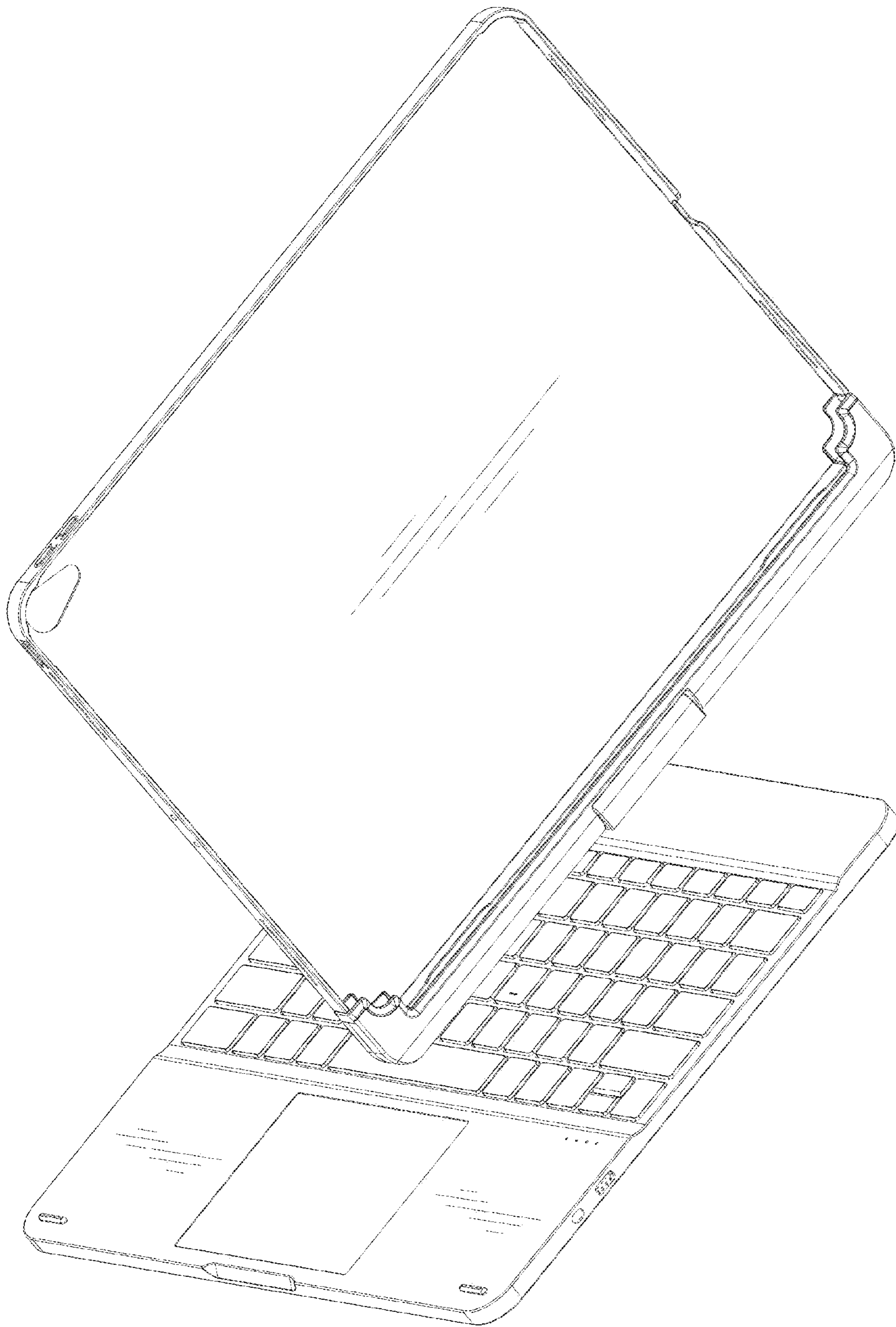

FIG. 11