



US00D969789S

(12) **United States Design Patent**
Wang

(10) **Patent No.:** **US D969,789 S**

(45) **Date of Patent:** **** Nov. 15, 2022**

(54) **ROUTER**

(71) Applicant: **BEIJING XIAOMI MOBILE SOFTWARE CO., LTD.**, Beijing (CN)

(72) Inventor: **Yuelong Wang**, Beijing (CN)

(73) Assignee: **BEIJING XIAOMI MOBILE SOFTWARE CO., LTD.**, Beijing (CN)

(**) Term: **15 Years**

(21) Appl. No.: **35/512,708**

(22) Filed: **Jun. 17, 2021**

(80) **Hague Agreement Data**

Int. Filing Date: **Jun. 17, 2021**

Int. Reg. No.: **DM/216488**

Int. Reg. Date: **Jun. 17, 2021**

Int. Reg. Pub. Date: **Oct. 8, 2021**

(30) **Foreign Application Priority Data**

Dec. 18, 2020 (CN) 202030785730.3

(51) **LOC (13) Cl.** **14-03**

(52) **U.S. Cl.**
USPC **D14/242**

(58) **Field of Classification Search**
USPC D14/240, 242, 357, 358, 140-140.9, 155,
D14/125, 137, 139, 243, 348, 349, 351,
D14/354, 355, 433

CPC H04L 12/00; H03K 17/00; H04W 88/00;
H04W 88/005; H04W 88/02; H04W
88/08; H04W 88/085; H04W 88/10;
H04W 88/12; H04W 88/14; H04B 1/38

See application file for complete search history.

(56) **References Cited**

U.S. PATENT DOCUMENTS

D471,542 S * 3/2003 Sim D14/240
D487,892 S * 3/2004 Ogura D14/356

D702,686 S * 4/2014 Gerber D14/433
D746,290 S * 12/2015 Spinella D14/433
D793,398 S * 8/2017 Feldstein D14/433
D811,377 S * 2/2018 Wang D14/240
D817,941 S * 5/2018 Wang D14/242
D883,294 S * 5/2020 Xie D14/433
D892,776 S * 8/2020 Ramones D14/240
D912,031 S * 3/2021 He D14/242
D931,266 S * 9/2021 Chong D14/242
D934,212 S * 10/2021 Wang D14/242
D951,925 S * 5/2022 Diehl D14/240

FOREIGN PATENT DOCUMENTS

CN 305887299 S 6/2020
TW D157178 S 11/2013

* cited by examiner

Primary Examiner — Bridget L Eland

(74) *Attorney, Agent, or Firm* — Syncoda LLC; Feng Ma

(57) **CLAIM**

The ornamental design for a router, as shown and described.

DESCRIPTION

1. Router

FIG. 1.1 is a front elevation view of a router showing our new design;

FIG. 1.2 is a back elevation view thereof;

FIG. 1.3 is a left side elevation view thereof;

FIG. 1.4 is a right side elevation view thereof;

FIG. 1.5 is a top plan view thereof;

FIG. 1.6 is a bottom plan view thereof;

FIG. 1.7 is a top perspective view thereof; and

FIG. 1.8 is a bottom perspective view thereof.

The product consists of an octagonal conical platform body and four rectangular ring antennas; four antennas are mounted on four sides of the body at intervals; on the top surface of the body, there are four cross distributed rectangular heat sinks.

1 Claim, 8 Drawing Sheets

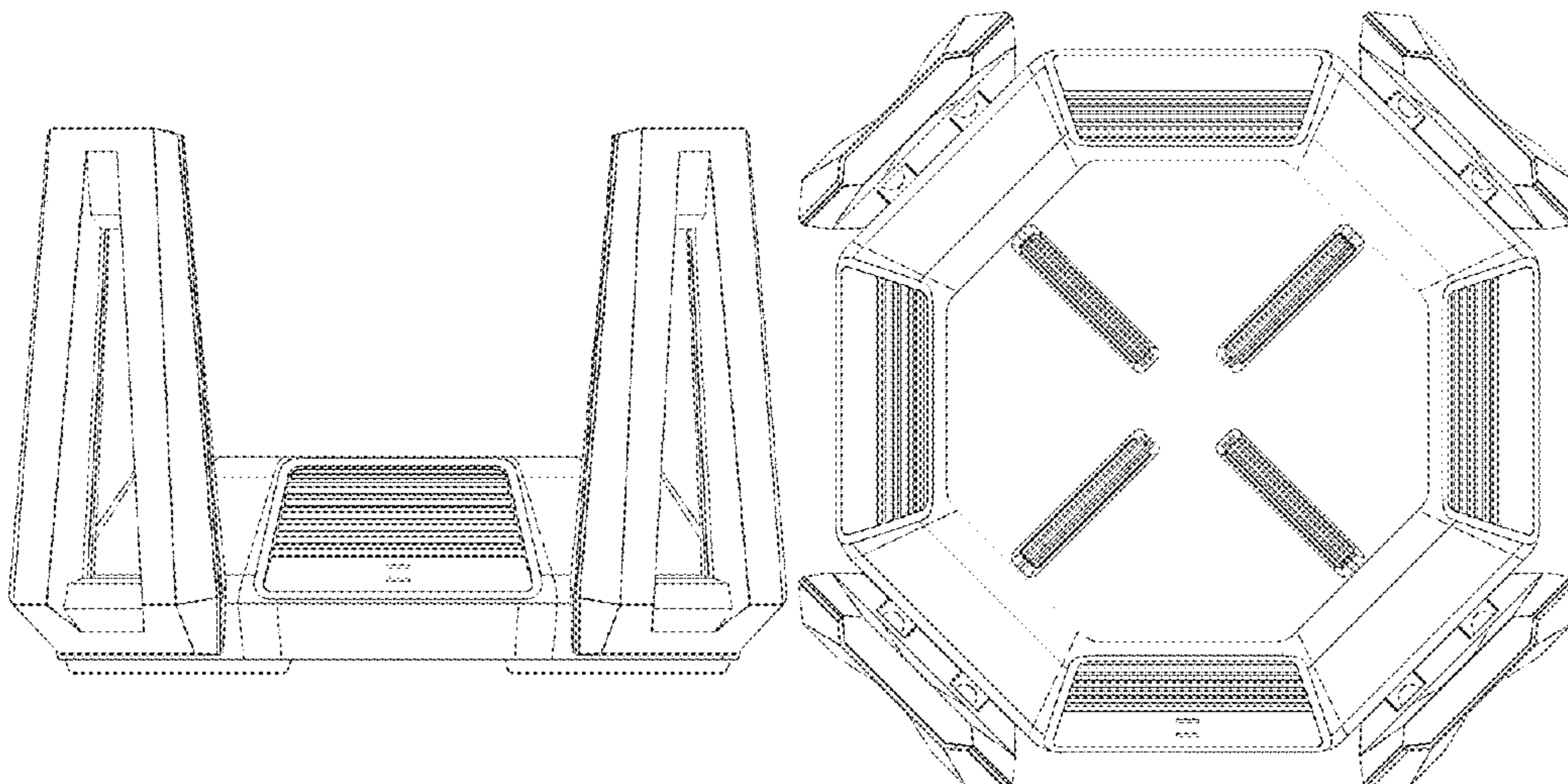

1.1

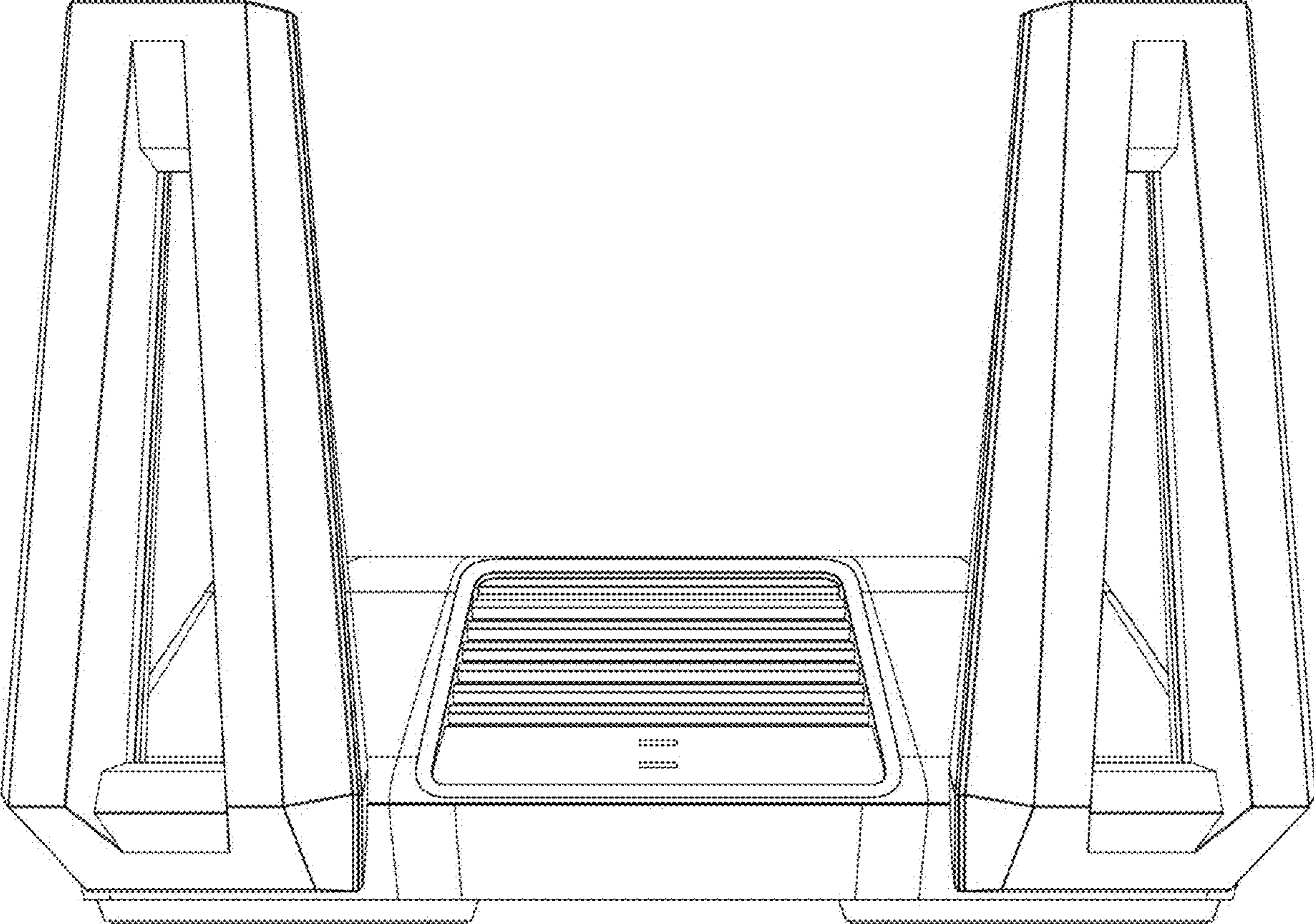

1.2

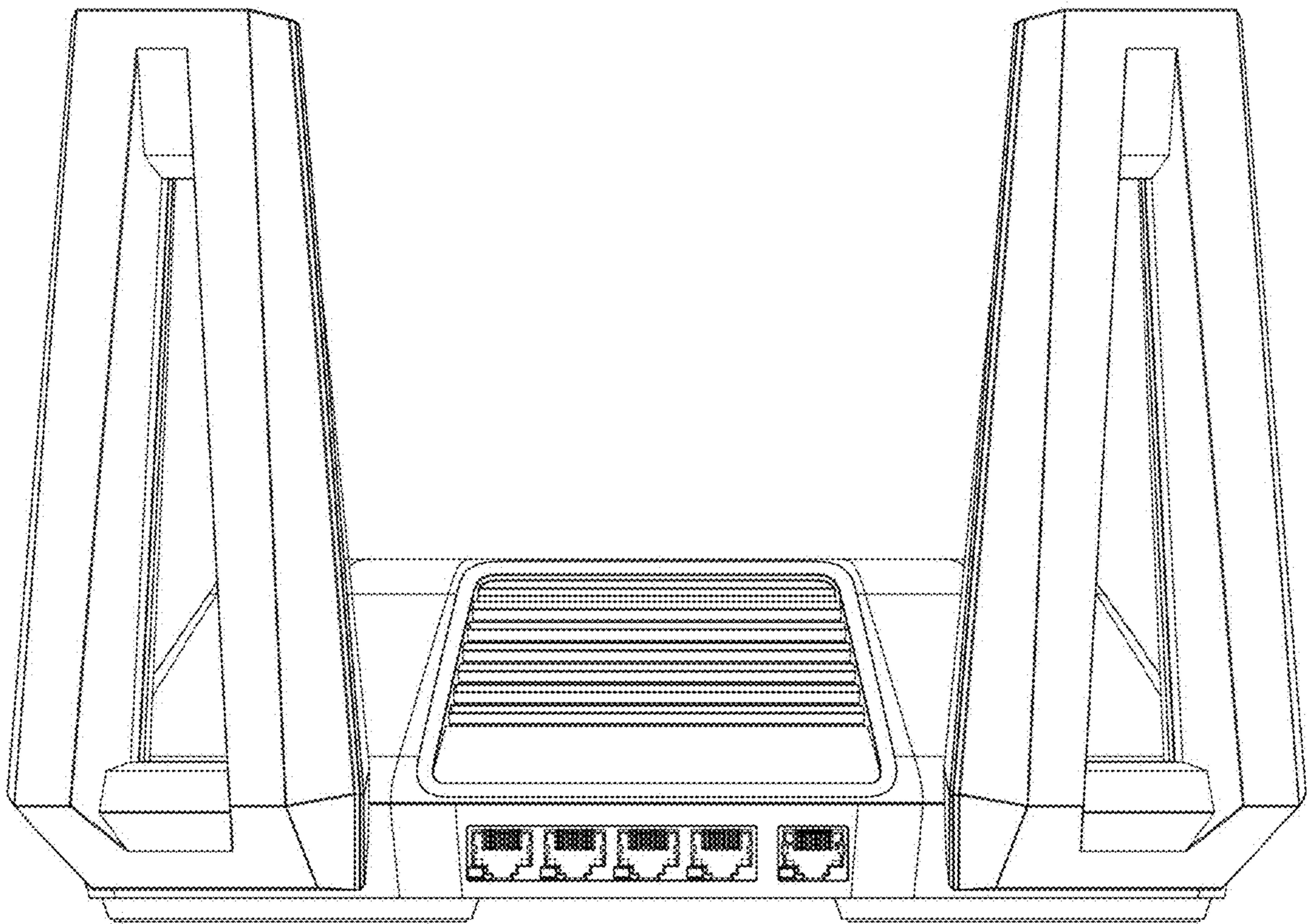

1.3

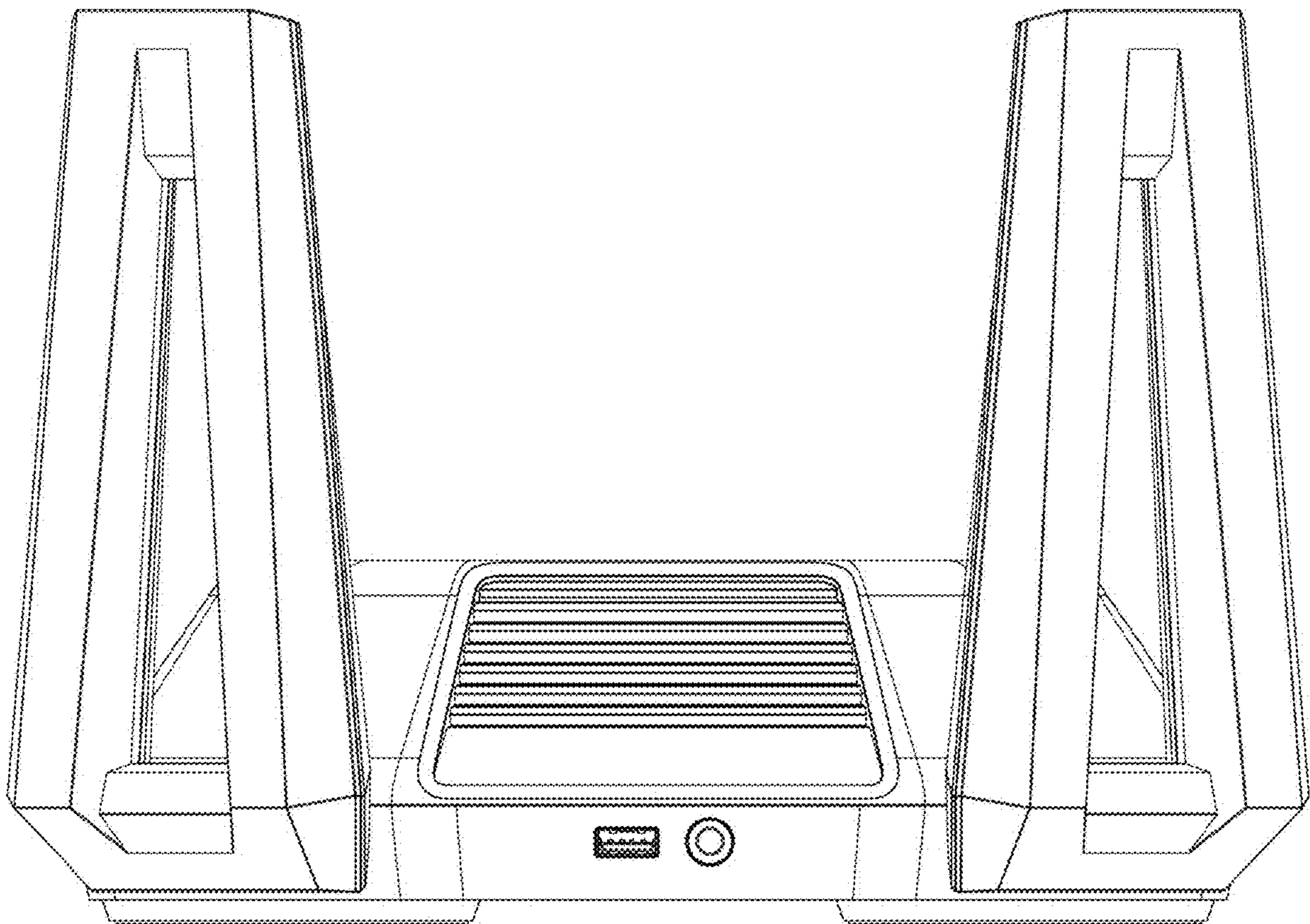

1.4

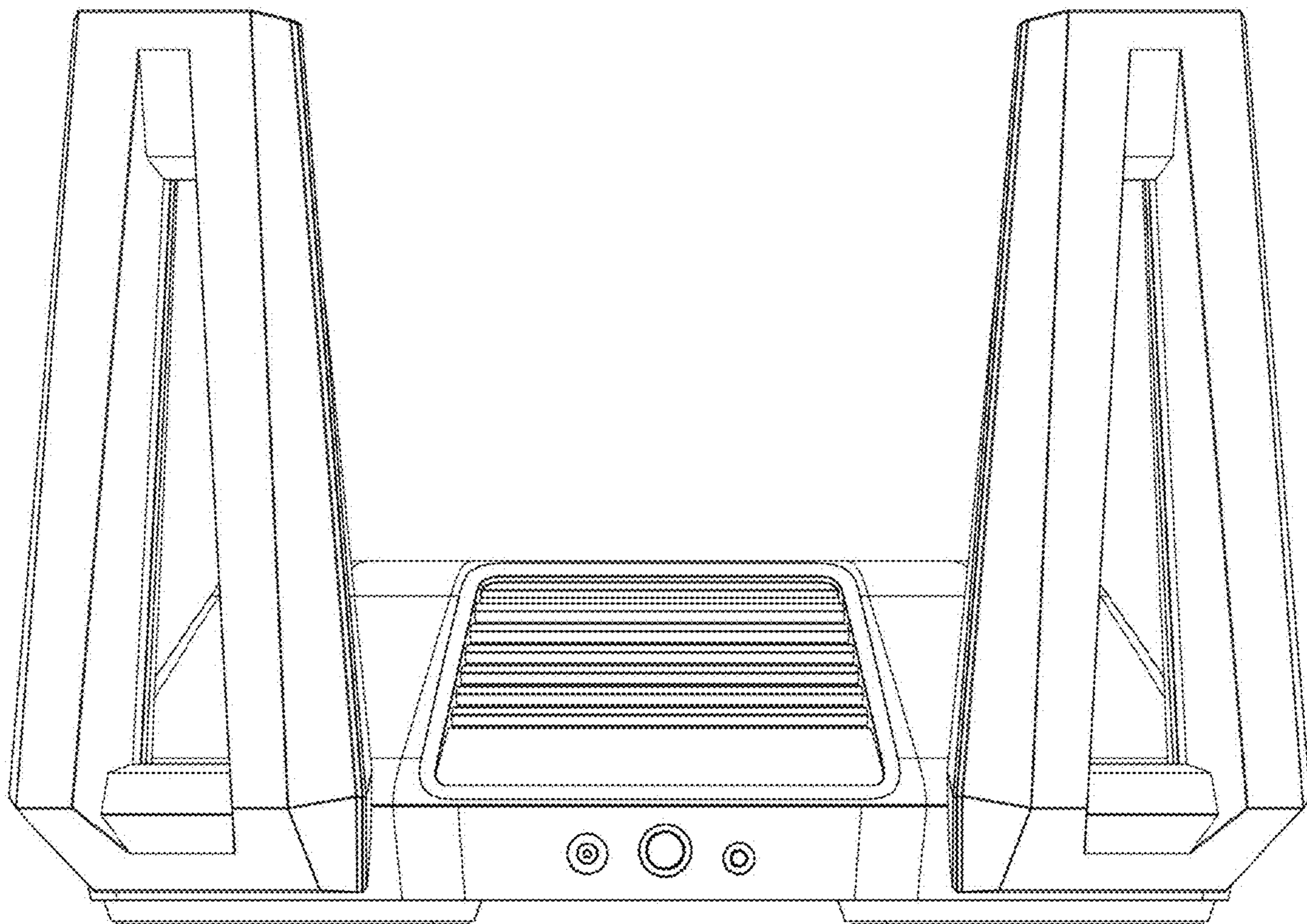

1.5

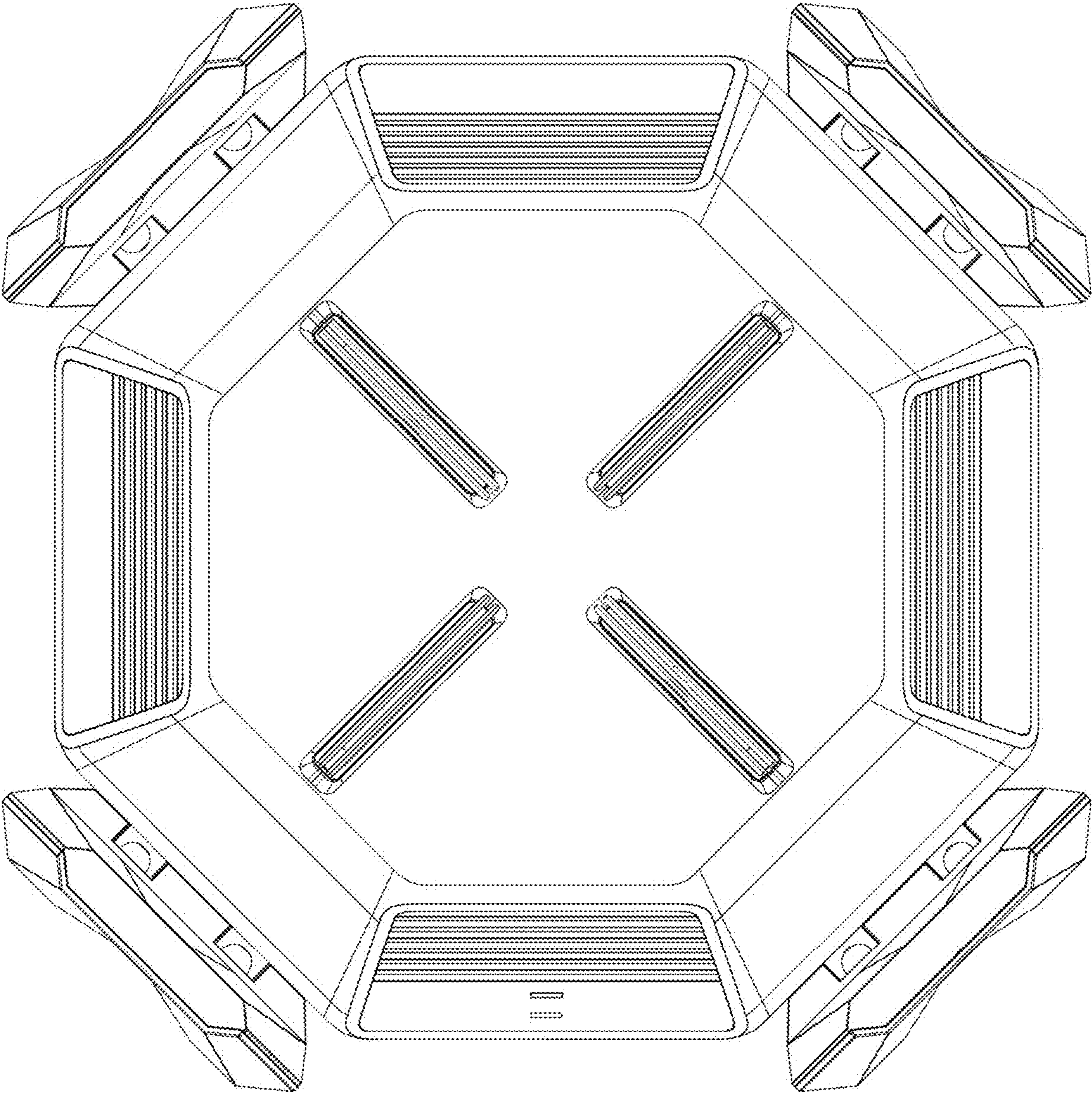

1.6

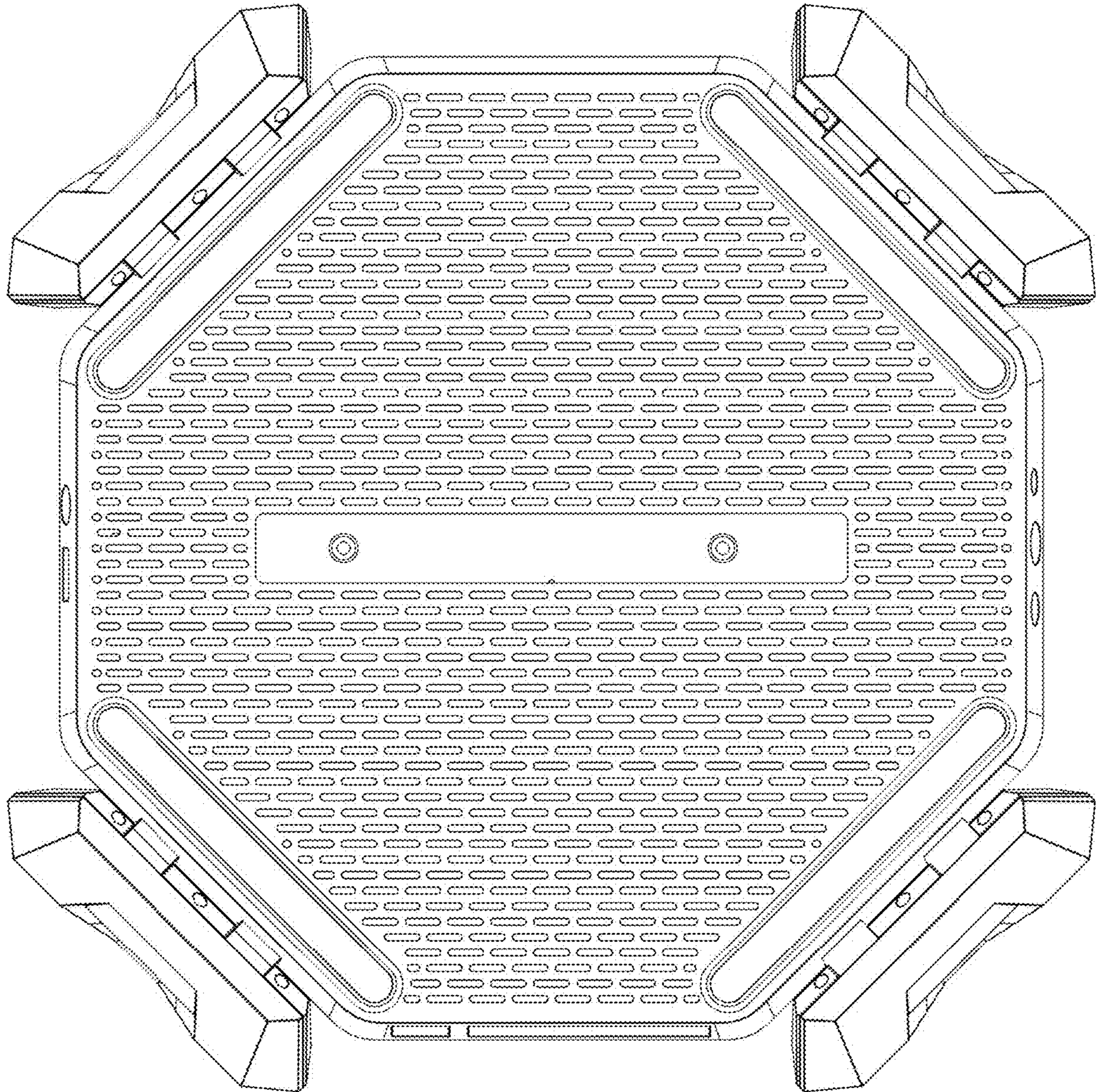

1.7

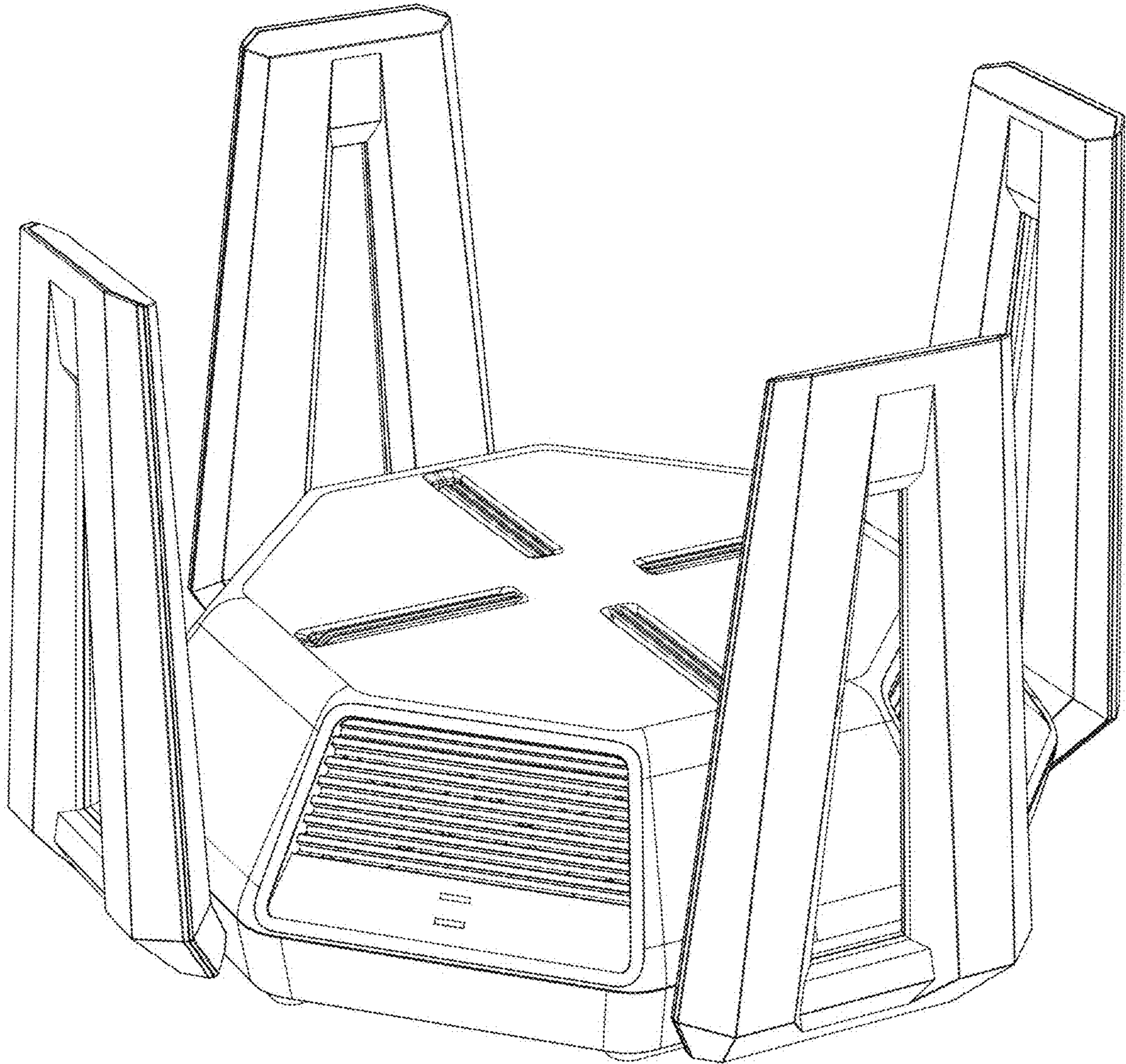

1.8

