

US00D969679S

(12) **United States Design Patent**
Buller et al.

(10) **Patent No.:** **US D969,679 S**

(45) **Date of Patent:** **** Nov. 15, 2022**

- (54) **VEHICLE FRONT BUMPER PLATE**
- (71) Applicant: **GM GLOBAL TECHNOLOGY OPERATIONS LLC**, Detroit, MI (US)
- (72) Inventors: **Rebecka A Buller**, Pleasant Ridge, MI (US); **Eduardo H. Mine**, Sterling Heights, MI (US)
- (73) Assignee: **GM Global Technology Operations LLC**, Detroit, MI (US)
- (**) Term: **15 Years**
- (21) Appl. No.: **29/770,630**
- (22) Filed: **Feb. 15, 2021**
- (51) **LOC (13) Cl.** **12-16**
- (52) **U.S. Cl.**
USPC **D12/169**
- (58) **Field of Classification Search**
USPC D12/169, 196, 86, 90-92, 163, 190, 98, D12/164; 293/102, 113, 115, 117, 120, 293/193.11; 296/180.1, 180.2
CPC B60R 19/02; B60R 19/04; B62D 25/08
See application file for complete search history.

- D775,010 S 12/2016 Kim et al.
- D776,583 S 1/2017 Scheer et al.
- D786,149 S 5/2017 Pevovar et al.
- D787,990 S 5/2017 Kozub et al.
- D792,293 S 7/2017 McCabe et al.
- D792,295 S 7/2017 McCabe et al.
- D792,815 S 7/2017 Kozub
- D792,816 S 7/2017 Kozub
- D793,292 S 8/2017 Lee
- D793,293 S 8/2017 Lee et al.
- D793,296 S 8/2017 Smith et al.
- D793,297 S 8/2017 Smith et al.
- D793,301 S 8/2017 Kozub
- D793,302 S 8/2017 Kozub
- D798,204 S 9/2017 Mainville
- D802,496 S 11/2017 Mainville
- D811,957 S 3/2018 Whitla et al.
- D811,960 S 3/2018 Nakamura
- D811,964 S 3/2018 Perkins
- D812,526 S 3/2018 Zipfel
- D812,527 S 3/2018 Perkins

(Continued)

Primary Examiner — Melody N Brown

(57) **CLAIM**

The ornamental design for a vehicle front bumper plate, as shown and described.

DESCRIPTION

FIG. 1 is a front and left side perspective view of a vehicle front bumper plate showing my new design;
 FIG. 2 is a front elevation view thereof;
 FIG. 3 is a left side elevation view thereof;
 FIG. 4 is a right side elevation view thereof;
 FIG. 5 is a top plan view thereof;
 FIG. 6 is a rear elevation view thereof; and,
 FIG. 7 is a bottom plan view thereof.
 The broken lines in the drawings depict portions of the vehicle front bumper plate that form no part of the claimed design.

1 Claim, 7 Drawing Sheets

- (56) **References Cited**
U.S. PATENT DOCUMENTS
- D717,703 S 11/2014 Munson et al.
- D720,668 S 1/2015 Pevovar et al.
- D745,837 S 12/2015 Smith et al.
- D749,021 S 2/2016 Boniface et al.
- D753,034 S 4/2016 Thole et al.
- D753,559 S 4/2016 McMahan et al.
- D753,560 S 4/2016 McMahan et al.
- D771,532 S 11/2016 Kapitonov
- D771,533 S 11/2016 Kapitonov
- D772,766 S 11/2016 Kozub et al.
- D772,767 S 11/2016 Kim
- D775,007 S 12/2016 Thole et al.

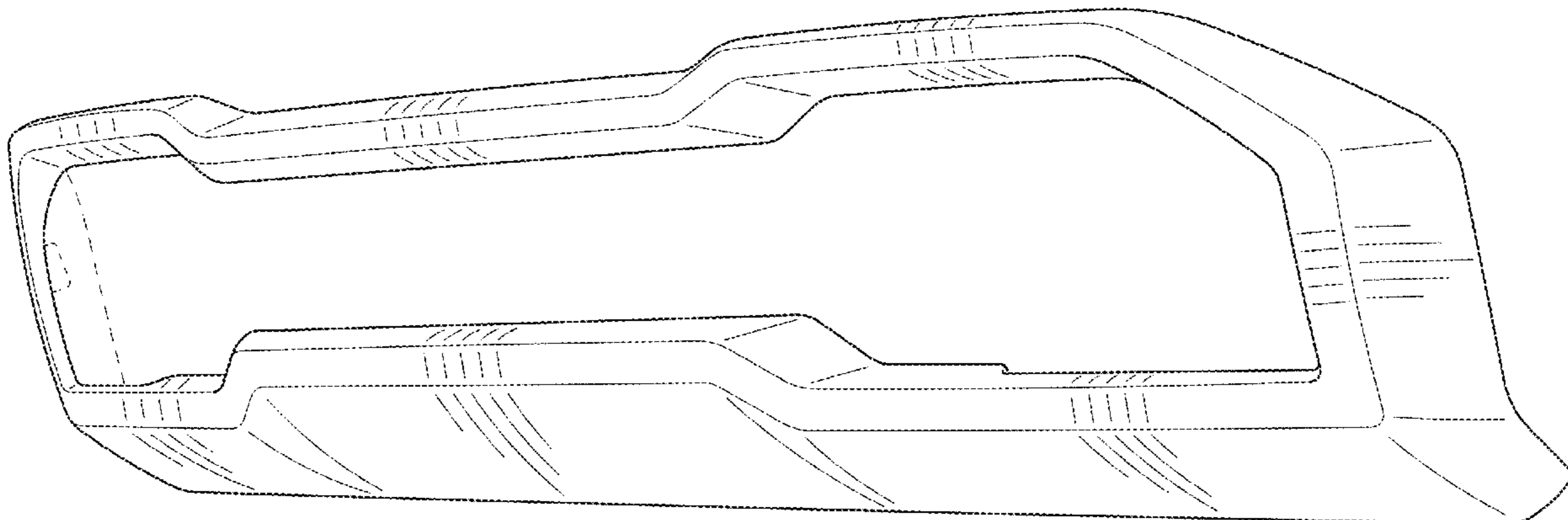

(56)

References Cited

U.S. PATENT DOCUMENTS

D812,528 S	3/2018	Nakamura	D855,508 S	8/2019	Wilkins et al.
D813,109 S	3/2018	Zipfel et al.	D855,509 S	8/2019	Wilkins
D813,734 S	3/2018	Nakamura	D856,204 S	8/2019	Kapitonov
D814,369 S	4/2018	Loeb	D856,206 S	8/2019	De Leon
D816,558 S	5/2018	McMahan et al.	D856,864 S	8/2019	Kapitonov
D816,559 S	5/2018	McMahan et al.	D856,874 S	8/2019	Kozub
D816,561 S	5/2018	McMahan	D856,875 S	8/2019	Kozub
D816,562 S	5/2018	Whitla et al.	D860,075 S	9/2019	Riggs et al.
D816,564 S	5/2018	Kim	D860,076 S	9/2019	Bartels et al.
D816,566 S	5/2018	Loeb	D860,078 S	9/2019	O'Donnell et al.
D818,406 S	5/2018	McMahan et al.	D862,337 S	10/2019	Pinazzo et al.
D820,173 S	6/2018	McMahan	D863,140 S	10/2019	Wilkins et al.
D820,174 S	6/2018	Whitla et al.	D863,147 S	10/2019	Zipfel
D821,941 S	7/2018	Mack et al.	D863,149 S	10/2019	Luke et al.
D821,950 S	7/2018	Kozub	D863,150 S	10/2019	Krieg et al.
D822,550 S	7/2018	Wassell et al.	D863,152 S	10/2019	Kozub
D826,114 S	8/2018	Smith et al.	D864,057 S	10/2019	Krieg et al.
D826,803 S	8/2018	Smith et al.	D867,232 S	11/2019	Izard
D837,109 S	1/2019	Kozub et al.	D868,639 S	12/2019	Wilkins et al.
D840,293 S	2/2019	Koo et al.	D868,650 S	12/2019	Gifford
D841,532 S	2/2019	Koo et al.	D868,651 S	12/2019	Gifford
D843,275 S	3/2019	Koo et al.	D868,656 S	12/2019	De Leon
D845,187 S	4/2019	Pinazzo et al.	D870,619 S	12/2019	Gifford
D845,190 S	4/2019	Zipfel	D873,733 S	1/2020	Kozub
D845,196 S	4/2019	Kozub	D874,362 S	2/2020	Izard
D847,042 S	4/2019	Pinazzo et al.	D877,001 S	3/2020	Izard
D847,044 S	4/2019	Zipfel	D877,002 S	3/2020	Izard
D847,704 S	5/2019	Zipfel	D877,003 S	3/2020	Izard
D847,705 S	5/2019	Zipfel	D877,004 S	3/2020	Wilkins et al.
D847,707 S	5/2019	Park Cheng et al.	D877,007 S	3/2020	Zipfel
D847,714 S	5/2019	Mack et al.	D877,009 S	3/2020	Luke et al.
D848,318 S	5/2019	McMahan et al.	D881,083 S	4/2020	Blanski et al.
D848,322 S	5/2019	Mack et al.	D882,466 S	4/2020	Yong et al.
D848,323 S	5/2019	Mack et al.	D885,265 S	5/2020	Zipfel
D848,324 S	5/2019	Thurber et al.	D887,323 S	6/2020	Zipfel
D848,325 S	5/2019	Thurber et al.	D889,331 S	7/2020	O'Donnell et al.
D850,989 S	6/2019	Kozub	D892,003 S *	8/2020	Zipfel D12/169
D851,555 S	6/2019	Whitla et al.	D894,060 S	8/2020	Izard
D851,556 S	6/2019	Thurber et al.	D894,061 S	8/2020	Zipfel
D851,557 S	6/2019	Thurber et al.	D902,802 S	11/2020	Choi et al.
D851,560 S	6/2019	Yong et al.	D902,803 S	11/2020	Choi et al.
D851,561 S	6/2019	Yong et al.	D902,817 S	11/2020	Choi et al.
D853,904 S	7/2019	Koo et al.	D902,818 S *	11/2020	Choi D12/196
D854,979 S	7/2019	Krieg et al.	D903,567 S	12/2020	Choi et al.
			D930,528 S *	9/2021	Buller D12/169
			D937,150 S *	11/2021	Wraith D12/169

* cited by examiner

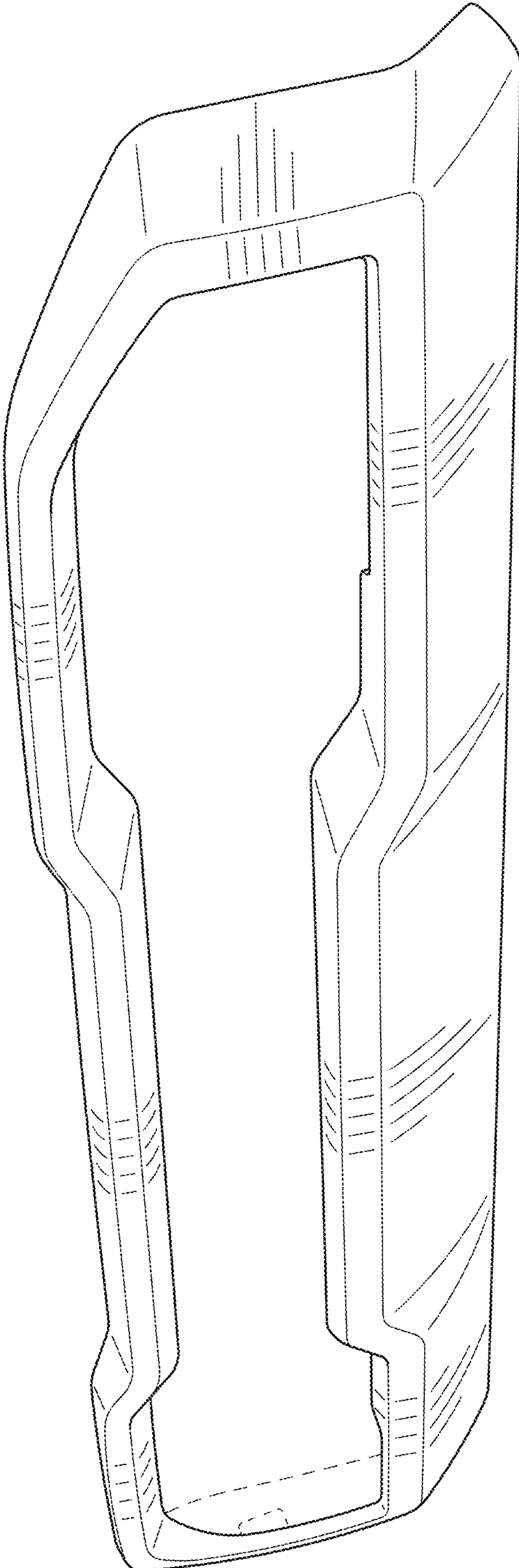

FIG. 1

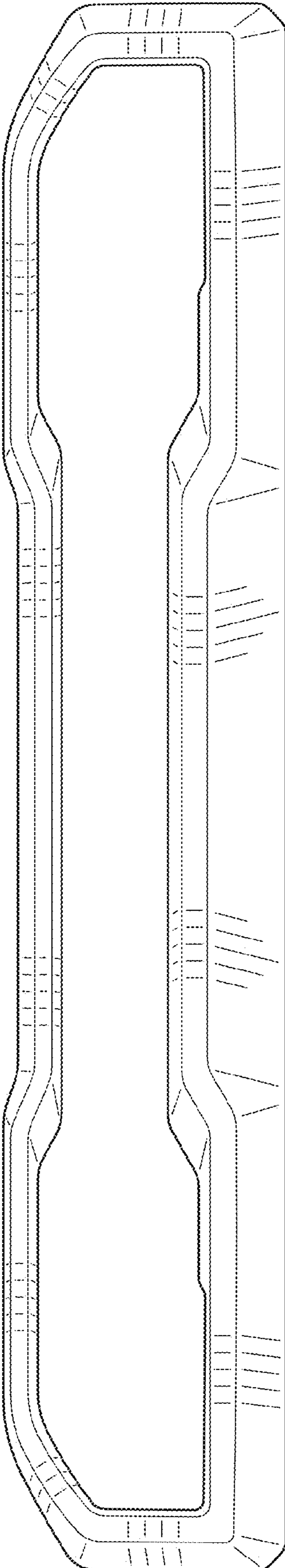

FIG. 2

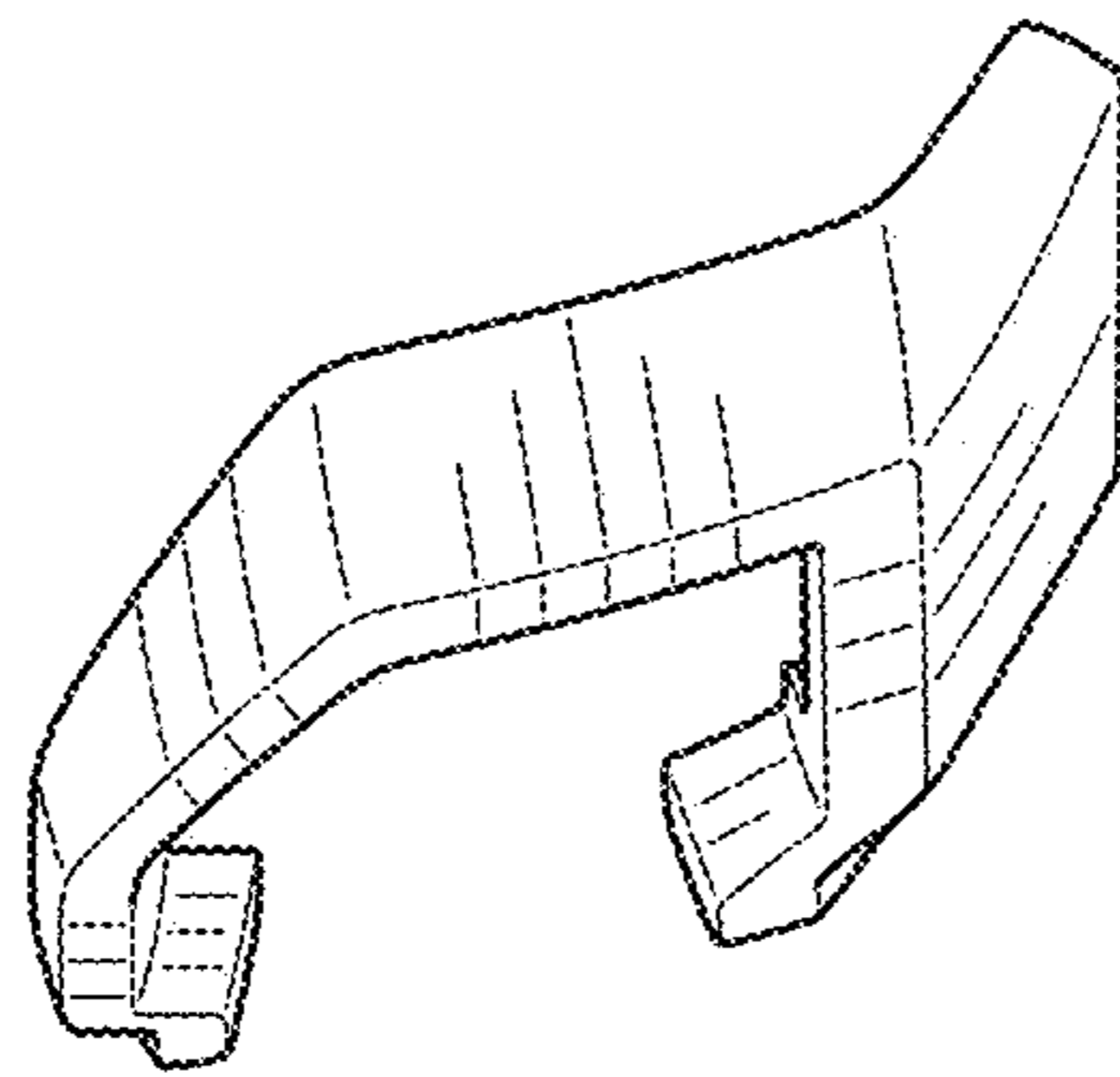

FIG. 3

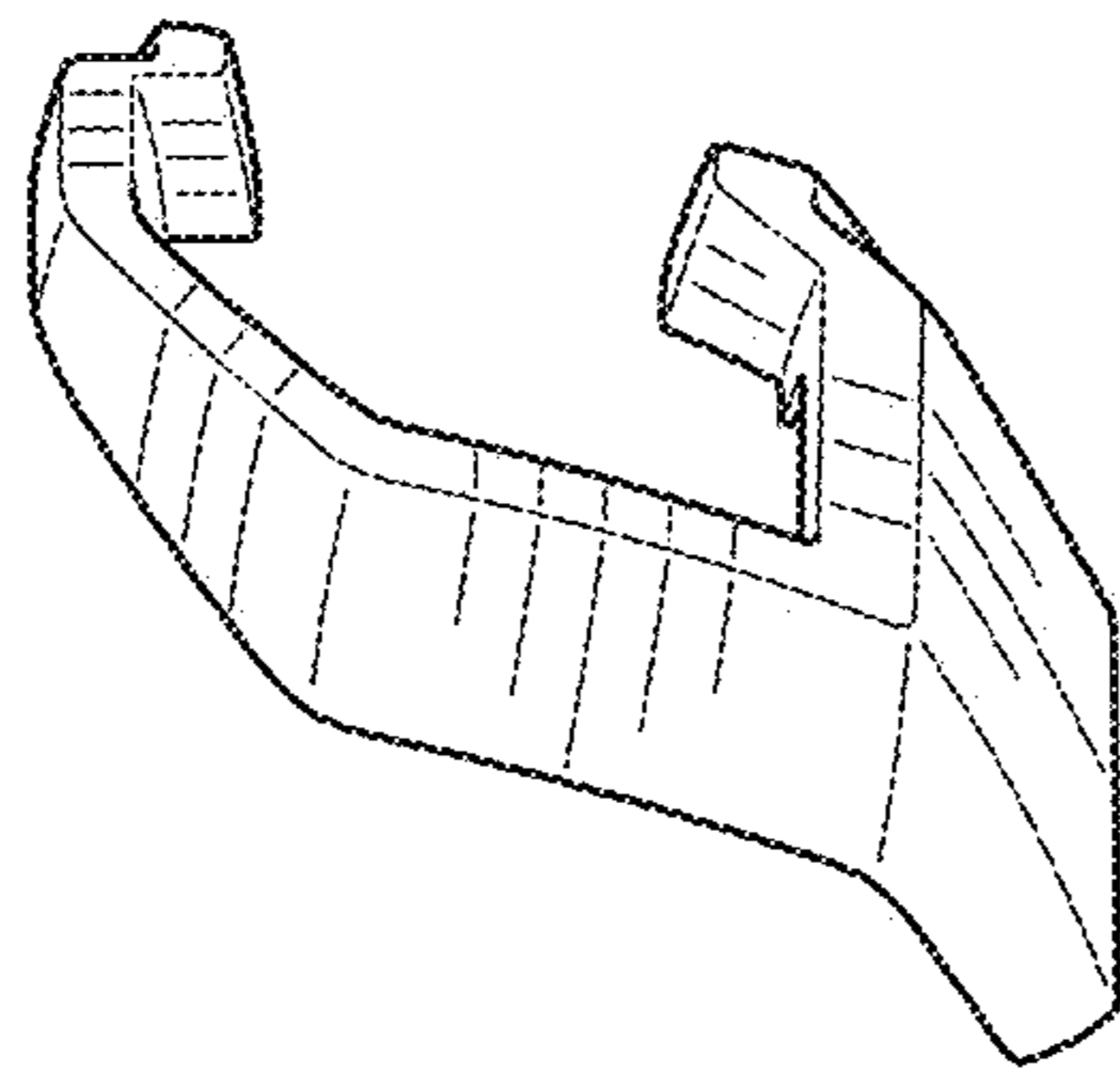

FIG. 4

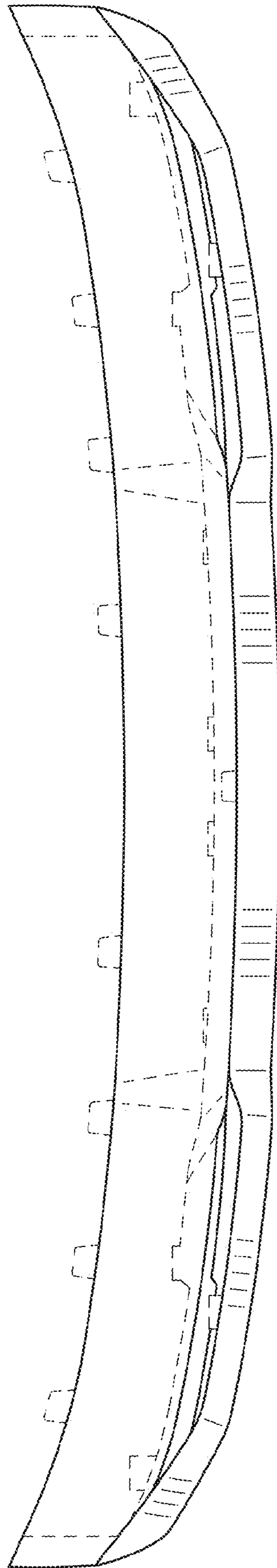

FIG. 5

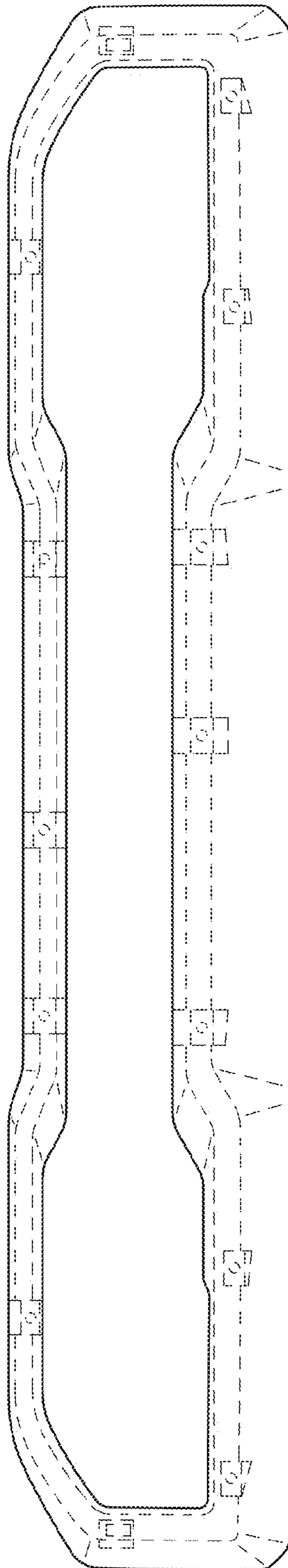

FIG. 6

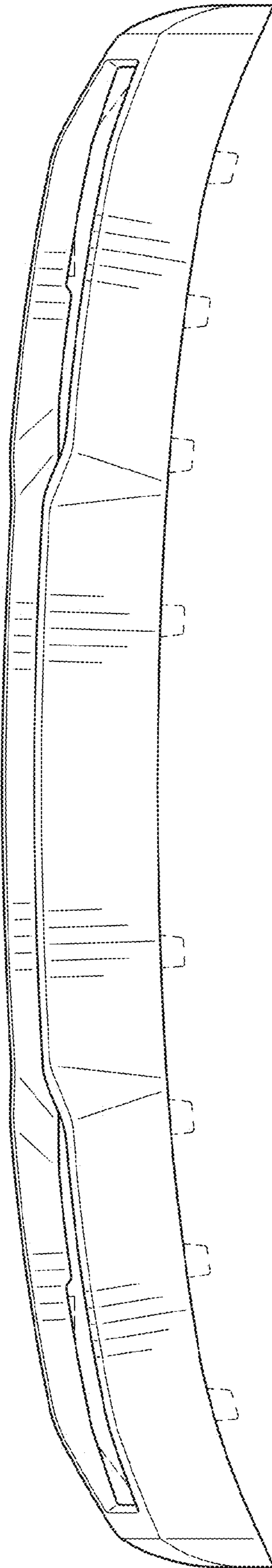

FIG. 7