

US00D969666S

(12) **United States Design Patent** (10) **Patent No.:** **US D969,666 S**  
**Boyd** (45) **Date of Patent:** **\*\* Nov. 15, 2022**

(54) **JEWELRY CLASP**

(71) Applicant: **Charmed by LJB Inc.**, New York, NY (US)

(72) Inventor: **Lindsey Julia Boyd**, Miami Shores, FL (US)

(73) Assignee: **CHARMED BY LJB INC.**, New York, NY (US)

(\*\*) Term: **15 Years**

(21) Appl. No.: **29/767,970**

(22) Filed: **Jan. 26, 2021**

(51) **LOC (13) Cl.** ..... **11-01**

(52) **U.S. Cl.**  
USPC ..... **D11/87**

(58) **Field of Classification Search**  
USPC ..... D11/40, 86, 87, 200, 1, 3, 93, 7, 12, 13,  
D11/17, 79; D8/382, 354, 396  
(Continued)

(56) **References Cited**

**U.S. PATENT DOCUMENTS**

49,630 A \* 8/1865 Ives ..... F16B 45/02  
24/599.6  
838,976 A \* 12/1906 George ..... F16B 43/006  
24/518

(Continued)

**FOREIGN PATENT DOCUMENTS**

CA 139063 \* 9/2011  
CN 302973131 \* 10/2014  
CN 303690272 \* 6/2016

**OTHER PUBLICATIONS**

Signature Gold Charm Hook. Online [website]. Rondel Jewelry, publication date unknown [retrieved on Aug. 12, 2022]. Retrieved from the internet: <<https://rondeljewelry.com/products/signature-gold-charm-hook>>. (Year: 2022).\*

(Continued)

*Primary Examiner* — Tracey J Bell

*Assistant Examiner* — Grace Doyle

(74) *Attorney, Agent, or Firm* — Notaro, Michalos & Zaccaria P.C.

(57) **CLAIM**

The ornamental design for a jewelry clasp, as shown and described.

**DESCRIPTION**

FIG. 1 is a top, front, clasp-closed, perspective view of a jewelry clasp showing my design therefor;

FIG. 2 is a front, clasp-closed, side elevational view thereof;

FIG. 3 is a rear, clasp-closed, side elevational view thereof;

FIG. 4 is a right, clasp-closed, side elevational view thereof;

FIG. 5 is a left, clasp-closed, side elevational view thereof;

FIG. 6 is a top, clasp-closed, plan view thereof;

FIG. 7 is a bottom, clasp-closed, plan view thereof;

FIG. 8 is a top, front, clasp-opened, perspective view thereof;

FIG. 9 is a front, clasp-opened, side elevational view thereof;

FIG. 10 is a rear, clasp-opened, side elevational view thereof;

FIG. 11 is a right, clasp-opened, side elevational view thereof;

FIG. 12 is a left, clasp-opened, side elevational view thereof;

FIG. 13 is a top, clasp-opened, plan view thereof;

FIG. 14 is a bottom, clasp-opened, plan view thereof;

FIG. 15 is a top, front, clasp-closed, perspective view of a second embodiment of a jewelry clasp showing my design therefor;

FIG. 16 is a front, clasp-closed, side elevational view thereof;

FIG. 17 is a rear, clasp-closed, side elevational view thereof;

FIG. 18 is a right, clasp-closed, side elevational view thereof;

FIG. 19 is a left, clasp-closed, side elevational view thereof;

FIG. 20 is a top, clasp-closed, plan view thereof;

FIG. 21 is a bottom, clasp-closed, plan view thereof;

(Continued)

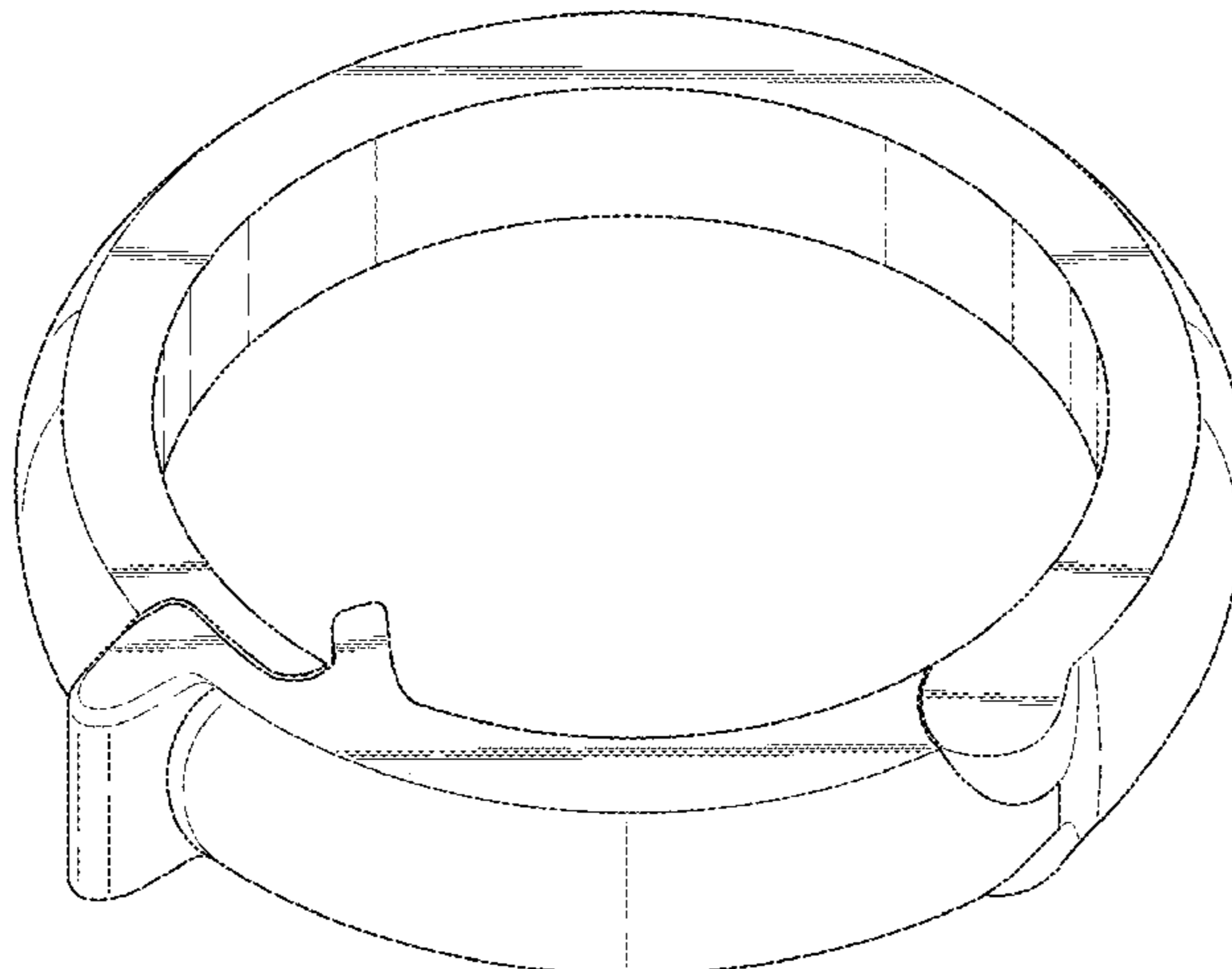

FIG. 22 is a top, front, clasp-opened, perspective view thereof;  
 FIG. 23 is a front, clasp-opened, side elevational view thereof;  
 FIG. 24 is a rear, clasp-opened, side elevational view thereof;  
 FIG. 25 is a right, clasp-opened, side elevational view thereof;  
 FIG. 26 is a left, clasp-opened, side elevational view thereof;  
 FIG. 27 is a top, clasp-opened, plan view thereof;  
 FIG. 28 is a bottom, clasp-opened, plan view thereof;  
 FIG. 29 is a top, front, clasp-closed, perspective view of a third embodiment of a jewelry clasp showing my design therefor;  
 FIG. 30 is a front, clasp-closed, side elevational view thereof;  
 FIG. 31 is a rear, clasp-closed, side elevational view thereof;  
 FIG. 32 is a right, clasp-closed, side elevational view thereof;  
 FIG. 33 is a left, clasp-closed, side elevational view thereof;  
 FIG. 34 is a top, clasp-closed, plan view thereof;  
 FIG. 35 is a bottom, clasp-closed, plan view thereof;  
 FIG. 36 is a top, front, clasp-opened, perspective view thereof;  
 FIG. 37 is a front, clasp-opened, side elevational view thereof;  
 FIG. 38 is a rear, clasp-opened, side elevational view thereof;  
 FIG. 39 is a right, clasp-opened, side elevational view thereof;  
 FIG. 40 is a left, clasp-opened, side elevational view thereof;  
 FIG. 41 is a top, clasp-opened, plan view thereof;  
 FIG. 42 is a bottom, clasp-opened, plan view thereof;  
 FIG. 43 is a top, front, clasp-closed, perspective view of a fourth embodiment of a jewelry clasp showing my design therefor;  
 FIG. 44 is a front, clasp-closed, side elevational view thereof;  
 FIG. 45 is a rear, clasp-closed, side elevational view thereof;  
 FIG. 46 is a right, clasp-closed, side elevational view thereof;  
 FIG. 47 is a left, clasp-closed, side elevational view thereof;  
 FIG. 48 is a top, clasp-closed, plan view thereof;  
 FIG. 49 is a bottom, clasp-closed, plan view thereof;  
 FIG. 50 is a top, front, clasp-opened, perspective view thereof;  
 FIG. 51 is a front, clasp-opened, side elevational view thereof;  
 FIG. 52 is a rear, clasp-opened, side elevational view thereof;  
 FIG. 53 is a right, clasp-opened, side elevational view thereof;  
 FIG. 54 is a left, clasp-opened, side elevational view thereof;  
 FIG. 55 is a top, clasp-opened, plan view thereof; and,  
 FIG. 56 is a bottom, clasp-opened, plan view thereof.  
 The broken lines in FIGS. 15-28 and FIGS. 43-56 depict portions of the jewelry clasp that form no part of the embodiments in which they are shown, and the broken lines form no part of the claimed design.

1 Claim, 40 Drawing Sheets

(58) **Field of Classification Search**

CPC .... A44C 1/00; A44C 5/02; A44C 5/18; A44C 5/0007; A44C 5/0038; A44C 5/0046; A44C 5/0084; A44C 5/0092; A44C 5/2033; A44C 9/0046; A44C 25/00; A44C 25/001; A44C 25/007; A44C 3/008; A44C 5/20; A44C 5/1014; A44C 5/2047; A44C 11/00; A44C 15/005; Y10T 24/44538; Y10T 24/45016; F16B 45/02

See application file for complete search history.

(56) **References Cited**

U.S. PATENT DOCUMENTS

1,141,316	A *	6/1915	Cockrell	.....	H02G 7/10 24/339
1,209,615	A *	12/1916	Obsboum	.....	A44C 5/2014 24/598.2
1,637,699	A *	8/1927	Lauterbach	.....	A44C 5/2033 24/574.1
2,462,425	A *	2/1949	Pratt	.....	A44C 11/005 63/3
D200,490	S *	3/1965	Berzner	.....	D11/87
D386,108	S *	11/1997	Montaquila	.....	A44C 5/2009 D11/88
D704,591	S *	5/2014	Adams	.....	D11/87
D726,060	S *	4/2015	Wood	.....	D11/79
D726,061	S *	4/2015	Wood	.....	D11/54
D726,572	S *	4/2015	Walters	.....	H02G 7/10 D14/344
9,080,595	B1 *	7/2015	Mitchell	.....	A44C 5/2038 D11/54
D832,130	S *	10/2018	Bostic	.....	D11/87
D897,881	S *	10/2020	Ashton	.....	D11/87
2008/0040899	A1 *	2/2008	Tan	.....	A44C 5/2019 63/3.1
2009/0301134	A1 *	12/2009	Kim-Araneo	.....	A44C 5/2009 63/3.1
2015/0359304	A1 *	12/2015	Thomas	.....	A44C 5/2014 24/598.2

OTHER PUBLICATIONS

Pendant Bail. Online [website]. Amazon, Jul. 29, 2017 [retrieved on Aug. 25, 2022]. Retrieved from the internet: <[https://www.amazon.com/Sterling-Enhancer-Shortener-Pendant-Connector/dp/B074CTDXRH/ref=sr\\_1\\_52](https://www.amazon.com/Sterling-Enhancer-Shortener-Pendant-Connector/dp/B074CTDXRH/ref=sr_1_52)>. (Year: 2017).\*

Shaw-Ellis, Daisy. Lindsey Boyd, Cofounder of The Laundress, Launches a Charming Fine-Jewelry Brand. Online [website]. Vogue, Dec. 14, 2020 [retrieved on Aug. 12, 2022]. Retrieved from the internet: <<https://www.vogue.com/article/rondel-jewelry-launch>>. (Year: 2020).\*

Abeille Finds. Online [website]. Instagram, posted online by user @abeillefinds on Aug. 8, 2020 [retrieved on Aug. 22, 2022]. Retrieved from the internet: <<https://www.instagram.com/p/CDoQW80Fbjg/>>. (Year: 2020).\*

Three Sisters Jewelry Design. Online [website]. Instagram, posted online by user @threesistersjewelry on Jul. 27, 2020 [retrieved on Aug. 22, 2022]. Retrieved from the internet: <<https://www.instagram.com/p/CDKuX-GoYCO/>>. (Year: 2020).\*

Oval Charm Clip. Online [website]. Etsy, publication date unknown [retrieved on Aug. 25, 2022]. Retrieved from the internet: <<https://www.etsy.com/listing/1042654758/oval-charm-clip-14k-18k-solid-gold-charm>>. (Year: 2022).\*

\* cited by examiner

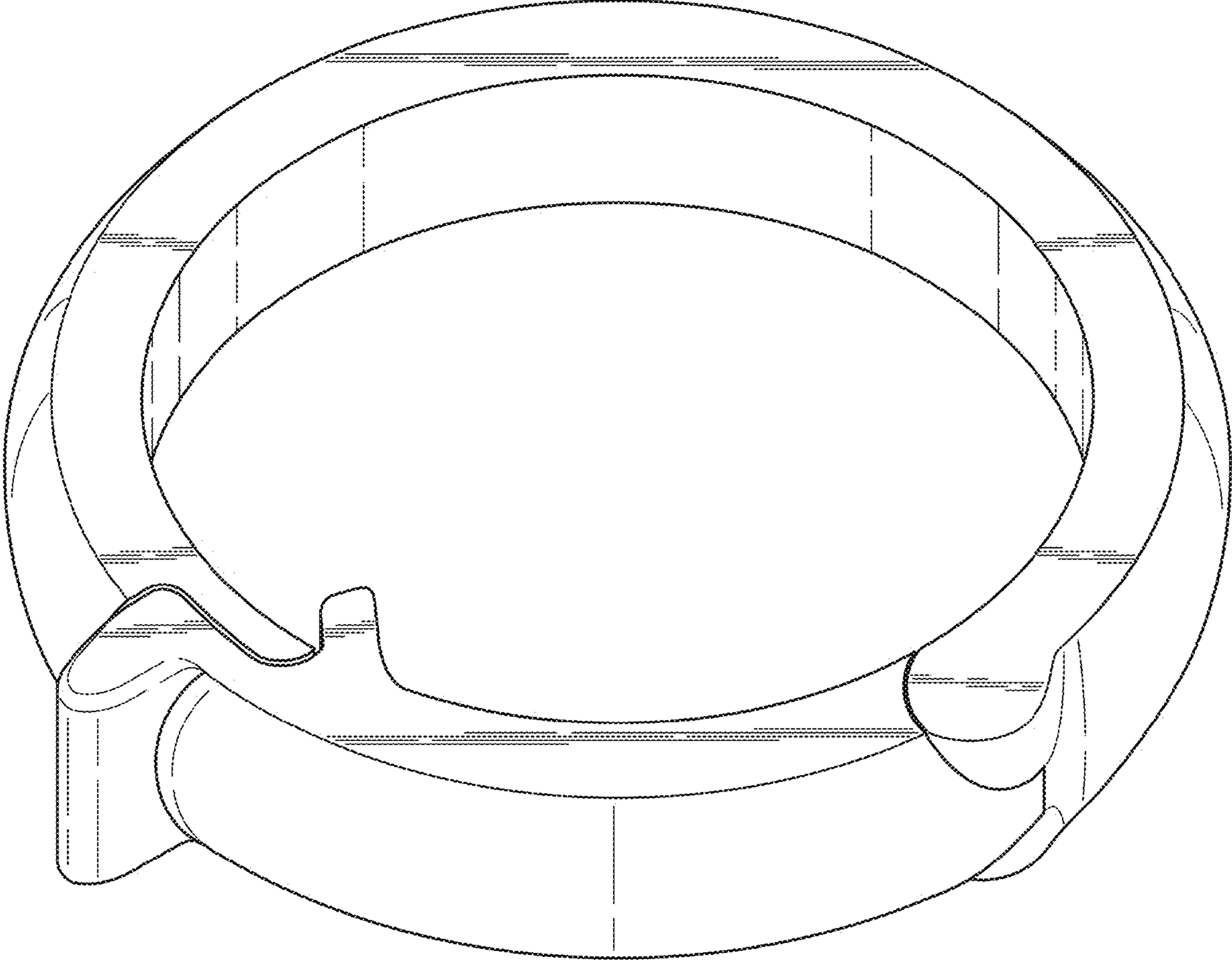

FIG. 1

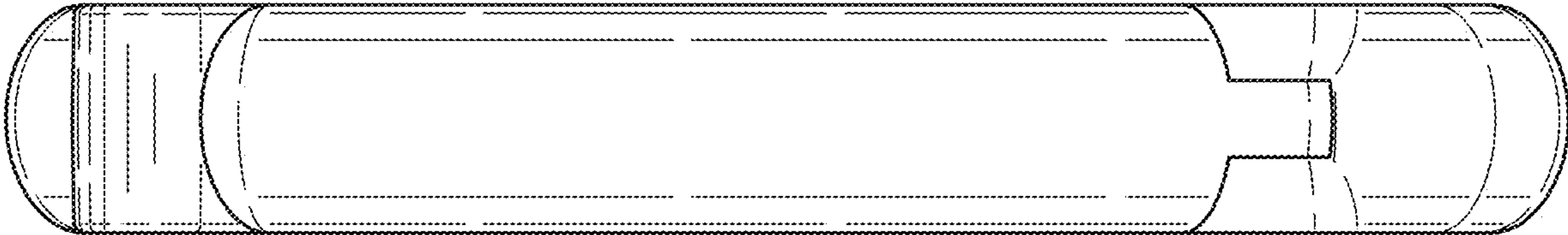

FIG. 2

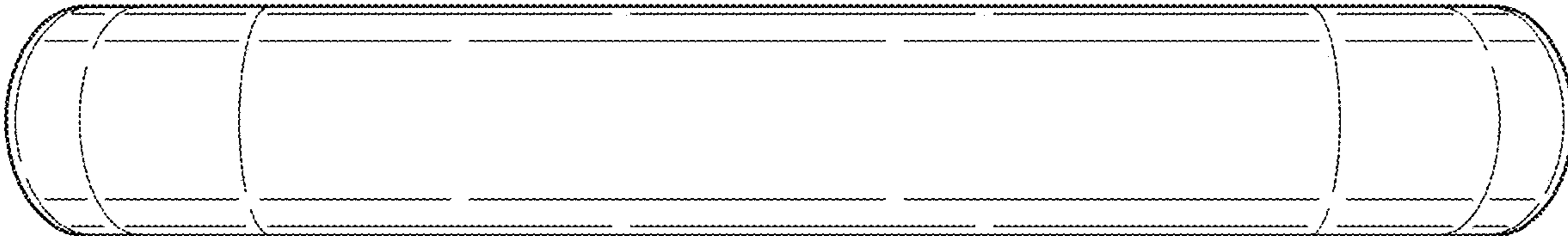

FIG. 3

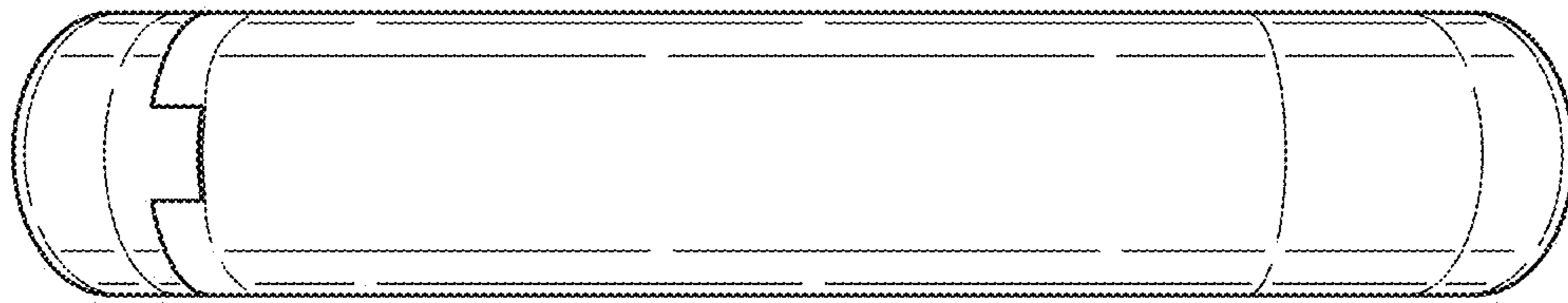

FIG. 4

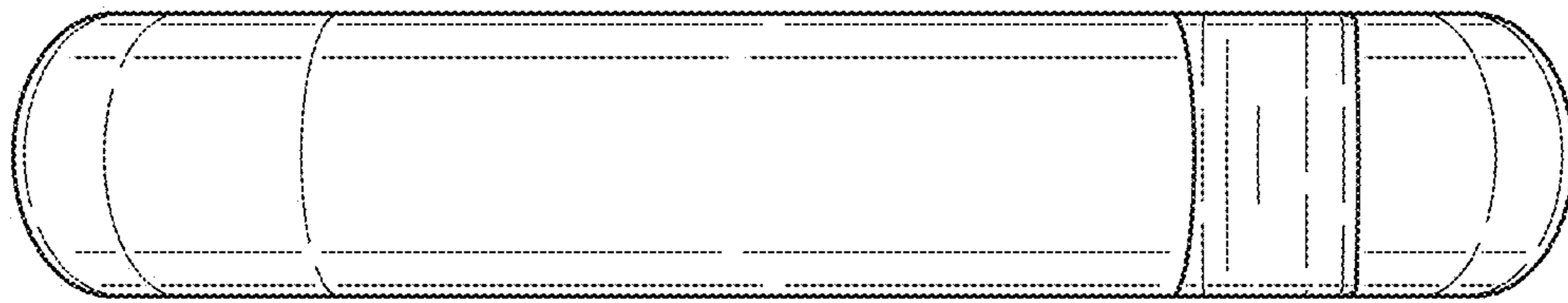

FIG. 5

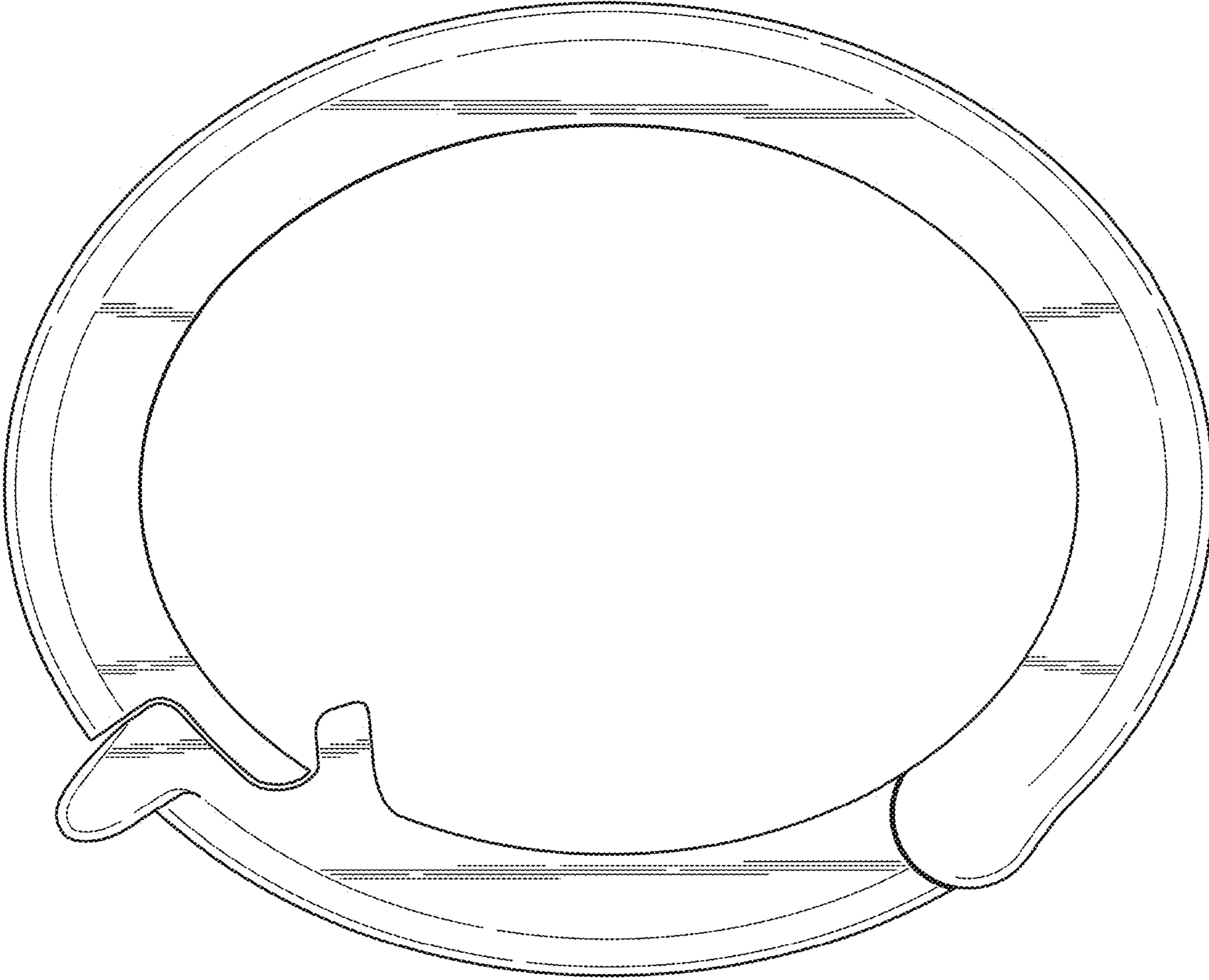

FIG. 6

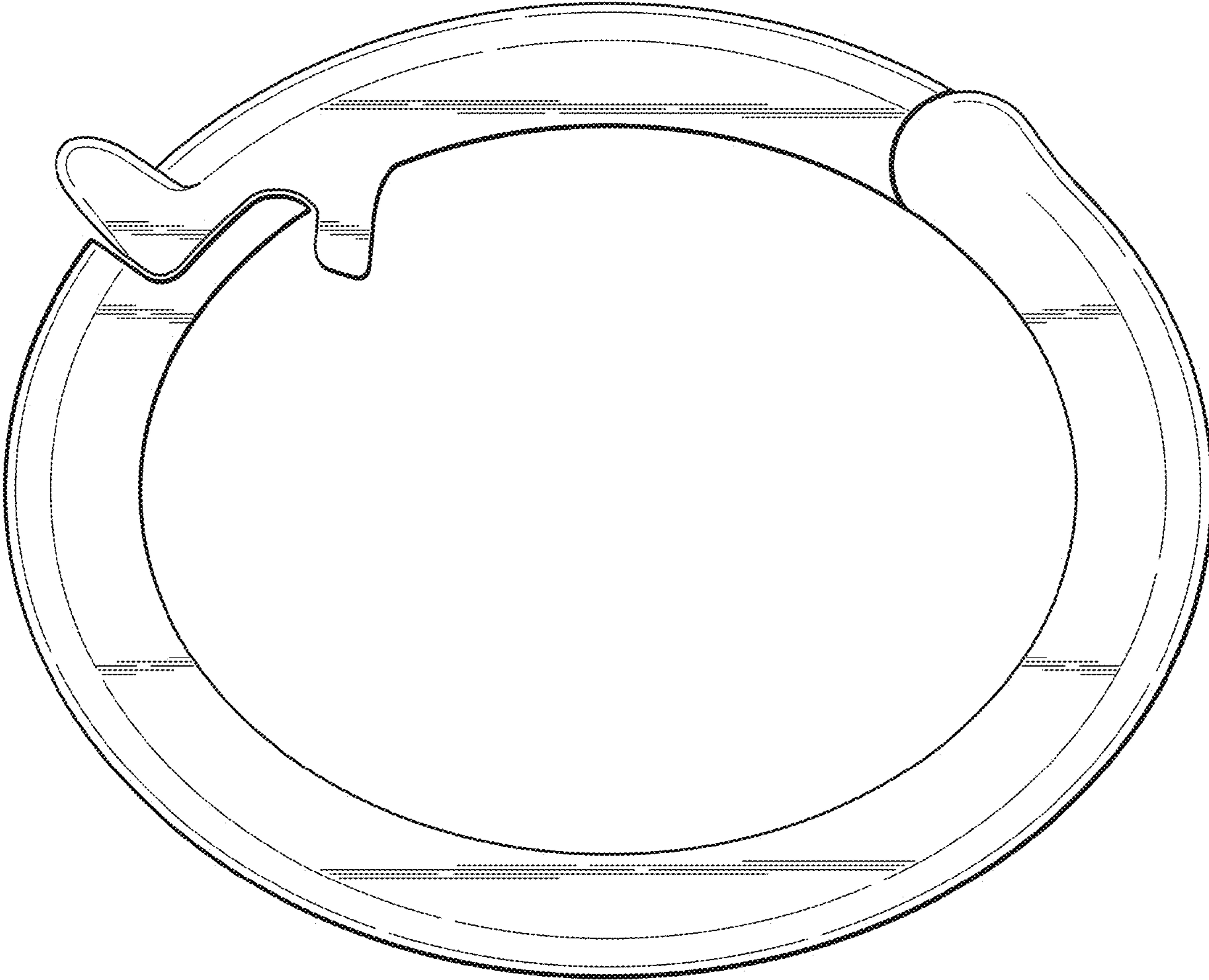

FIG. 7

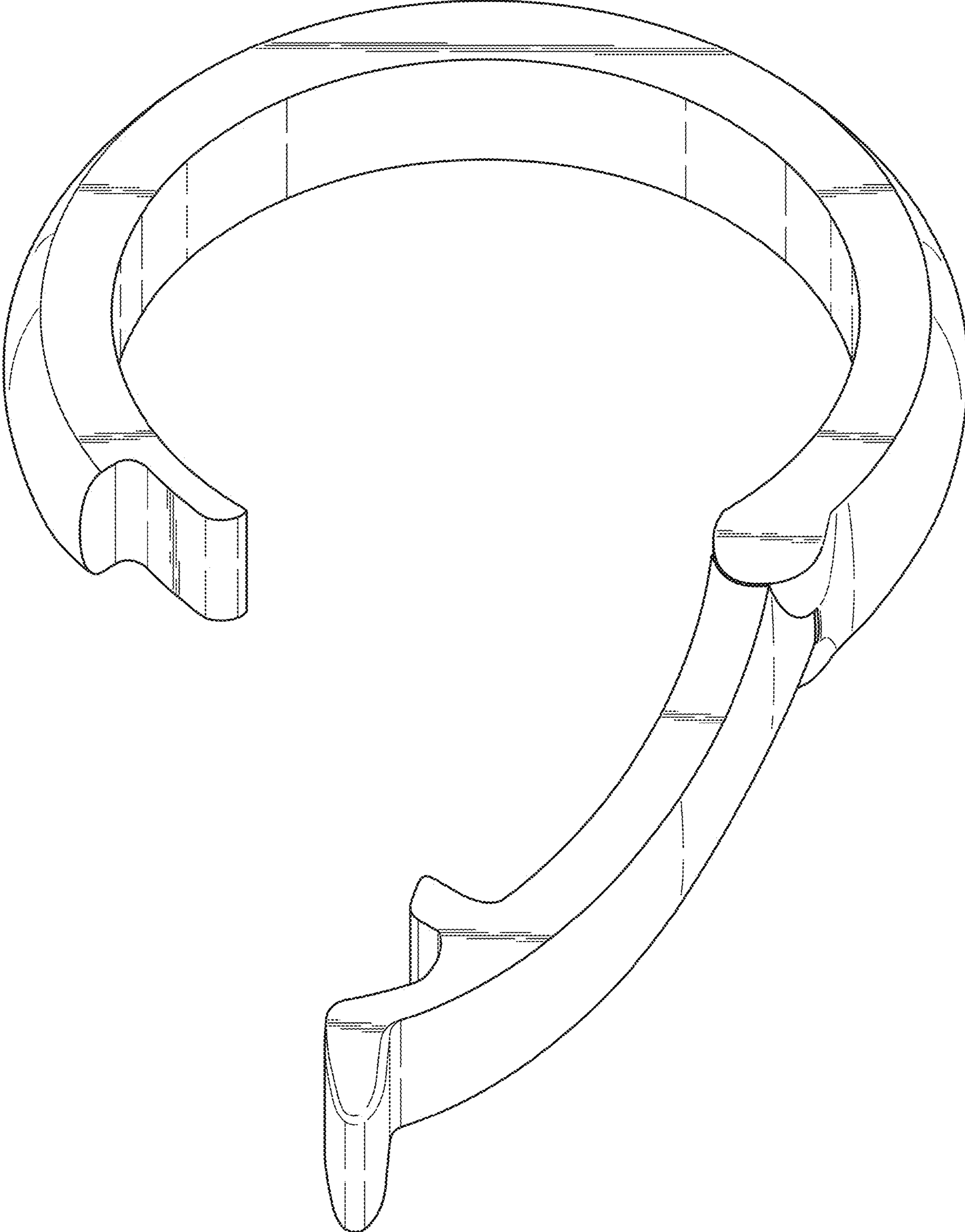

FIG. 8



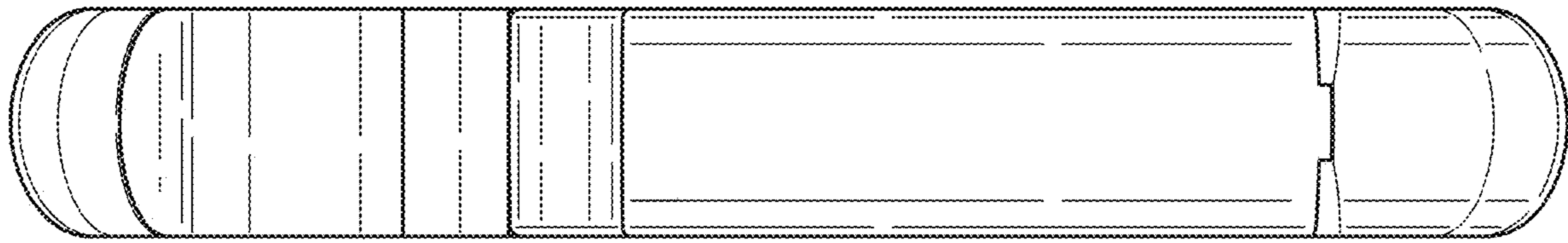

FIG. 9

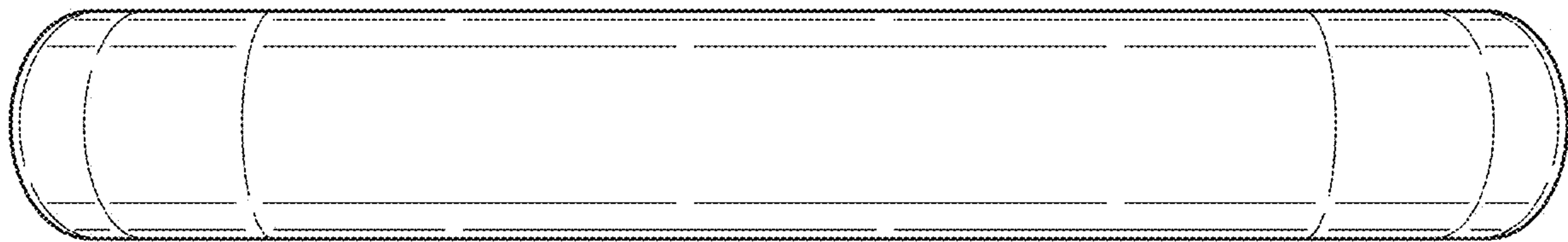

FIG. 10

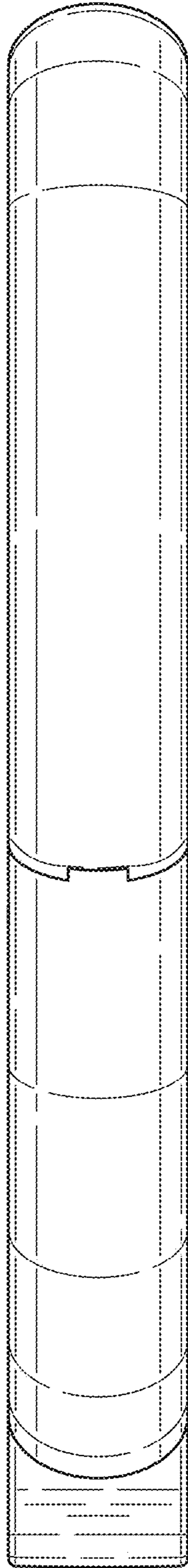

FIG. 11

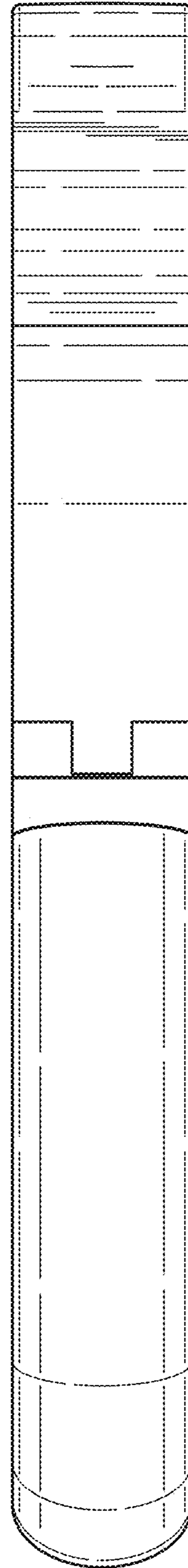

FIG. 12

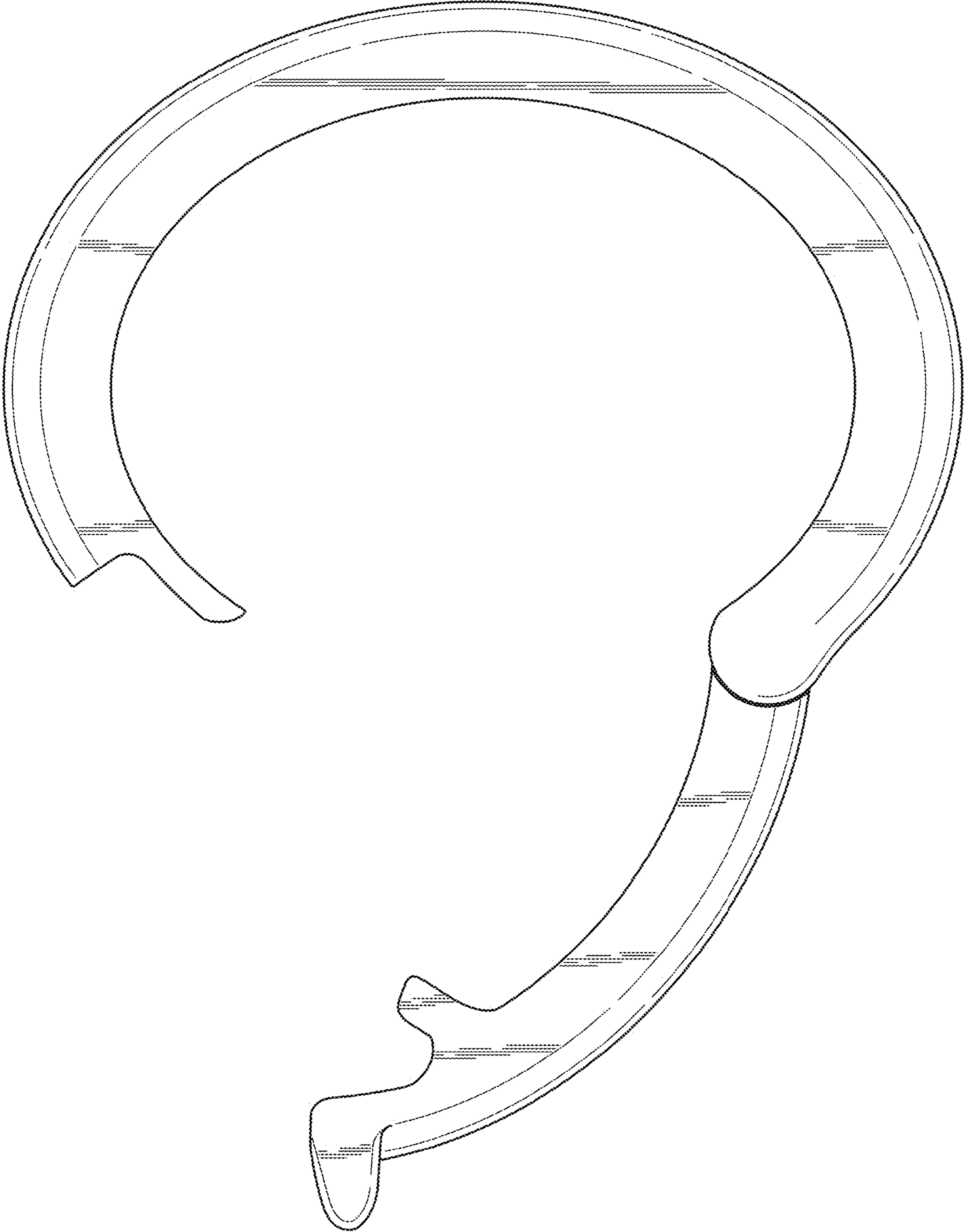

FIG. 13

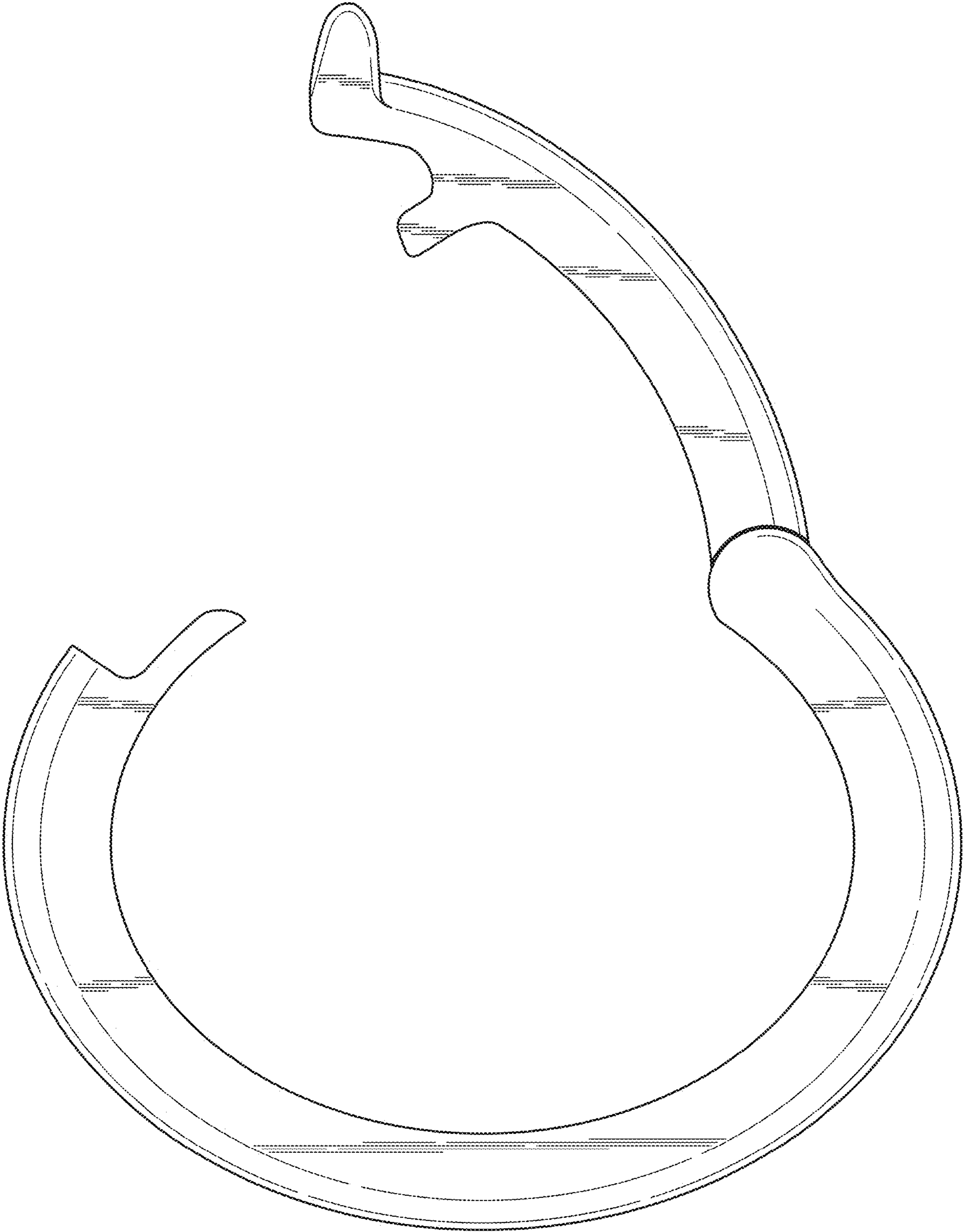

FIG. 14

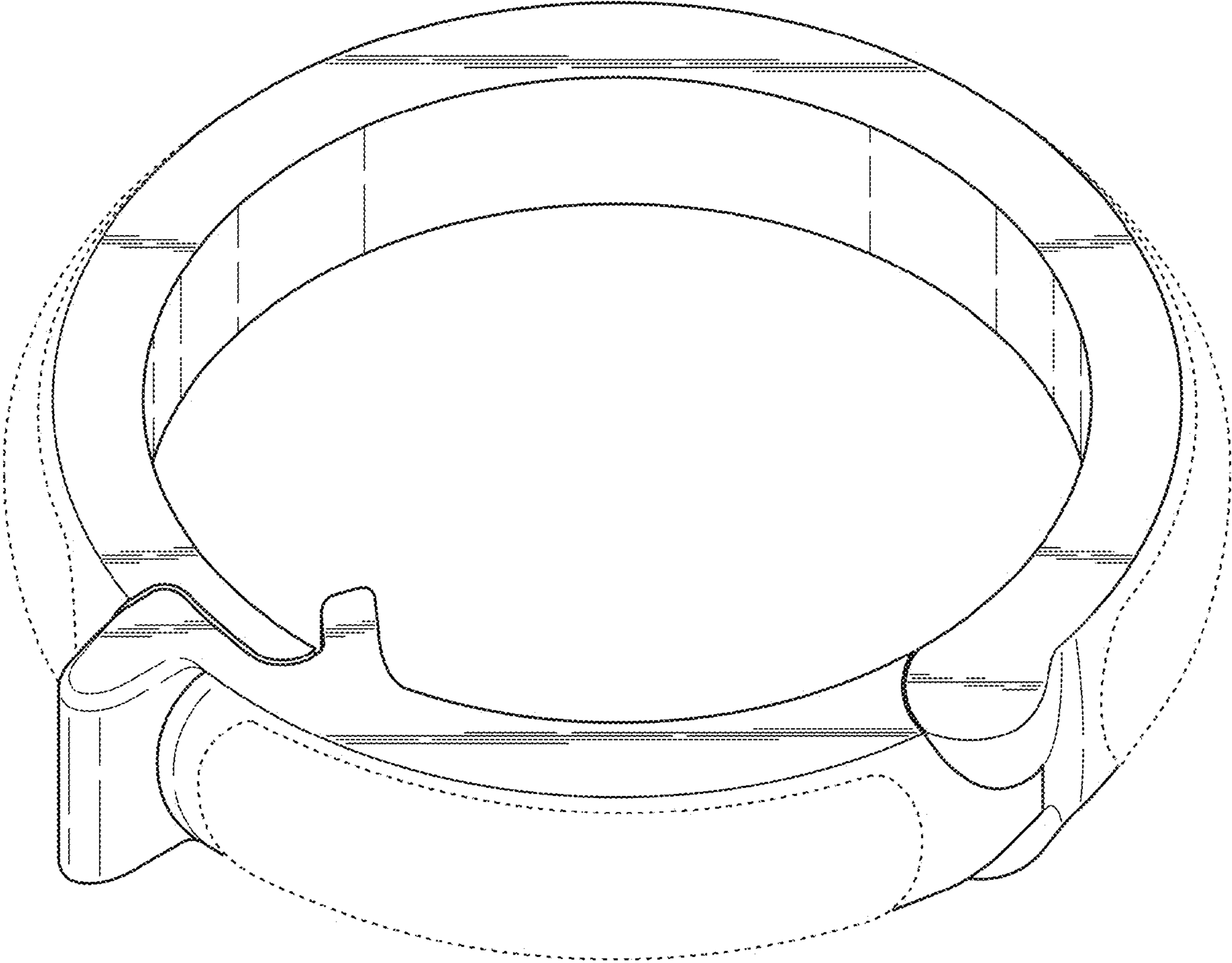

FIG. 15



FIG. 16

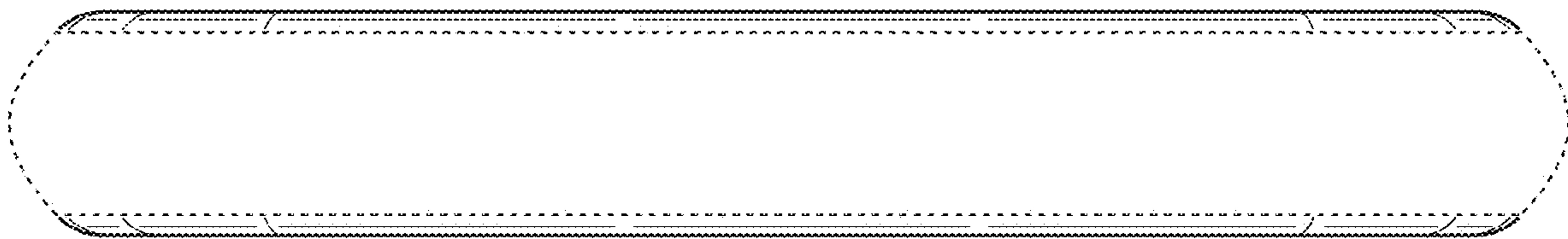

FIG. 17

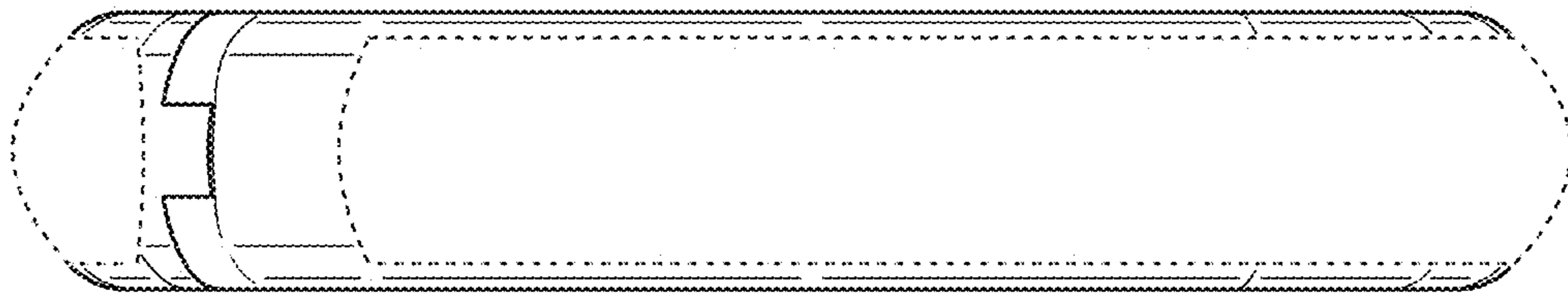

FIG. 18

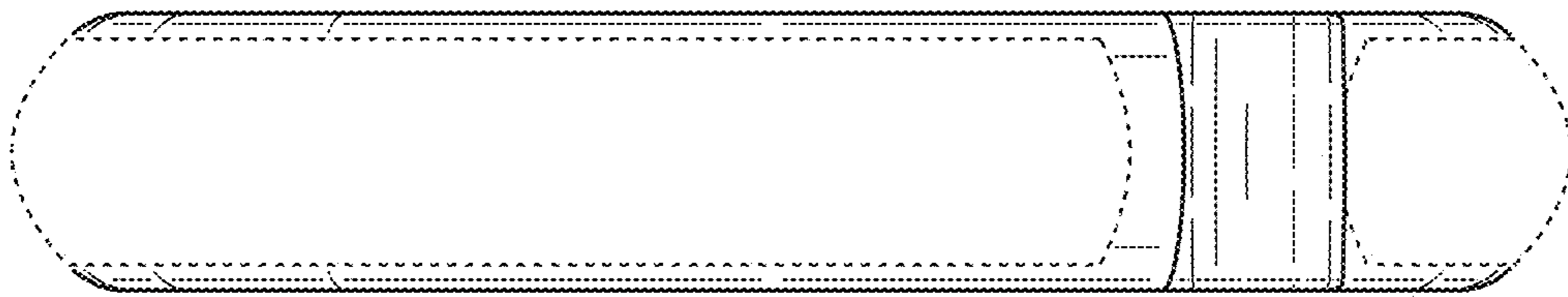

FIG. 19

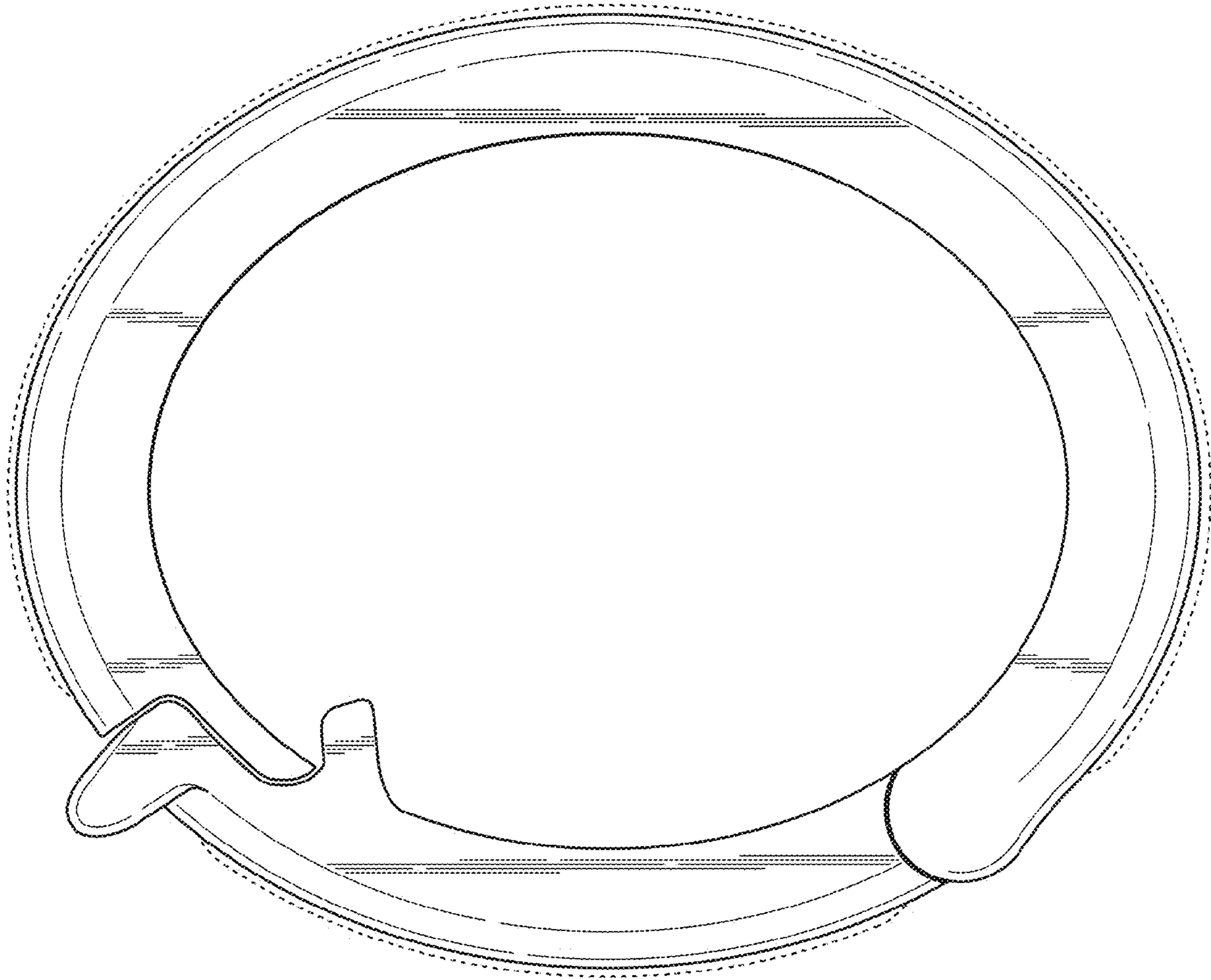

FIG. 20



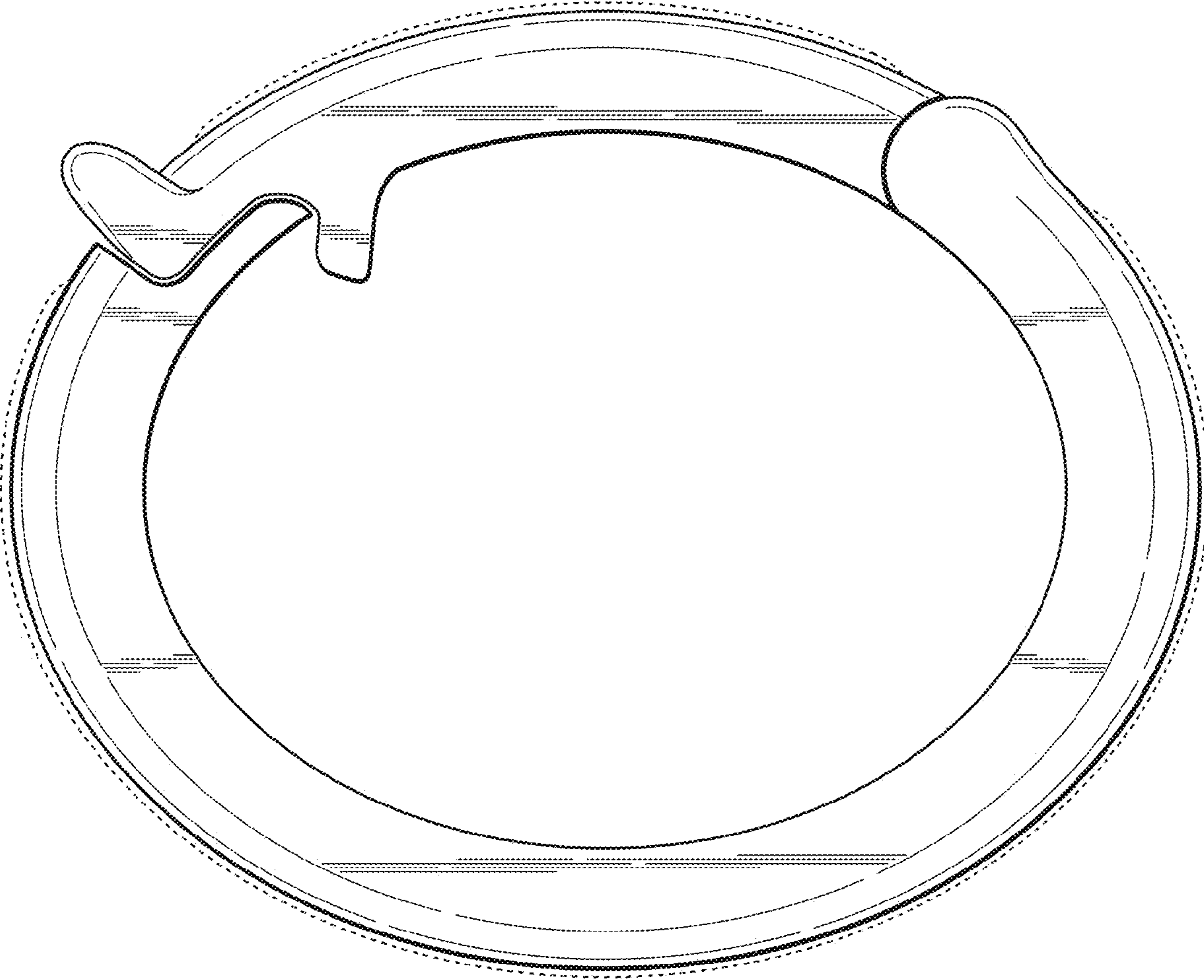

FIG. 21

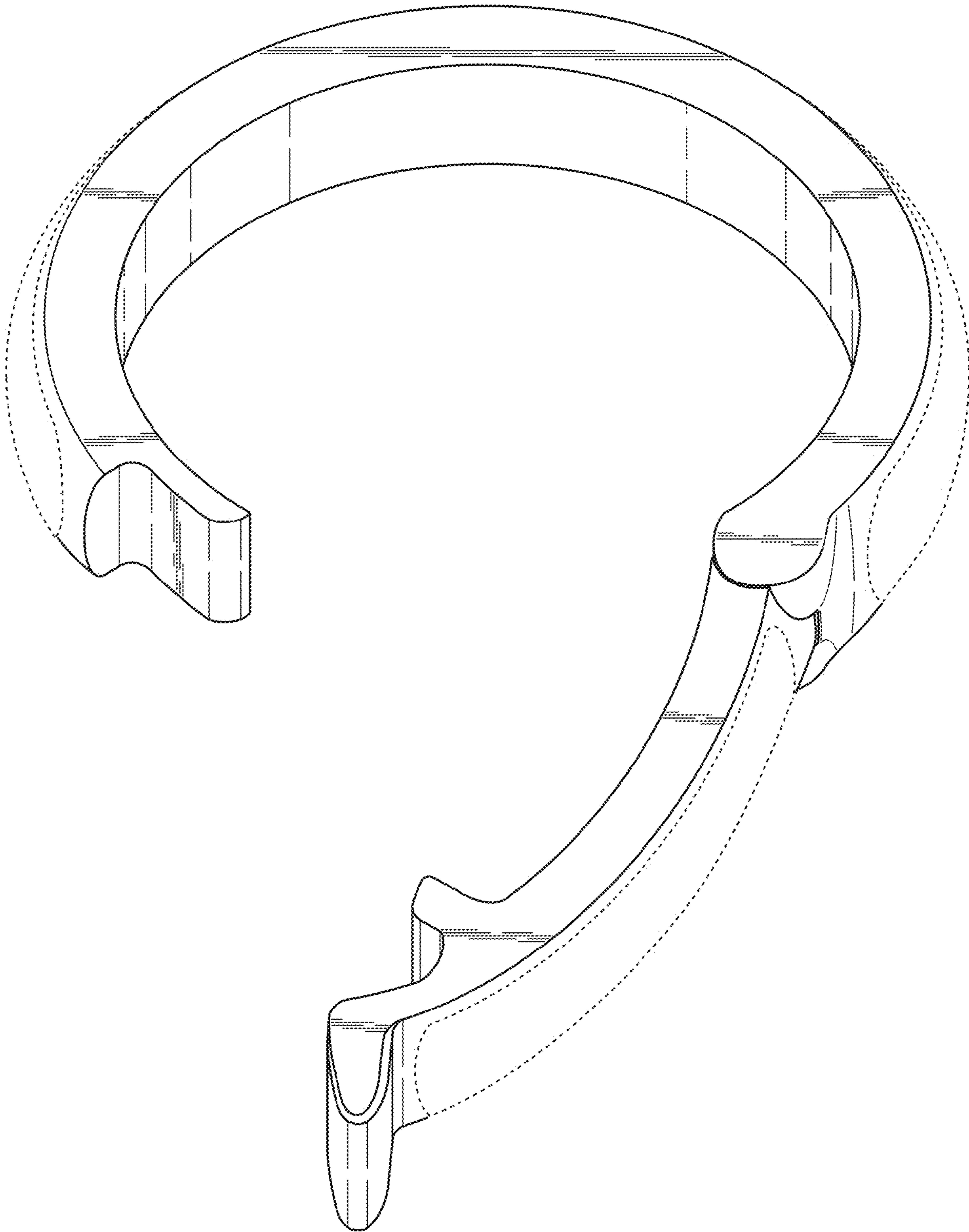

FIG. 22

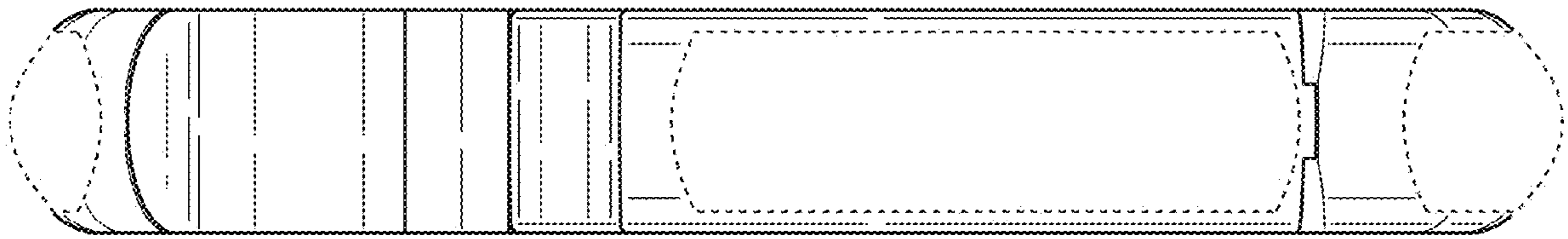

FIG. 23

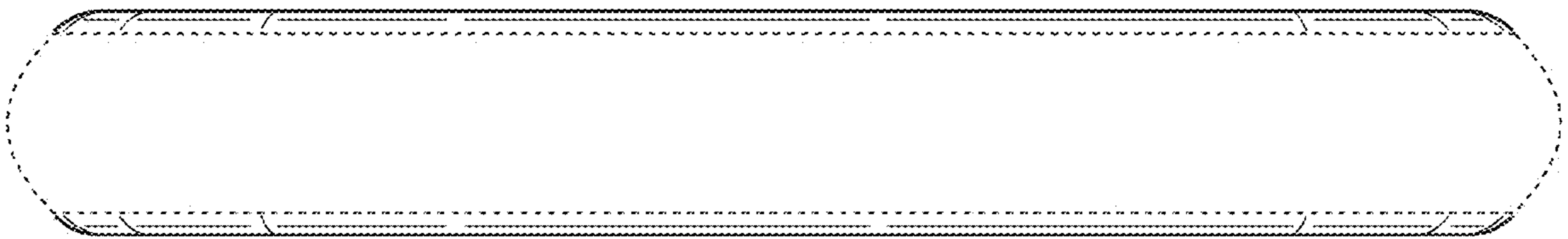

FIG. 24

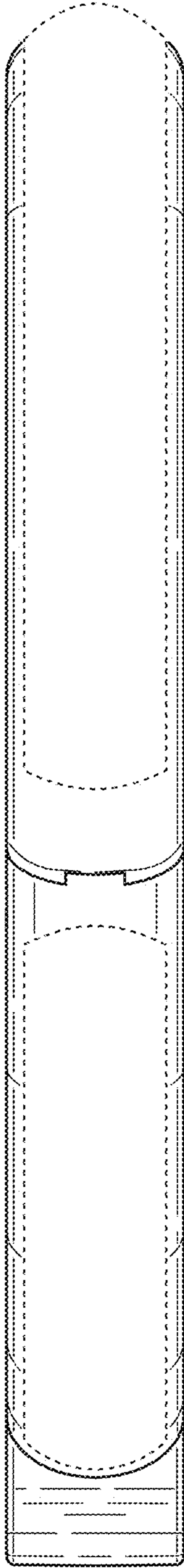

FIG. 25

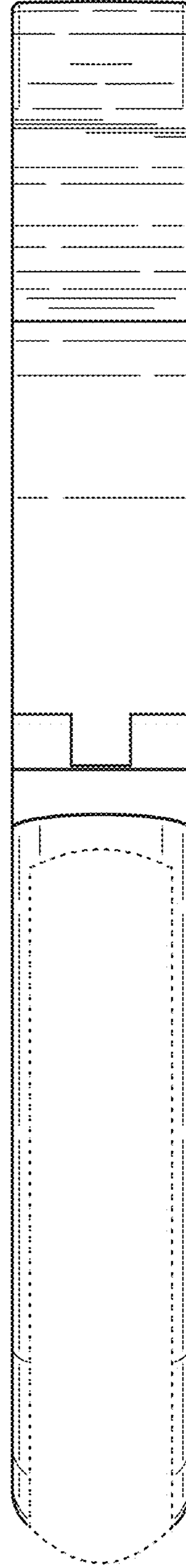

FIG. 26

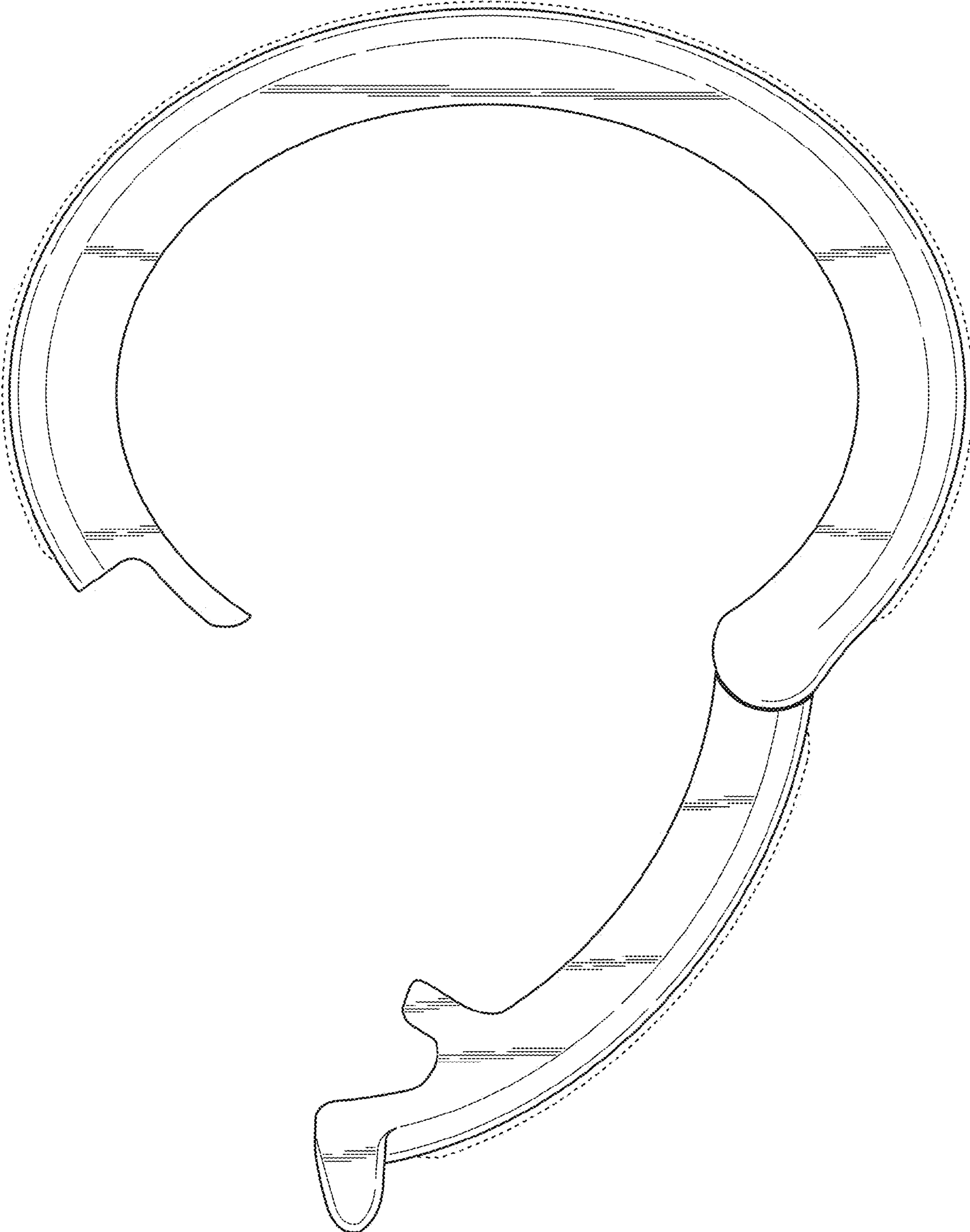

FIG. 27

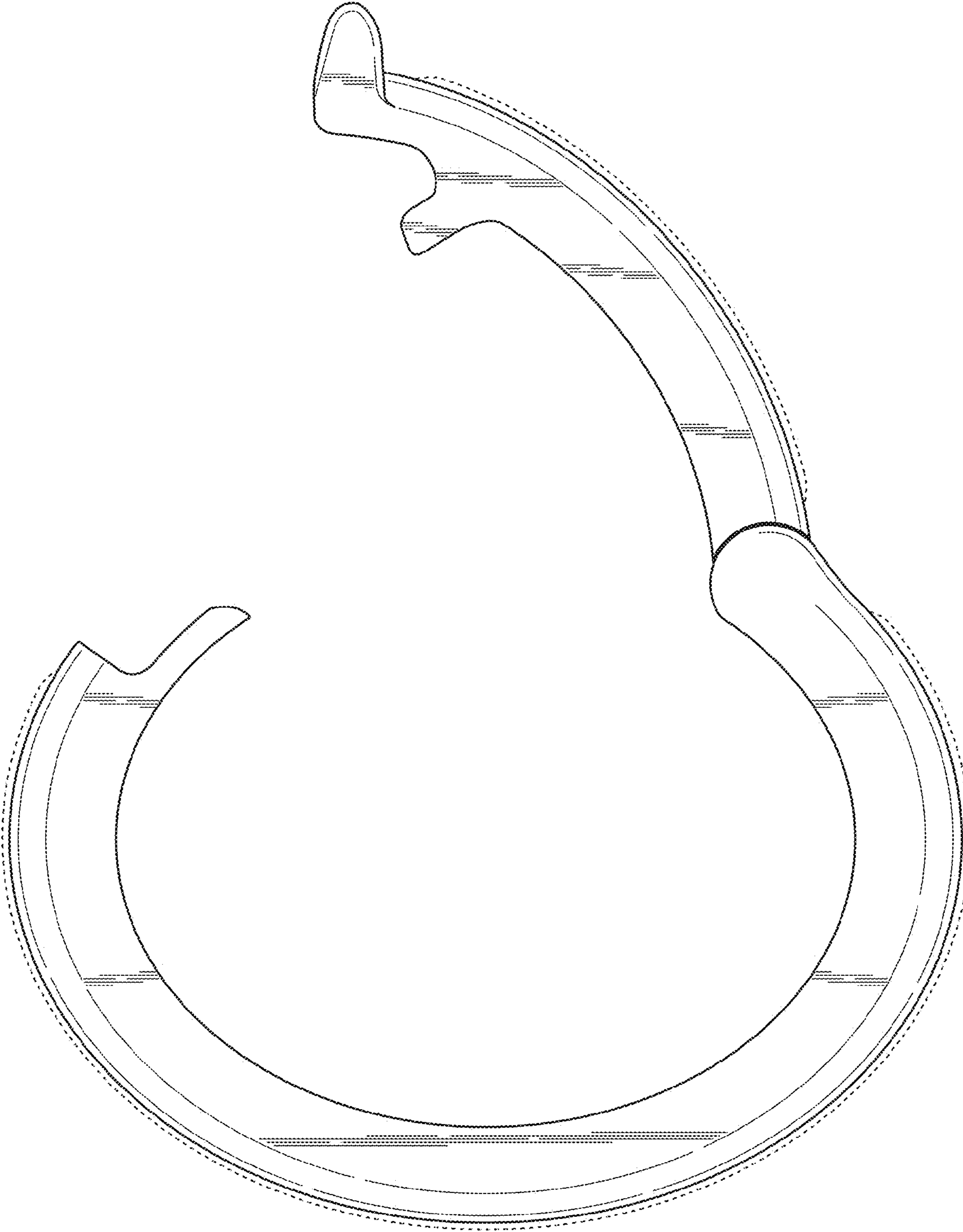

FIG. 28

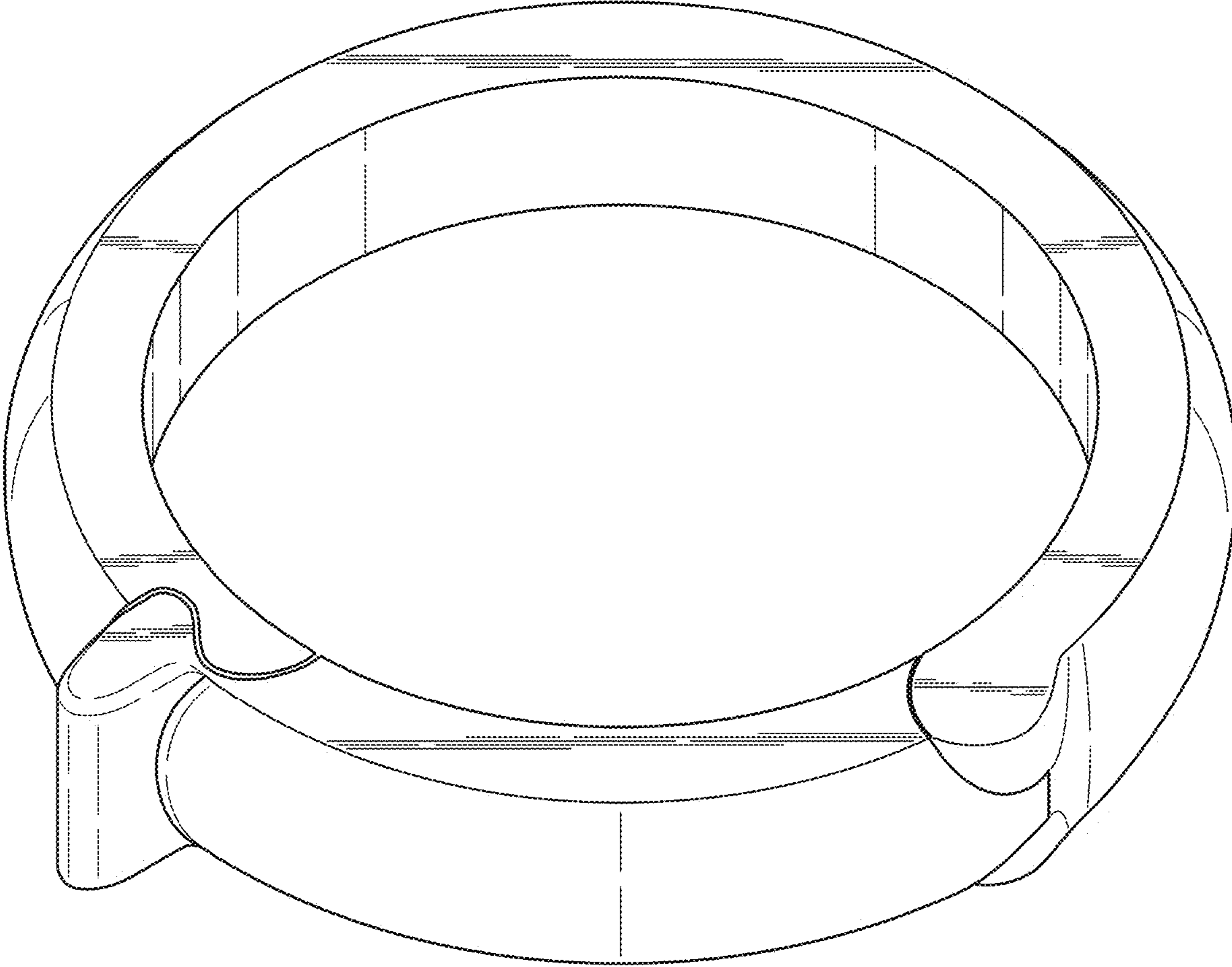

FIG. 29

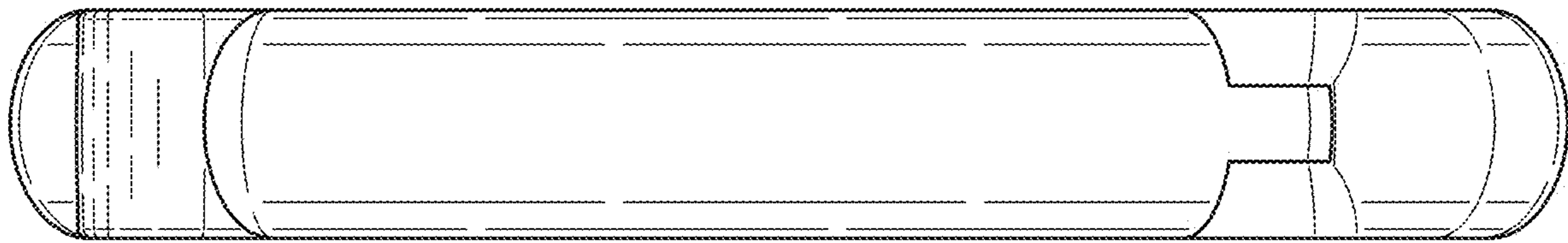

FIG. 30

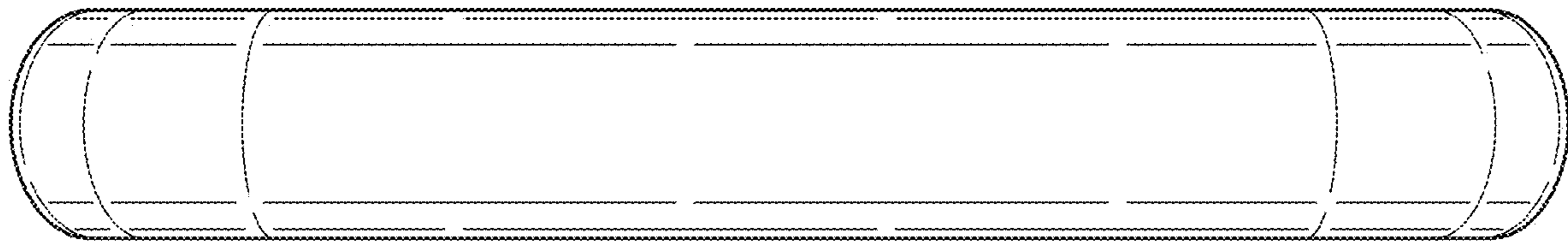

FIG. 31



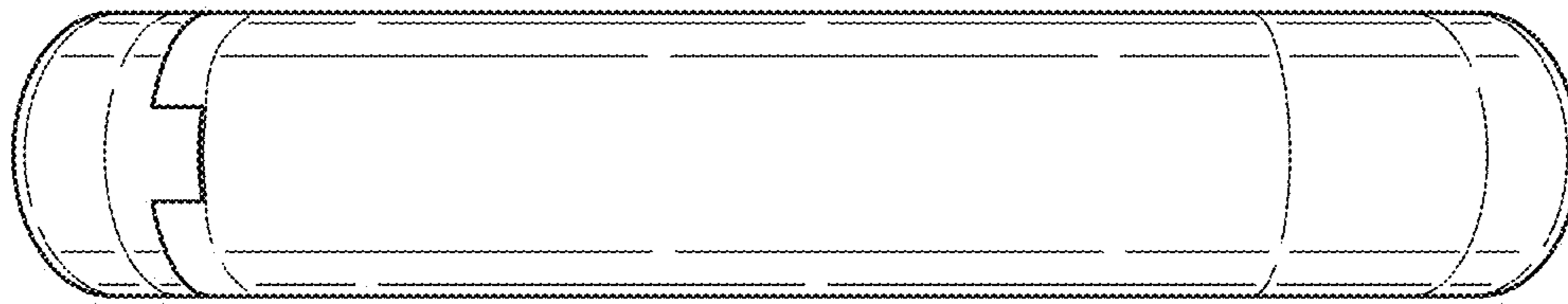

FIG. 32

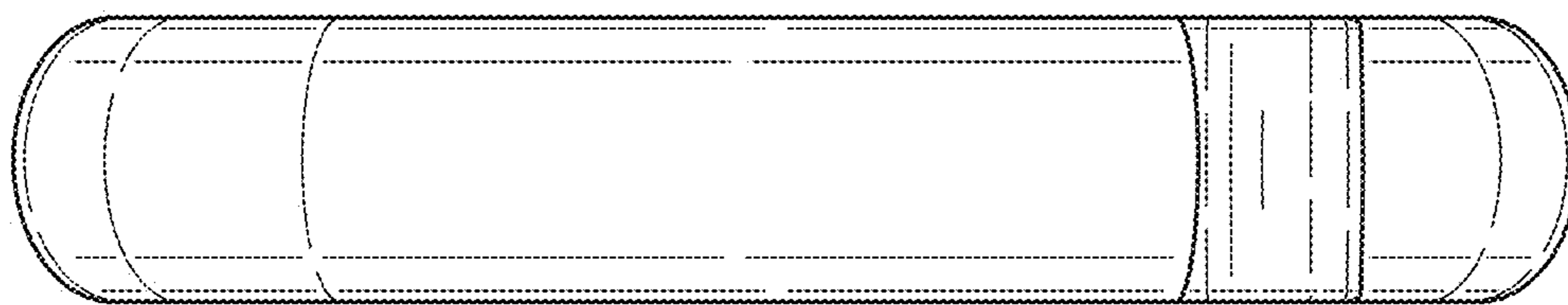

FIG. 33

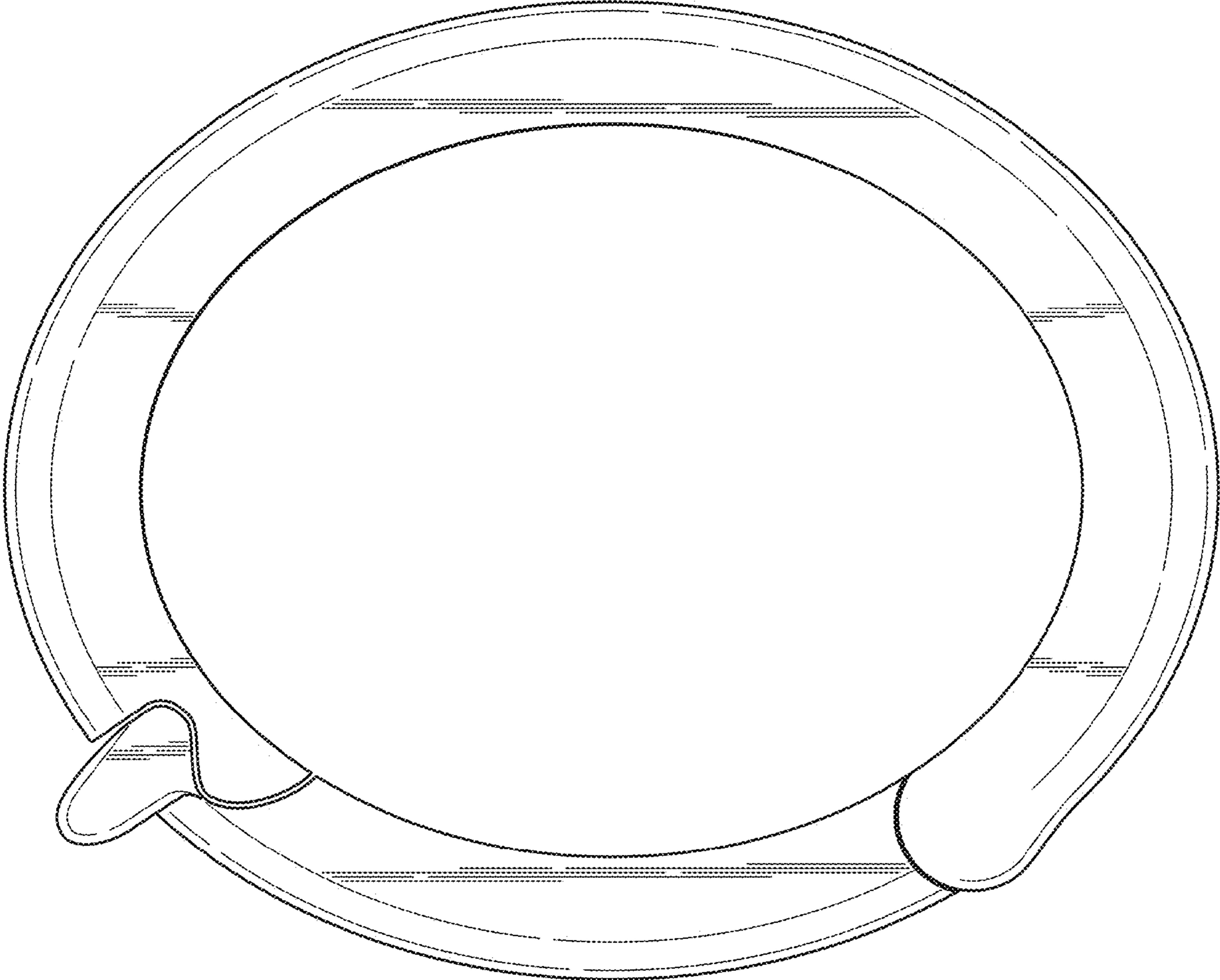

FIG. 34

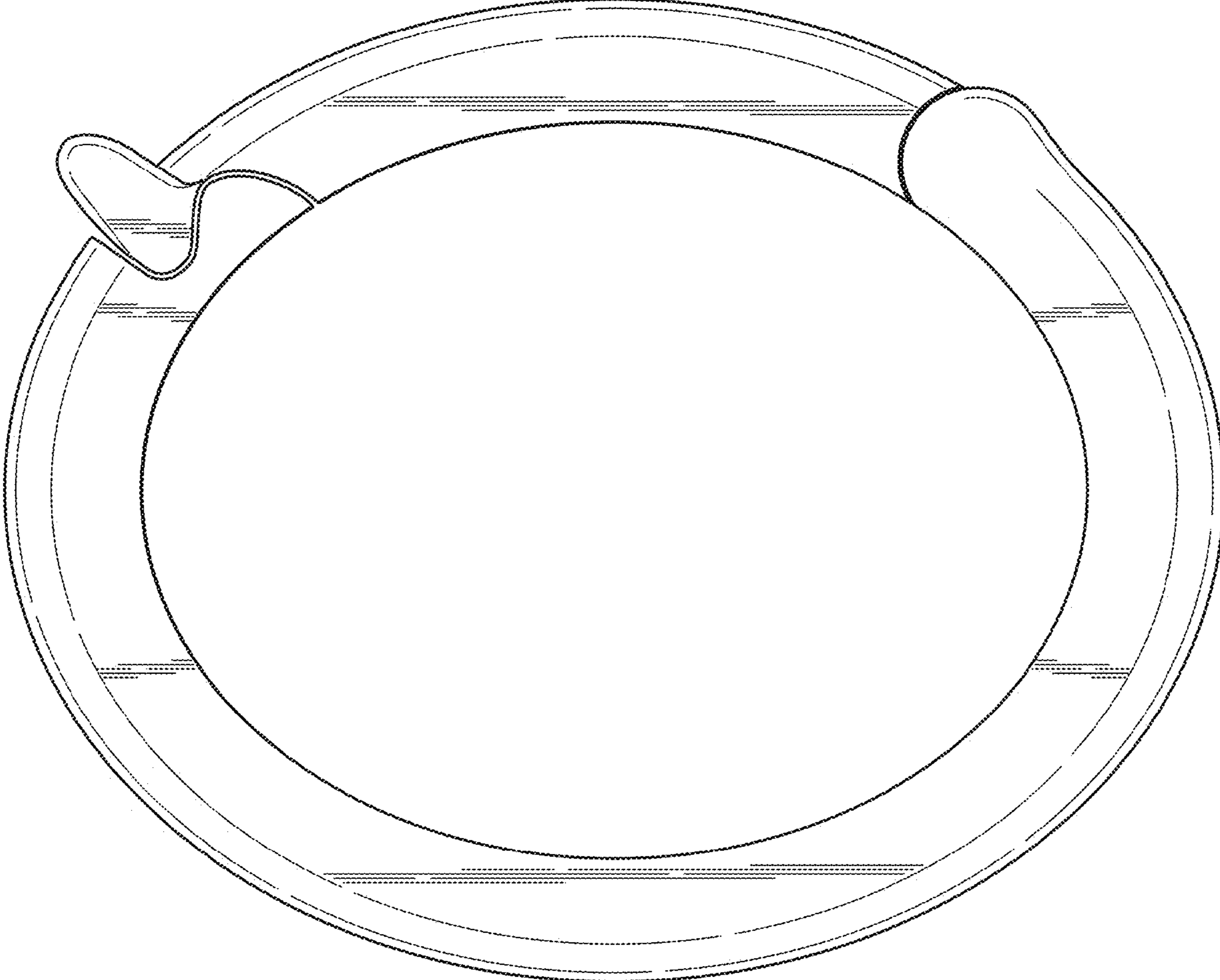

FIG. 35

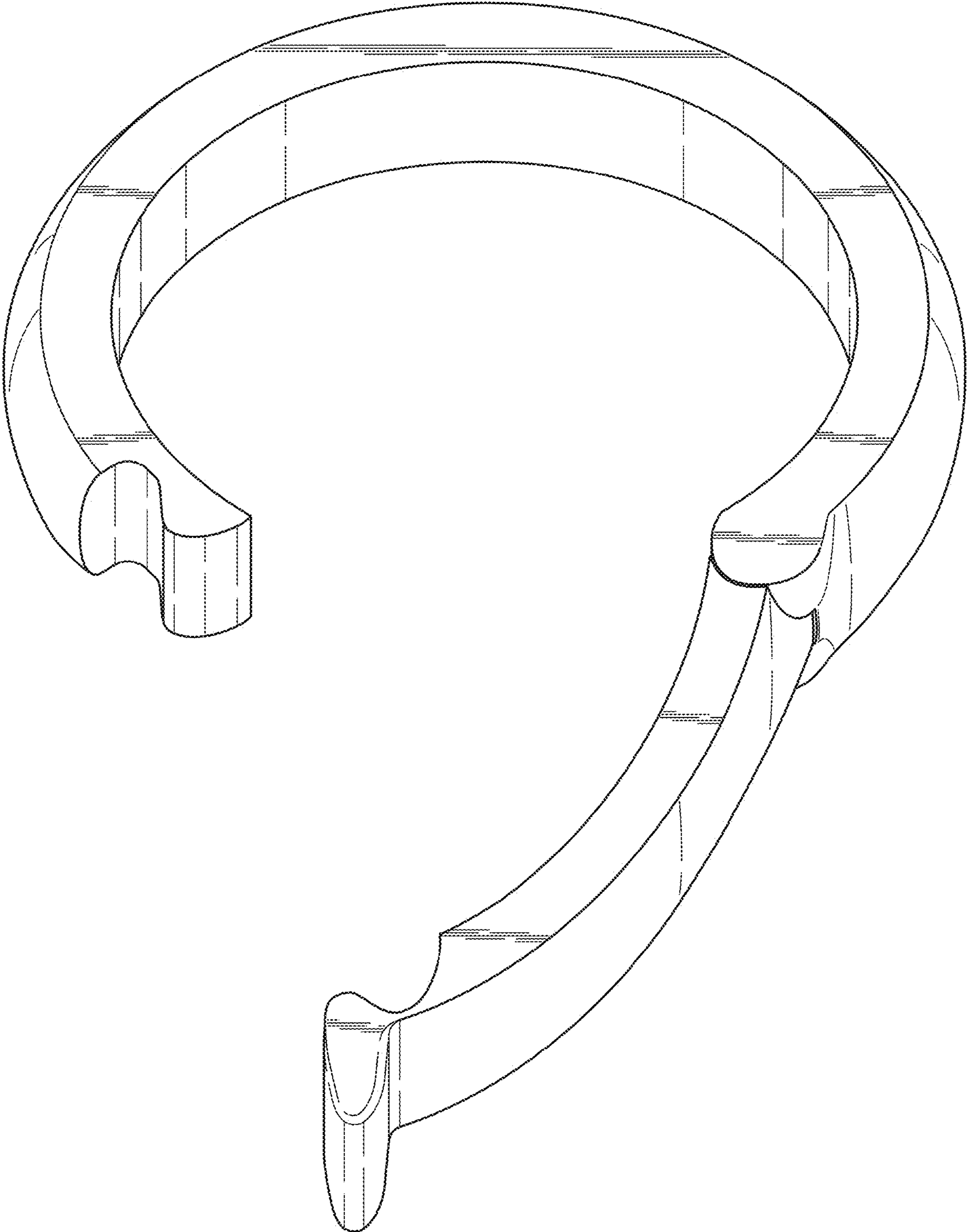

FIG. 36

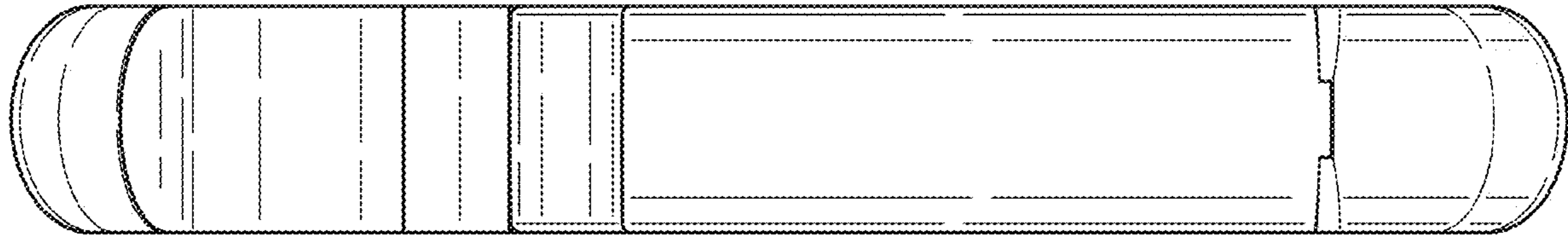

FIG. 37

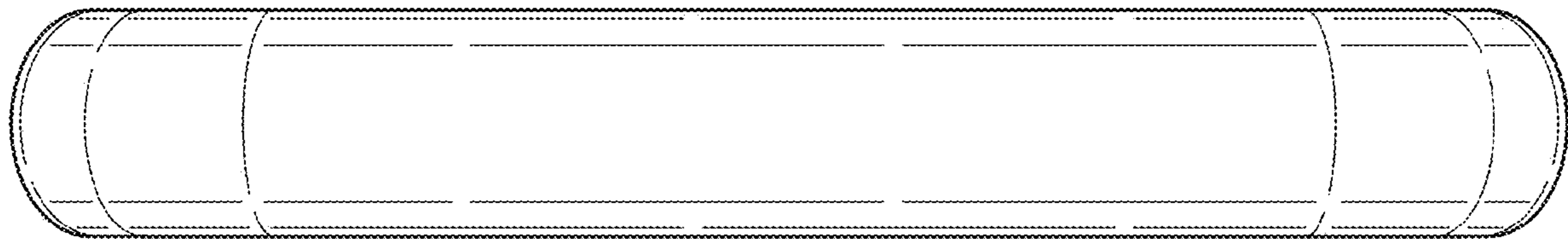

FIG. 38

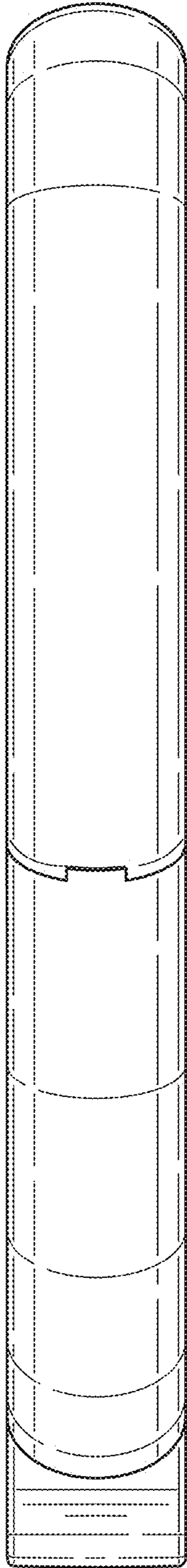

FIG. 39

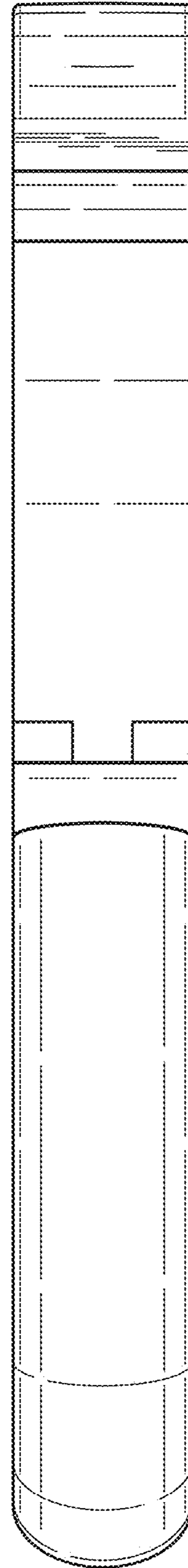

FIG. 40

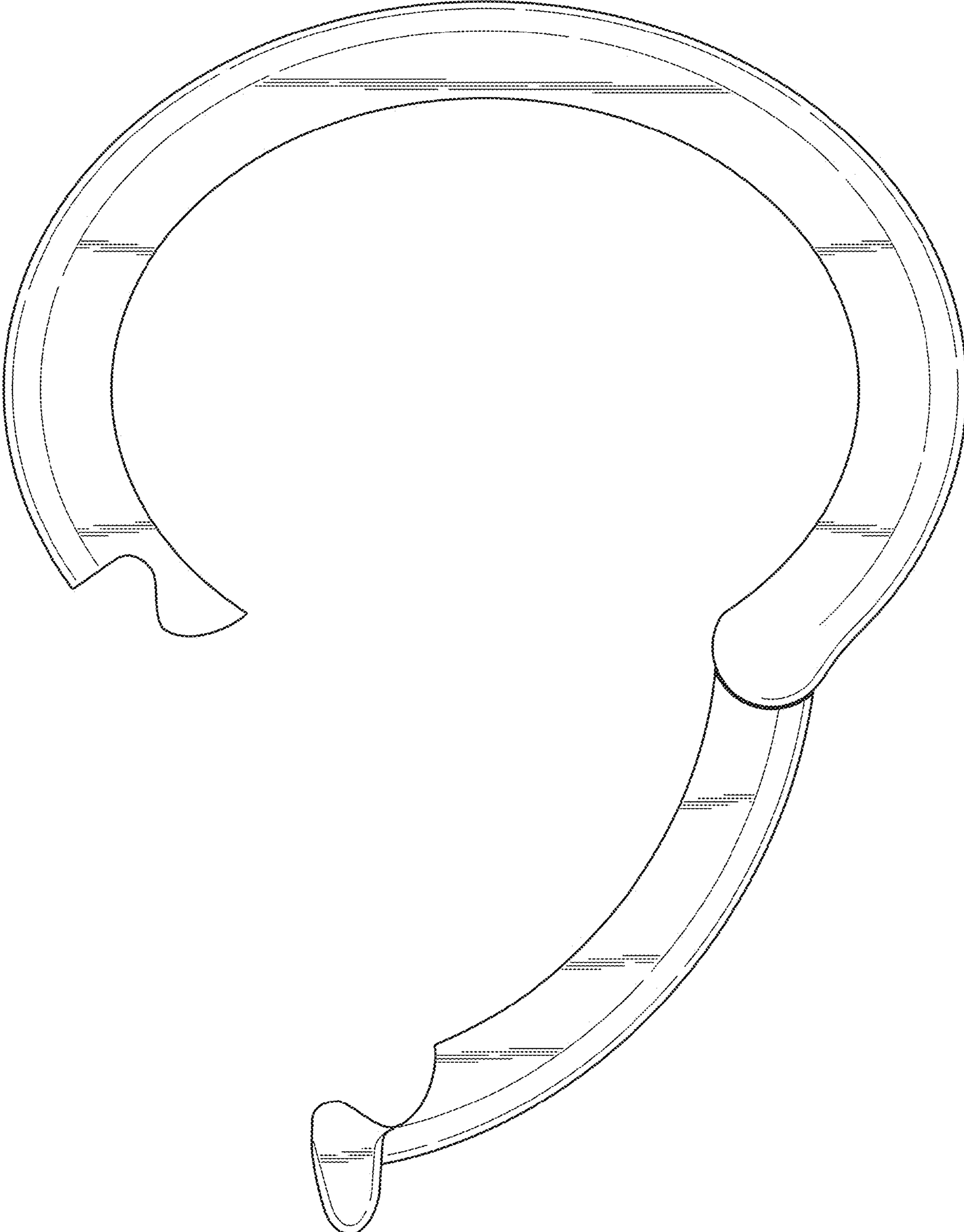

FIG. 41

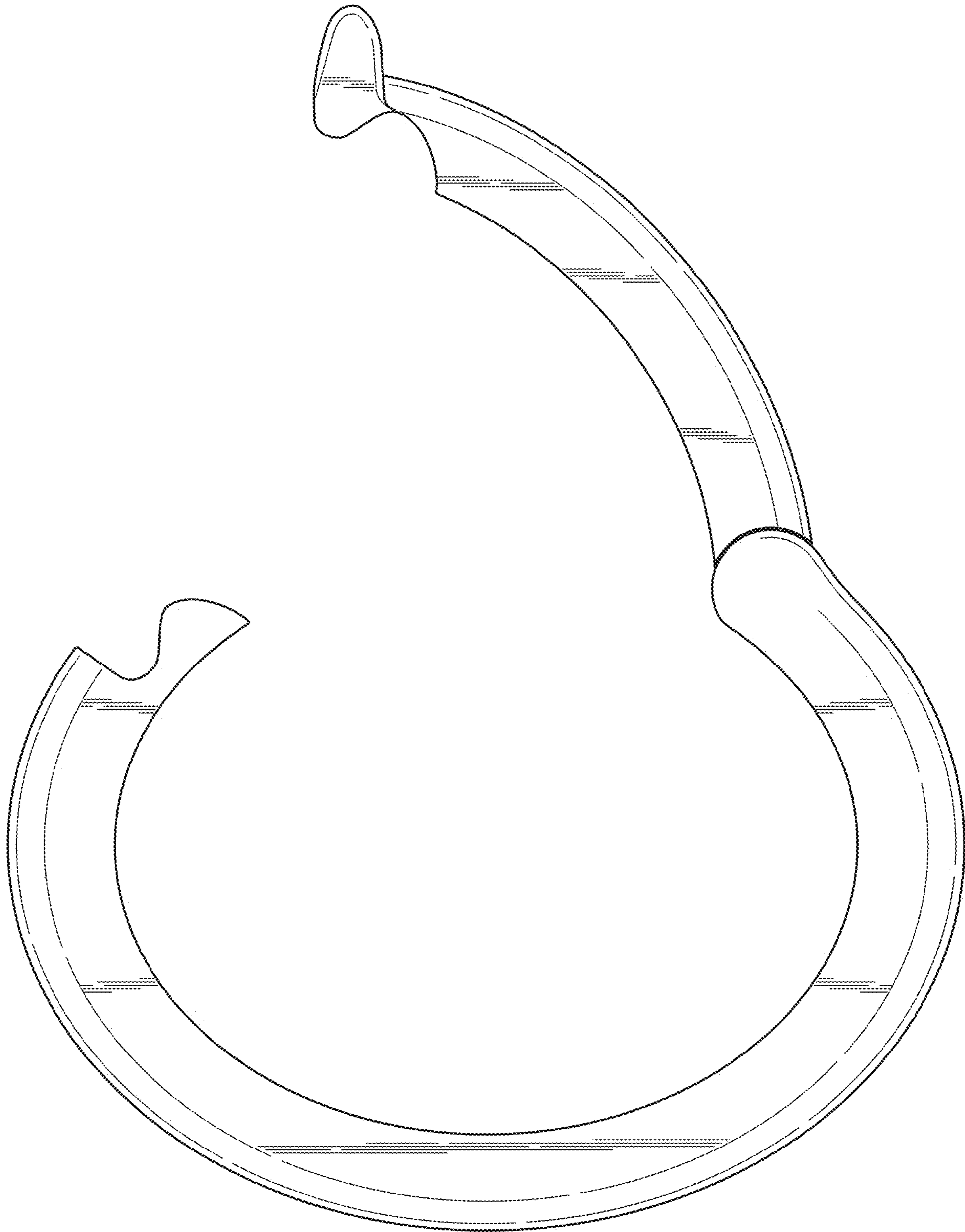

FIG. 42



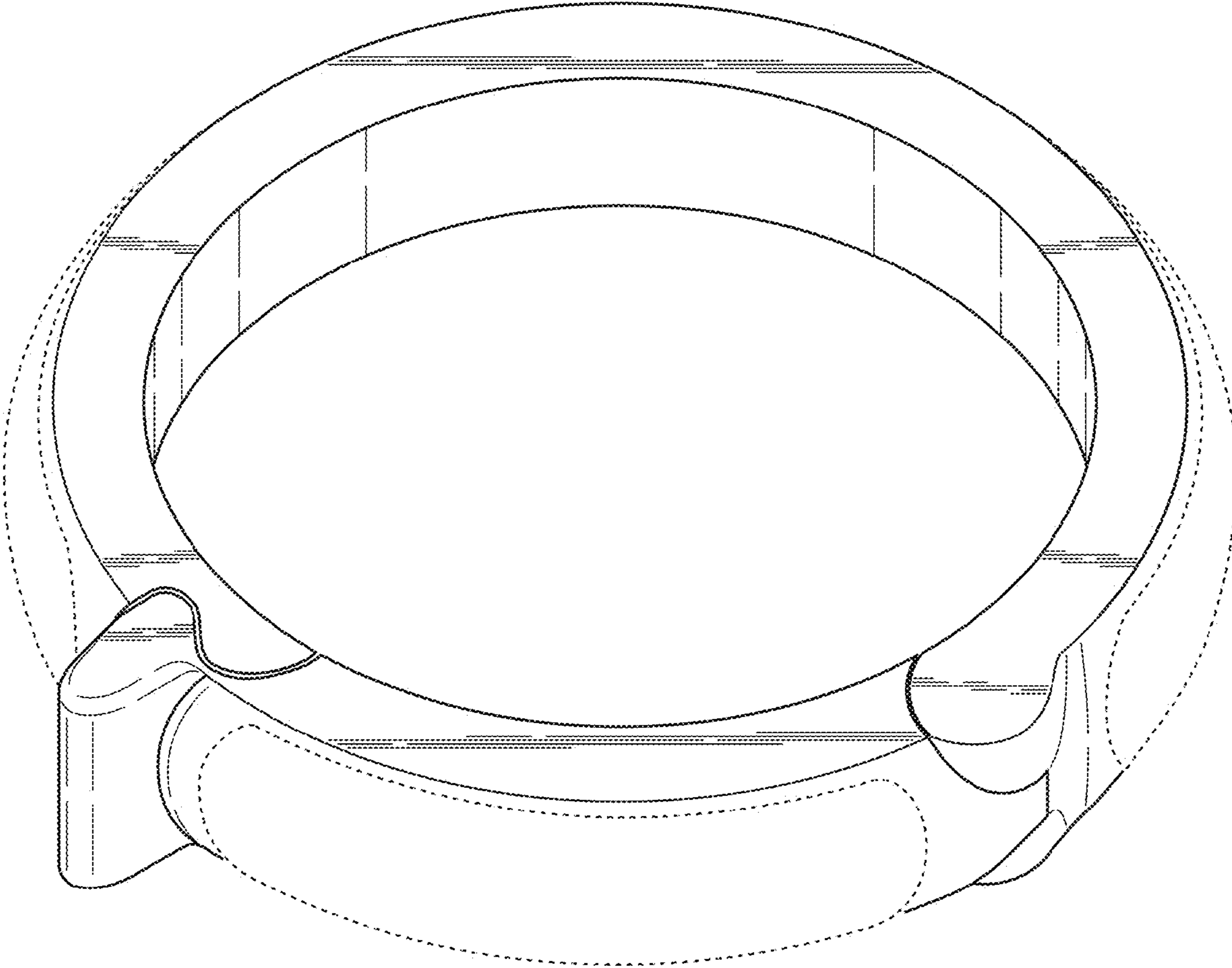

FIG. 43

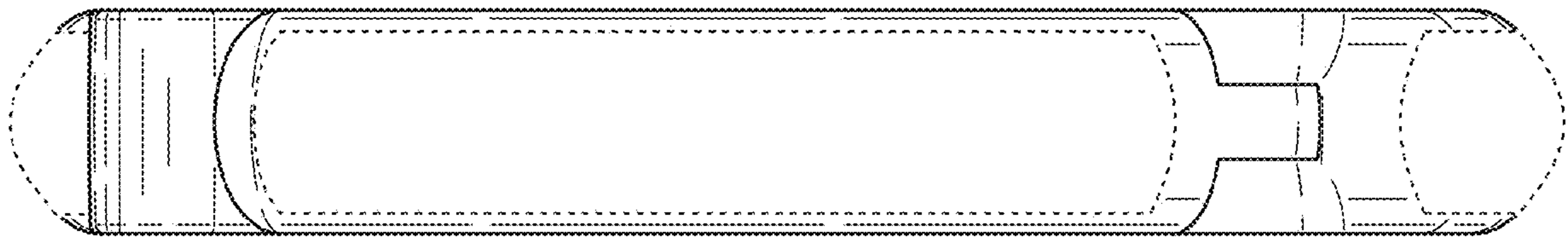

FIG. 44

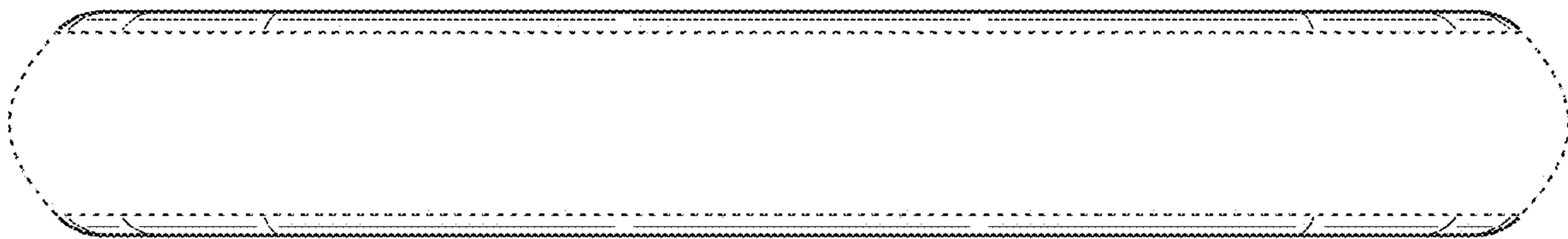

FIG. 45



FIG. 46

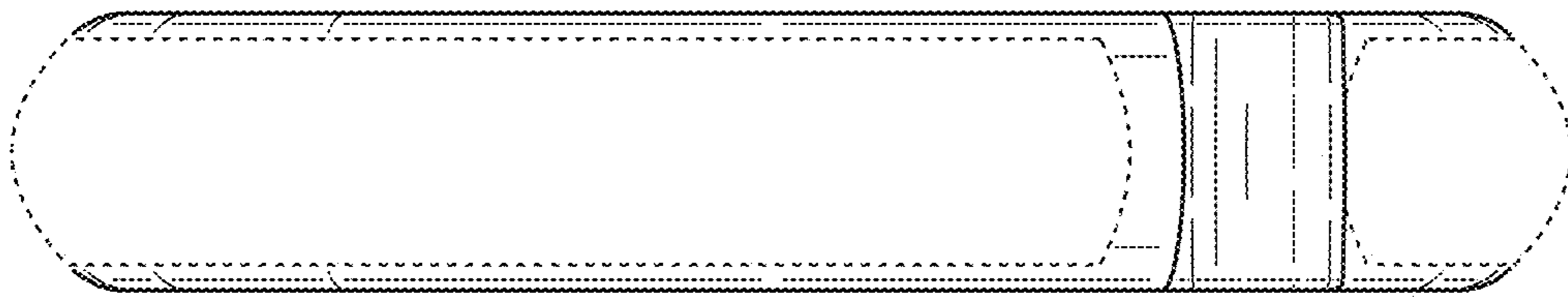

FIG. 47

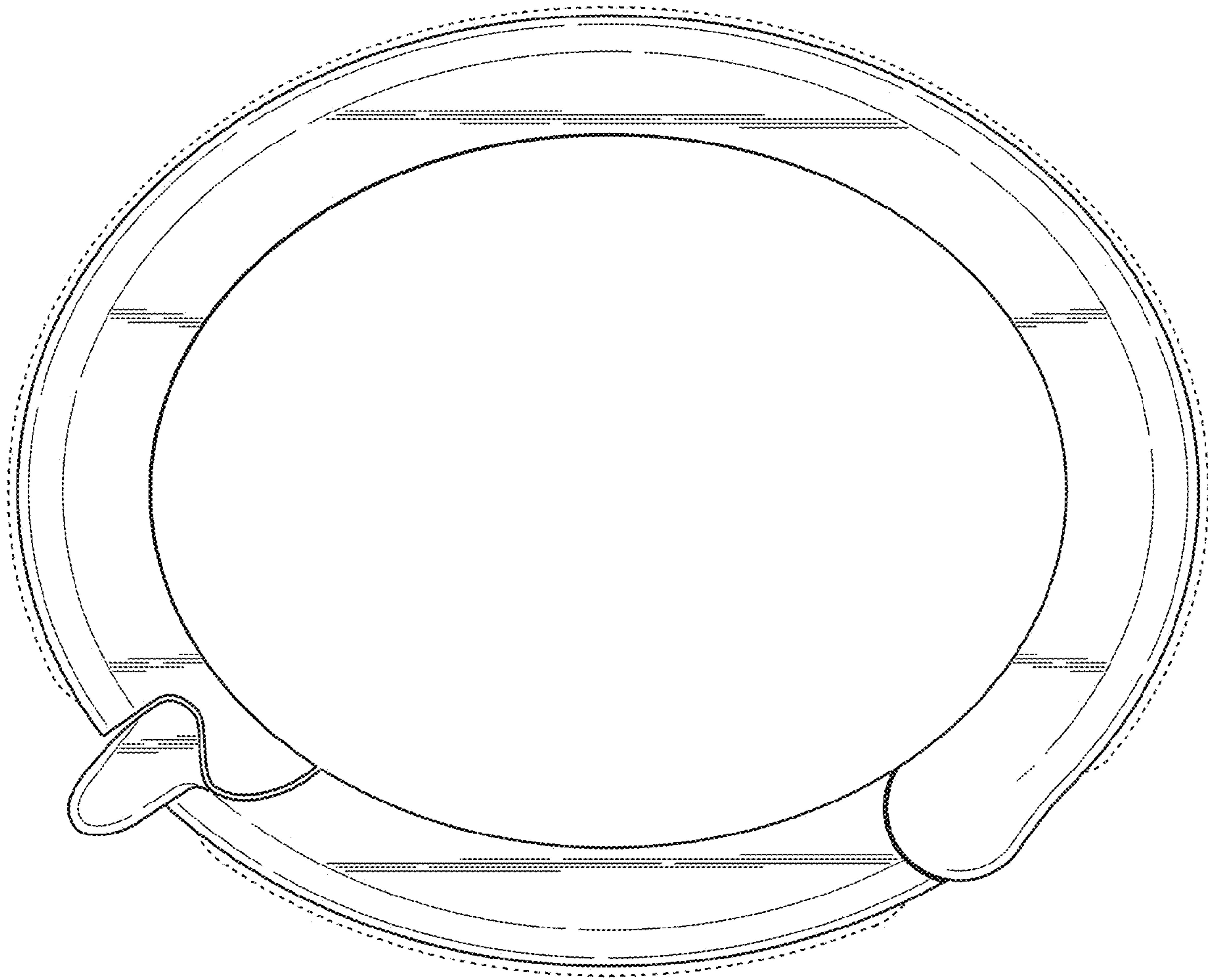

FIG. 48

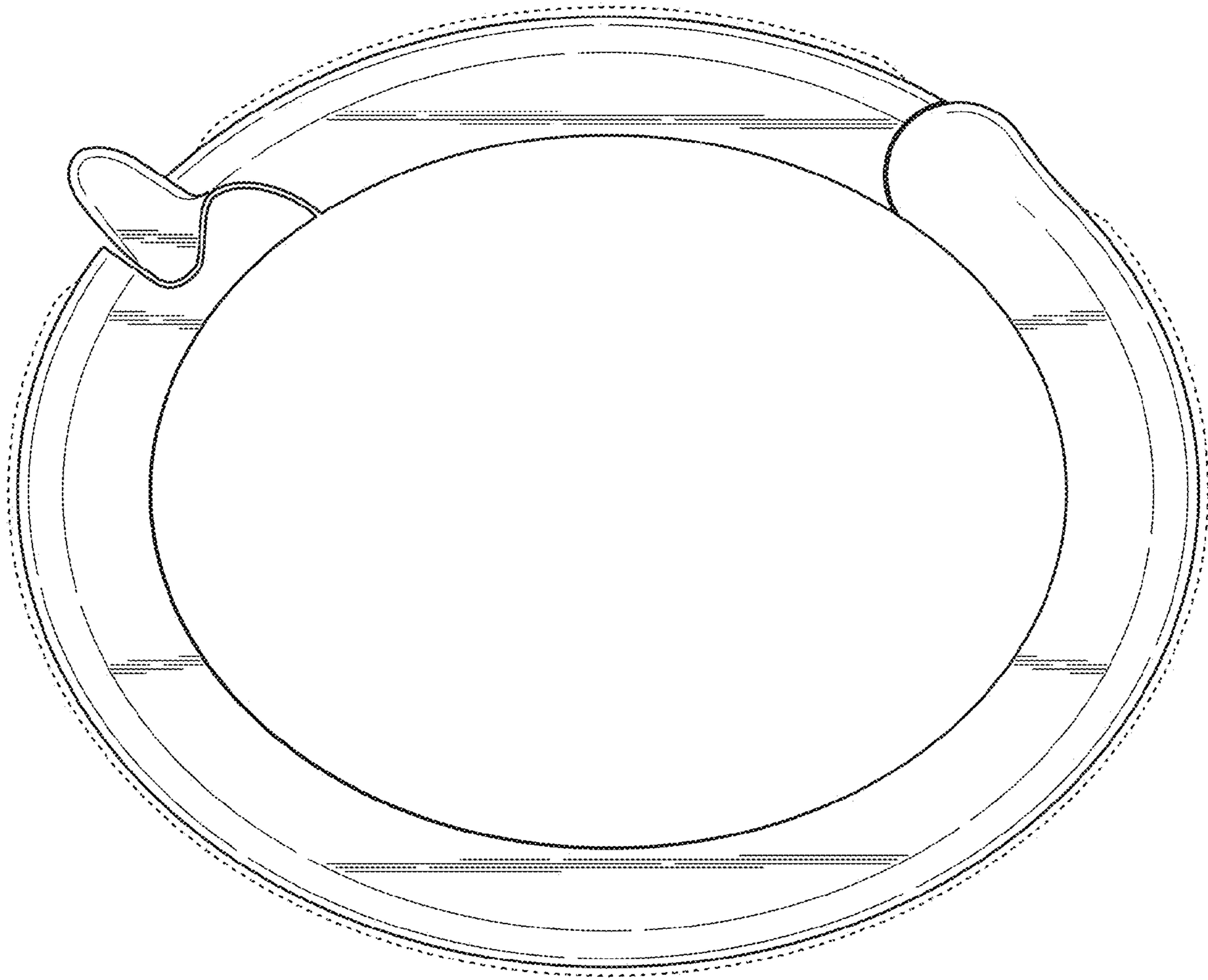

FIG. 49

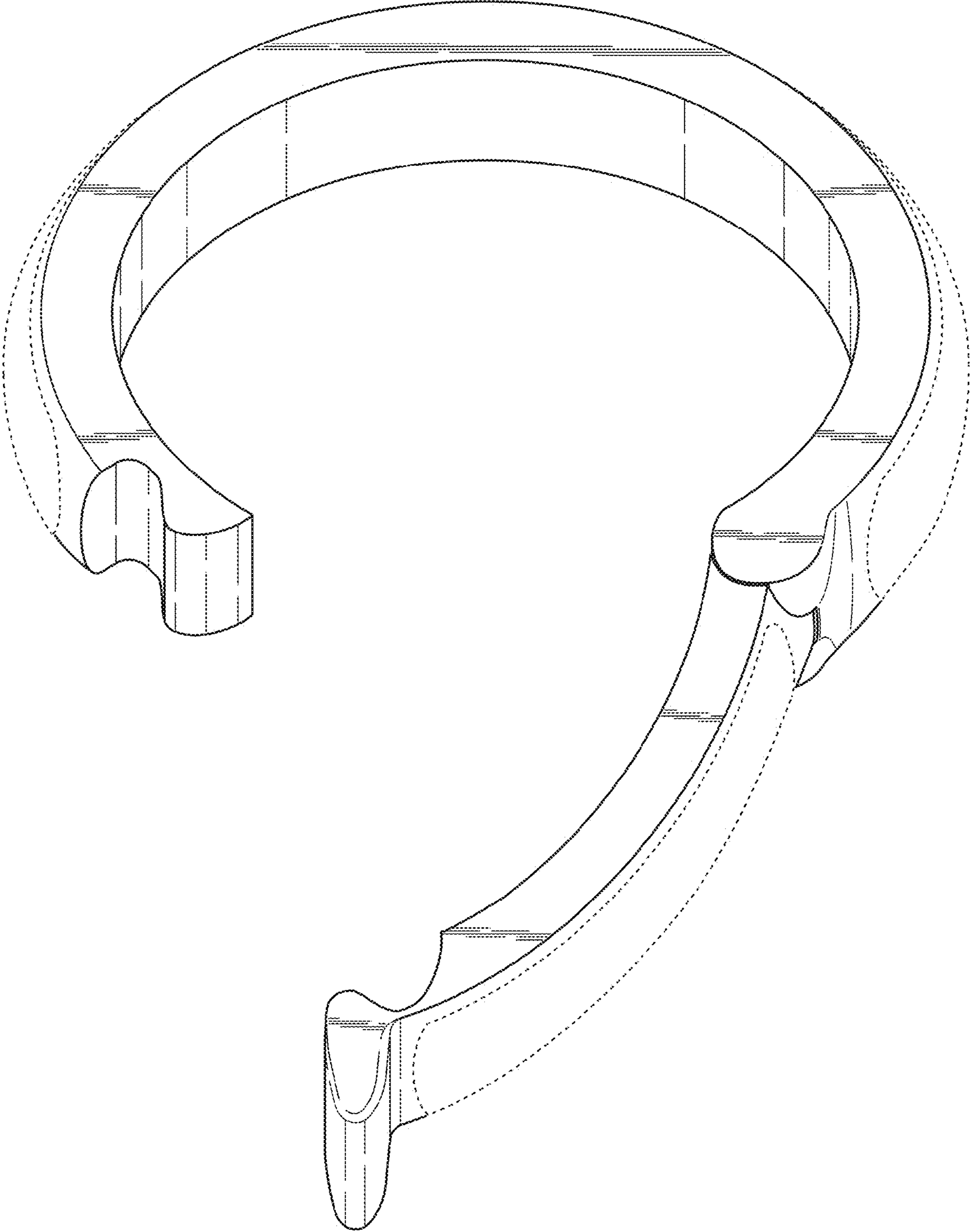

FIG. 50

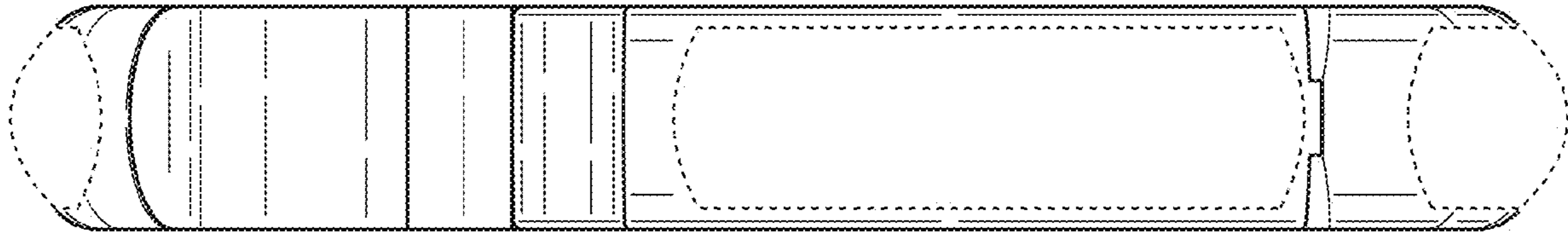

FIG. 51

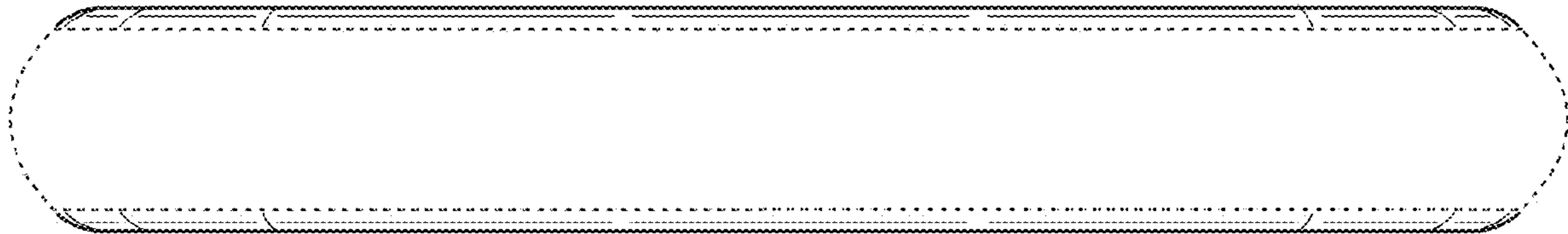

FIG. 52

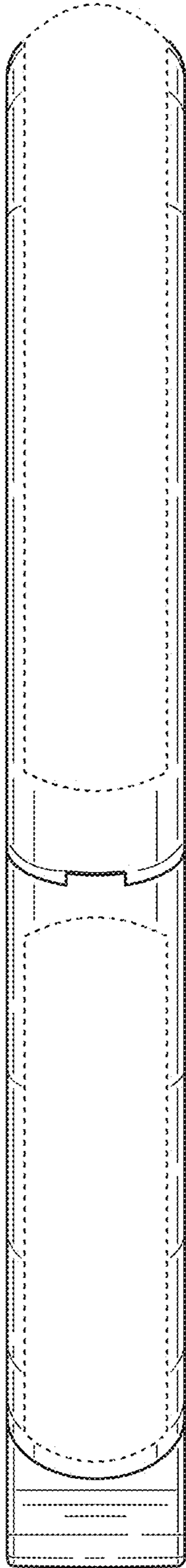

FIG. 53

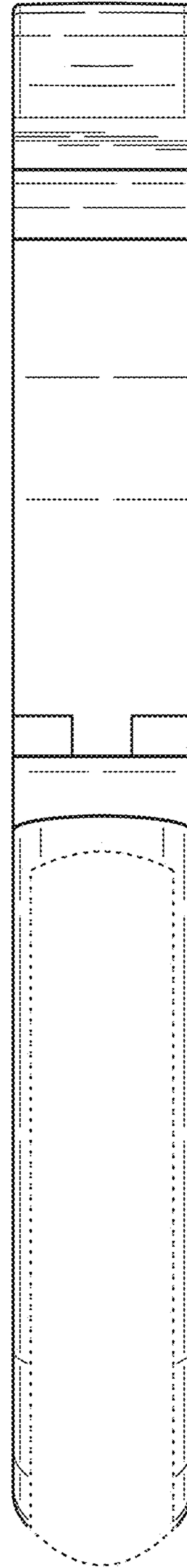

FIG. 54



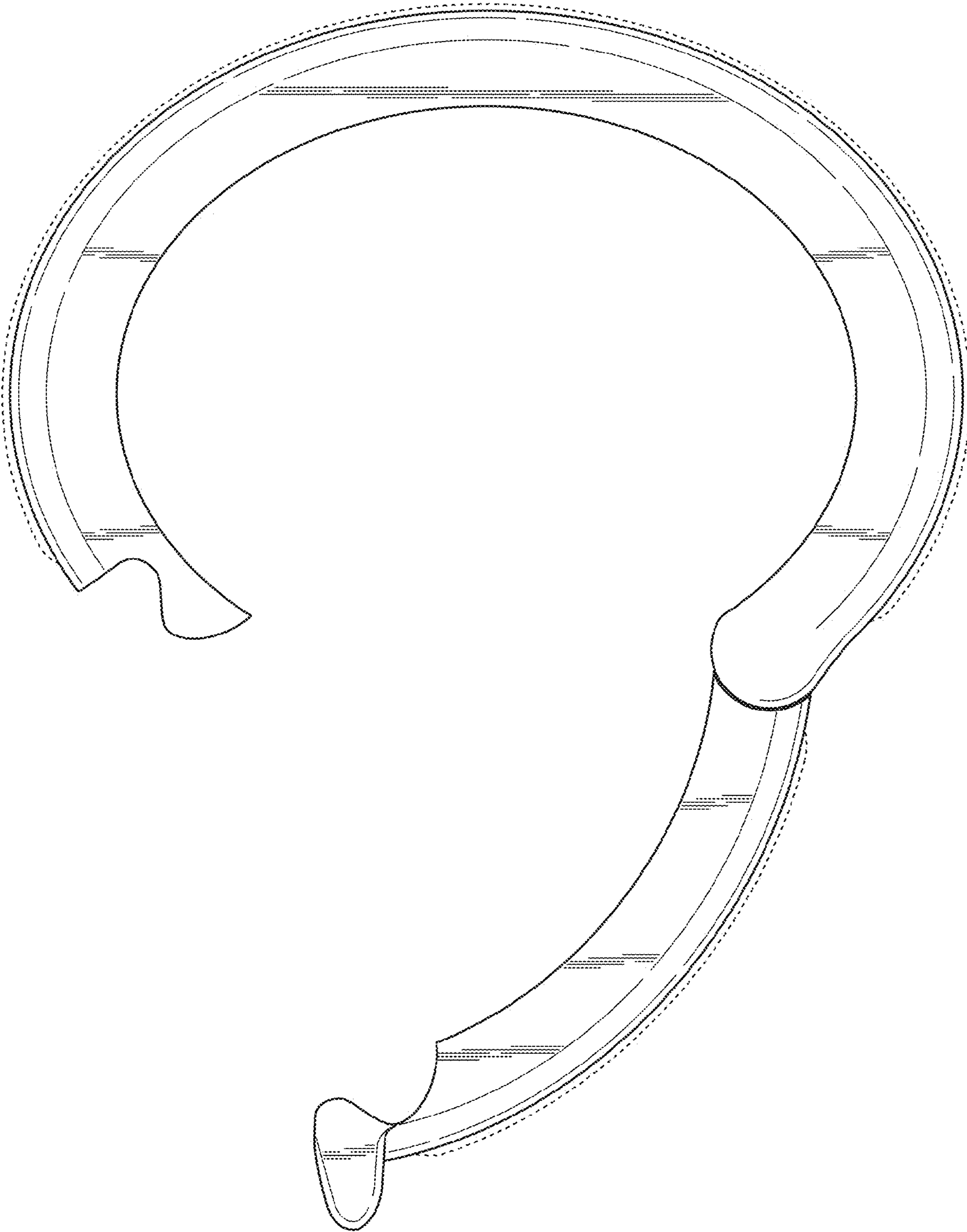

FIG. 55

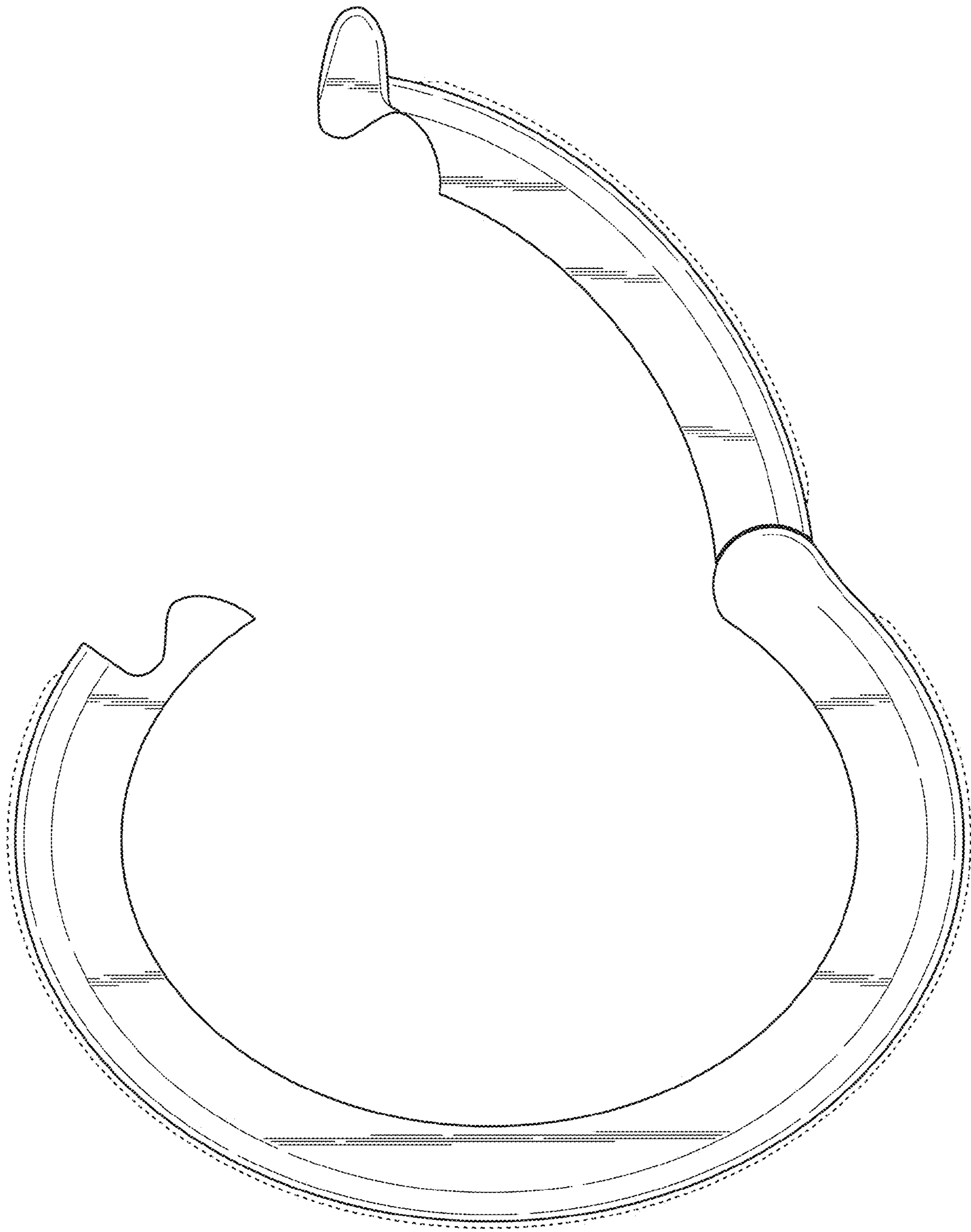

FIG. 56