

US00D969655S

(12) **United States Design Patent** (10) **Patent No.:** **US D969,655 S**
Walker et al. (45) **Date of Patent:** **** Nov. 15, 2022**

(54) **CASE FOR ELECTRONIC TAG WITH LANYARD**

D692,796 S * 11/2013 Medsker D11/221
D710,594 S * 8/2014 Vasquez D3/207
D749,442 S * 2/2016 Jung D10/106.9

(Continued)

(71) Applicant: **Nomad Goods, Inc.**, Santa Barbara, CA (US)

(72) Inventors: **Tanner Walker**, Santa Barbara, CA (US); **Nick Walden**, Santa Barbara, CA (US); **Ryan Thomas**, Santa Barbara, CA (US); **Jared Naito**, Santa Barbara, CA (US); **Mulin Yang**, Goleta, CA (US); **Tane Martin**, Santa Barbara, CA (US); **Brian Hahn**, Santa Barbara, CA (US)

(73) Assignee: **Nomad Goods, Inc.**, Santa Barbara, CA (US)

(**) Term: **15 Years**

(21) Appl. No.: **29/783,157**

(22) Filed: **May 11, 2021**

(51) **LOC (13) Cl.** **10-06**

(52) **U.S. Cl.**
USPC **D10/121**

(58) **Field of Classification Search**
USPC D10/70, 97, 103, 104.1, 104.2, 106.6, D10/106.9, 106.94, 121; D3/201, 207, D3/208, 218, 273; D11/221; D14/203.1, D14/204, 216
CPC G08B 13/2434; G08B 21/0291; E05B 73/0023; E05B 73/0041
See application file for complete search history.

(56) **References Cited**

U.S. PATENT DOCUMENTS

D251,274 S * 3/1979 Colan D3/207
D502,419 S * 3/2005 Copen D10/106.94
D521,231 S * 5/2006 Ng D3/208
D522,743 S * 6/2006 Lui D3/207
D647,810 S * 11/2011 Bohrer D10/106.9

OTHER PUBLICATIONS

Belkin AirTag Case with Strap, available in Amazon.com, date first available Apr. 26, 2021 [online], [site visited Sep. 22, 2022], Available from the internet URL: <https://www.amazon.com/AirTag-Protective-Scratch-Resistance-Accessory/dp/B093346F69>. (Year: 2021).*

Primary Examiner — George D. Kirschbaum

Assistant Examiner — Lillian Windham

(74) *Attorney, Agent, or Firm* — SoCal IP Law Group LLP; Steven C. Sereboff

(57) **CLAIM**

The ornamental design for electronic tag with a lanyard, as shown and described.

DESCRIPTION

A portion of the disclosure of this patent document contains material which is subject to copyright protection. This patent document may show and/or describe matter which is or may become trade dress of the owner. The copyright and trade dress owner has no objection to the facsimile reproduction by anyone of the patent disclosure as it appears in the Patent and Trademark Office patent files or records, but otherwise reserves all copyright and trade dress rights whatsoever.

FIG. 1 is a top perspective view of a case for electronic tag with a lanyard;

FIG. 2 is a bottom perspective view thereof;

FIG. 3 is a front view thereof;

FIG. 4 is a back view thereof;

FIG. 5 is a right-side view thereof;

FIG. 6 is a left-side view thereof;

FIG. 7 is a top view thereof; and,

FIG. 8 is a bottom view thereof.

1 Claim, 5 Drawing Sheets

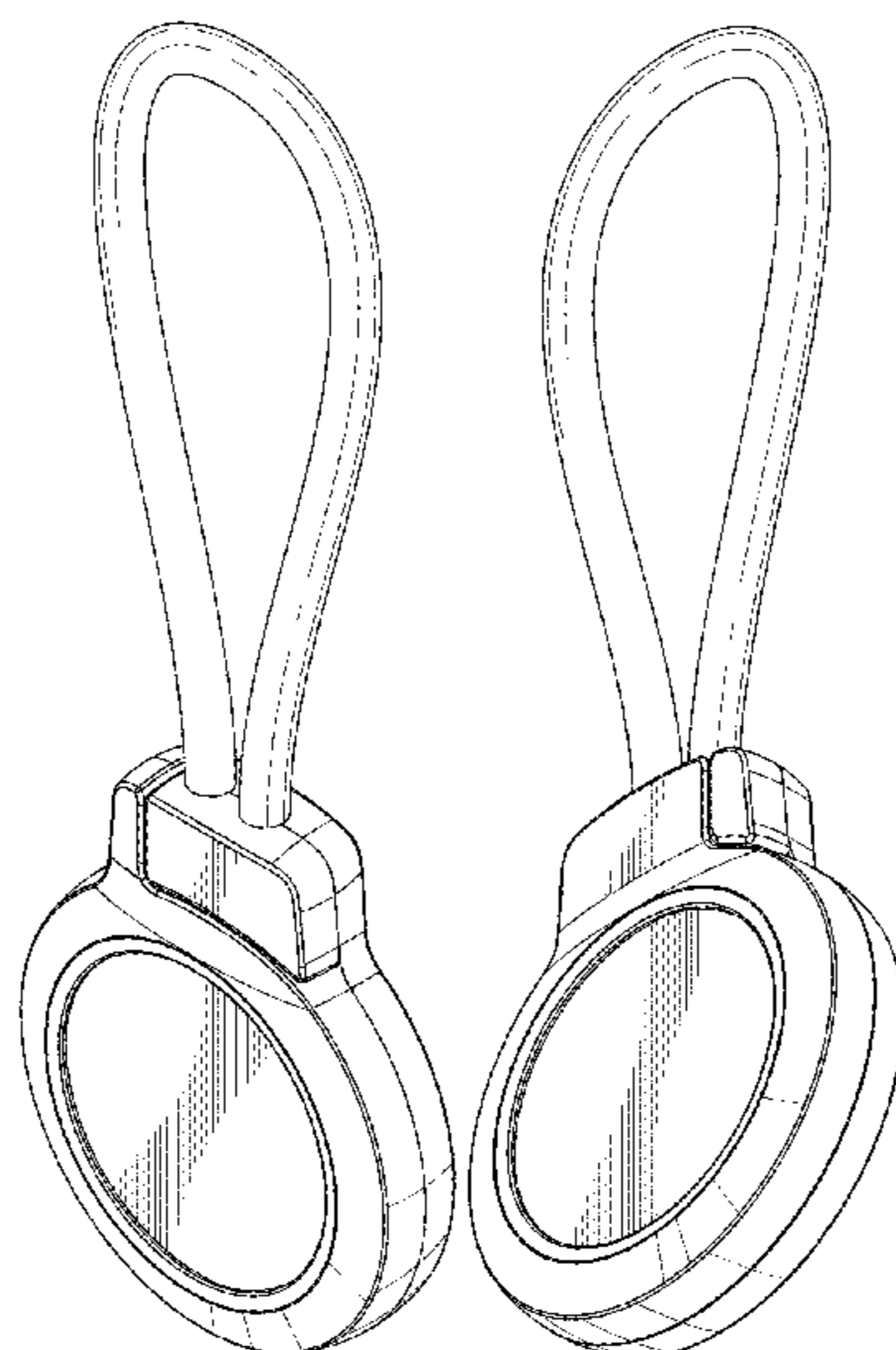

(56)

References Cited

U.S. PATENT DOCUMENTS

D758,902 S *	6/2016	Benoit	D10/70
D760,097 S *	6/2016	Benoit	D10/70
D797,704 S *	9/2017	Fischer	D14/216
D828,333 S *	9/2018	Hu	D14/216
D828,784 S *	9/2018	Wong	D11/221
D909,333 S *	2/2021	Wu	D14/204
D960,017 S *	8/2022	Wu	D10/121

* cited by examiner

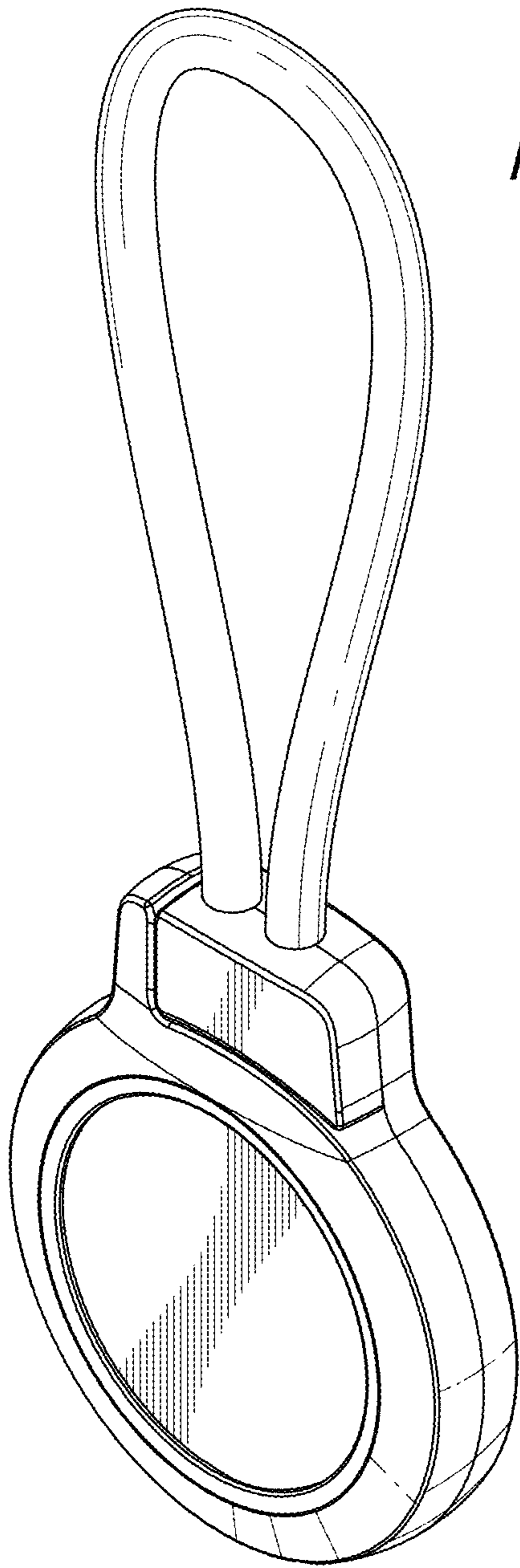

FIG. 1

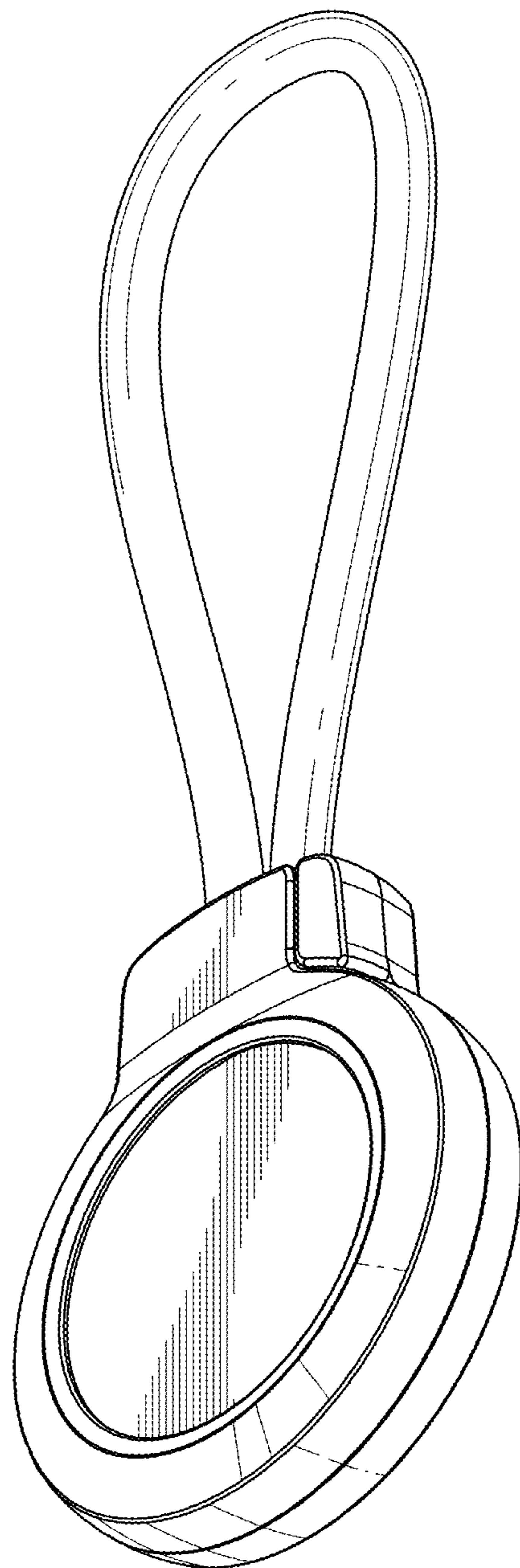

FIG. 2

FIG. 3

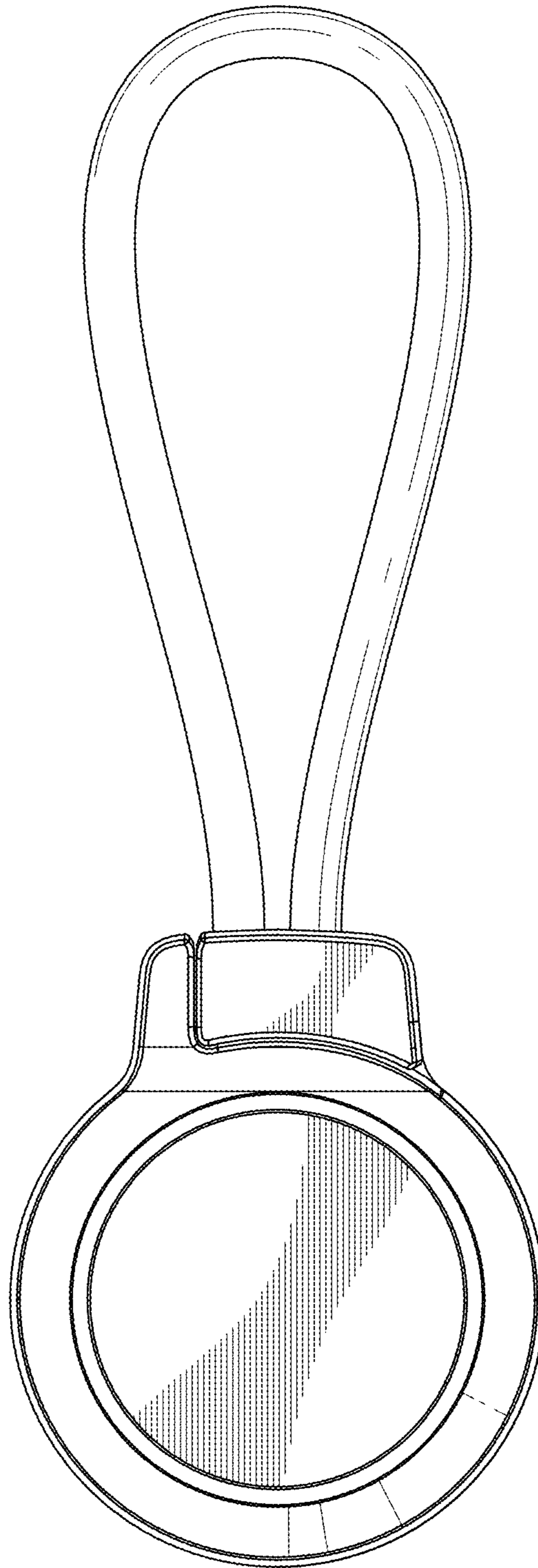
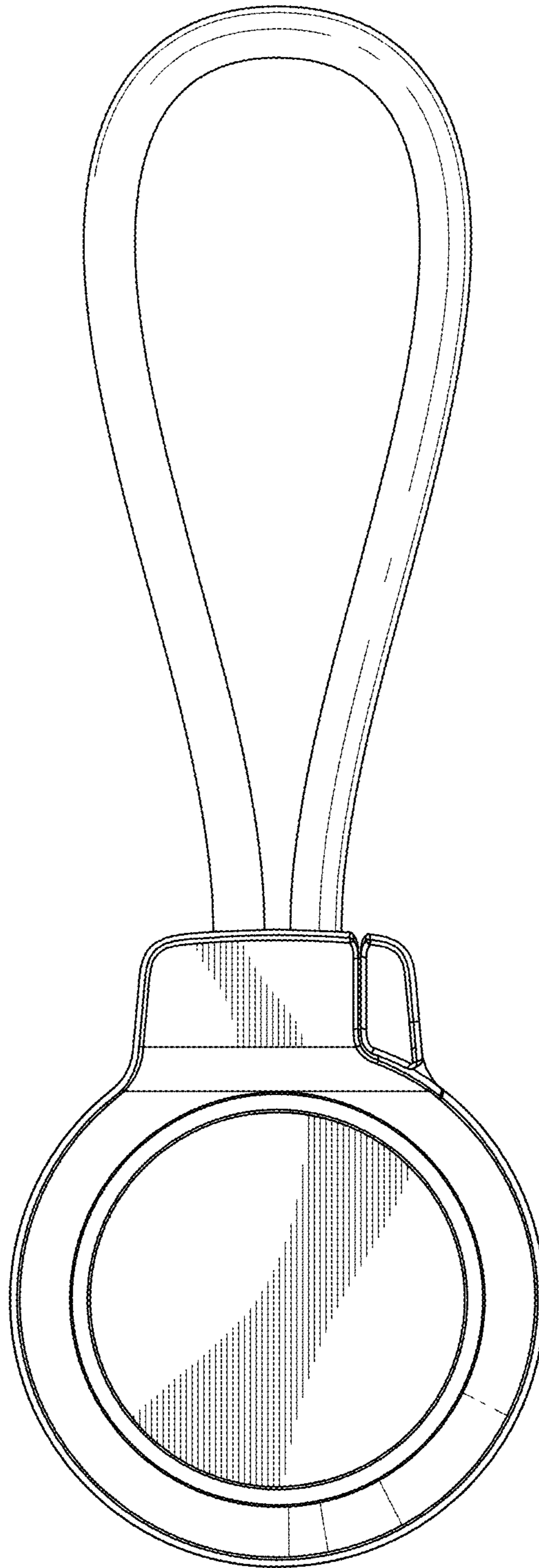

FIG. 4



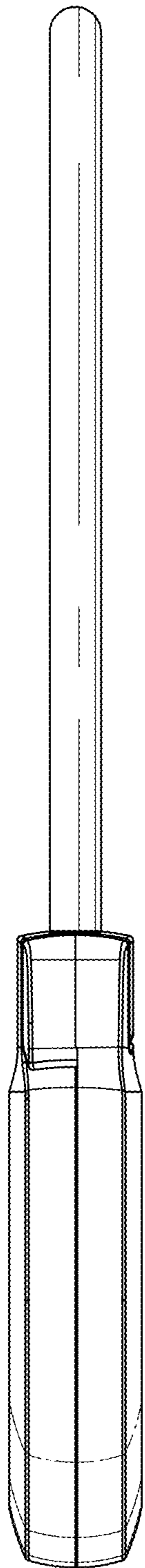

FIG. 5

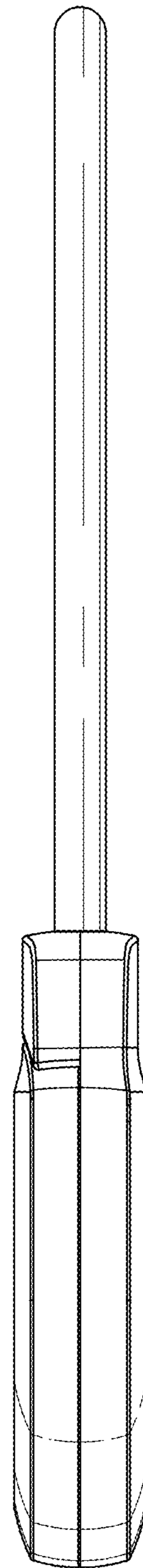

FIG. 6

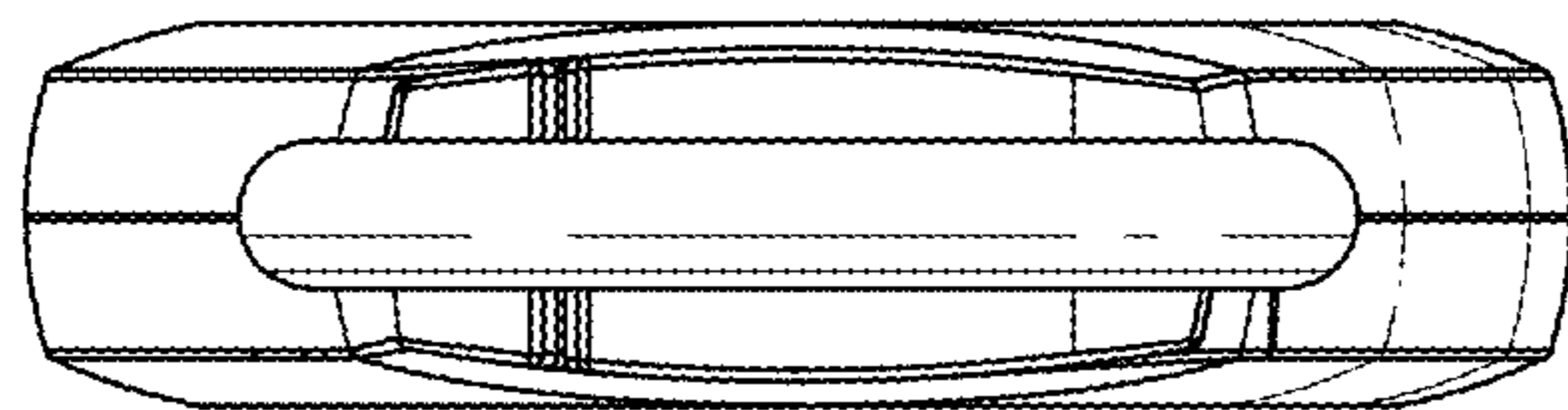

FIG. 7

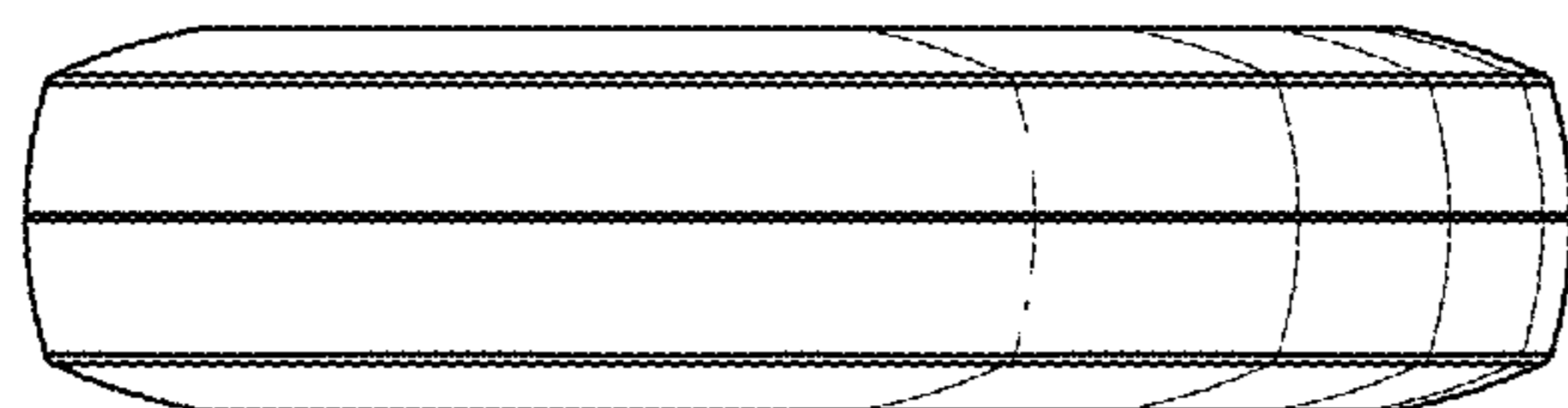

FIG. 8