

US00D969559S

(12) **United States Design Patent**
Lown

(10) **Patent No.:** **US D969,559 S**

(45) **Date of Patent:** **** Nov. 15, 2022**

(54) **FLUID CONTAINER**

(71) Applicant: **Takeya USA Corporation**, Costa Mesa, CA (US)

(72) Inventor: **John M. Lown**, Huntington Beach, CA (US)

(73) Assignee: **Takeya USA Corporation**, Costa Mesa, CA (US)

(**) Term: **15 Years**

(21) Appl. No.: **29/712,928**

(22) Filed: **Nov. 12, 2019**

(51) **LOC (13) Cl.** **07-01**

(52) **U.S. Cl.**

USPC **D7/511**

(58) **Field of Classification Search**

USPC D3/202; D7/300, 300.1, 320, 392, 392.1, D7/396.2, 396.3, 507, 509-511, 513, 523, D7/529-536; D9/443, 500-504, 519, D9/520, 529-531, 532, 535-537, 539, D9/549-551

CPC A47G 19/22; A47G 19/2205; A47G 19/2222; A47G 19/2233; A47G 19/2266; A47G 19/2288; B65D 23/00; B65D 41/0471; B65D 41/0478; B65D 41/065; B65D 51/241; A47J 41/00; A47J 41/0055;

(Continued)

(56) **References Cited**

U.S. PATENT DOCUMENTS

D686,040 S * 7/2013 Lane D7/510
D696,130 S * 12/2013 Zabari D9/449
D761,058 S * 7/2016 Ou D7/510

(Continued)

FOREIGN PATENT DOCUMENTS

EM 006658662-0001 * 9/2019
JP D1631073 5/2019

(Continued)

OTHER PUBLICATIONS

Bradford, Reilly, "15 Stylish and Portable Water Bottles for Every Personality," May 9, 2018, Everyday Health, www.everydayhealth.com/healthy-living/best-water-bottles-help-keep-you-hydrated/ (Year: 2018).*

(Continued)

Primary Examiner — Joseph Kukella

Assistant Examiner — Arva P Adams

(74) *Attorney, Agent, or Firm* — KOS IP Law LLP

(57) **CLAIM**

The ornamental design for a fluid container, as shown and described.

DESCRIPTION

FIG. 1 is a front perspective view of a fluid container embodying my new design, which has a lid attached to a container vessel;

FIG. 2 is a rear perspective view thereof;

FIG. 3 is a front perspective view thereof, with a ring of the lid in an open position;

FIG. 4 is a rear perspective view thereof;

FIG. 5 is a front perspective view thereof, with the ring and a top cover of the lid in an open position;

FIG. 6 is a rear perspective view thereof;

FIG. 7 is a front elevation view of the fluid container of FIG. 1;

FIG. 8 is a rear elevation view thereof;

FIG. 9 is a right elevation view thereof;

FIG. 10 is a top plan view thereof; and,

FIG. 11 is a bottom plan view thereof.

The broken lines show portions of the fluid container that form no part of the claimed design.

The shading lines only help to show the shape and do not depict any surface decoration.

1 Claim, 7 Drawing Sheets

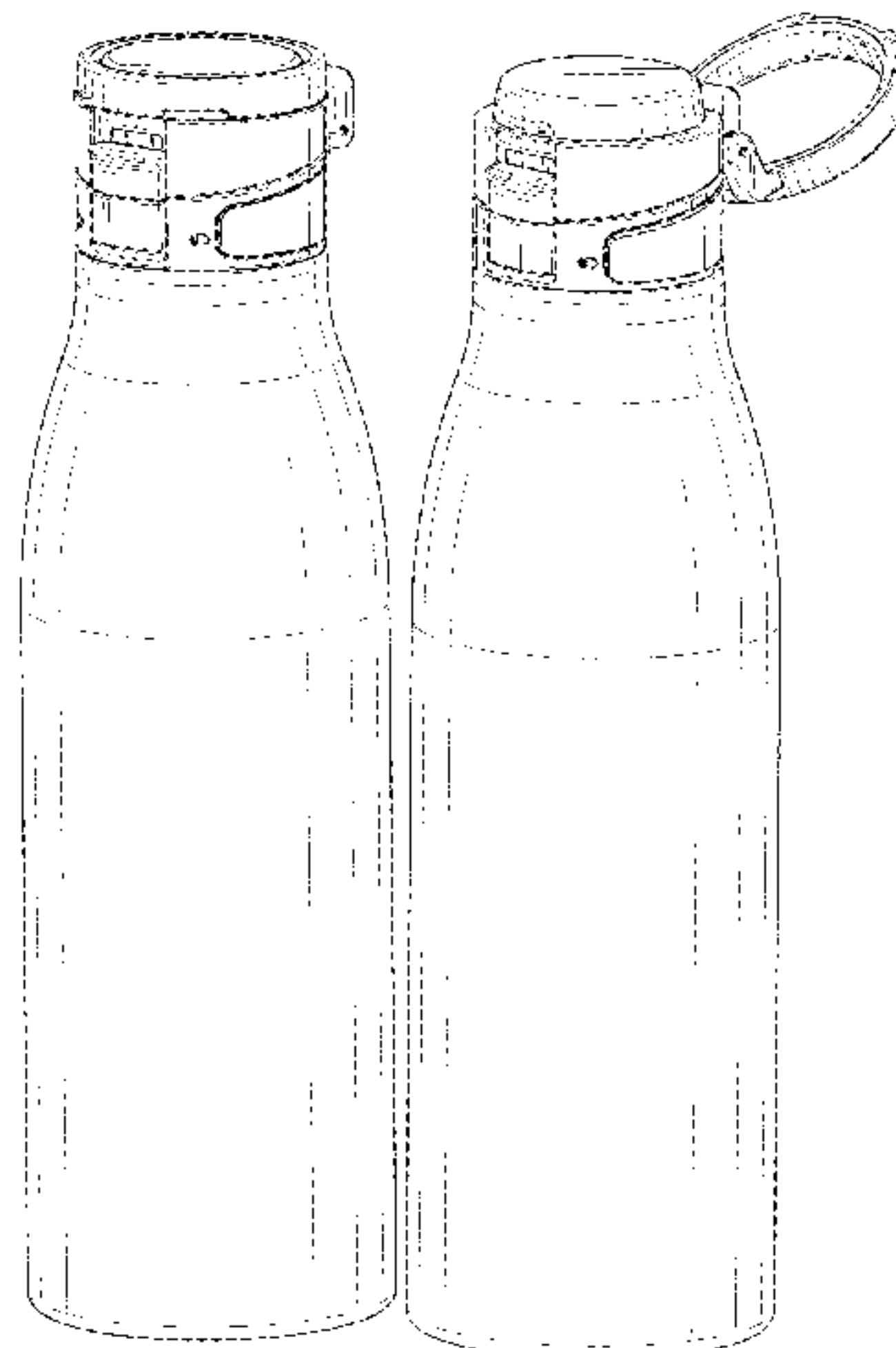

(58) **Field of Classification Search**

CPC A47J 41/0072; A47J 41/02; A47J 41/028;
A47J 41/0011

See application file for complete search history.

FOREIGN PATENT DOCUMENTS

KR	3008986270000	3/2017
KR	300987448.0000	* 12/2018
TW	D182873	5/2017
TW	D183342	6/2017

(56) **References Cited**

U.S. PATENT DOCUMENTS

D795,011 S *	8/2017	Pisarevsky	A47J 41/028 D7/510
D799,900 S *	10/2017	Santos	D9/503
D821,815 S *	7/2018	Chung	D7/510
D830,128 S *	10/2018	Rohe	D7/532
D830,773 S *	10/2018	Jacobsen	D9/503
D832,651 S *	11/2018	Wiet	D7/511
D853,194 S *	7/2019	Ke	D7/532
D884,424 S *	5/2020	Bowling	D7/532
D925,286 S *	7/2021	Lown	D7/510
2018/0353011 A1 *	12/2018	Pinelli	A47J 41/028

OTHER PUBLICATIONS

Amazon.com, "Takeya Traveler Insulated Travel Mug," Jul. 10, 2019, Amazon.com, www.amazon.com/dp/B07V2B9M83 (Year: 2019).*

Amazon.ca, "Ello Riley Bouteille," Jan. 23, 2019, Amazon.ca, www.amazon.ca/dp/B07JGCVBZ6 (Year: 2019).*

Office Action with Search Report from Taiwanese Intellectual Property Office on co-pending TW application (TW108304707) dated Feb. 13, 2020.

* cited by examiner

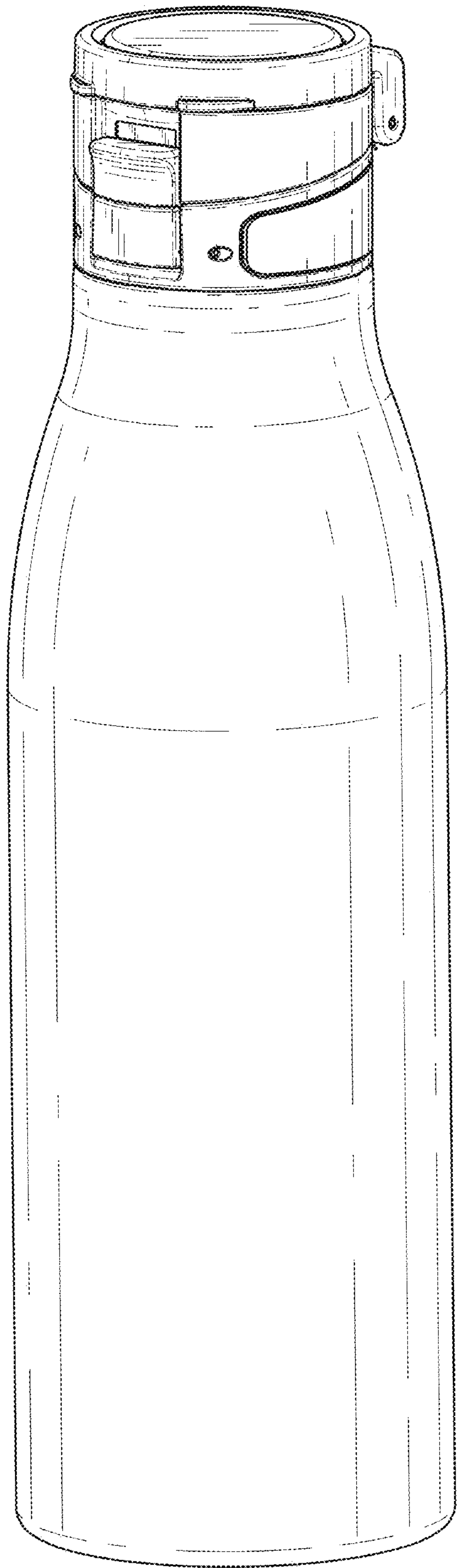

FIG. 1

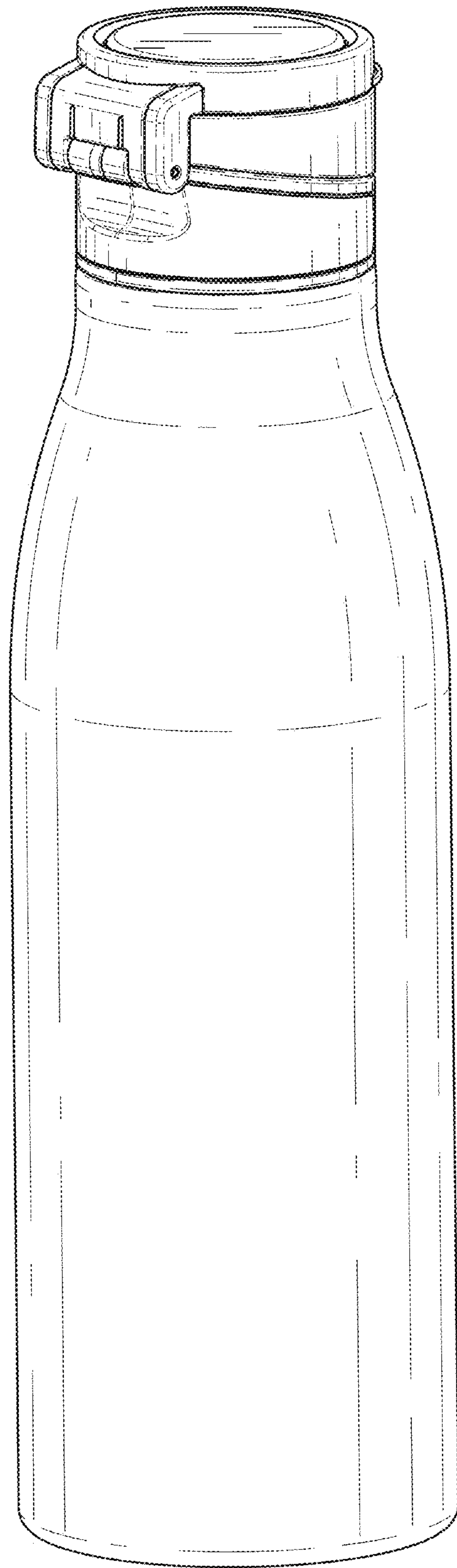

FIG. 2

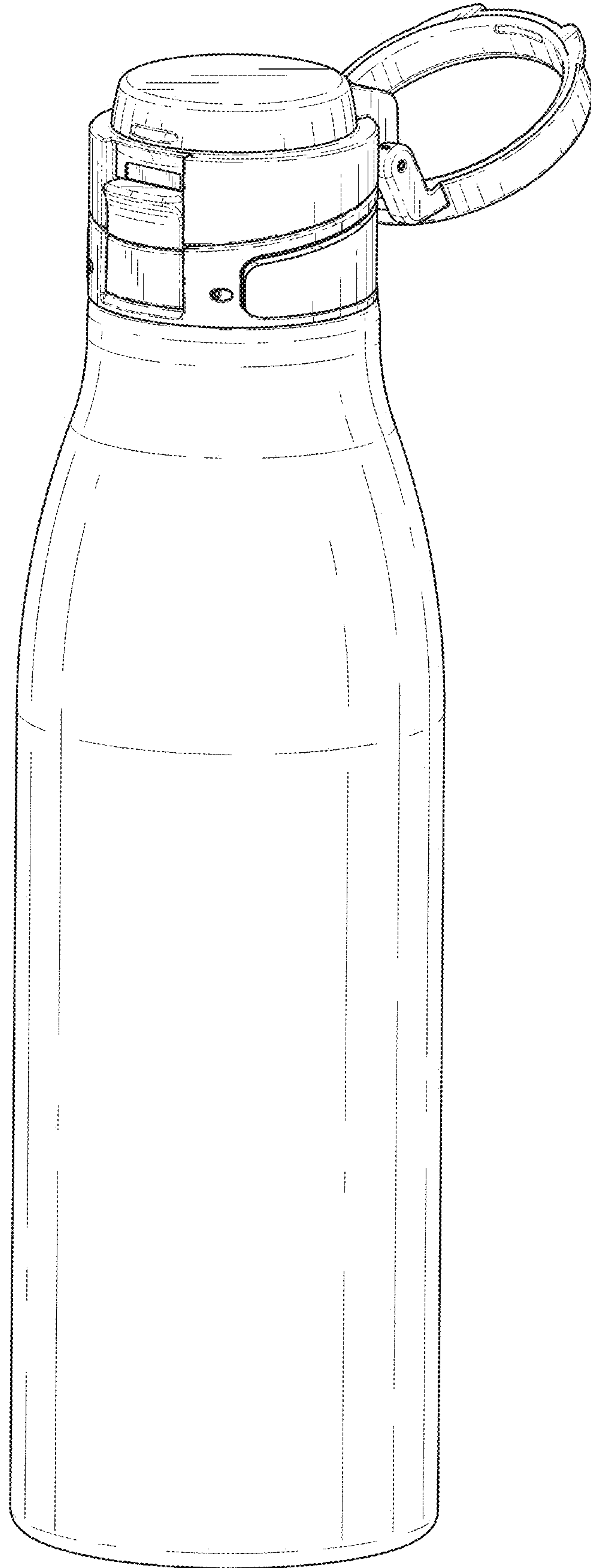

FIG. 3

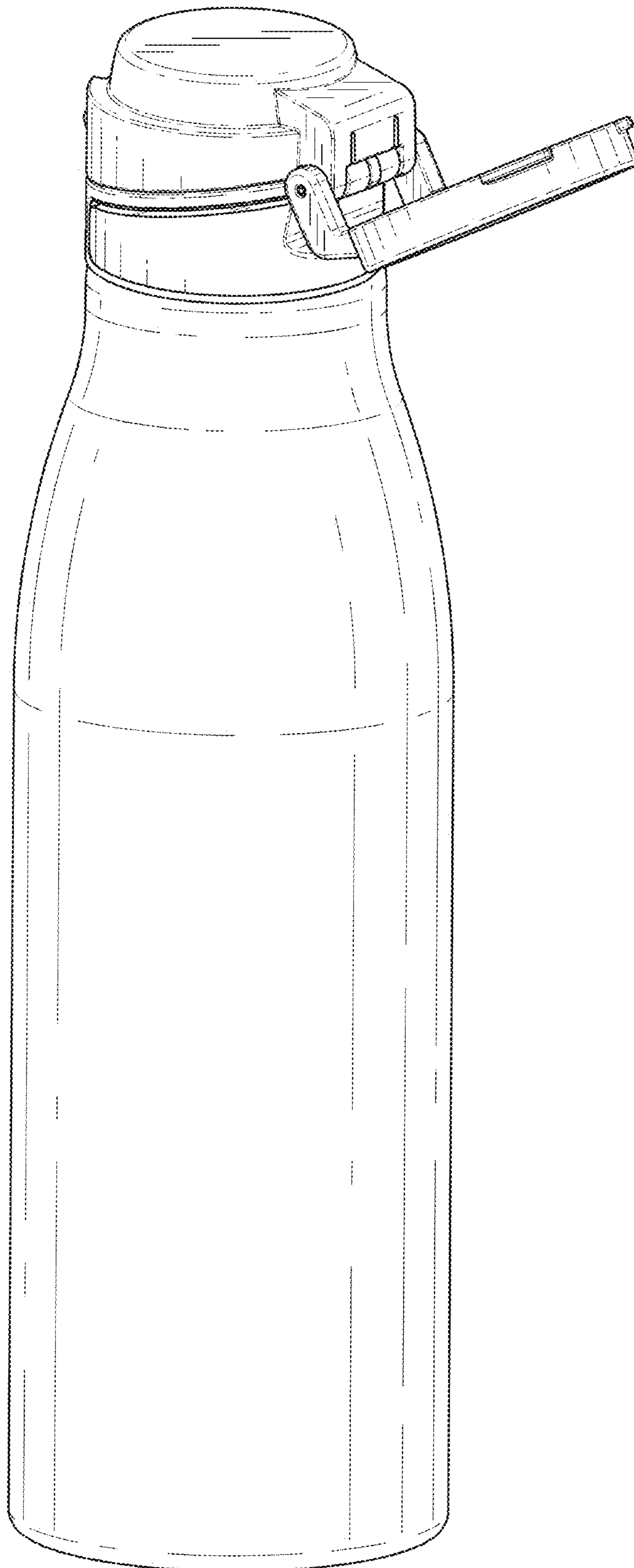

FIG. 4

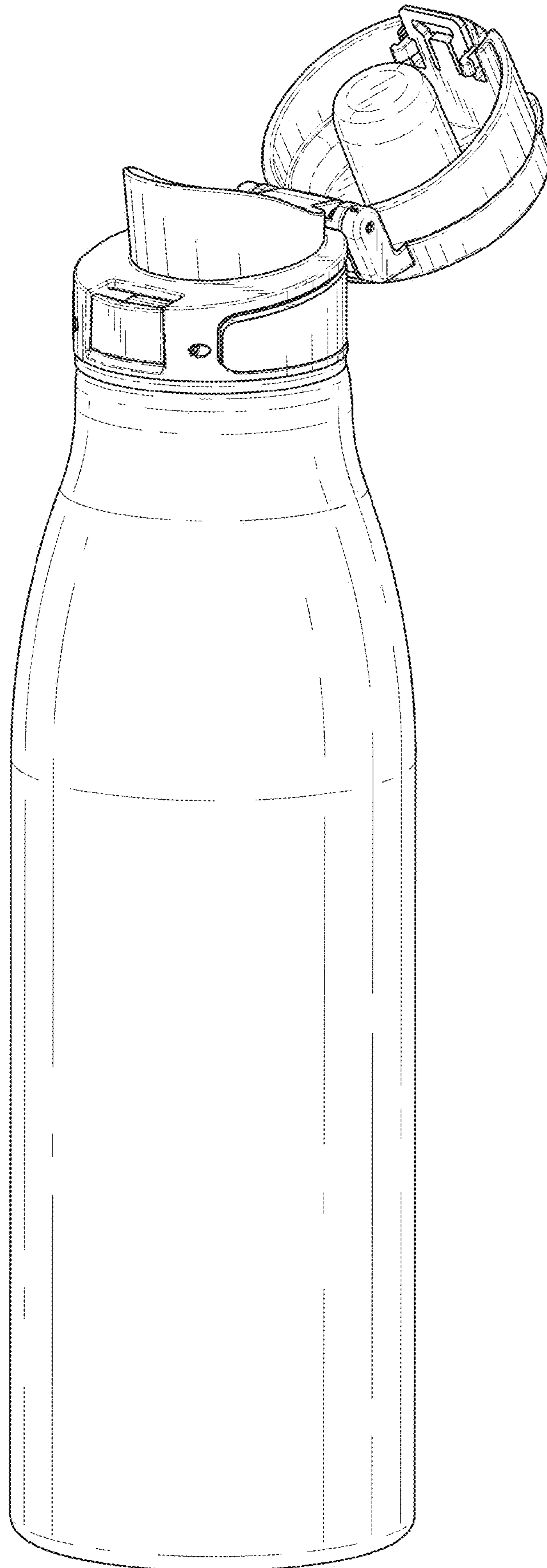

FIG. 5

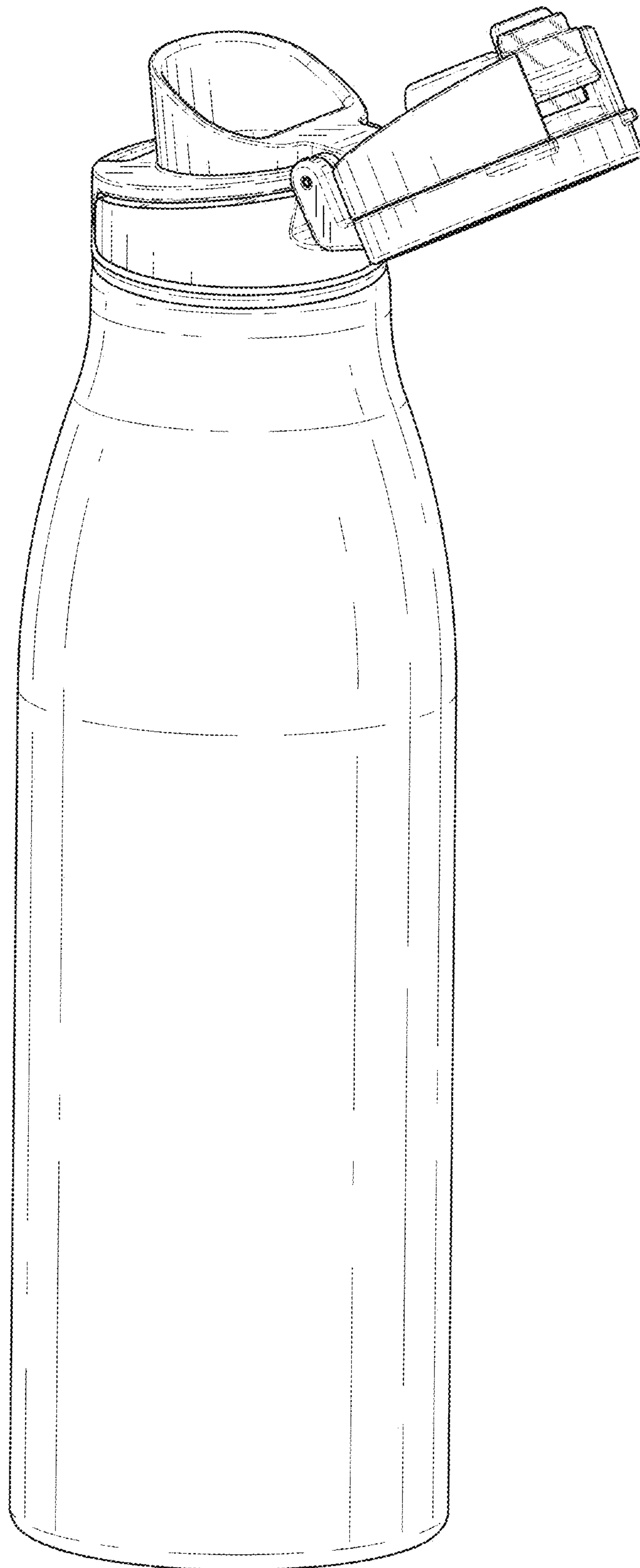

FIG. 6

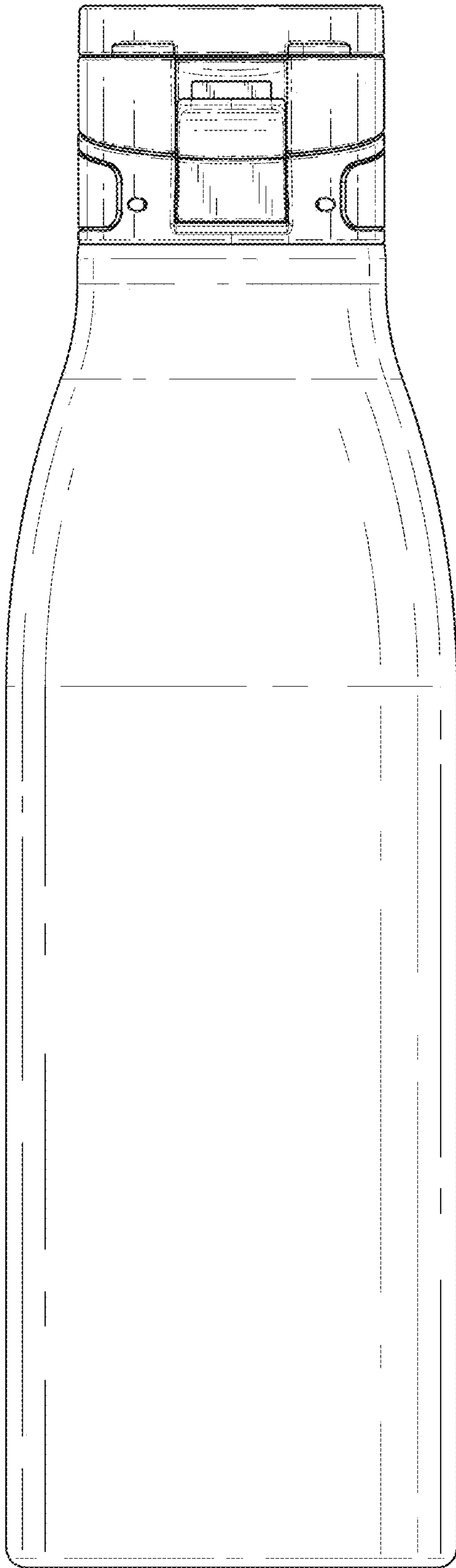

FIG. 7

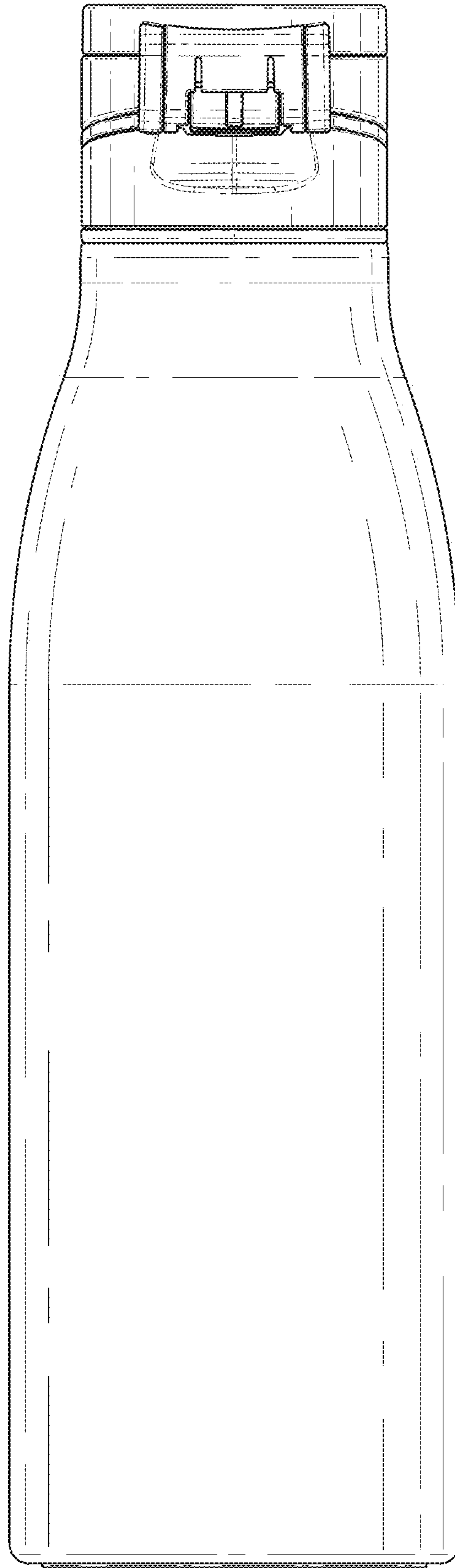

FIG. 8

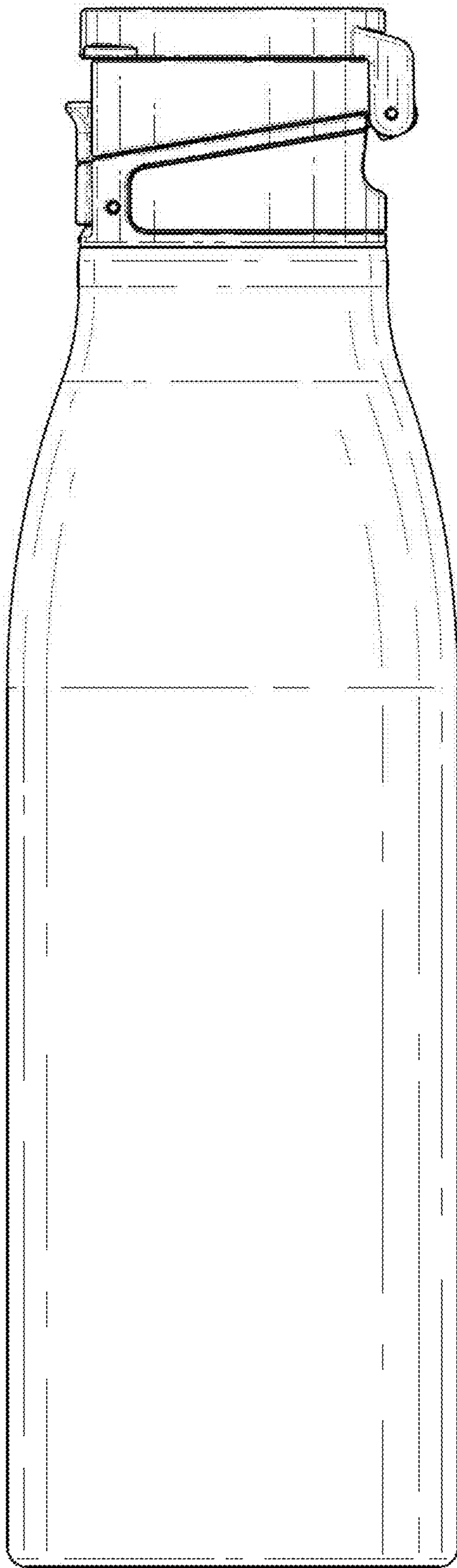

FIG. 9

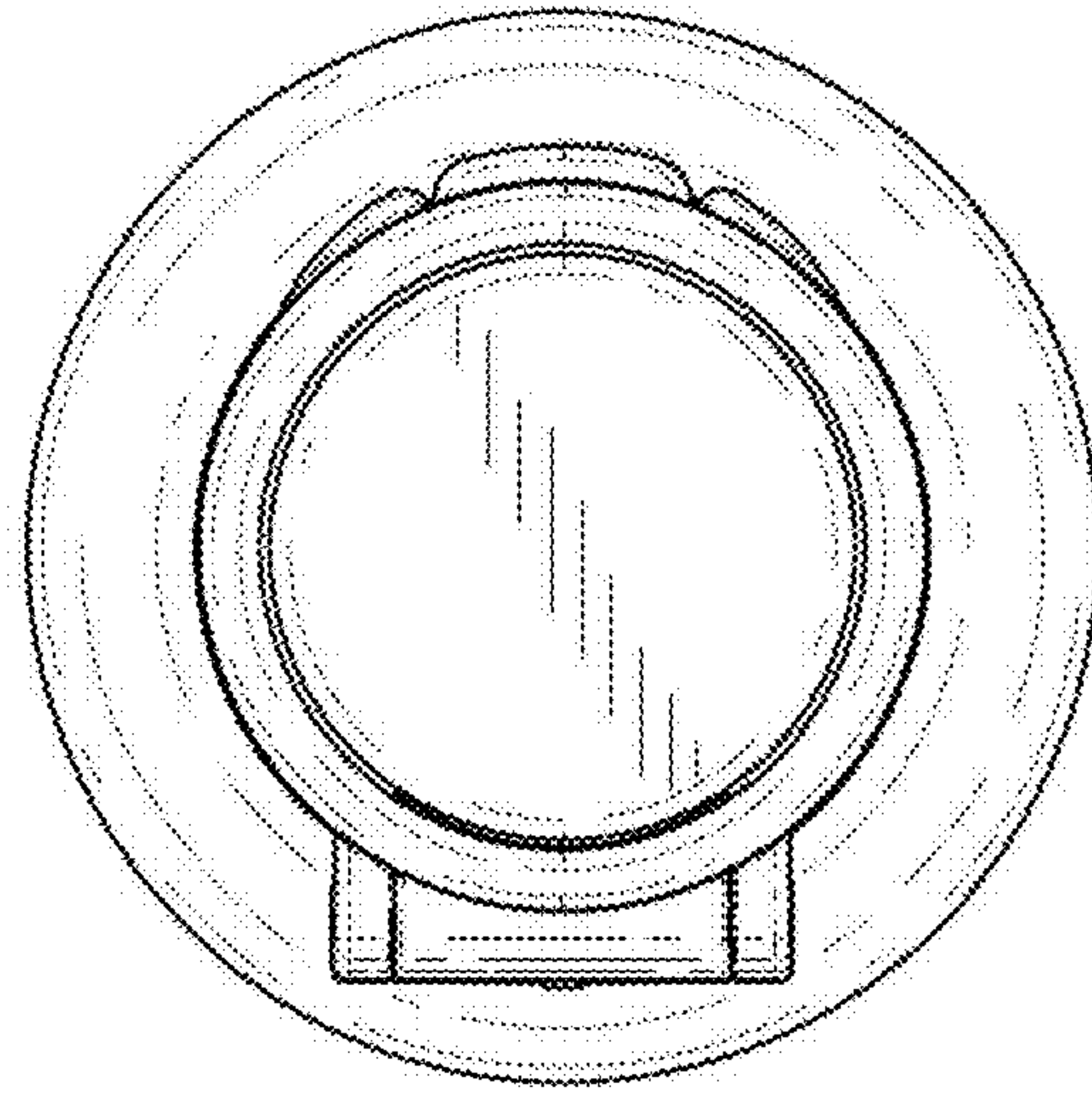

FIG. 10

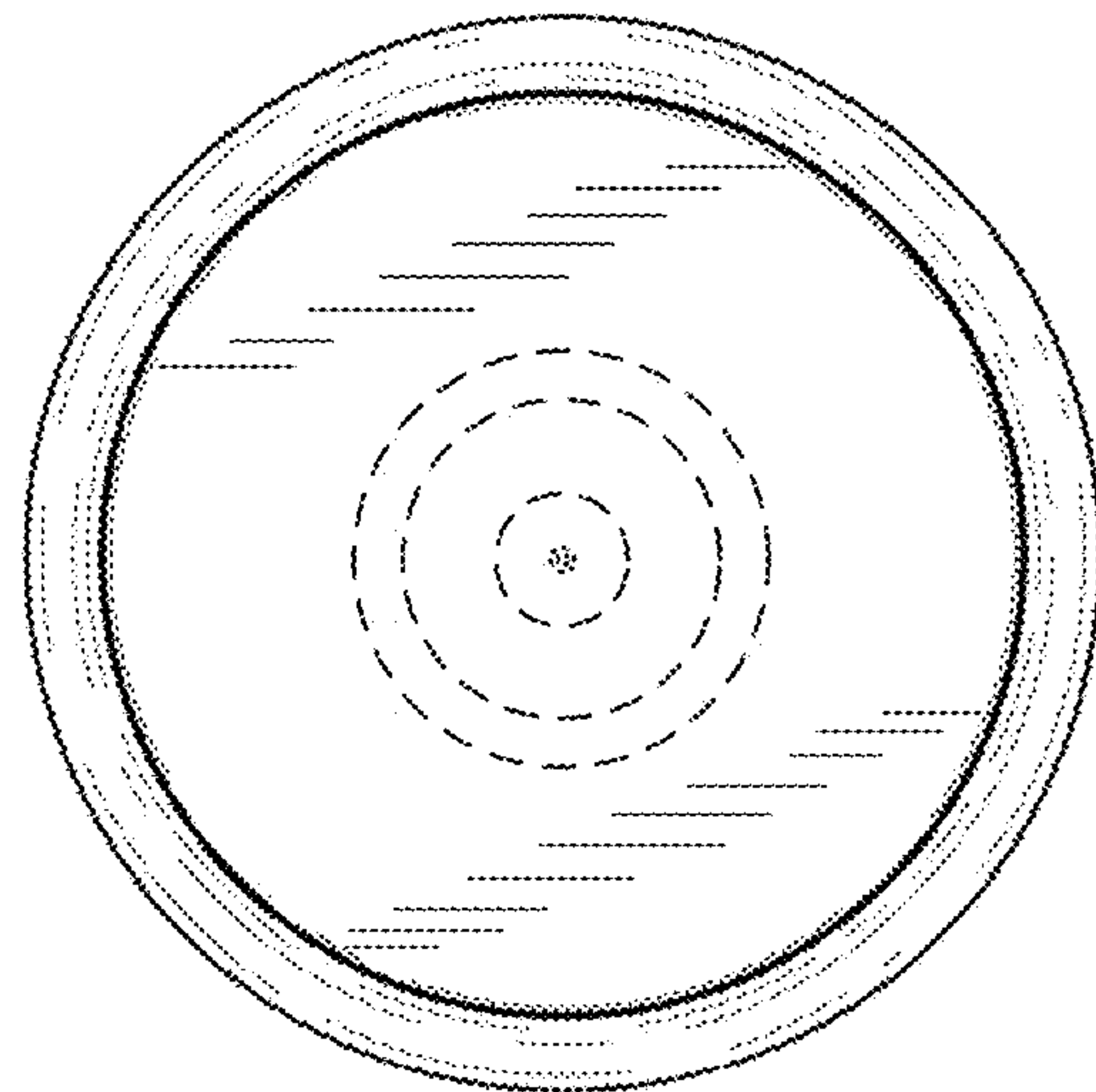

FIG. 11