



US00D969510S

(12) **United States Design Patent**  
**Zhao**

(10) **Patent No.:** **US D969,510 S**  
(45) **Date of Patent:** **\*\* Nov. 15, 2022**

(54) **MASSAGE CHAIR**  
(71) Applicant: **MASSAGE CHAIR MAX, INC.**,  
Atlanta, GA (US)  
(72) Inventor: **Sharp Zhao**, Atlanta, GA (US)  
(73) Assignee: **MASSAGE CHAIR MAX, INC.**,  
Atlanta, GA (US)

9,622,935 B2 \* 4/2017 Fukuyama ..... A61H 23/006  
D787,213 S \* 5/2017 Lek ..... D6/367  
D796,219 S \* 9/2017 Lin ..... D6/367  
D869,182 S \* 12/2019 Lin ..... D6/367

(Continued)

(\*\*) Term: **15 Years**

(21) Appl. No.: **29/836,793**

(22) Filed: **Apr. 29, 2022**

(51) **LOC (13) Cl.** ..... **06-01**

(52) **U.S. Cl.**  
USPC ..... **D6/367**

(58) **Field of Classification Search**  
USPC ..... D6/367, 371, 381  
CPC ..... A47C 1/02; A47C 1/0355; A47C 1/037;  
A47C 1/12; A47C 16/02; A47C 17/161;  
A47C 7/407; A47C 7/506; A47C 7/5068;  
A47C 7/52; A47C 7/566; A47C 7/68;  
A47C 7/624; A47C 7/725; A47C 1/0308;  
A47C 7/543; A61H 2201/0188; A61H  
2201/1623; A61H 2201/1676; A61H  
2201/5066; A61H 2201/1614; A61H  
2201/1238; A61H 2201/1671; A61H  
2201/0149; A61H 2201/1669; A61H  
2201/1215; A61H 2201/0192; A61H  
2205/06; A61H 2205/10; A61H 2205/081;  
A61H 2205/106; A61H 2205/108; A61H  
2205/062; A61H 2203/0431; A61H 7/00;  
A61H 7/007; A61H 23/006; A61H  
9/0078; A61H 2015/0014

See application file for complete search history.

(56) **References Cited**

**U.S. PATENT DOCUMENTS**

D653,468 S \* 2/2012 Hsieh ..... D6/367  
D705,562 S \* 5/2014 Ouchi ..... D6/367

**FOREIGN PATENT DOCUMENTS**

WO WO-2019088388 \* 9/2019 ..... A61H 15/00

*Primary Examiner* — Kevin K Rudzinski

*Assistant Examiner* — Paul D Bohannon

(74) *Attorney, Agent, or Firm* — Nitin Kaushik

(57) **CLAIM**

The ornamental design for a massage chair, as shown and described.

**DESCRIPTION**

FIG. 1 is a perspective view of a massage chair showing my new design;  
FIG. 2 is another perspective view thereof;  
FIG. 3 is a front elevational view thereof;  
FIG. 4 is a rear elevational view thereof;  
FIG. 5 is a left side elevational view thereof;  
FIG. 6 is a right side elevational view thereof;  
FIG. 7 is a top plan view thereof;  
FIG. 8 is a bottom plan view thereof;  
FIG. 9 is an enlarged view of portion 9 shown in FIG. 1;  
FIG. 10 is an enlarged view of portion 10 shown in FIG. 1;  
FIG. 11 is an enlarged view of portion 11 shown in FIG. 1;  
FIG. 12 is an enlarged view of portion 12 shown in FIG. 2;  
and,  
FIG. 13 is an enlarged view of portion 13 shown in FIG. 3.  
The dash-dash broken lines in the drawings depict portions of the massage chair that form no part of the claimed design. The dot-dash broken lines represent boundaries of the enlarged portions and form no part of the claimed design.

**1 Claim, 13 Drawing Sheets**

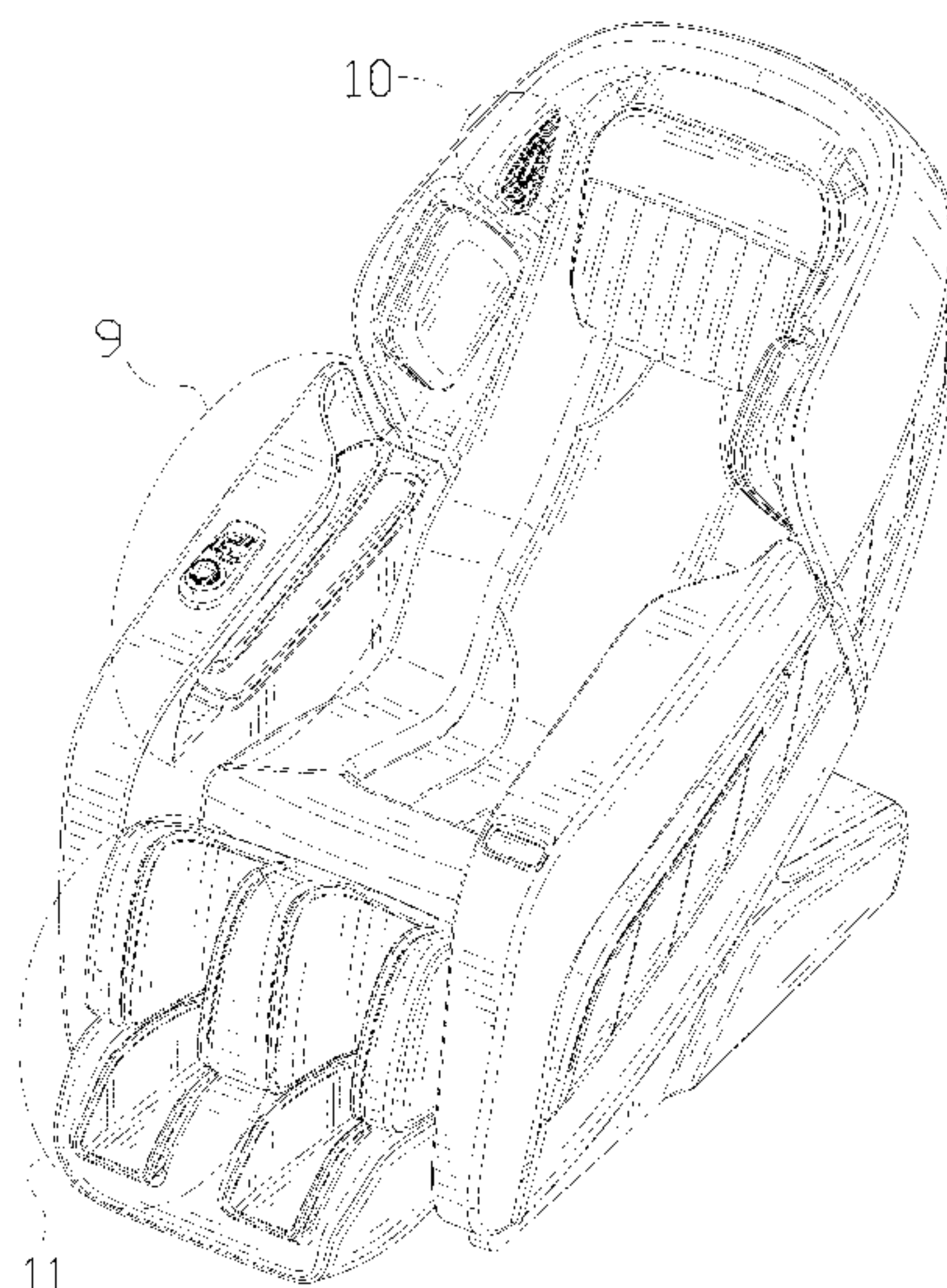

(56)

**References Cited**

U.S. PATENT DOCUMENTS

D874,838	S	2/2020	Potter	
D879,495	S	*	3/2020 Lee .....	D6/367
D887,741	S	*	6/2020 Okuyama .....	D6/367
D897,710	S	*	10/2020 Okuyama .....	D6/367
10,932,576	B2	*	3/2021 Levin .....	A61H 7/00
D923,351	S	*	6/2021 Lin .....	D6/367
D933,386	S	*	10/2021 Ker .....	D6/367

\* cited by examiner



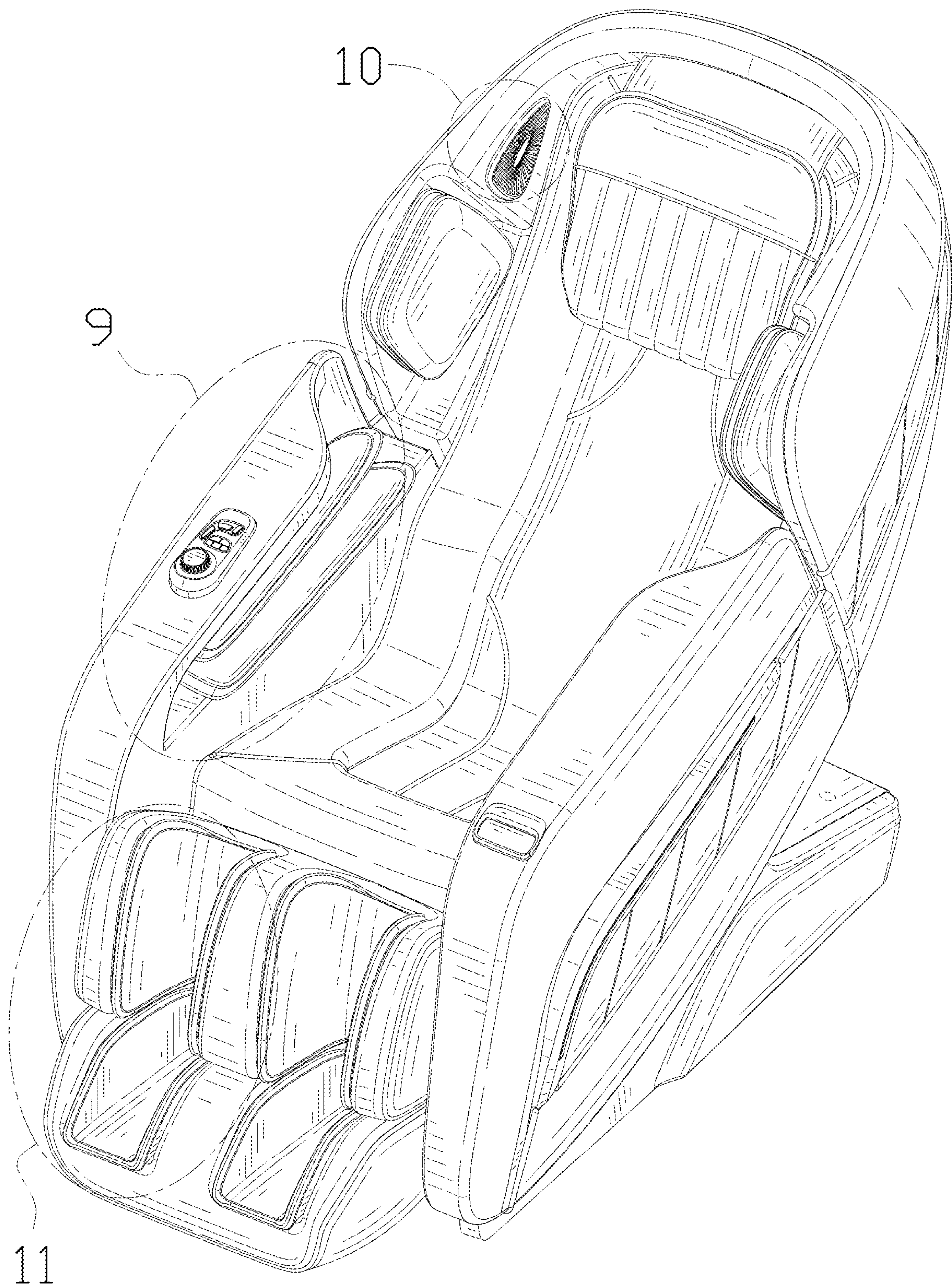

FIG. 1

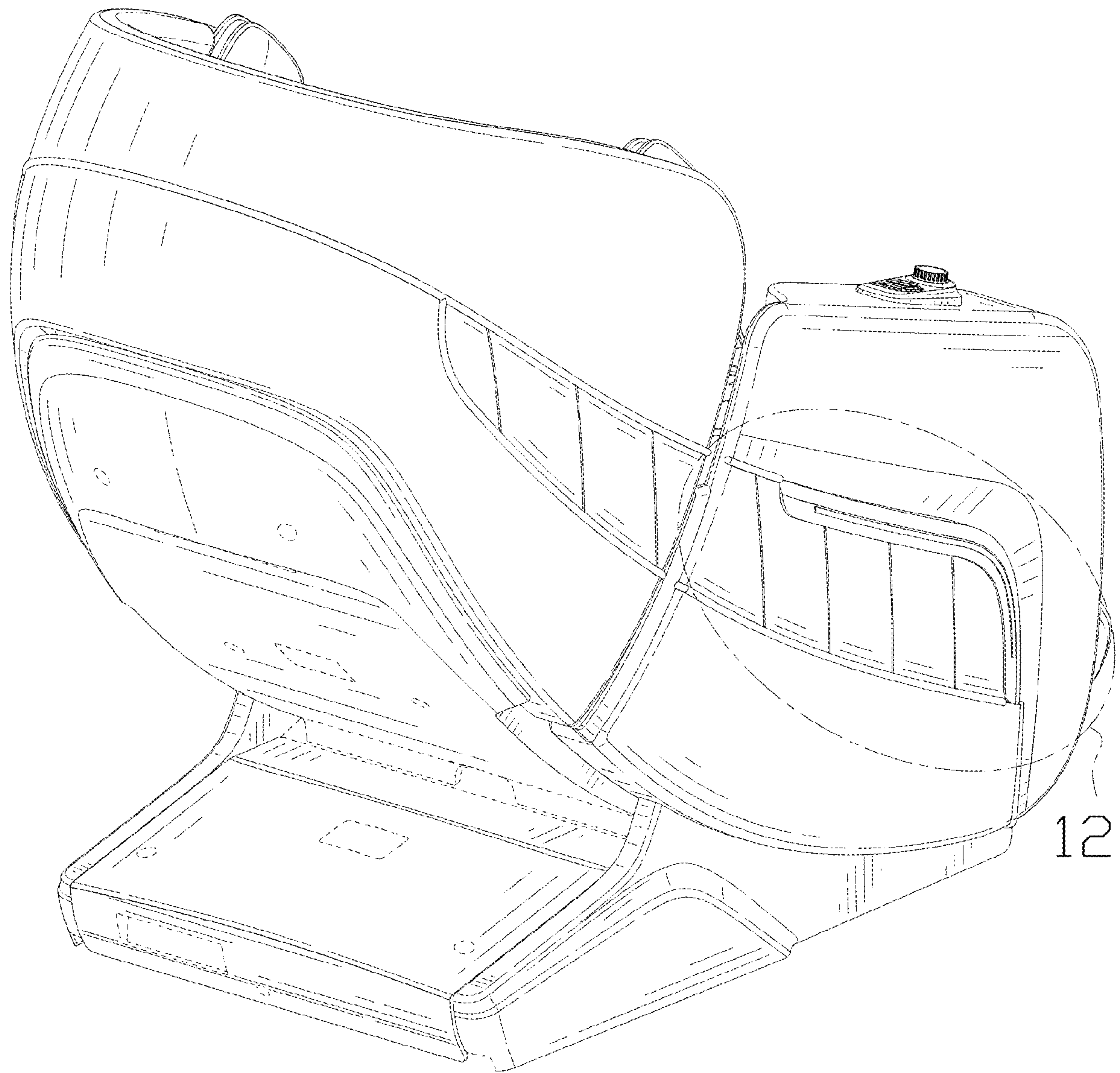

FIG. 2



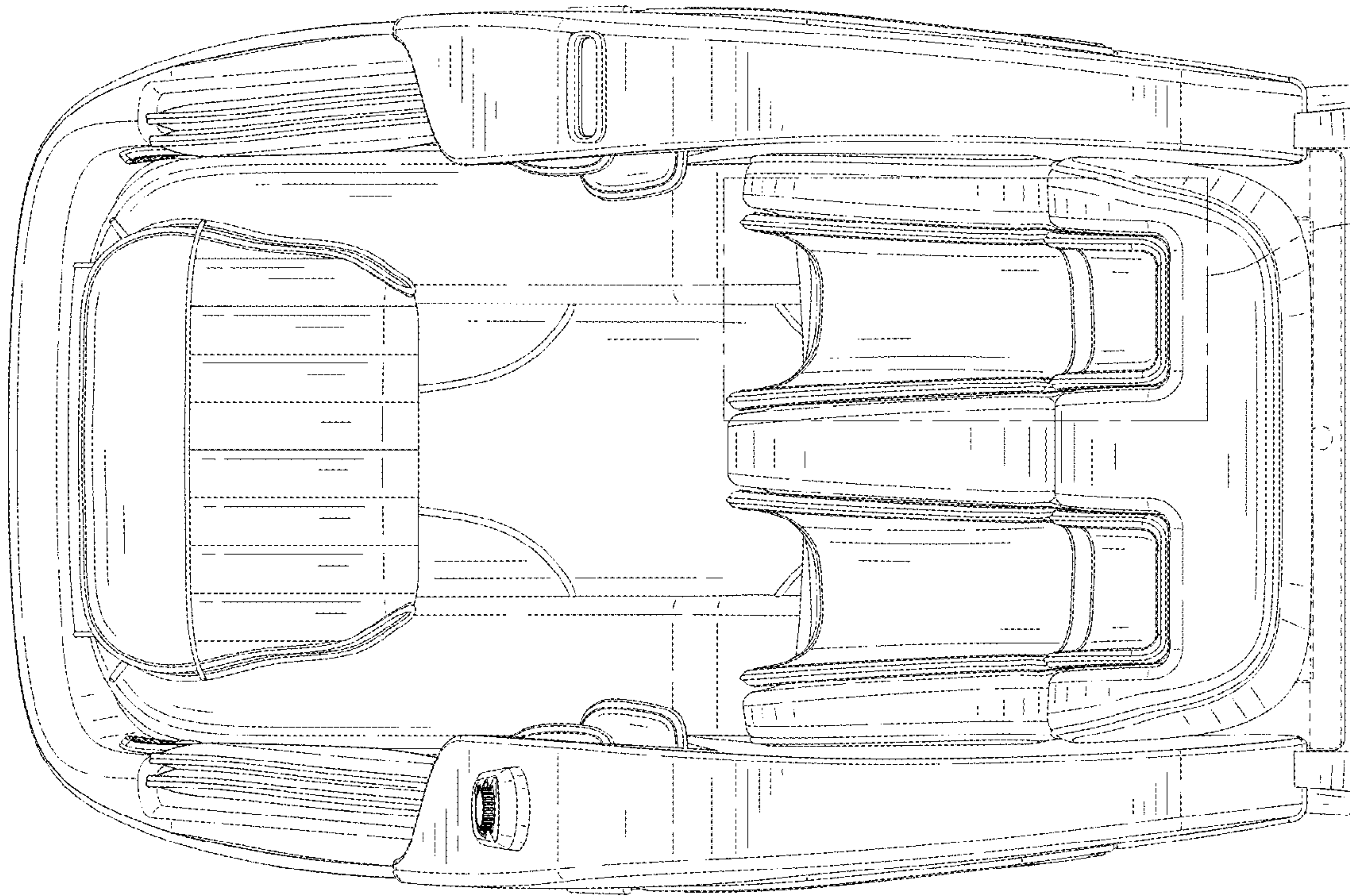

FIG. 3 13

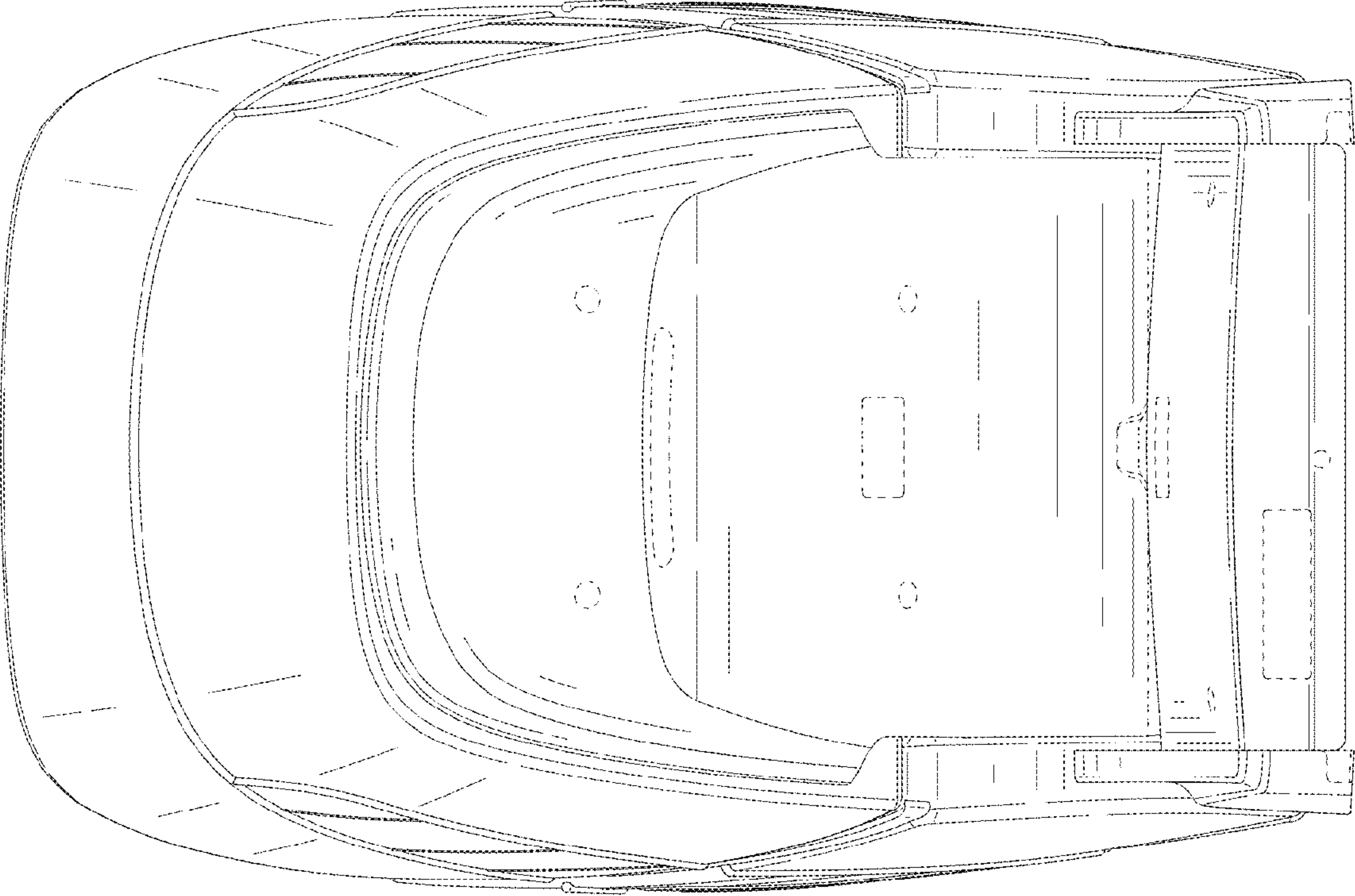

FIG. 4

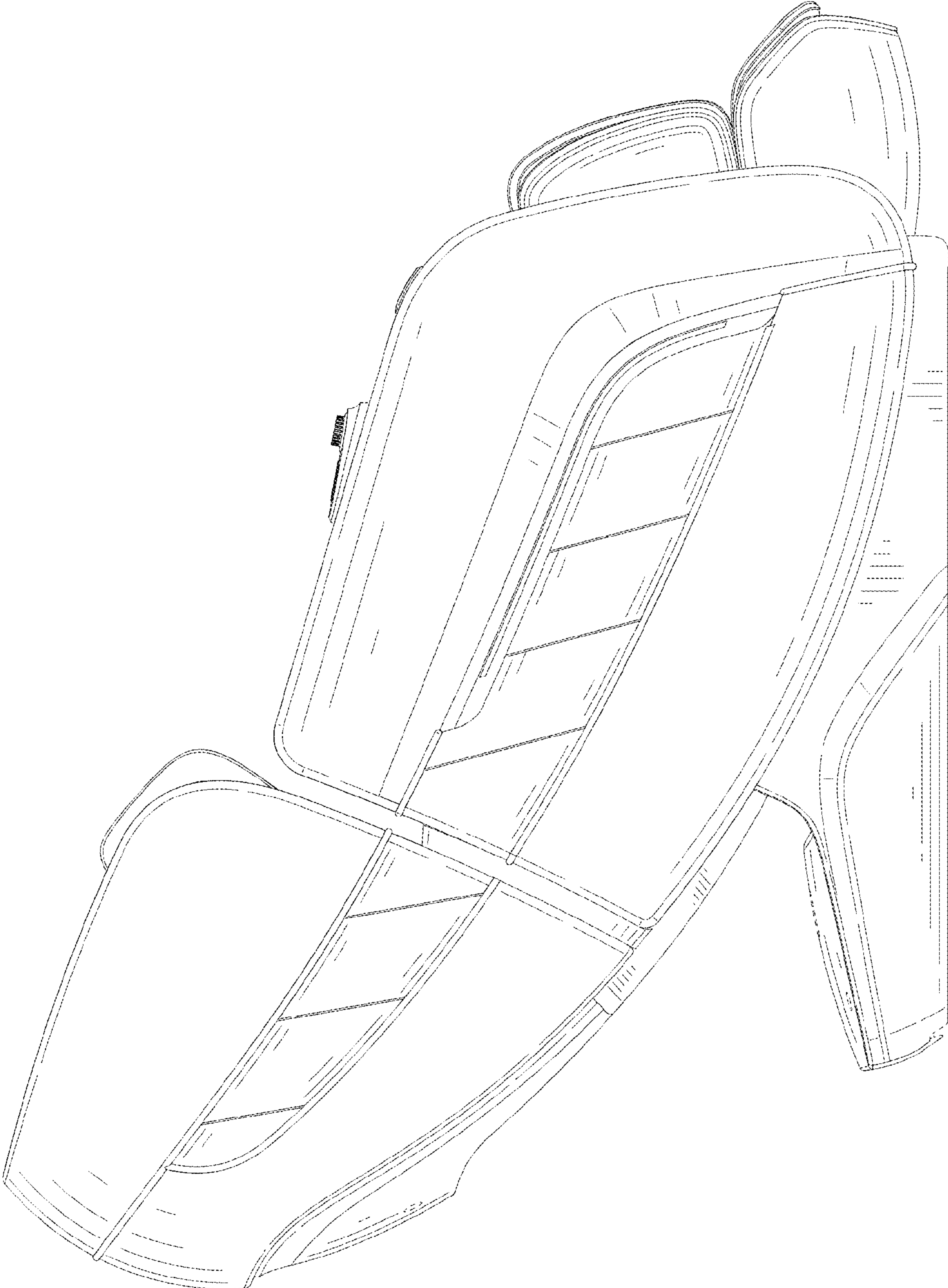

FIG. 5

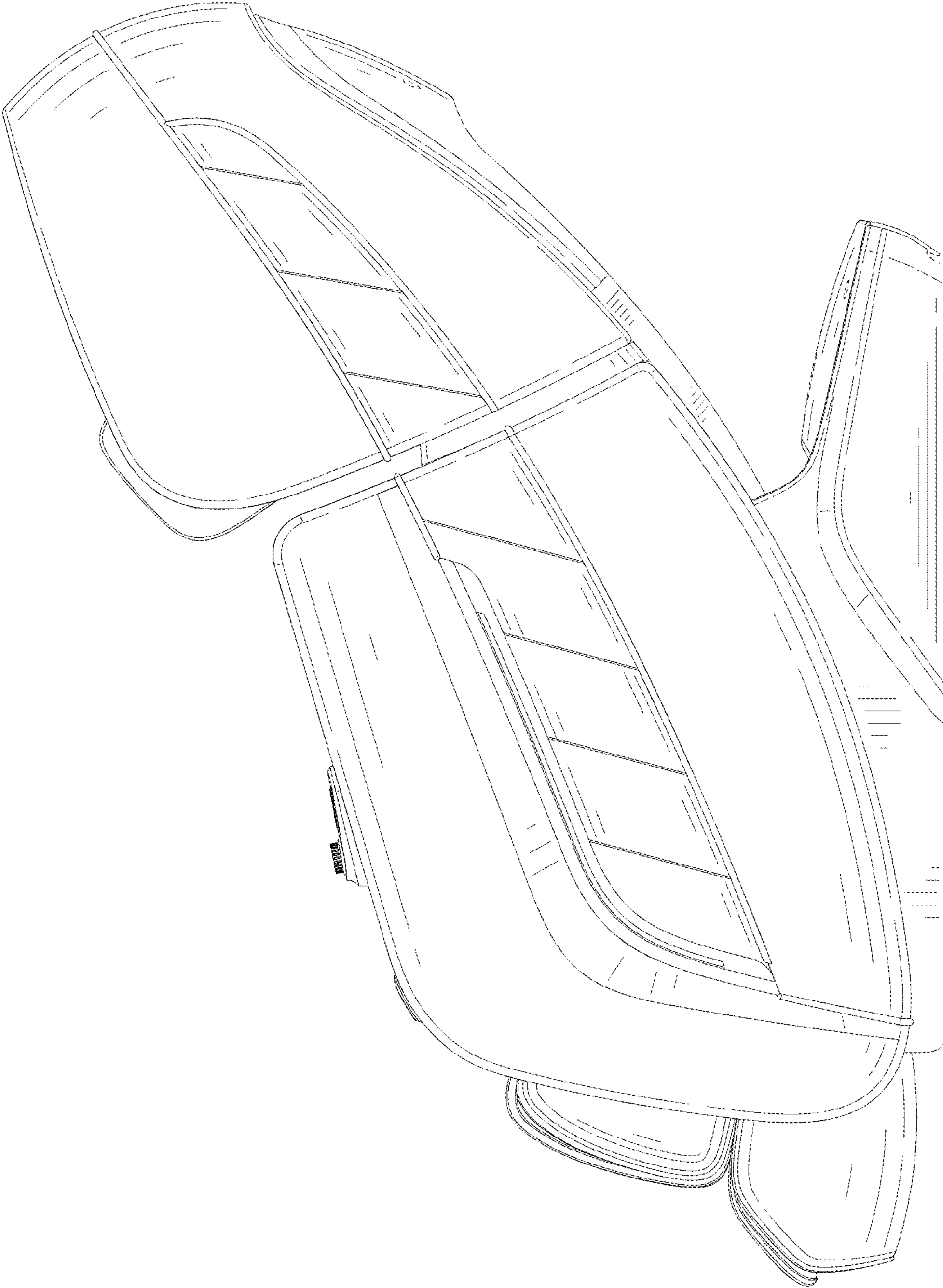

FIG. 6



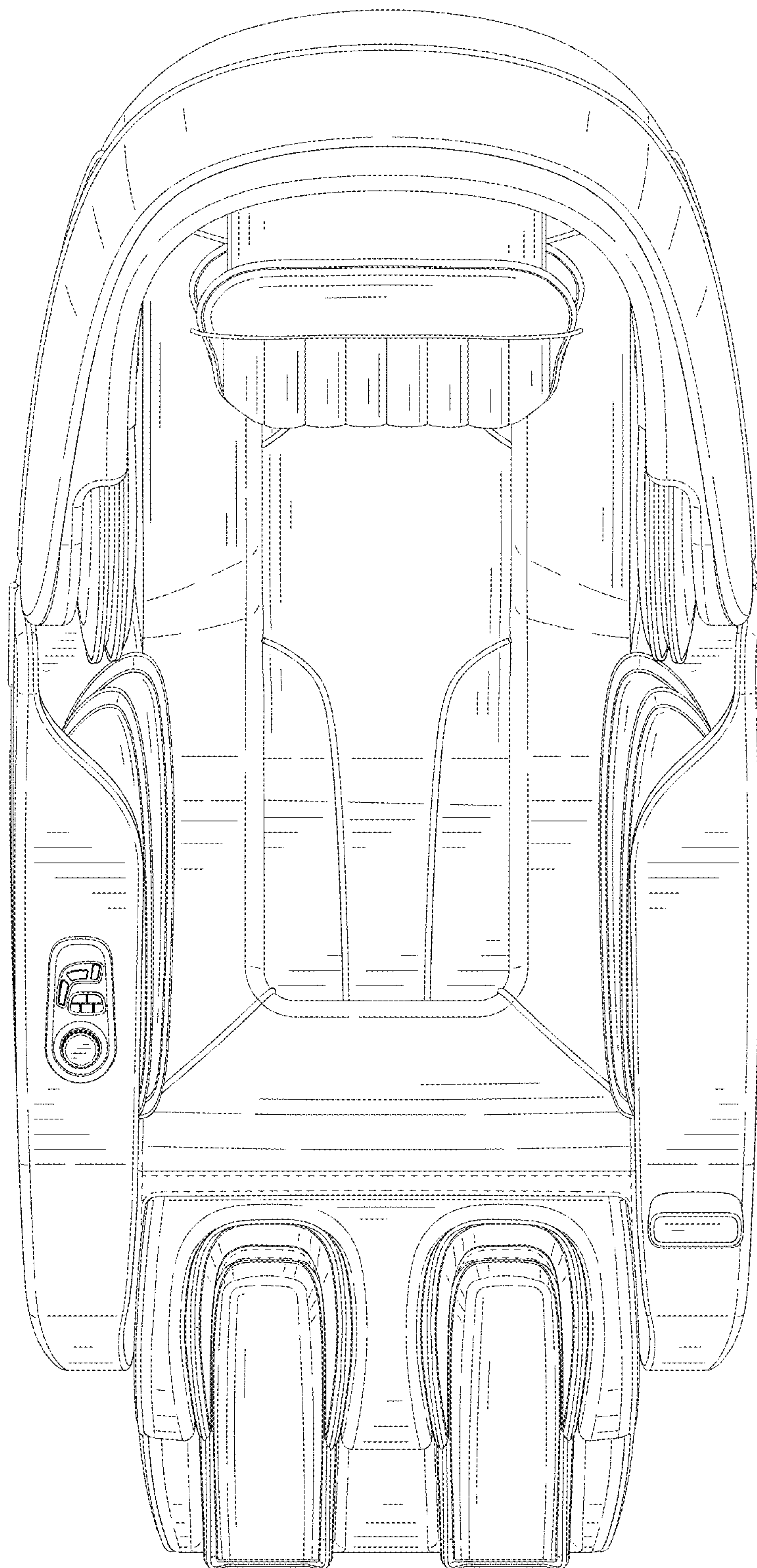

FIG. 7

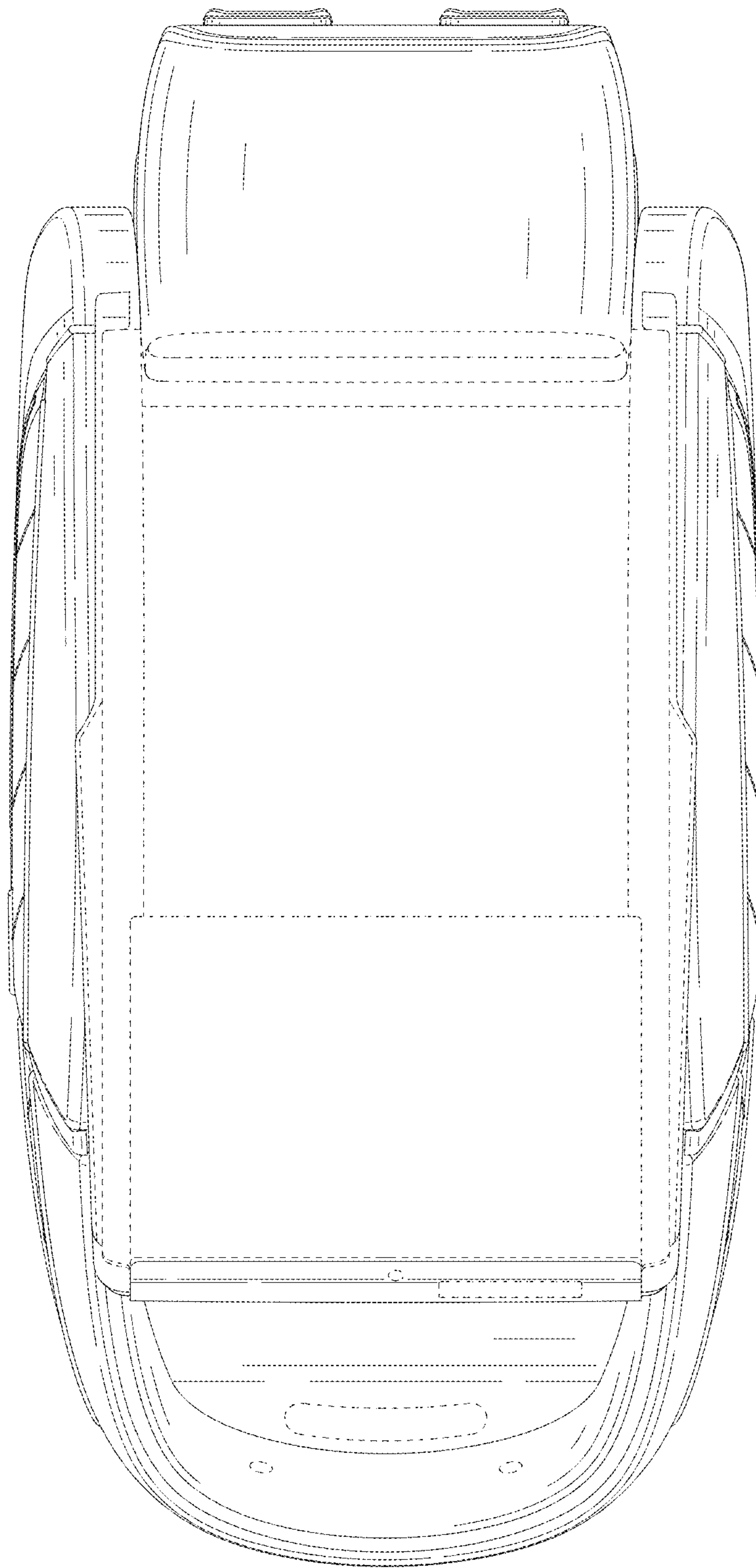

FIG. 8

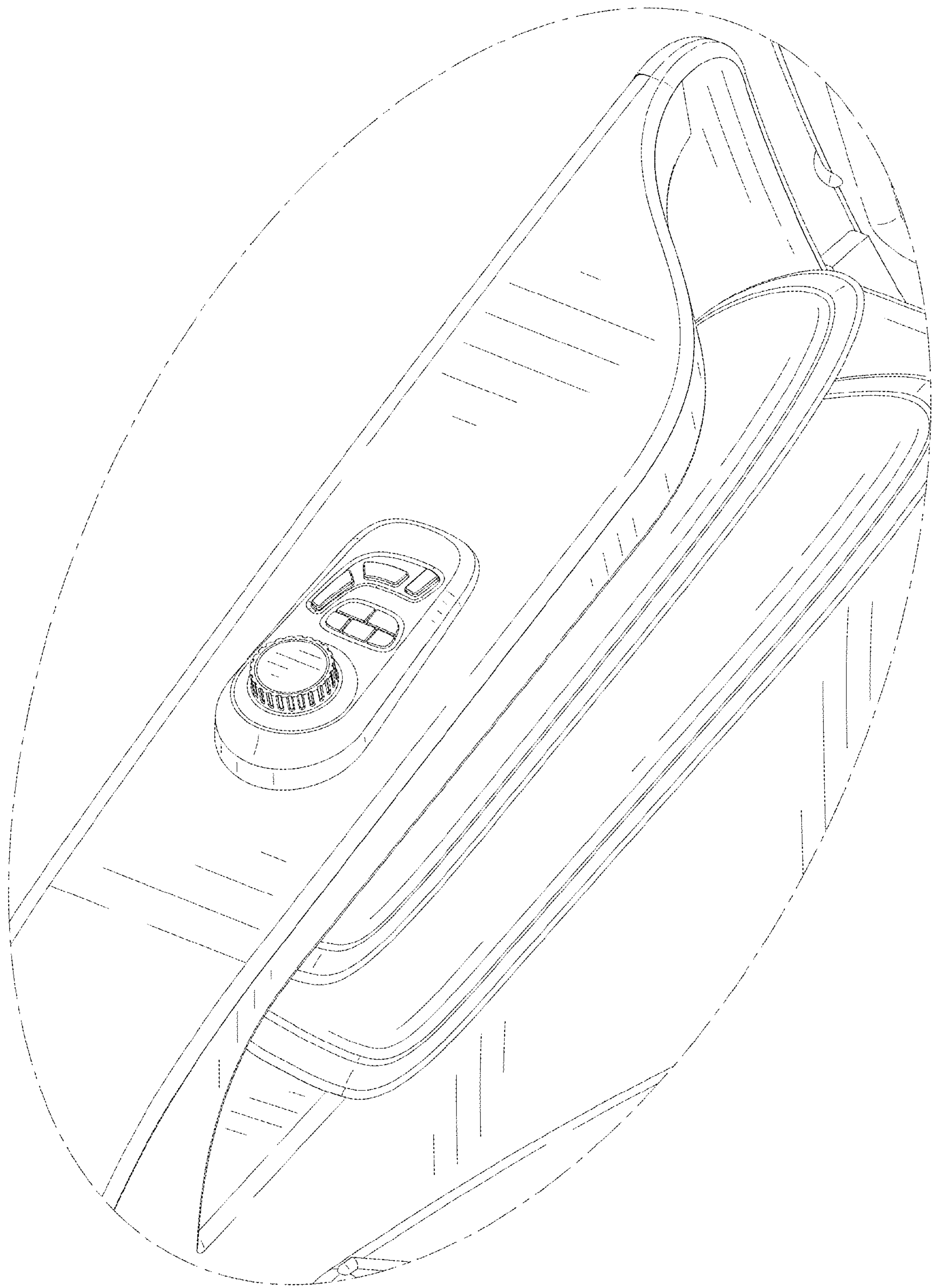

FIG. 9



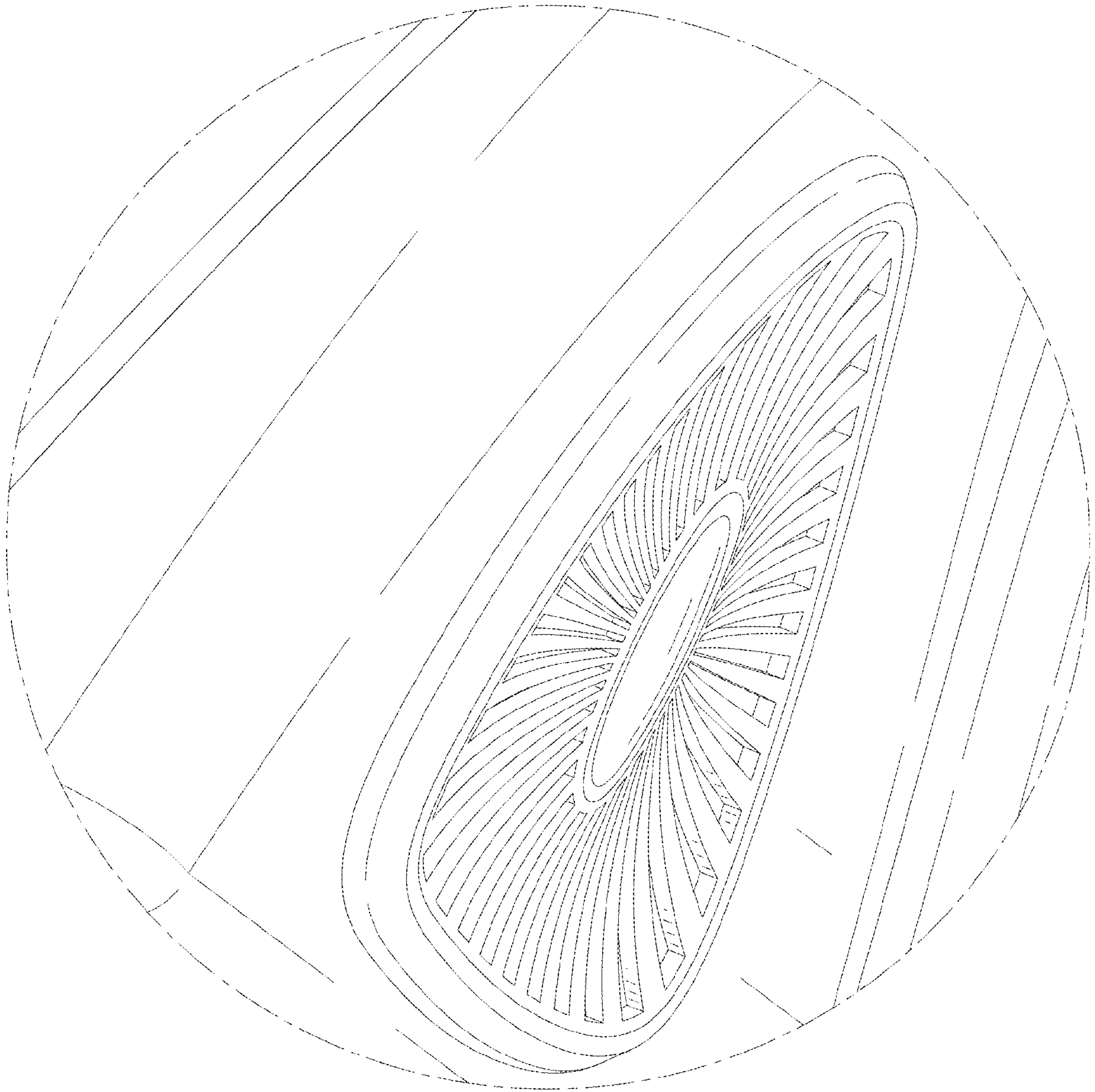

FIG. 10

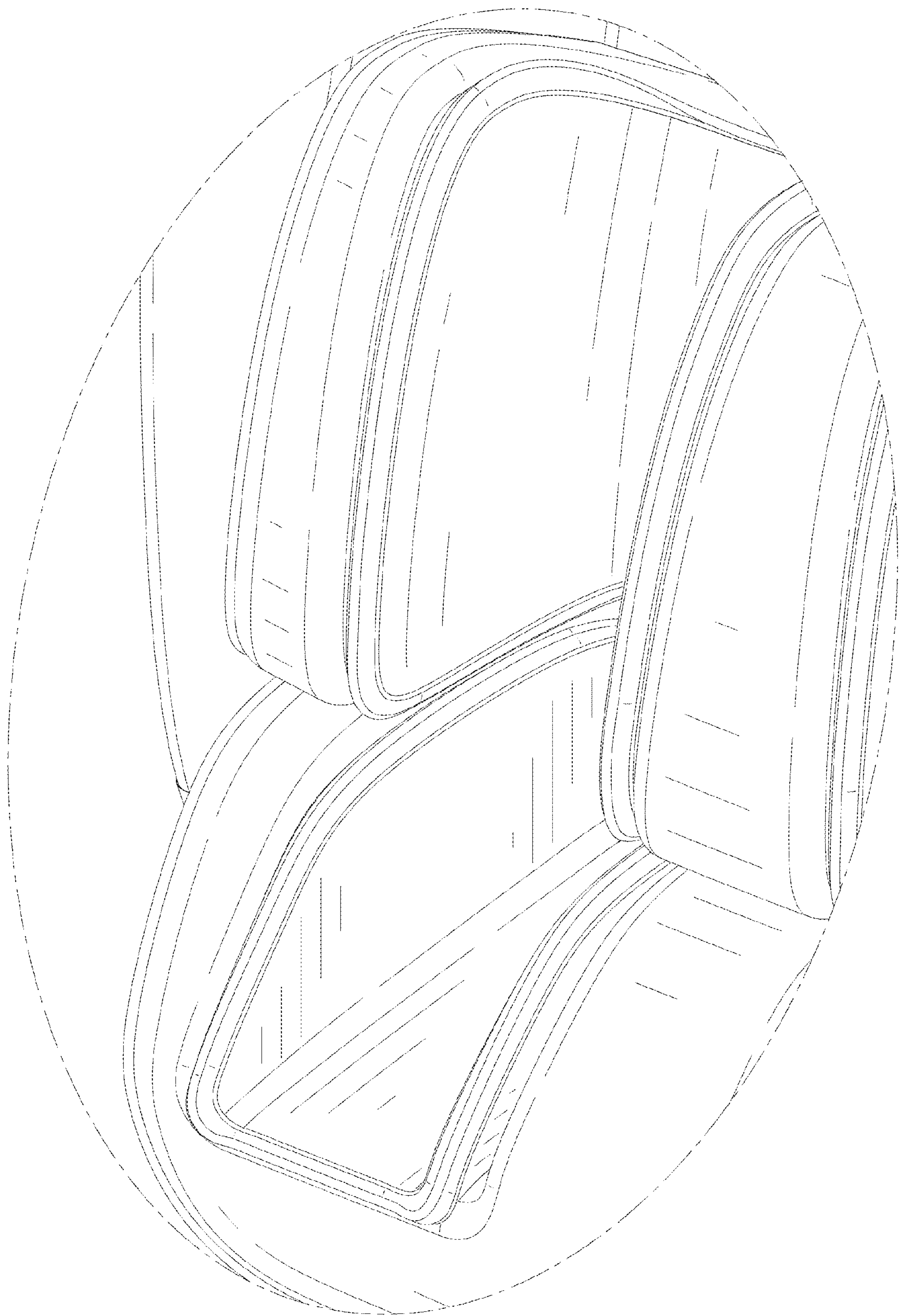

FIG. 11

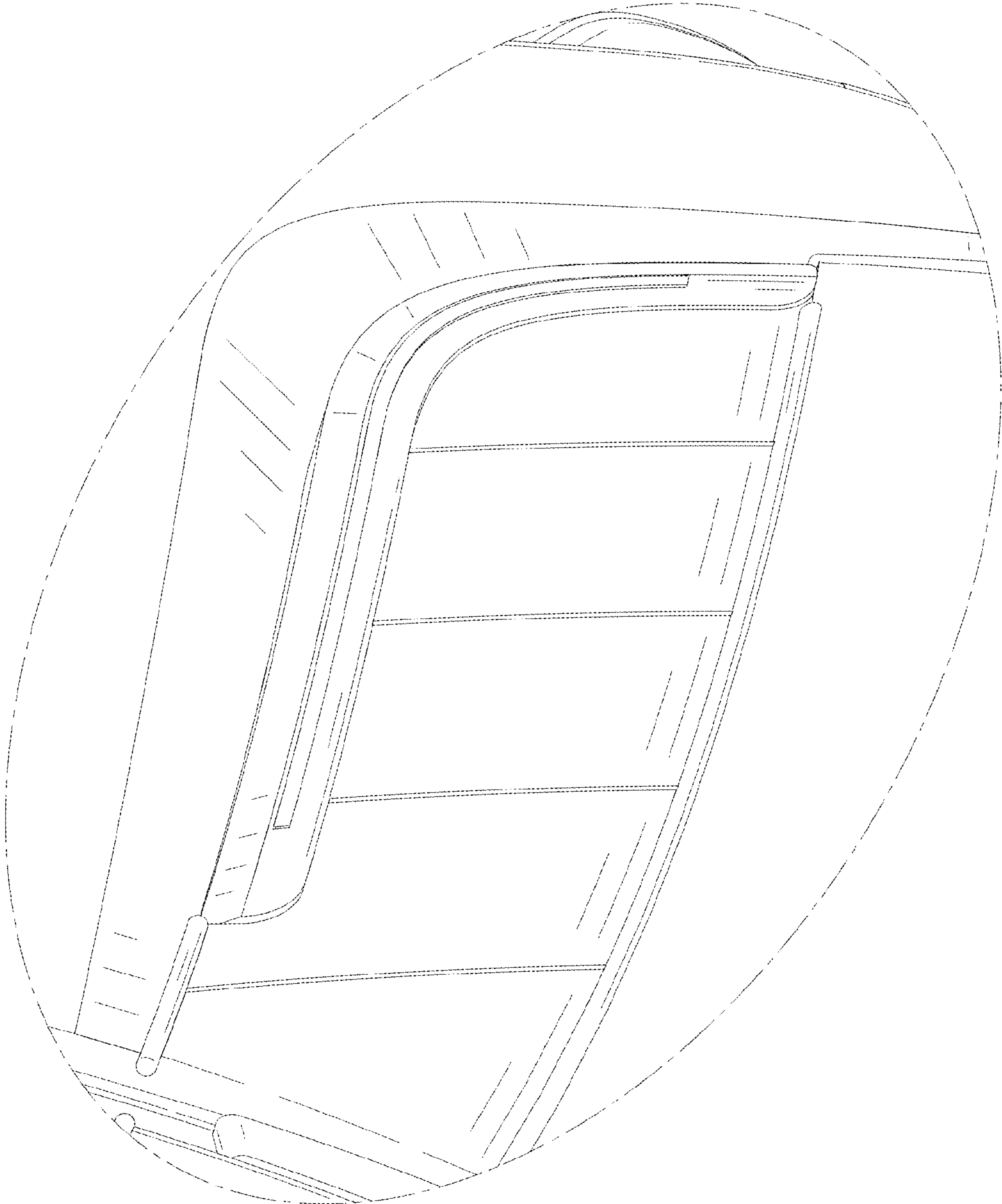

FIG. 12



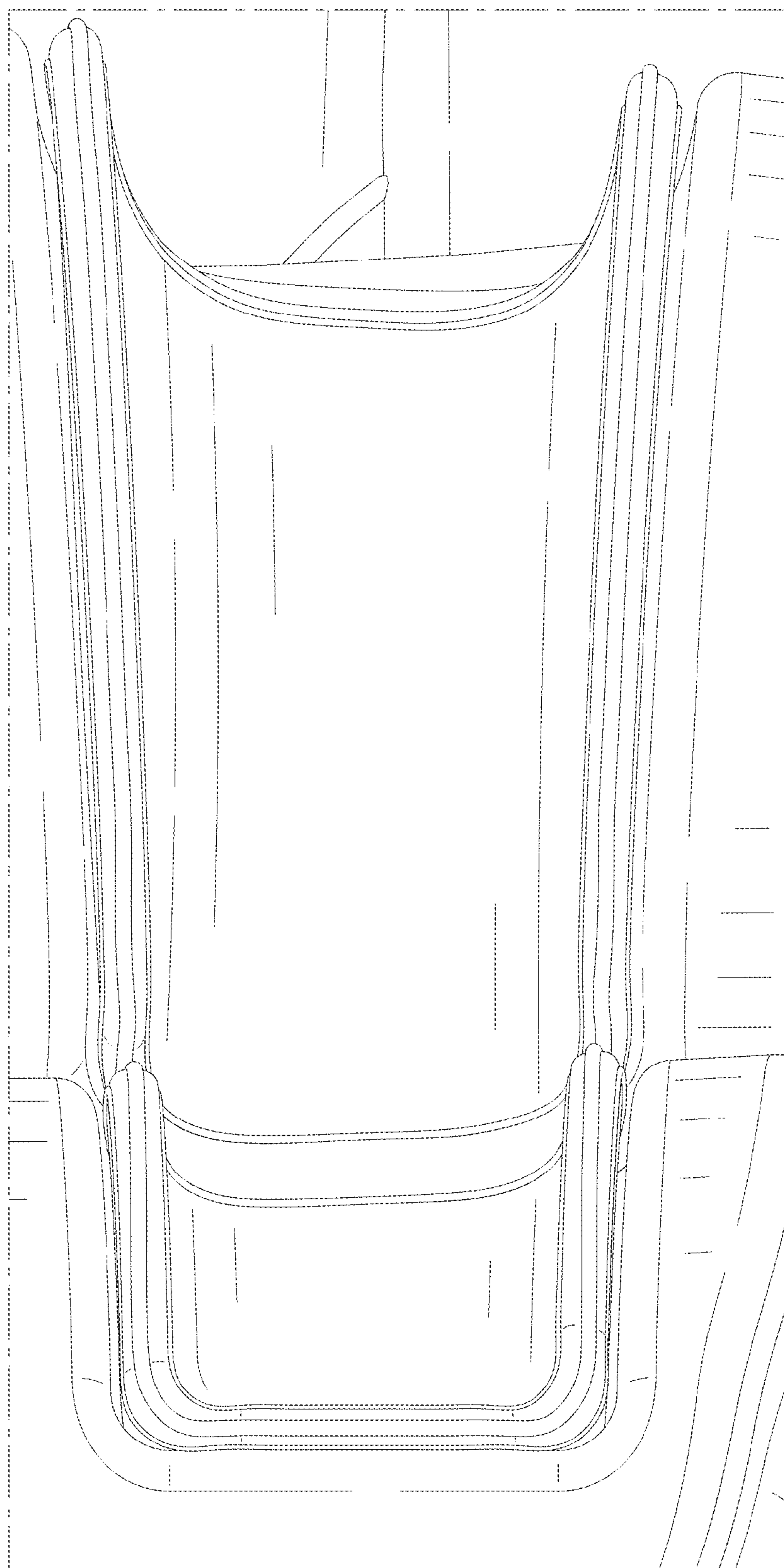

FIG. 13