



US00D969420S

(12) **United States Design Patent** (10) **Patent No.:** **US D969,420 S**  
**Vilbert** (45) **Date of Patent:** **\*\* \*Nov. 8, 2022**

(54) **COLLAR FOR ANIMALS**

(71) Applicant: **AB7 SANTE**, Deyme (FR)

(72) Inventor: **Arnaud Vilbert**, Baziege (FR)

(\*) Notice: This patent is subject to a terminal disclaimer.

(\*\*) Term: **15 Years**

(21) Appl. No.: **35/509,655**

(22) Filed: **Oct. 30, 2019**

(80) **Hague Agreement Data**

Int. Filing Date: **Oct. 30, 2019**

Int. Reg. No.: **DM/208620**

Int. Reg. Date: **Oct. 30, 2019**

Int. Reg. Pub. Date: **Jun. 19, 2020**

(51) **LOC (13) Cl.** ..... **30-04**

(52) **U.S. Cl.**  
USPC ..... **D30/152**

(58) **Field of Classification Search**  
USPC ..... D30/151, 152, 155, 199; D10/32, 104.1,  
D10/104.2; D11/208, 218; D2/628, 894,  
D2/895; D24/190

CPC ..... A01K 27/001  
See application file for complete search history.

(56) **References Cited**

**U.S. PATENT DOCUMENTS**

- D322,871 S \* 12/1991 Heyman ..... D30/152
- 5,271,354 A \* 12/1993 Barnett ..... A01K 27/007  
119/654
- 5,555,848 A \* 9/1996 Trujillo ..... A01K 27/007  
119/654
- D473,483 S \* 4/2003 Hardy ..... D11/3
- D708,794 S \* 7/2014 Monsalve ..... D30/152
- D720,248 S \* 12/2014 Law ..... D11/3
- D799,758 S \* 10/2017 Yohai-Giochais ..... D30/152
- D852,437 S \* 6/2019 Chelle ..... D30/152

- D903,952 S \* 12/2020 Oliveira ..... D30/152
- 2006/0144345 A1 \* 7/2006 Kover, Jr. .... A01K 27/006  
119/865
- 2007/0034165 A1 \* 2/2007 Yang ..... A01K 27/009  
119/863
- 2007/0204811 A1 \* 9/2007 Agee ..... A01K 27/009  
119/860
- 2020/0315139 A1 \* 10/2020 Chelle ..... A01K 27/007

**OTHER PUBLICATIONS**

“Calm Paws: Calming Collar”. Found online Apr. 12, 2021 at facebook.com. Reference dated Jul. 3, 2017. Retrieved from [https://www.facebook.com/calmpaws/photos/a.874918525972514/1097318893732475/?type=3&theater.\\*](https://www.facebook.com/calmpaws/photos/a.874918525972514/1097318893732475/?type=3&theater.*)

“Disane: 100% Natural Flea Collar”. Found online Apr. 12, 2021 at amazon.co.uk. Reference dated Apr. 10, 2019. Retrieved from [https://www.amazon.co.uk/DISANE-Protection-Formulated-Veterinary-Adjustable/dp/B079V1845R/ref=sr\\_1\\_131?.\\*](https://www.amazon.co.uk/DISANE-Protection-Formulated-Veterinary-Adjustable/dp/B079V1845R/ref=sr_1_131?.*)

(Continued)

*Primary Examiner* — Kendra Leslie Hamilton

(74) *Attorney, Agent, or Firm* — Benoit & Côté Inc.

(57) **CLAIM**

The ornamental design for collar for animals, as shown and described.

**DESCRIPTION**

- 1.1 is a front view of a collar for animals showing my new design;
  - 1.2 is a left side view of the collar for animals;
  - 1.3 is a top view of the collar for animals;
  - 1.4 is a bottom view of the collar for animals;
  - 1.5 is a first perspective view of the collar for animals;
  - 1.6 is a second perspective view of the collar for animals; and
  - 1.7 is a third perspective view of the collar for animals.
- In the reproductions, the equal-length broken lines that show a leaf pattern depict portions of the collar for animals that form no part of the claimed design.

**1 Claim, 7 Drawing Sheets**

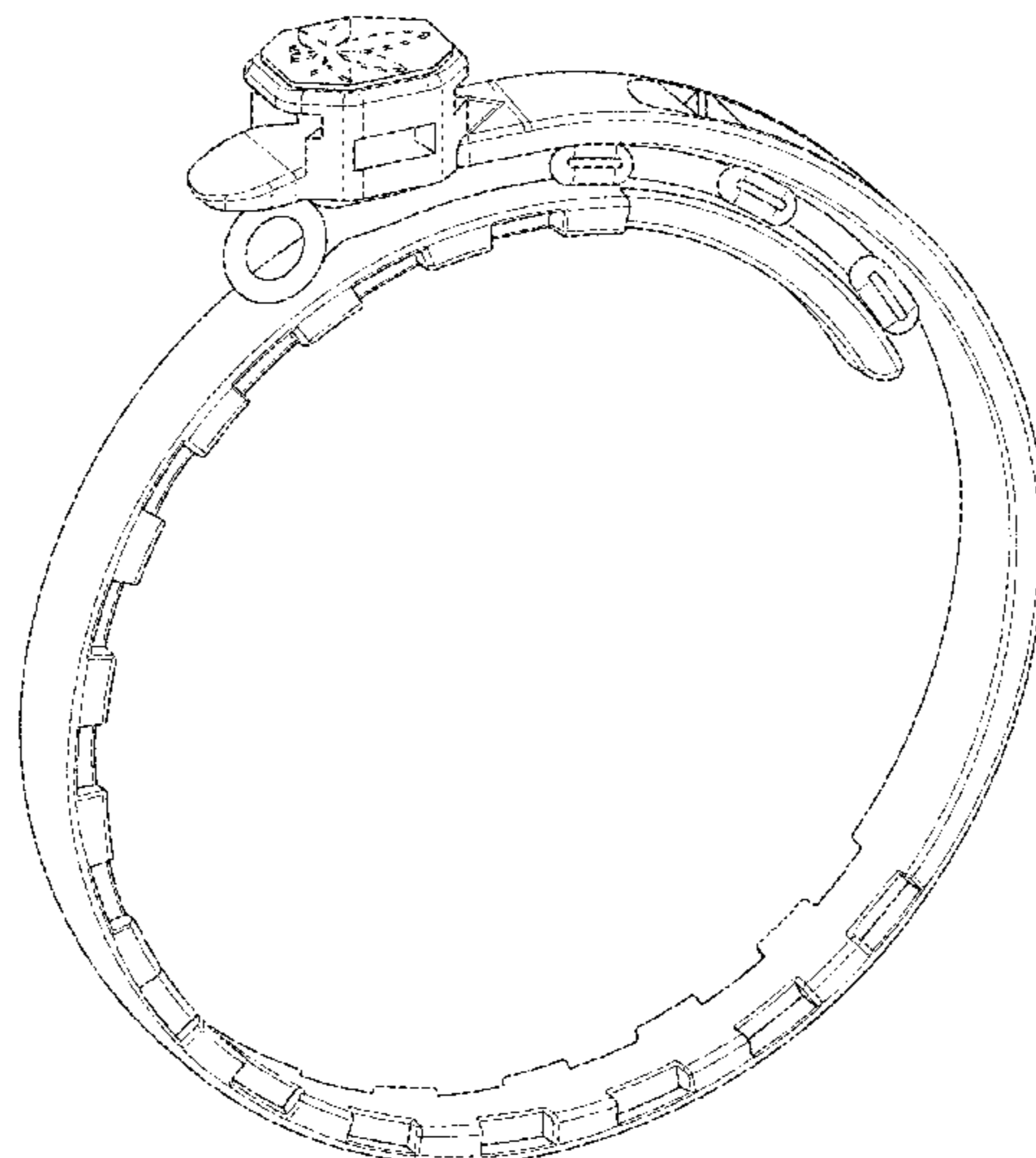

(56)

**References Cited**

OTHER PUBLICATIONS

“Pride & Groom: Flea & Tick Collar”. Found online Apr. 12, 2021 at amazon.co.uk. Reference dated Feb. 1, 2018. Retrieved from [https://www.amazon.co.uk/Pride-Groom-Universal-Treatment-Kitten/dp/B079HX93PY/ref=sr\\_1\\_147?](https://www.amazon.co.uk/Pride-Groom-Universal-Treatment-Kitten/dp/B079HX93PY/ref=sr_1_147?).\*

“Seresto Flea and Tick Collar”. Found online Apr. 12, 2021 at amazon.com. Reference dated Apr. 3, 2015. Retrieved from [https://www.amazon.com/Bayer-Seresto-Collar-Large-2-Pack/dp/B00WMMMHNM/ref=sr\\_1\\_3?](https://www.amazon.com/Bayer-Seresto-Collar-Large-2-Pack/dp/B00WMMMHNM/ref=sr_1_3?).\*

\* cited by examiner

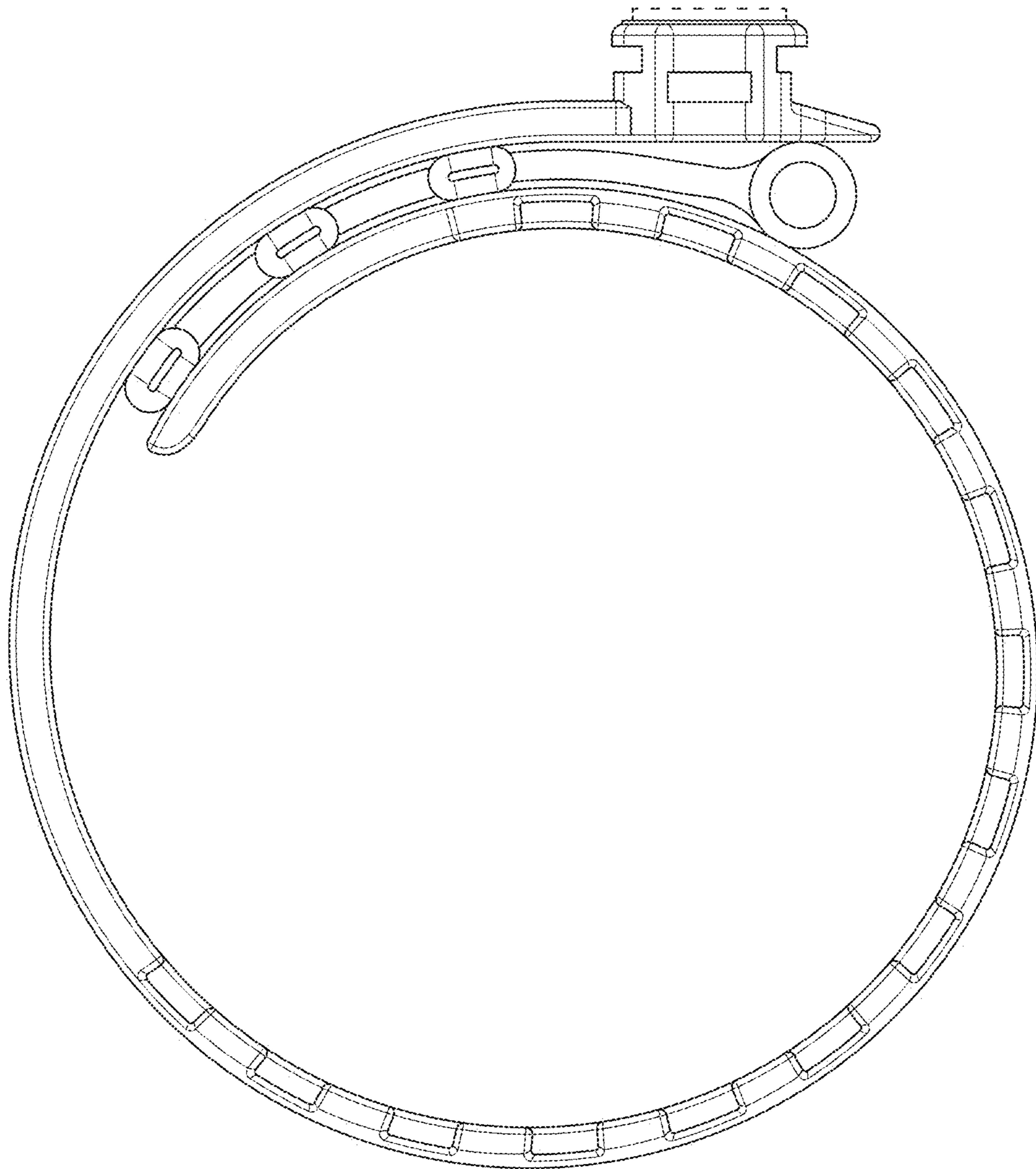

1.1

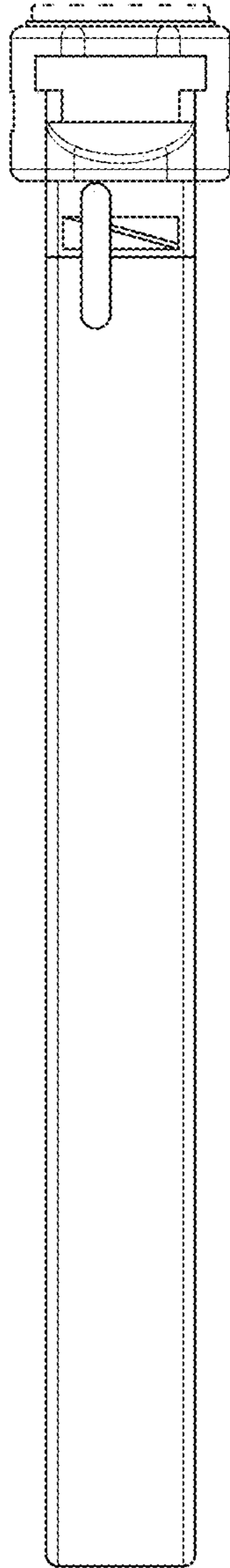

1.2

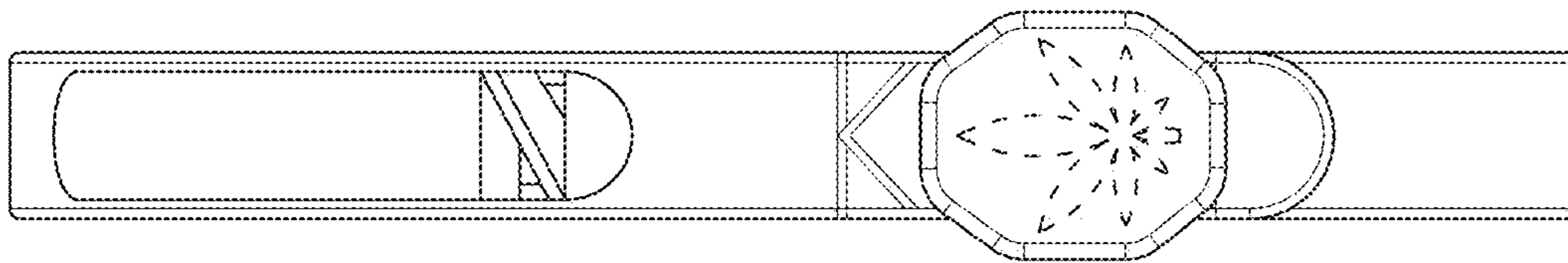

1.3

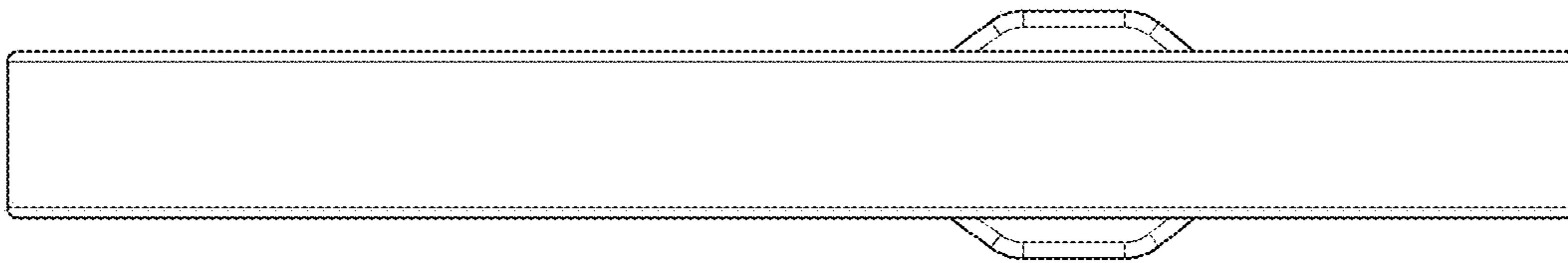

1.4

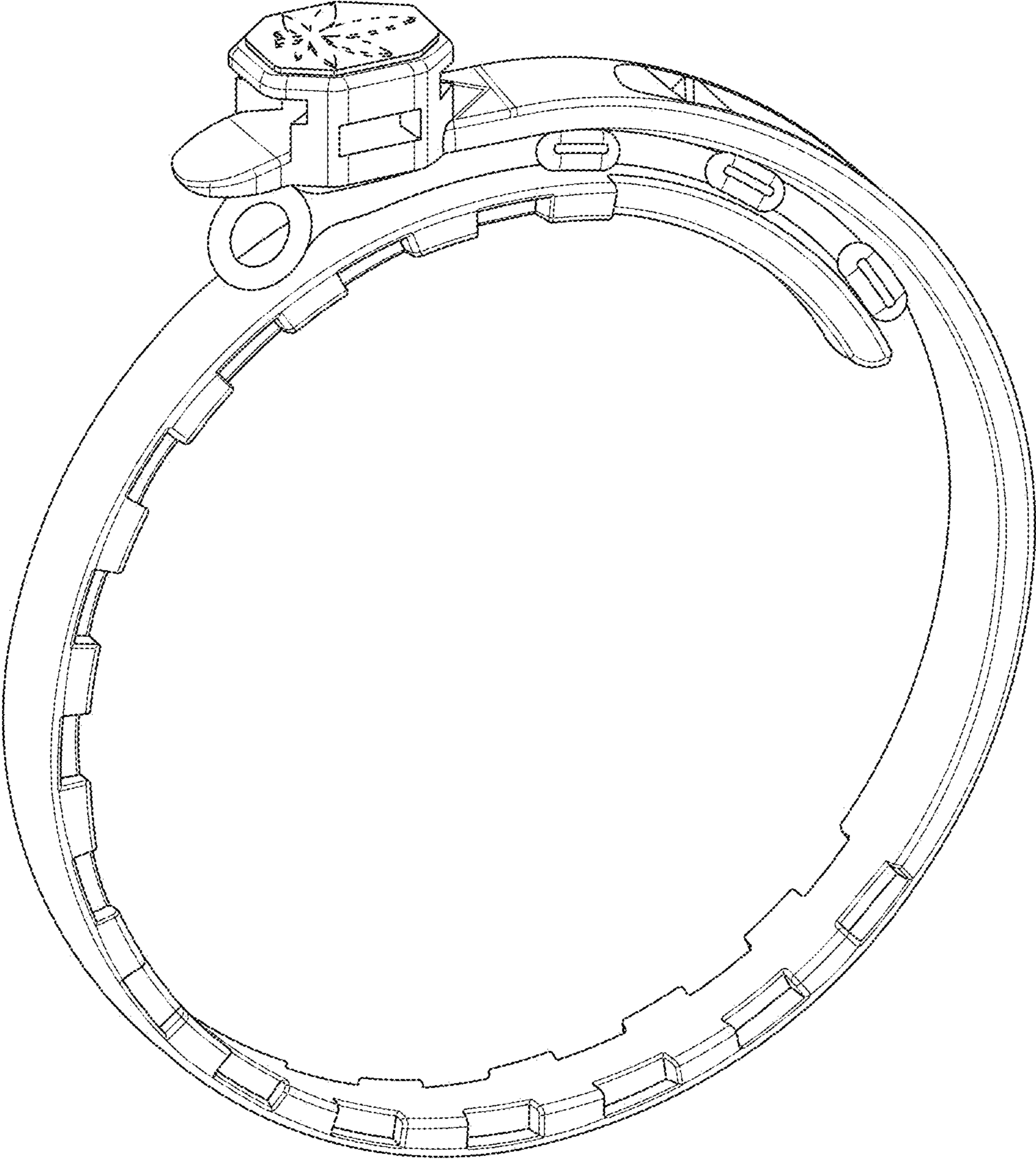

1.5

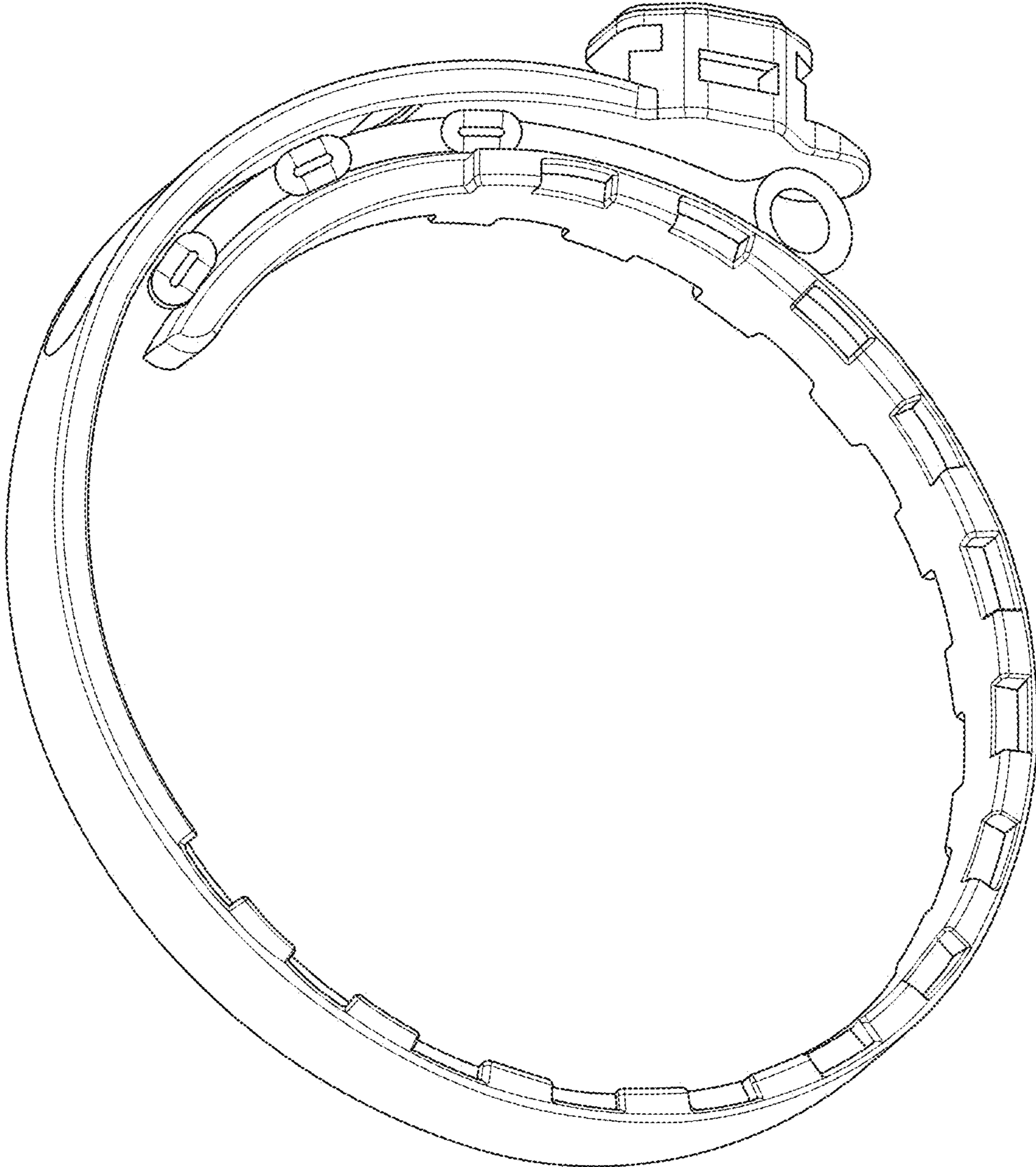

1.6



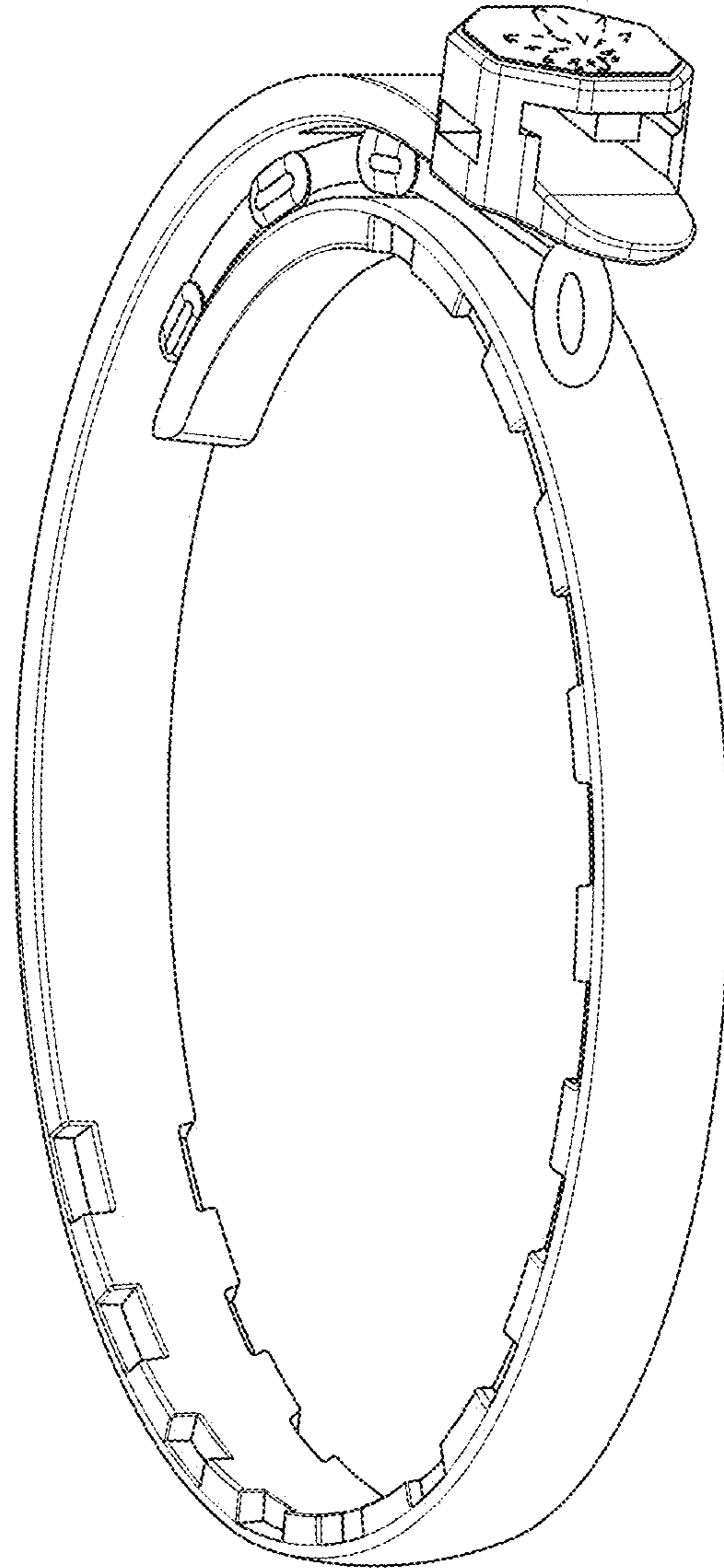

1.7