

US00D969317S

(12) **United States Design Patent**
Sun et al.

(10) **Patent No.:** **US D969,317 S**
(45) **Date of Patent:** **** Nov. 8, 2022**

(54) **HANDHELD SURGICAL INSTRUMENT**

(56) **References Cited**

(71) Applicant: **Ezisurg Medical Co., Ltd.**, Shanghai (CN)

U.S. PATENT DOCUMENTS

(72) Inventors: **Min Sun**, Shanghai (CN); **Jidong Chen**, Shanghai (CN); **Honglin Nie**, Shanghai (CN)

D259,392 S *	6/1981	Elmessaar	D8/68
D299,411 S *	1/1989	Porcaro	D8/68
D342,878 S *	1/1994	Watanabe	D8/68
D347,474 S *	5/1994	Olson	D24/145
D348,930 S *	7/1994	Olson	D24/145
D349,341 S *	8/1994	Lichtman	D24/143

(73) Assignee: **EZISURG MEDICAL CO., LTD.**, Shanghai (CN)

(Continued)

(**) Term: **15 Years**

OTHER PUBLICATIONS

(21) Appl. No.: **29/691,646**

Universal Linear Cutting Stapler,[site visited Sep. 22, 2021]. Available from Internet. URL: en.ezisurg.com/index.php?id=7 (Year: 2021).*

(22) Filed: **May 17, 2019**

Primary Examiner — T Chase Nelson

Assistant Examiner — Kelly L Gross

(30) **Foreign Application Priority Data**

Nov. 21, 2018 (CN) 201830663907.5

(74) *Attorney, Agent, or Firm* — Venable LLP

(51) **LOC (13) Cl.** **24-02**

(57) **CLAIM**

(52) **U.S. Cl.**
USPC **D24/133**

The ornamental design for a handheld surgical instrument, as shown and described.

(58) **Field of Classification Search**

USPC D24/119, 133, 137, 138, 151, 146, 147, D24/152, 108, 111, 112, 113, 117, 118, D24/127, 130, 135, 141, 143, 144, 148, D24/153, 154, 170, 176, 179, 216, 222, D24/145; D8/51, 68, 107

CPC A61B 1/00; A61B 1/00137; A61B 1/005; A61B 1/0014; A61B 1/0676; A61B 1/0669; A61B 1/00121; A61B 1/00133; A61B 1/00071; A61B 1/00064; A61B 1/00068; A61B 1/00112; A61B 1/0125; A61B 17/3478; A61B 17/0684; A61B 17/068; A61B 17/0469; A61B 17/320092; A61B 17/32; A61B 18/1445; A61B 1/00087; A61B 1/00098; A61B 1/0052; A61B 1/00101; A61B 1/00066; A61B 1/0057; A61B 1/0011; A61M 25/09

See application file for complete search history.

DESCRIPTION

FIG. 1 is a left view of an embodiment of a handheld surgical instrument;
 FIG. 2 is a right view of the handheld surgical instrument;
 FIG. 3 is a front side view of the handheld surgical instrument, the back side view is a mirror image of the front side view, and thus the back side view is omitted;
 FIG. 4 is a top view of the handheld surgical instrument;
 FIG. 5 is a bottom view of the handheld surgical instrument;
 and,
 FIG. 6 is a perspective of the handheld surgical instrument. The broken lines in the drawings show portions of the handheld surgical instrument that form no part of the claimed design.

1 Claim, 6 Drawing Sheets

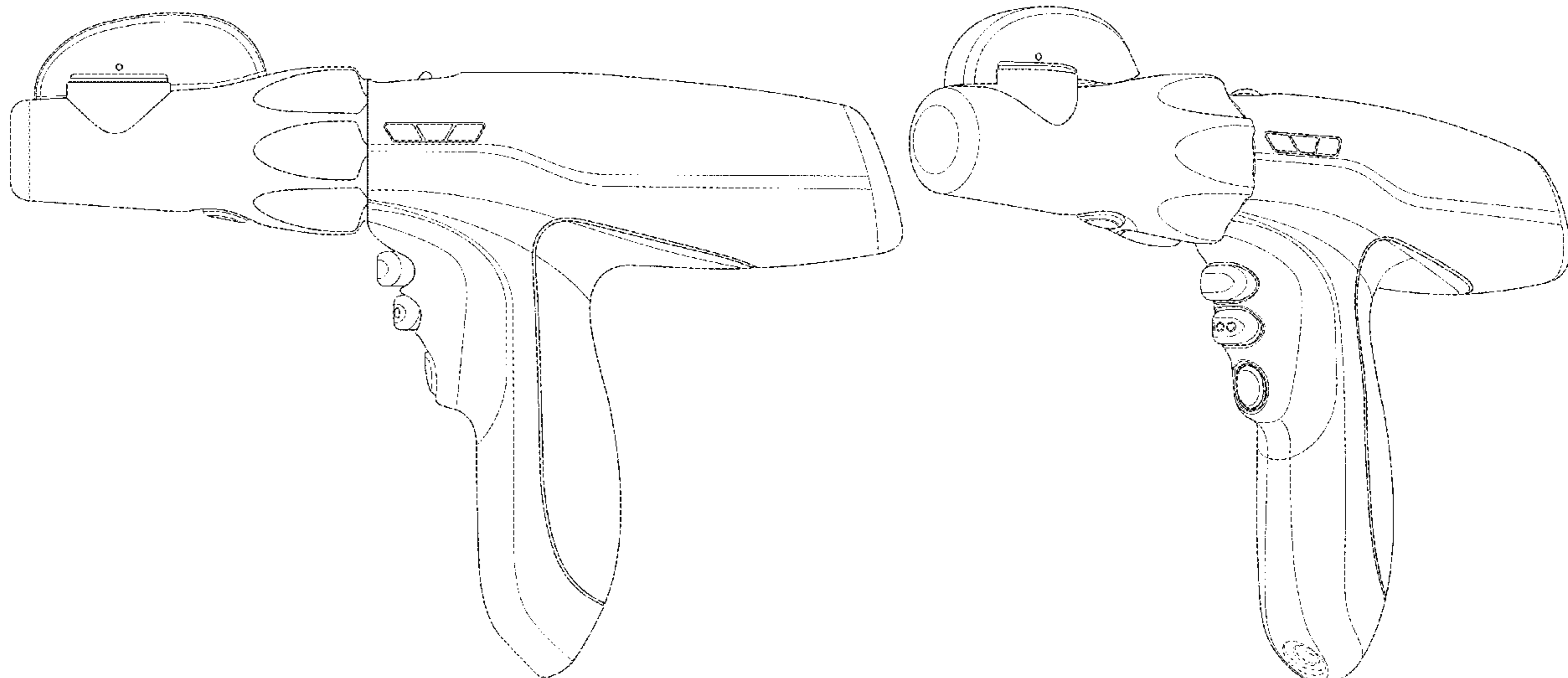

(56)

References Cited

U.S. PATENT DOCUMENTS

D353,526 S *	12/1994	Hoshino	D8/68	D679,011 S *	3/2013	Kitayama	D24/133
D353,888 S *	12/1994	Raines	D24/146	D687,549 S *	8/2013	Johnson	D24/133
D354,564 S *	1/1995	Medema	D24/145	D693,466 S *	11/2013	Dallemagne	D24/144
D384,261 S *	9/1997	Hayakawa	D8/68	D700,323 S *	2/2014	Affonce	D24/144
D403,936 S *	1/1999	Somers	D8/68	D700,699 S *	3/2014	O'Leary	D24/146
D408,249 S *	4/1999	Fallandy	D8/68	D700,967 S *	3/2014	O'Leary	D24/146
D436,510 S *	1/2001	Bazayev	D8/68	D708,742 S *	7/2014	Dallemagne	D24/133
D437,539 S *	2/2001	Kilmer	D8/68	D709,194 S *	7/2014	Miller	D24/143
D443,491 S *	6/2001	Robson	B25F 5/02 D8/61	D716,945 S *	11/2014	Miller	D24/148
D454,951 S *	3/2002	Bon	D24/108	D718,594 S *	12/2014	Waldron	D8/68
D459,182 S *	6/2002	Morgan	D8/68	8,931,679 B2 *	1/2015	Kostrzewski	A61B 17/2909 227/175.1
D459,644 S *	7/2002	Morgan	D8/68	D731,648 S *	6/2015	Rencher	D24/144
D460,675 S *	7/2002	Morgan	D8/68	D740,414 S *	10/2015	Katsura	D24/133
D466,209 S *	11/2002	Bon	D24/108	D743,547 S *	11/2015	Chang	D24/146
D476,209 S *	6/2003	Chen	D8/68	D744,099 S *	11/2015	Osada	D24/145
D478,986 S *	8/2003	Johnston	D24/133	D744,100 S *	11/2015	Chang	D24/146
D482,947 S *	12/2003	Lin	D8/68	D745,146 S *	12/2015	Hess	D24/133
D485,148 S *	1/2004	Chen	D8/68	D748,259 S *	1/2016	Okihisa	D24/144
D486,370 S *	2/2004	Chen	D8/68	D748,260 S *	1/2016	Chang	D24/146
D486,713 S *	2/2004	Lai	D8/68	D750,245 S *	2/2016	Chang	D24/148
D488,040 S *	4/2004	Chen	D8/68	D765,243 S *	8/2016	Halbert	D24/133
D488,041 S *	4/2004	Chen	D8/68	D770,616 S *	11/2016	Halbert	D24/133
D488,694 S *	4/2004	Chen	D8/68	D776,221 S *	1/2017	Malcolm	D22/104
D496,997 S *	10/2004	Dycus	D24/144	D784,537 S *	4/2017	Houssiere	D24/146
D509,589 S *	9/2005	Wells	D24/133	D785,173 S *	4/2017	Oberkircher	D24/138
D514,413 S *	2/2006	Cuenca	D8/68	D790,940 S *	7/2017	Dill	D8/68
D526,872 S *	8/2006	Snider	D8/61	D799,038 S *	10/2017	Chang	D24/146
D531,000 S *	10/2006	Meyers	D8/68	D800,306 S *	10/2017	Hess	D24/145
D531,311 S *	10/2006	Guerra	D24/146	D800,904 S *	10/2017	Leimbach	D24/145
D531,873 S *	11/2006	Liu	D8/68	D830,807 S *	10/2018	Waldron	D8/68
D535,027 S *	1/2007	James	D24/144	D831,212 S *	10/2018	Clifford	D24/146
D543,811 S *	6/2007	Lueschen	D8/44	D831,819 S *	10/2018	Genender	D24/108
D547,626 S *	7/2007	Lueschen	D8/44	D840,032 S *	2/2019	Clifford	D24/146
D547,631 S *	7/2007	Schmid	D8/68	D841,788 S *	2/2019	Gough	D23/314
D549,061 S *	8/2007	Schmid	D8/68	D847,990 S *	5/2019	Kimball	D24/145
D568,992 S *	5/2008	Bacher	D24/133	D860,441 S *	9/2019	Spycher	D24/133
D575,401 S *	8/2008	Hixson	D24/144	D861,166 S *	9/2019	Hess	D24/145
D576,854 S *	9/2008	Aglassinger	D8/68	D865,964 S *	11/2019	Miller	D24/144
D580,548 S *	11/2008	Mouret	D24/133	D869,927 S *	12/2019	Waldron	D8/68
D580,726 S *	11/2008	Murray	D8/68	D874,643 S *	2/2020	Genender	D24/108
D582,236 S *	12/2008	Chen	D8/68	D882,783 S *	4/2020	Shelton, IV	D24/145
D582,237 S *	12/2008	Chen	D8/68	D895,112 S *	9/2020	Miller	D24/144
D582,740 S *	12/2008	Weinberg	D8/68	D896,364 S *	9/2020	Genender	D24/108
D582,742 S *	12/2008	Aglassinger	D8/68	10,926,391 B2 *	2/2021	Jablonski	B25C 7/00
D586,637 S *	2/2009	Tirone	D8/68	D919,088 S *	5/2021	Fumex	D24/146
D593,386 S *	6/2009	Liao	D8/68	D920,510 S *	5/2021	Funakoshi	D24/138
D605,488 S *	12/2009	Aglassinger	D8/68	D926,979 S *	8/2021	Funakoshi	A61B 17/2909 D24/138
D606,192 S *	12/2009	Summerer	D24/133	D933,820 S *	10/2021	Ota	D24/133
D609,809 S *	2/2010	Summerer	D24/138	D935,017 S *	11/2021	Kawanishi	D24/138
D619,438 S *	7/2010	Lee	D8/68	D936,221 S *	11/2021	Jensen	D24/138
D621,503 S *	8/2010	Otten	D24/133	D937,416 S *	11/2021	Funakoshi	D24/138
D627,066 S *	11/2010	Romero	D24/133	D938,027 S *	12/2021	Zhang	D24/133
D631,965 S *	2/2011	Price	D24/145	D946,146 S *	3/2022	Gee	D24/133
D640,789 S *	6/2011	Peine	D24/133	D947,378 S *	3/2022	Adams	D24/146
D650,074 S *	12/2011	Hunt	D24/133	D948,046 S *	4/2022	Choi	D24/147
D668,337 S *	10/2012	Schurg	D24/144	D950,725 S *	5/2022	Kang	D24/138
D679,010 S *	3/2013	Kitayama	D24/133	D952,844 S *	5/2022	Holzer	D24/133
				D953,529 S *	5/2022	Holzer	D24/133

* cited by examiner

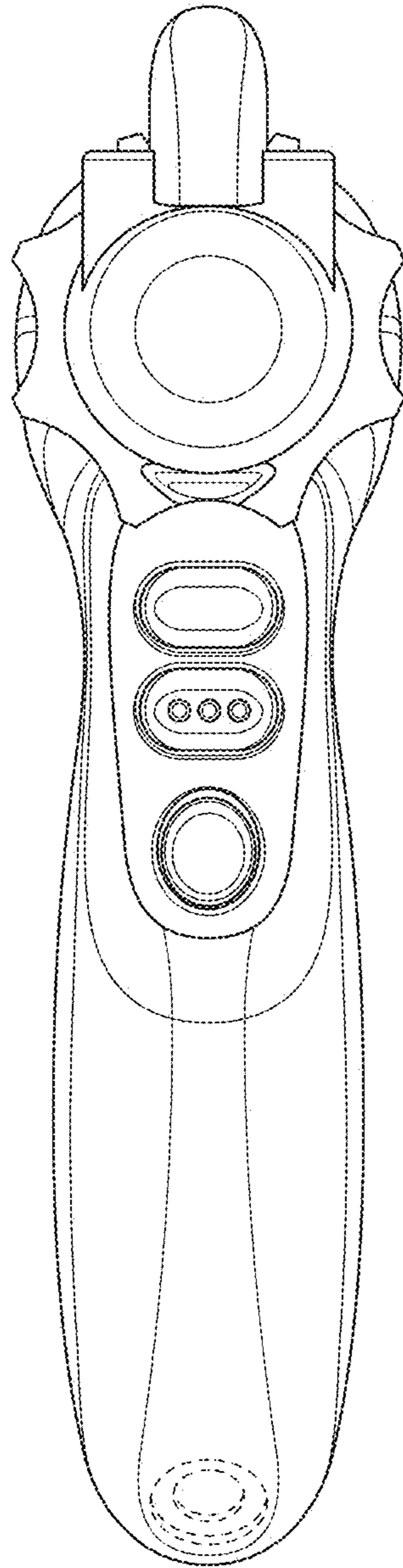

FIG. 1

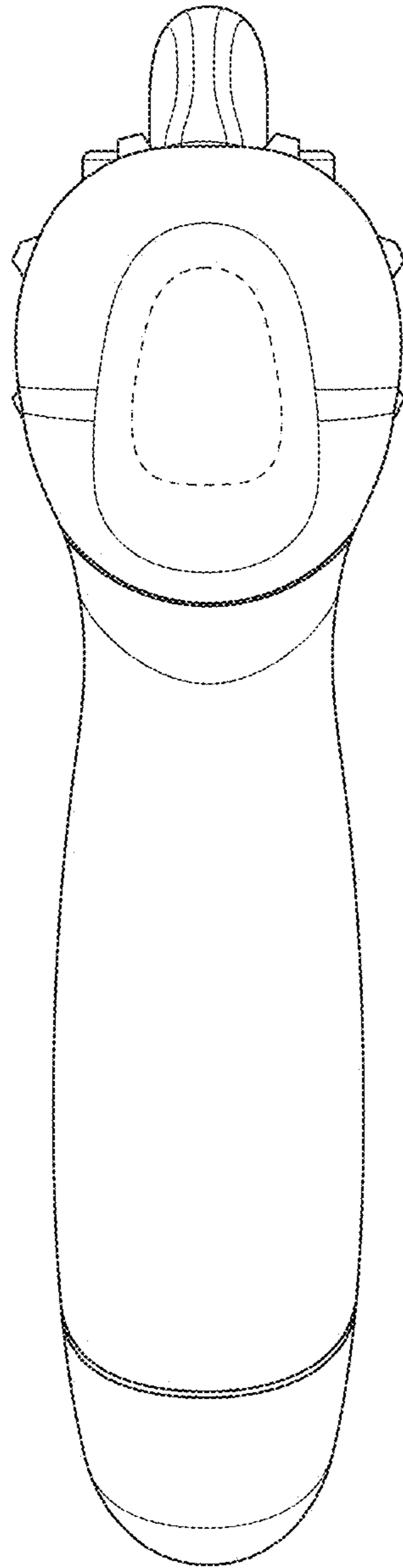

FIG. 2

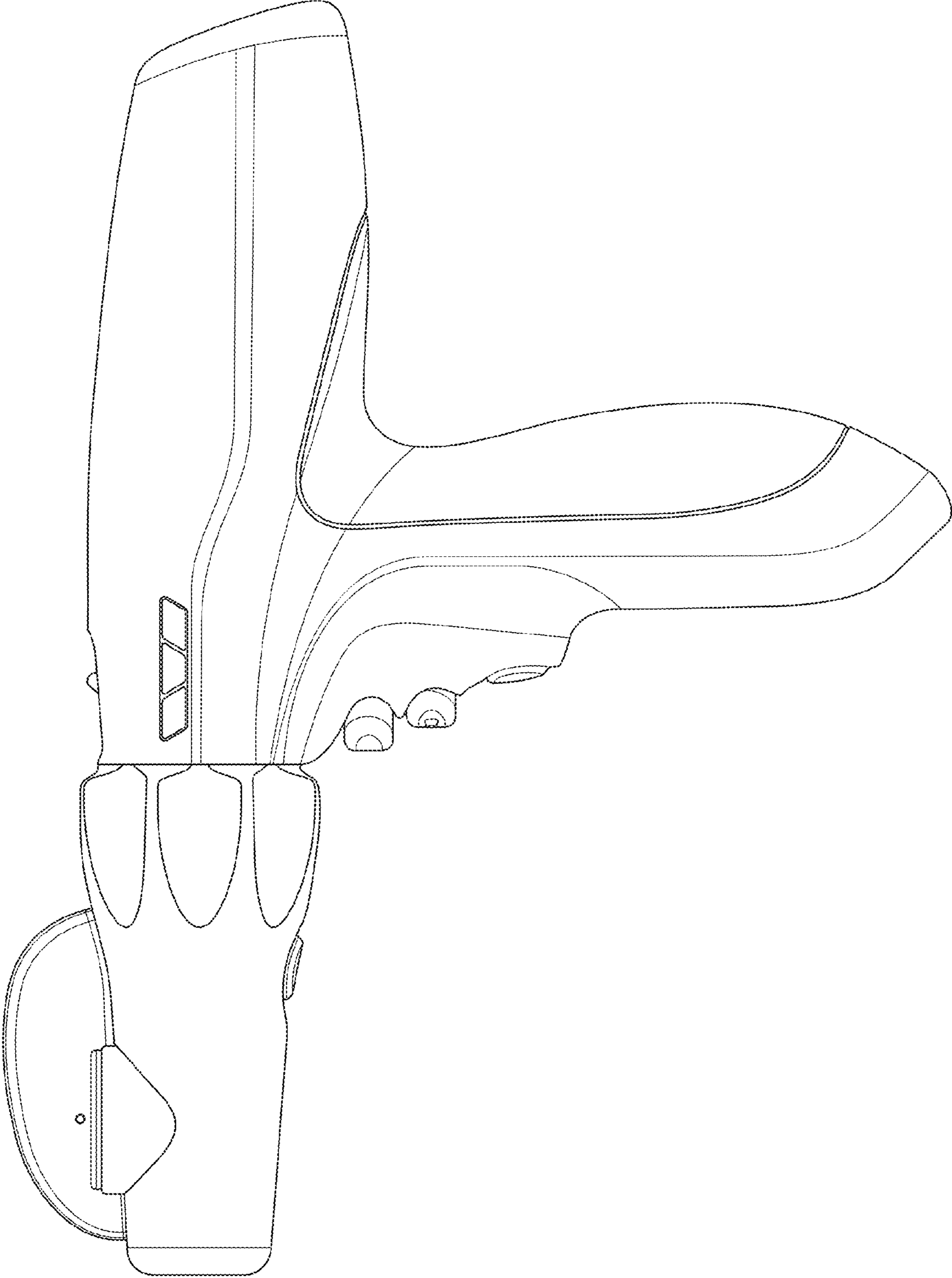

FIG. 3

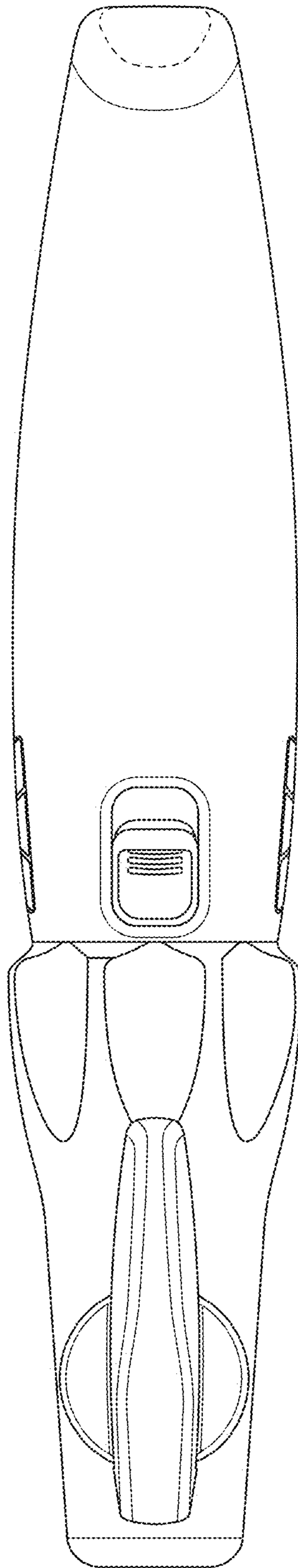

FIG. 4

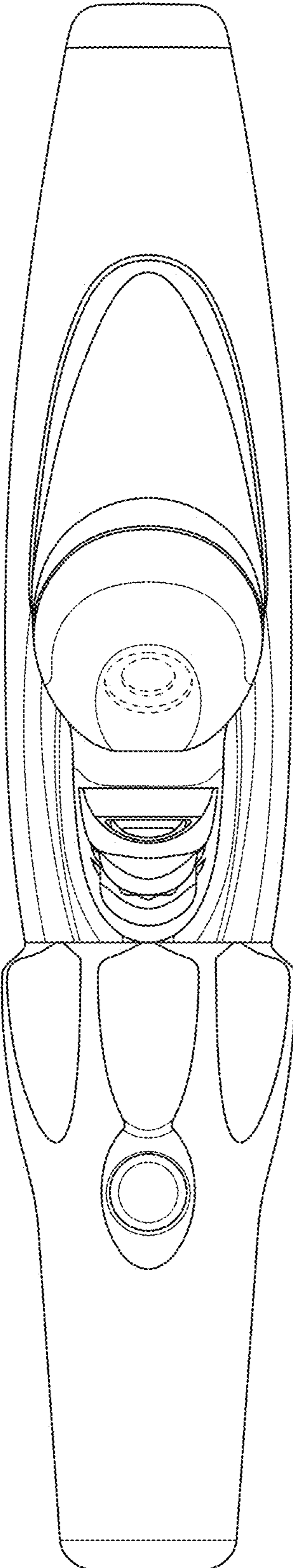

FIG. 5

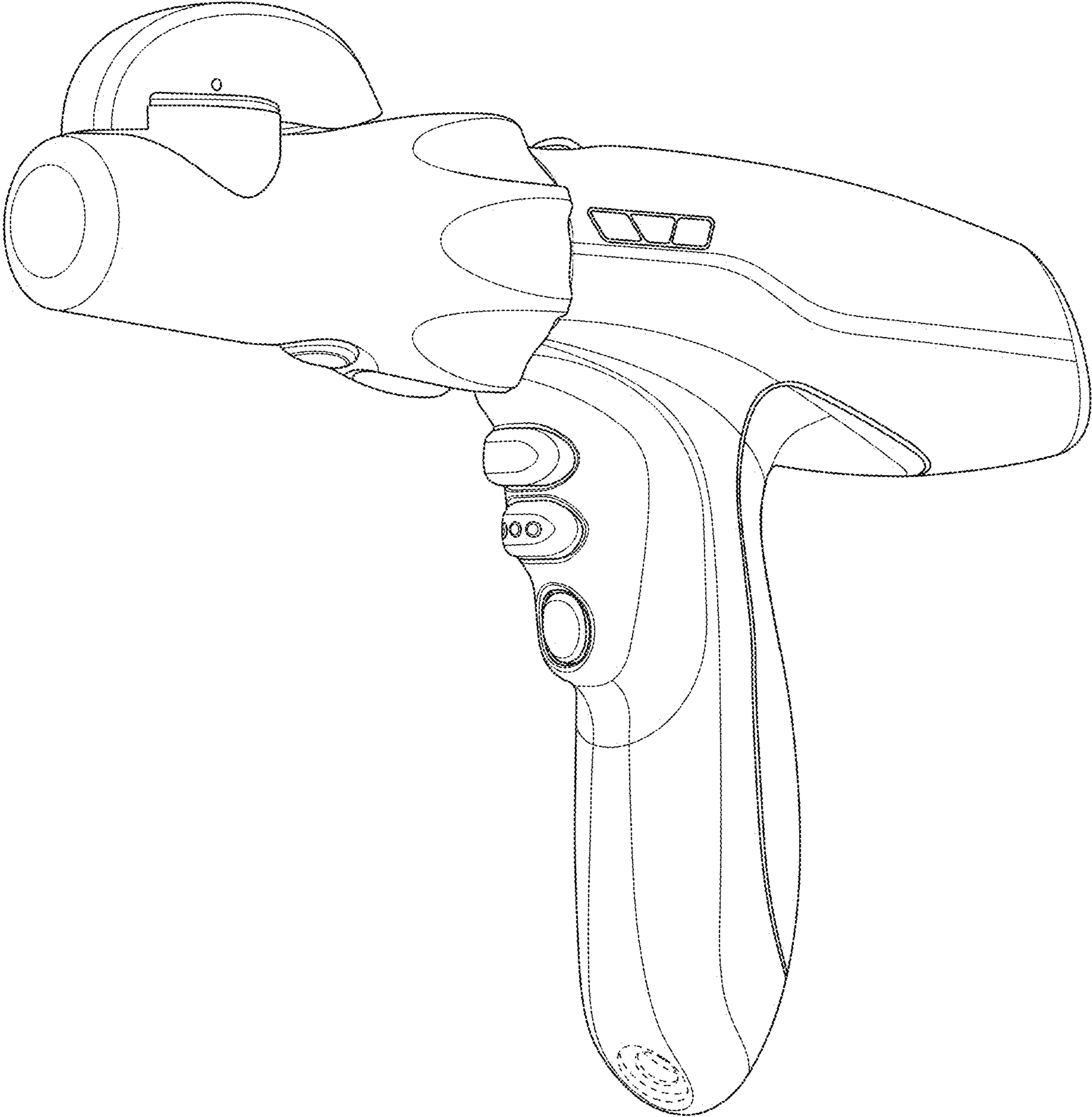

FIG. 6