

US00D969282S

(12) **United States Design Patent** (10) **Patent No.:** **US D969,282 S**
Longo (45) **Date of Patent:** **** *Nov. 8, 2022**

- (54) **WATER HEATER POSITIONING AID**
- (71) Applicant: **Giulienne Longo**, Granada Hills, CA (US)
- (72) Inventor: **Giulienne Longo**, Granada Hills, CA (US)
- (73) Assignee: **Giulienne Longo**, Granada Hills, CA (US)
- (*) Notice: This patent is subject to a terminal disclaimer.
- (**) Term: **15 Years**
- (21) Appl. No.: **29/600,328**
- (22) Filed: **Apr. 11, 2017**
- (51) **LOC (13) Cl.** **23-03**
- (52) **U.S. Cl.**
USPC **D23/322**
- (58) **Field of Classification Search**
USPC D23/314, 318, 320, 321, 322, 323, 328, D23/341; D8/349, 353, 354
CPC B62B 1/264; F24H 9/06; F24H 9/2007
See application file for complete search history.

- 8,342,139 B2 * 1/2013 Rockwell F24D 19/088 122/19.2
- D677,369 S * 3/2013 Tindall D23/322
- 8,517,204 B1 8/2013 Spaninger
- D768,843 S * 10/2016 Honeyball D23/386
- D817,151 S * 5/2018 Jensen D8/354
- D829,084 S * 9/2018 Velardi D8/380
- D880,282 S * 4/2020 Wheeler D8/356
- D921,474 S * 6/2021 Borst D8/349
- 2012/0067301 A1 * 3/2012 Braathen F24H 9/2021 122/19.1
- 2016/0009475 A1 * 1/2016 Powers F24H 9/1809 122/19.2
- 2016/0221715 A1 * 8/2016 Pratt F16L 1/0246
- 2018/0055226 A1 * 3/2018 Prince F24H 9/06

(Continued)

Primary Examiner — Ania Aman
(74) *Attorney, Agent, or Firm* — Ferguson Case Orr Paterson

(57) **CLAIM**

The ornamental design for a water heater positioning aid, as shown and described.

DESCRIPTION

FIG. 1 is a top perspective view of the water heater positioning aid.

FIG. 2 is a bottom perspective view of the water heater positioning aid of FIG. 1.

FIG. 3 is a top view of the water heater positioning aid of FIG. 1.

FIG. 4 is a bottom view of the water heater positioning aid of FIG. 1.

FIG. 5 is a right end view of the water heater positioning aid of FIG. 1, the left end view being a mirror image thereof.

FIG. 6 is a front view of the water heater positioning aid of FIG. 1; and,

FIG. 7 is a rear view of the water heater positioning aid of FIG. 1.

1 Claim, 3 Drawing Sheets

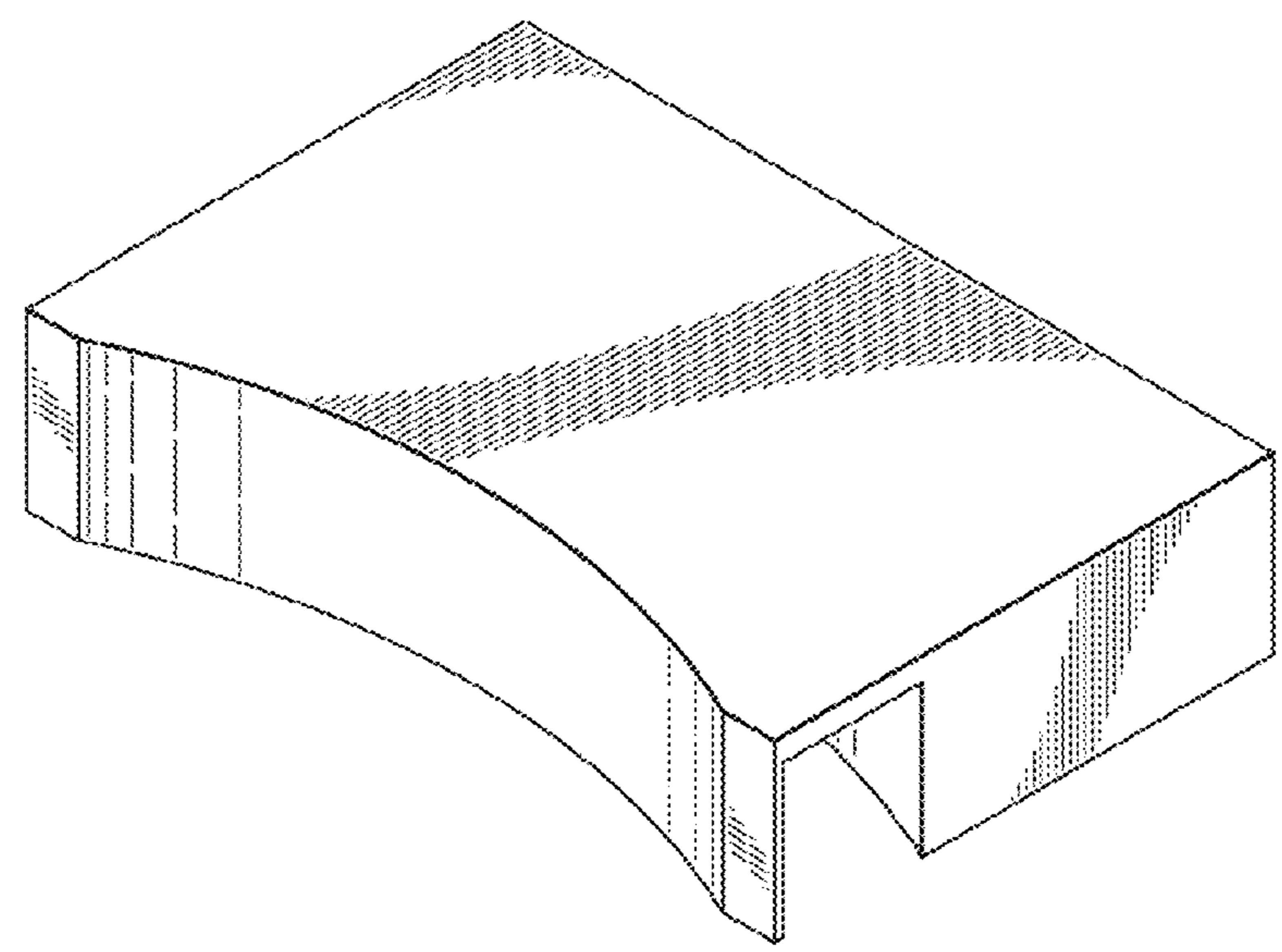

(56)

References Cited

U.S. PATENT DOCUMENTS

2019/0145661 A1* 5/2019 Gardner F24H 9/165
122/14.3
2020/0318859 A1* 10/2020 Wofford F24H 9/16
2021/0131703 A1* 5/2021 Humber F24D 19/088

* cited by examiner

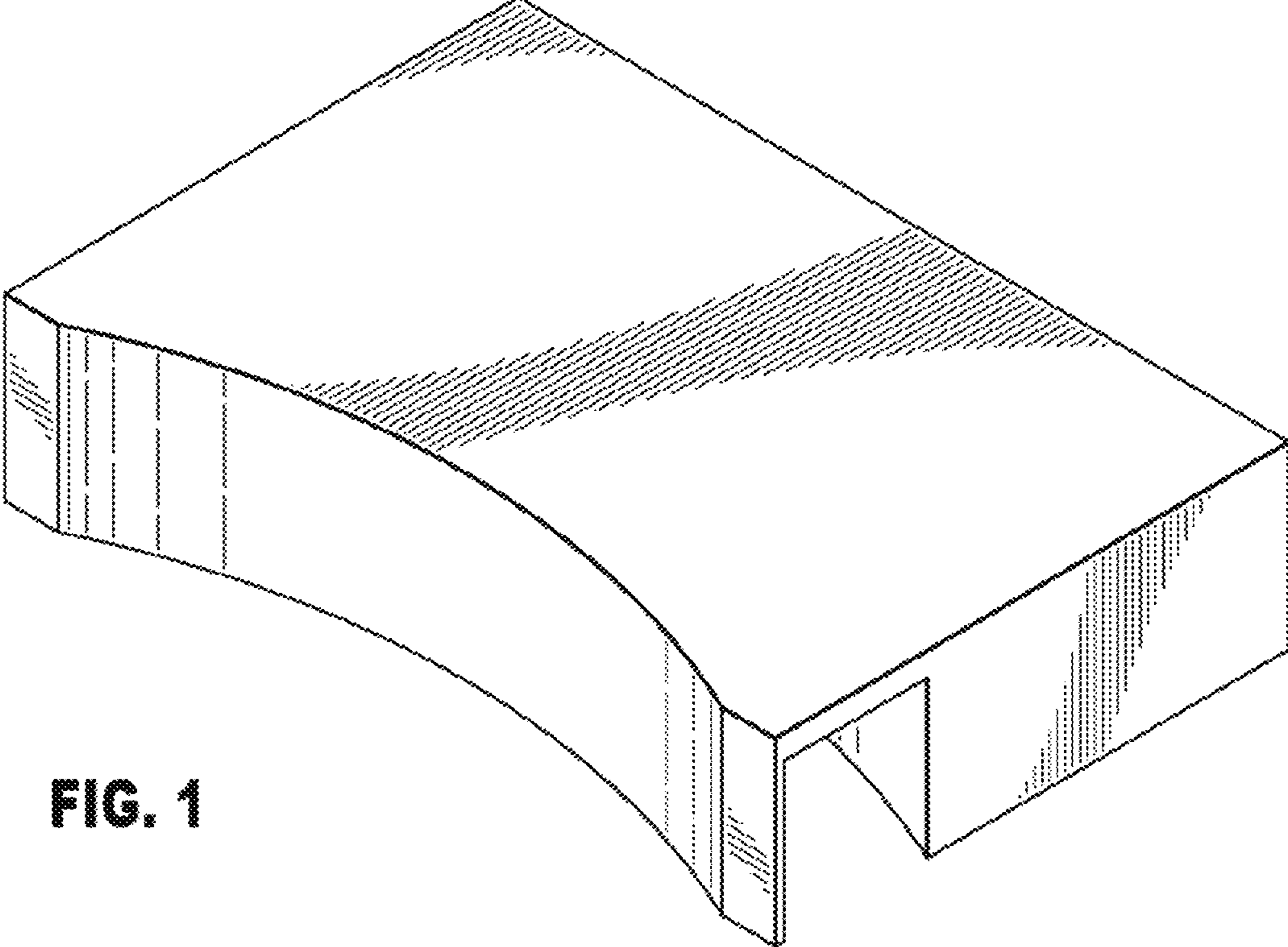

FIG. 1

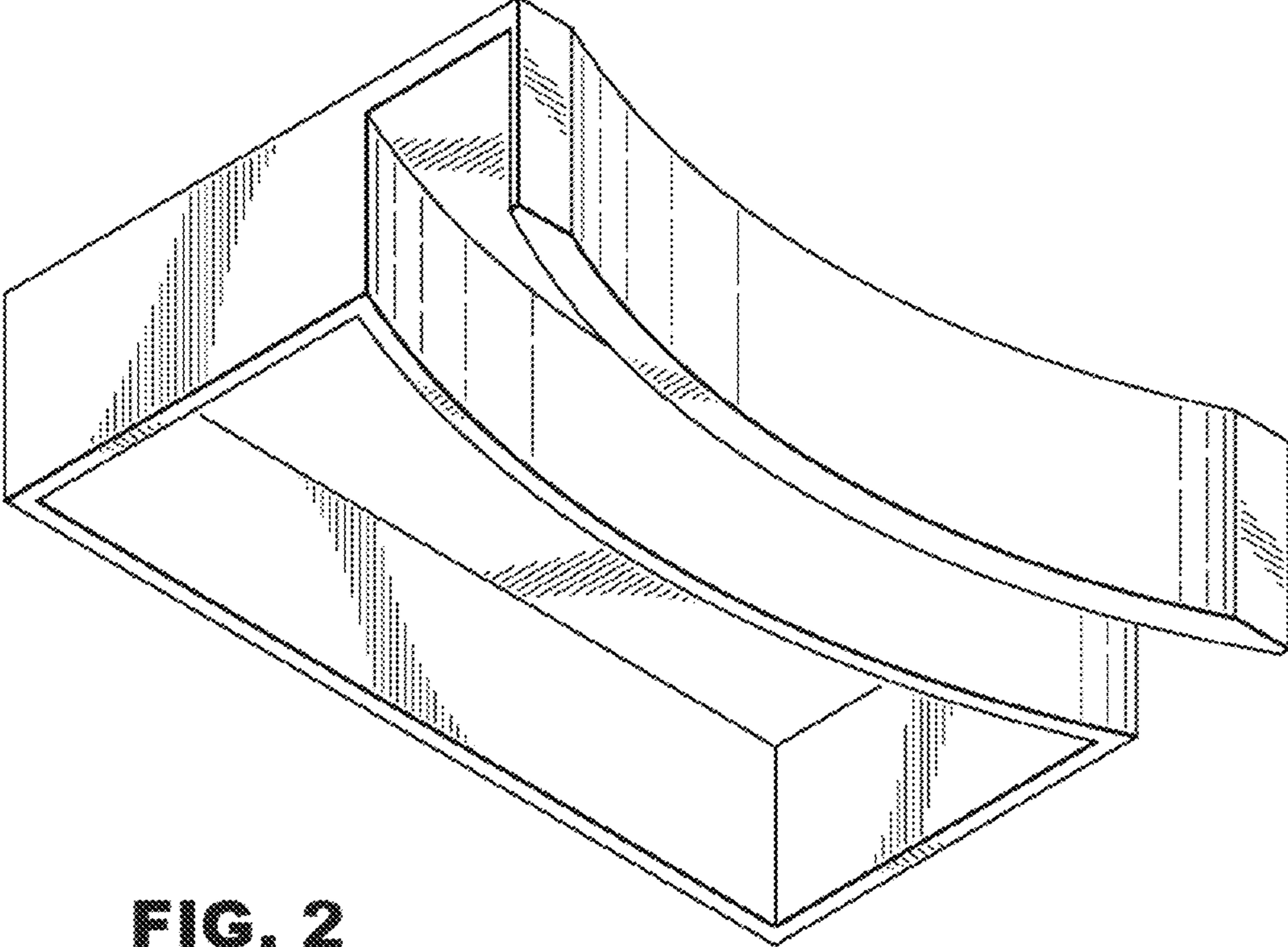

FIG. 2

FIG. 3

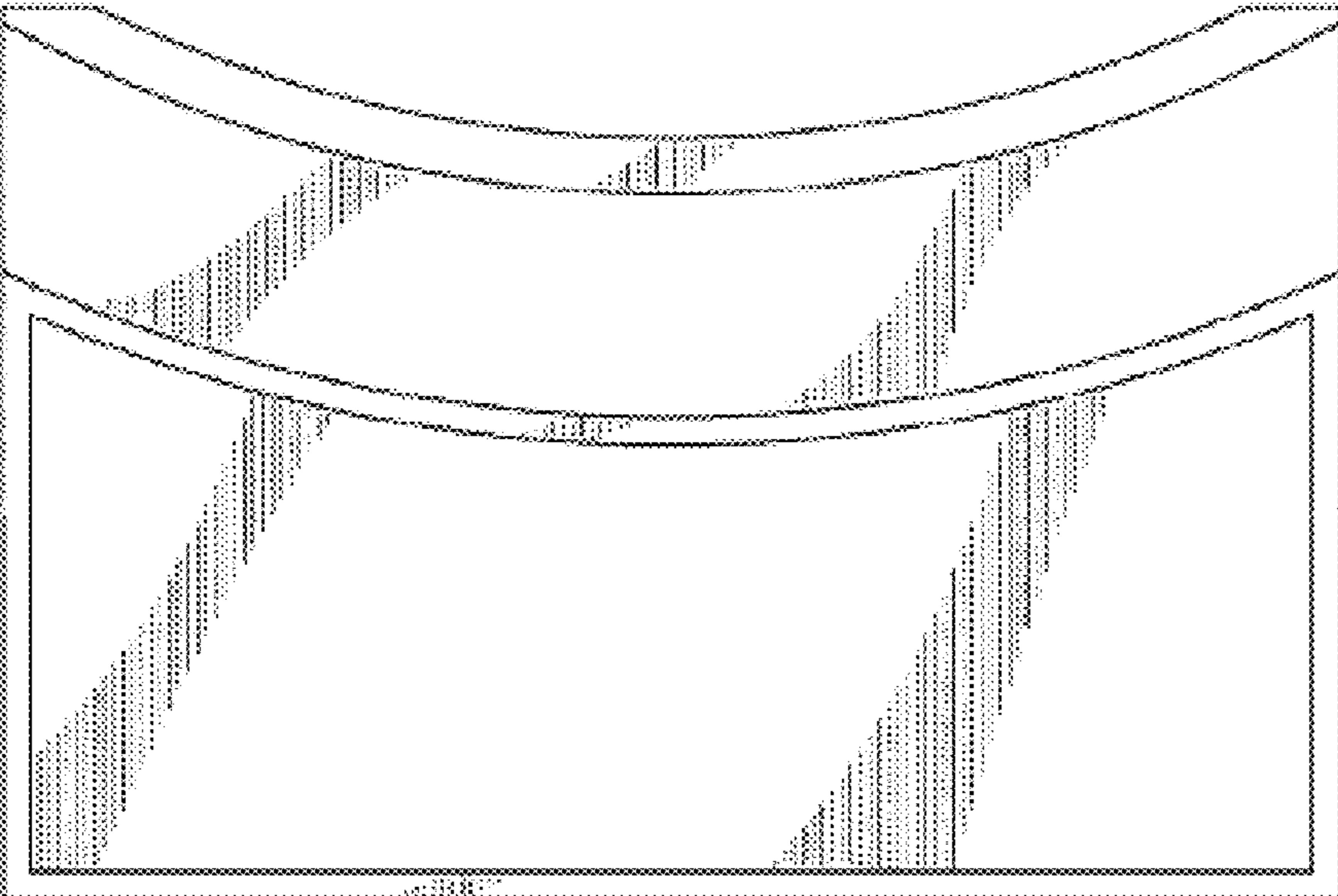
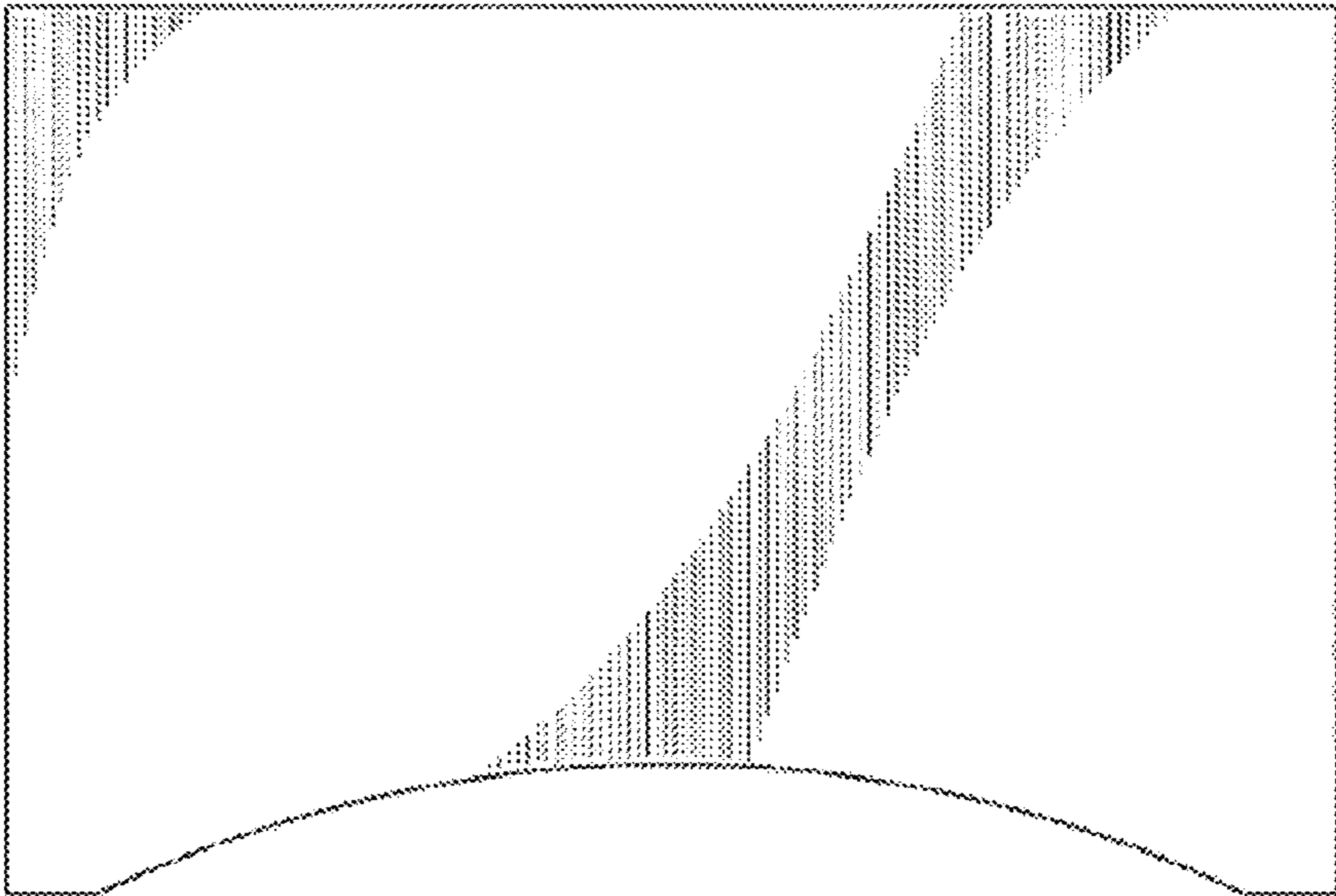

FIG. 4

FIG. 5

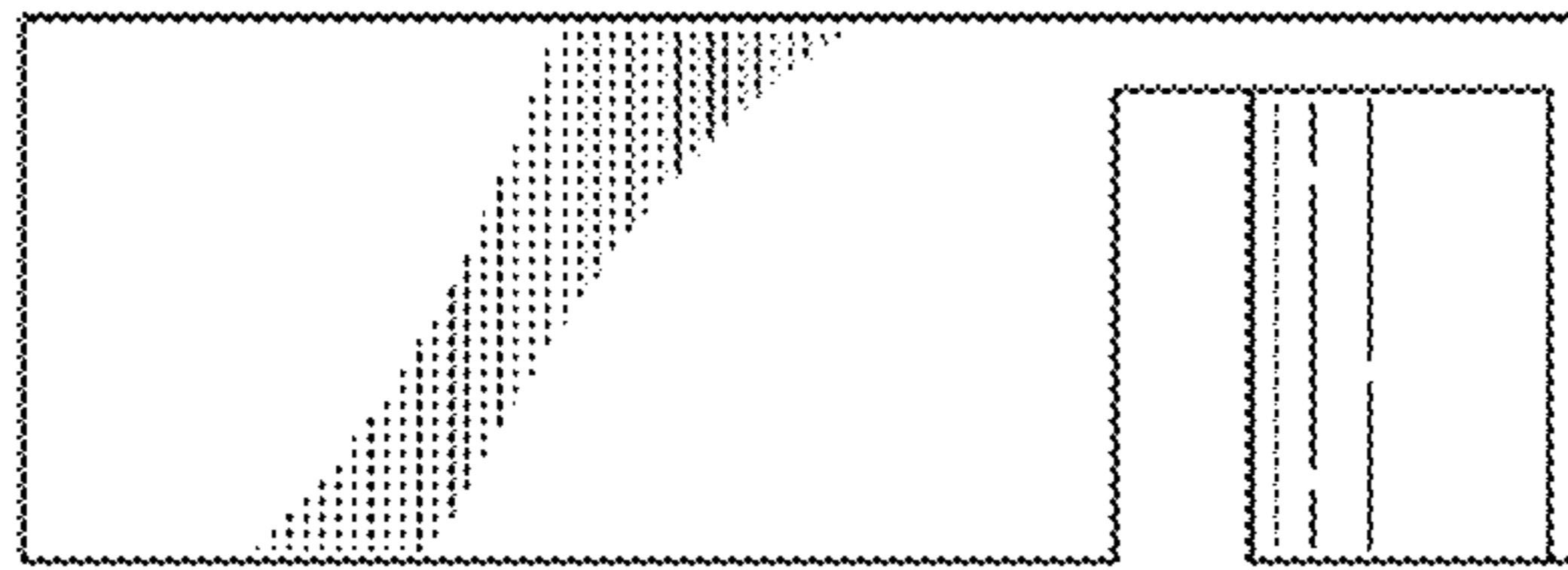

FIG. 6

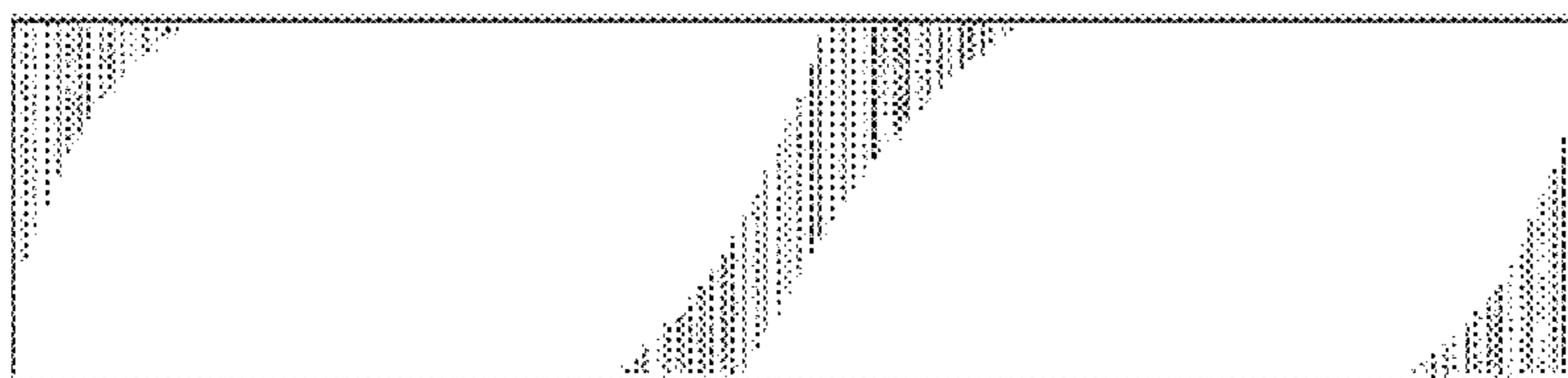

FIG. 7