

US00D969233S

(12) **United States Design Patent** (10) **Patent No.:** **US D969,233 S**  
**Li** (45) **Date of Patent:** **\*\* Nov. 8, 2022**

(54) **BUILDING BLOCK SET**

(71) Applicant: **Zhitao Li**, Jiaxing (CN)

(72) Inventor: **Zhitao Li**, Jiaxing (CN)

(\*\*) Term: **15 Years**

(21) Appl. No.: **29/762,761**

(22) Filed: **Dec. 18, 2020**

(51) **LOC (13) Cl.** ..... **21-01**

(52) **U.S. Cl.**  
USPC ..... **D21/494**; D21/491

(58) **Field of Classification Search**  
USPC ..... D21/484–505  
CPC .... A63H 33/04; A63H 33/044; A63H 33/046;  
A63H 33/06; A63H 33/062; A63H 33/08;  
A63H 33/086; A63H 33/088; A63H  
33/10; A63H 33/101; A63H 33/108;  
A63H 33/12; A63H 33/14; A63H 33/26  
See application file for complete search history.

(56) **References Cited**

**U.S. PATENT DOCUMENTS**

D291,217 S *	8/1987	Tapdrup .....	D21/490
D308,233 S *	5/1990	Fish, Jr. ....	D21/490
D308,234 S *	5/1990	Fish, Jr. ....	D21/490
D314,407 S *	2/1991	Wentling .....	D21/490
D342,555 S *	12/1993	Berggreen .....	D21/501
D350,787 S *	9/1994	Hojlund .....	D21/501
D351,005 S *	9/1994	Hojlund .....	D21/501
D353,866 S *	12/1994	Houry .....	D21/814
D353,867 S *	12/1994	Houry .....	D21/814
D354,108 S *	1/1995	Houry .....	D21/814
D360,658 S *	7/1995	Voldmester .....	D21/501
D360,908 S *	8/1995	Ruskai .....	D21/501
D362,474 S *	9/1995	Voldmester .....	D21/501
D373,154 S *	8/1996	Riis .....	D21/489
D381,730 S *	7/1997	van Huystee .....	D21/814
D384,989 S *	10/1997	Andersen .....	D21/491
D384,992 S *	10/1997	Nielsen .....	D21/491
D387,097 S *	12/1997	Nielsen .....	D21/494
D412,944 S *	8/1999	Jensen .....	D21/494
D422,035 S *	3/2000	Cyrus .....	D21/501
D478,360 S *	8/2003	Manville .....	D21/494

D492,741 S *	7/2004	Hradisky .....	D21/524
D503,438 S *	3/2005	Manville .....	D21/494
D537,484 S *	2/2007	Ganderton .....	D21/494
D614,707 S *	4/2010	Ryaa .....	D21/501
D616,504 S *	5/2010	Andersen .....	D21/492
D618,737 S *	6/2010	Andersen .....	D21/501
D632,346 S *	2/2011	Hardstaff .....	D21/501
D784,459 S *	4/2017	Wallace .....	D21/491
9,821,246 B2 *	11/2017	Rieber .....	A63G 31/00

\* cited by examiner

*Primary Examiner* — Cynthia M. Chin

(57) **CLAIM**

The ornamental design for a building block set, as shown and described.

**DESCRIPTION**

FIG. 1 is a front elevational view of a first component of a building block set, shown separately for ease of illustration; FIG. 2 is a rear elevational view thereof; FIG. 3 is a left side elevational view thereof; FIG. 4 is a right side elevational view thereof; FIG. 5 is a top plan view thereof; FIG. 6 is a bottom plan view thereof; FIG. 7 is a perspective view thereof; FIG. 8 is a front elevational view of a second component of the building block set, shown separately for ease of illustration; FIG. 9 is a rear elevational view thereof; FIG. 10 is a left side elevational view thereof; FIG. 11 is a right side elevational view thereof; FIG. 12 is a top plan view thereof; FIG. 13 is a bottom plan view thereof; FIG. 14 is a perspective view thereof; FIG. 15 is a front elevational view of a third component of the building block set, shown separately for ease of illustration; FIG. 16 is a rear elevational view thereof; FIG. 17 is a left side elevational view thereof; FIG. 18 is a right side elevational view thereof; FIG. 19 is a top plan view thereof; FIG. 20 is a bottom plan view thereof; FIG. 21 is a perspective view thereof;

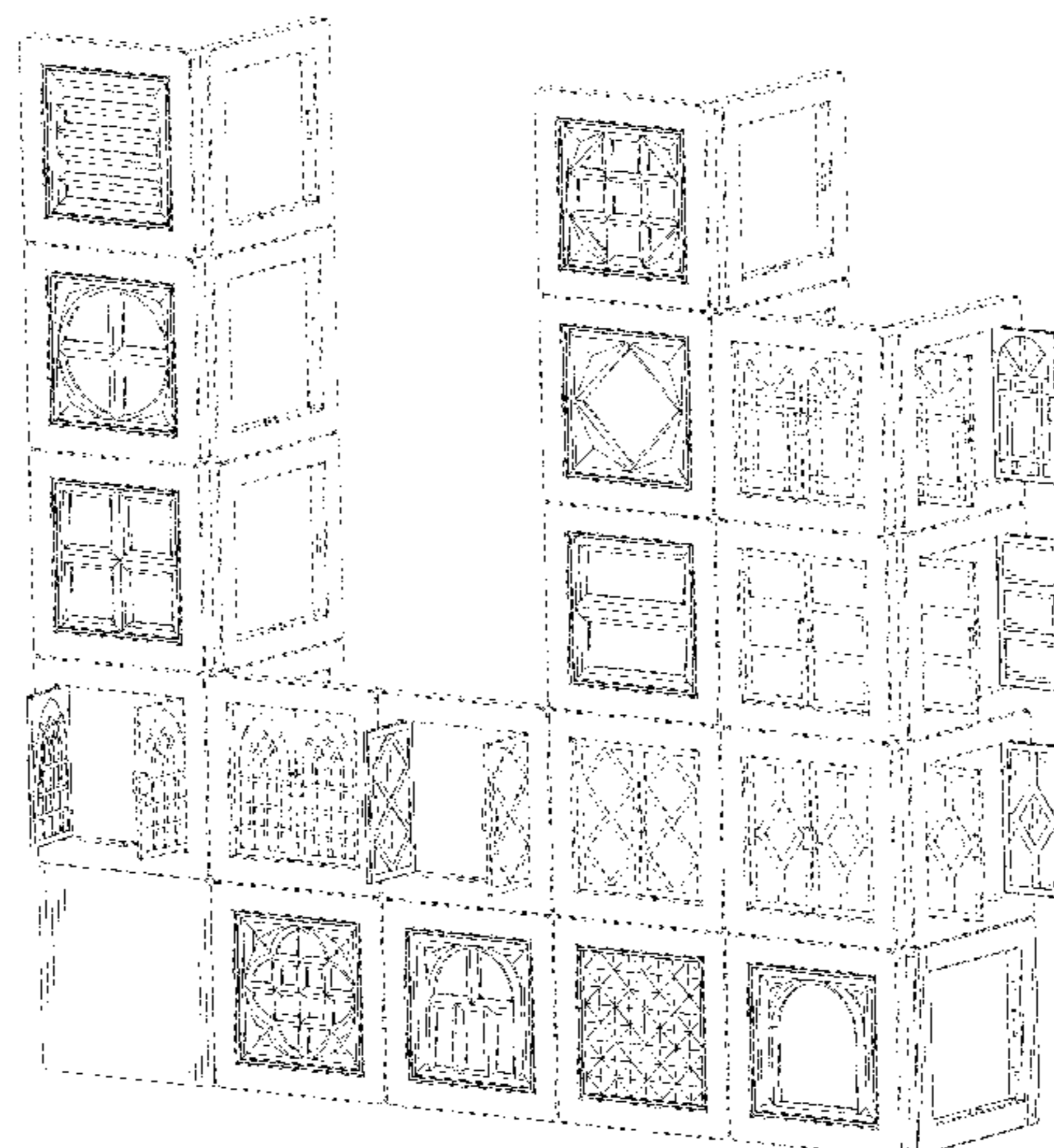

FIG. 22 is a front elevational view of a fourth component of the building block set, shown separately for ease of illustration;

FIG. 23 is a rear elevational view thereof;

FIG. 24 is a left side elevational view thereof;

FIG. 25 is a right side elevational view thereof;

FIG. 26 is a top plan view thereof;

FIG. 27 is a bottom plan view thereof;

FIG. 28 is a perspective view thereof;

FIG. 29 is a front elevational view of a fifth component of the building block set, shown separately for ease of illustration;

FIG. 30 is a rear elevational view thereof;

FIG. 31 is a left side elevational view thereof;

FIG. 32 is a right side elevational view thereof;

FIG. 33 is a top plan view thereof;

FIG. 34 is a bottom plan view thereof;

FIG. 35 is a perspective view thereof;

FIG. 36 is a front elevational view of a sixth component of the building block set, shown separately for ease of illustration;

FIG. 37 is a rear elevational view thereof;

FIG. 38 is a left side elevational view thereof;

FIG. 39 is a right side elevational view thereof;

FIG. 40 is a top plan view thereof;

FIG. 41 is a bottom plan view thereof;

FIG. 42 is a perspective view thereof;

FIG. 43 is a front elevational view of a seventh component of the building block set, shown separately for ease of illustration;

FIG. 44 is a rear elevational view thereof;

FIG. 45 is a left side elevational view thereof;

FIG. 46 is a right side elevational view thereof;

FIG. 47 is a top plan view thereof;

FIG. 48 is a bottom plan view thereof;

FIG. 49 is a perspective view thereof;

FIG. 50 is a front elevational view of an eighth component of the building block set, shown separately for ease of illustration;

FIG. 51 is a rear elevational view thereof;

FIG. 52 is a left side elevational view thereof;

FIG. 53 is a right side elevational view thereof;

FIG. 54 is a top plan view thereof;

FIG. 55 is a bottom plan view thereof;

FIG. 56 is a perspective view thereof;

FIG. 57 is a front elevational view of a ninth component of the building block set, shown separately for ease of illustration;

FIG. 58 is a rear elevational view thereof;

FIG. 59 is a left side elevational view thereof;

FIG. 60 is a right side elevational view thereof;

FIG. 61 is a top plan view thereof;

FIG. 62 is a bottom plan view thereof;

FIG. 63 is a perspective view thereof;

FIG. 64 is a front elevational view of a tenth component of the building block set, shown separately for ease of illustration;

FIG. 65 is a rear elevational view thereof;

FIG. 66 is a left side elevational view thereof;

FIG. 67 is a right side elevational view thereof;

FIG. 68 is a top plan view thereof;

FIG. 69 is a bottom plan view thereof;

FIG. 70 is a perspective view thereof;

FIG. 71 is a front elevational view of an eleventh component of the building block set, shown separately for ease of illustration;

FIG. 72 is a rear elevational view thereof;

FIG. 73 is a left side elevational view thereof;

FIG. 74 is a right side elevational view thereof;

FIG. 75 is a top plan view thereof;

FIG. 76 is a bottom plan view thereof;

FIG. 77 is a perspective view thereof;

FIG. 78 is a front elevational view of a twelfth component of the building block set, shown separately for ease of illustration;

FIG. 79 is a rear elevational view thereof;

FIG. 80 is a left side elevational view thereof;

FIG. 81 is a right side elevational view thereof;

FIG. 82 is a top plan view thereof;

FIG. 83 is a bottom plan view thereof;

FIG. 84 is a perspective view thereof;

FIG. 85 is a front elevational view of a thirteenth component of the building block set, shown separately for ease of illustration;

FIG. 86 is a rear elevational view thereof;

FIG. 87 is a left side elevational view thereof;

FIG. 88 is a right side elevational view thereof;

FIG. 89 is a top plan view thereof;

FIG. 90 is a bottom plan view thereof;

FIG. 91 is a perspective view thereof;

FIG. 92 is a front elevational view of a fourteenth component of the building block set, shown separately for ease of illustration;

FIG. 93 is a rear elevational view thereof;

FIG. 94 is a left side elevational view thereof;

FIG. 95 is a right side elevational view thereof;

FIG. 96 is a top plan view thereof;

FIG. 97 is a bottom plan view thereof;

FIG. 98 is a perspective view thereof;

FIG. 99 is a front elevational view of a fifteenth component of the building block set, shown separately for ease of illustration;

FIG. 100 is a rear elevational view thereof;

FIG. 101 is a left side elevational view thereof;

FIG. 102 is a right side elevational view thereof;

FIG. 103 is a top plan view thereof;

FIG. 104 is a bottom plan view thereof;

FIG. 105 is a perspective view thereof;

FIG. 106 is a front elevational view of a sixteenth component of the building block set, shown separately for ease of illustration;

FIG. 107 is a rear elevational view thereof;

FIG. 108 is a left side elevational view thereof;

FIG. 109 is a right side elevational view thereof;

FIG. 110 is a top plan view thereof;

FIG. 111 is a bottom plan view thereof;

FIG. 112 is a perspective view thereof;

FIG. 113 is a front elevational view of a seventeenth component of the building block set, shown separately for ease of illustration;

FIG. 114 is a rear elevational view thereof;

FIG. 115 is a left side elevational view thereof;

FIG. 116 is a right side elevational view thereof;

FIG. 117 is a top plan view thereof;

FIG. 118 is a bottom plan view thereof;

FIG. 119 is a perspective view thereof; and,

FIG. 120 is an assembled perspective view of the building block set, showing all components.

The broken lines immediately adjacent to the shaded areas depict the bounds of the claimed design while all other broken lines are directed to environment. The broken lines form no part of the claimed design.

**1 Claim, 69 Drawing Sheets**

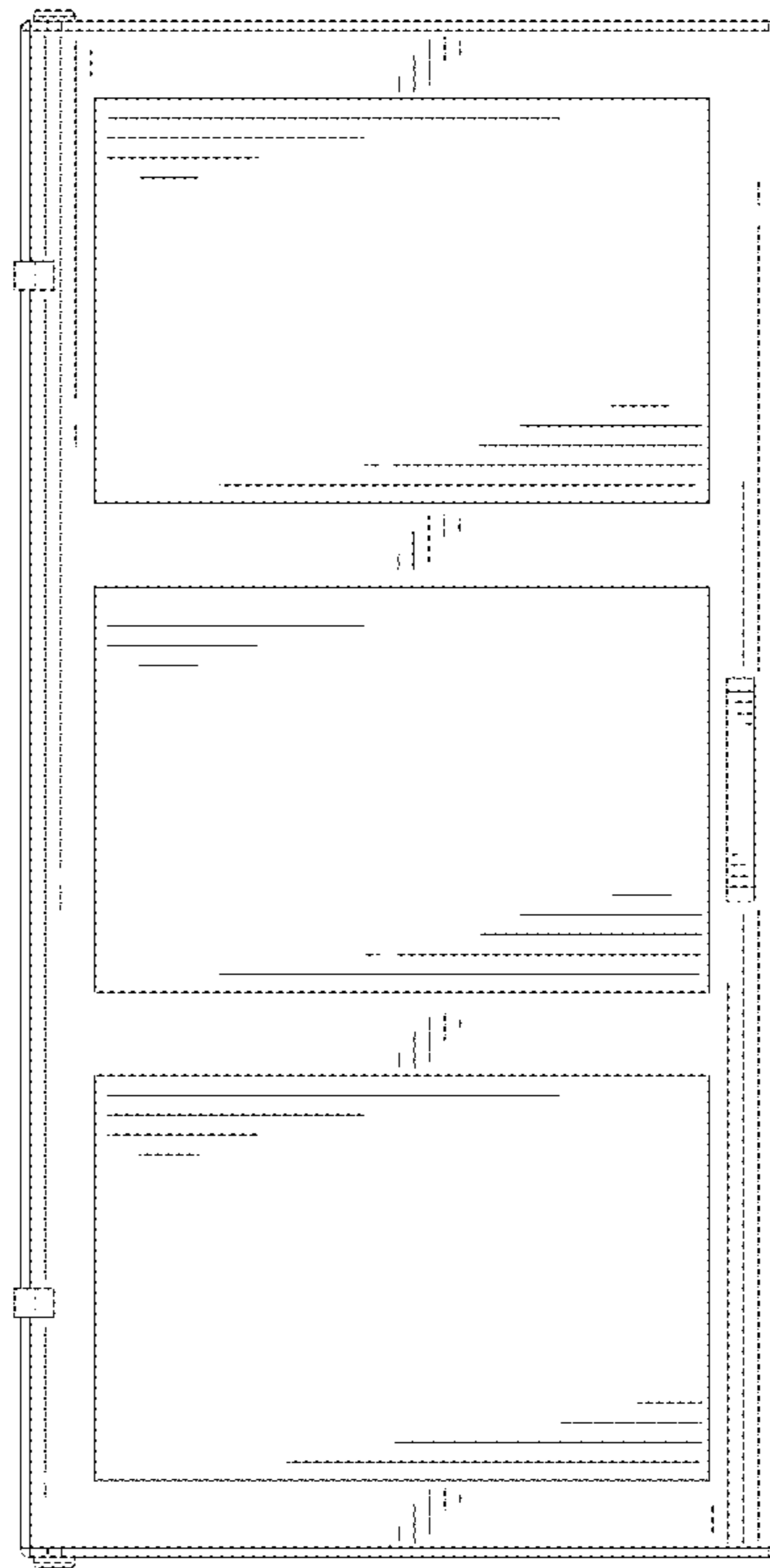

FIG. 1

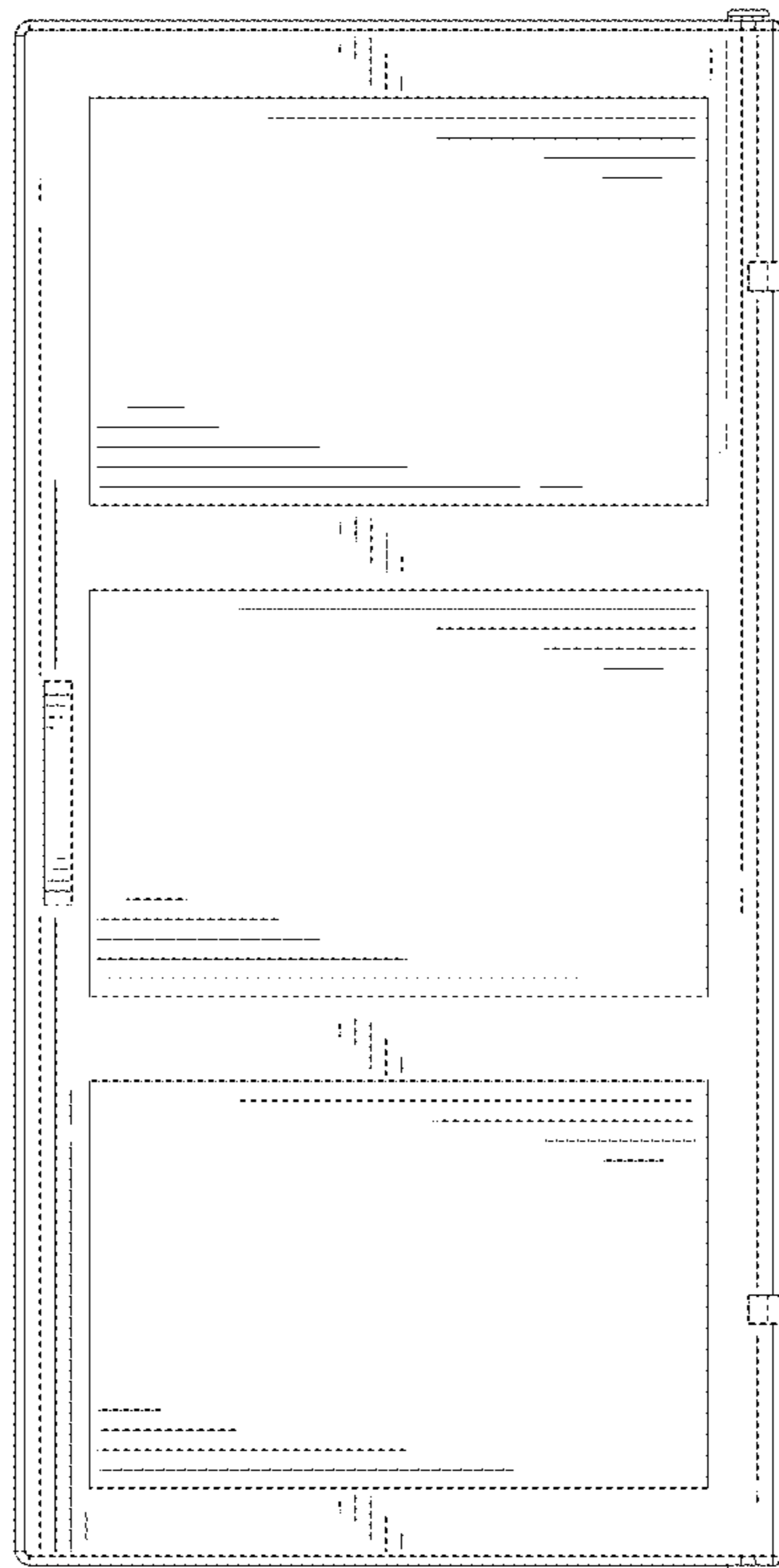

FIG. 2



FIG. 3

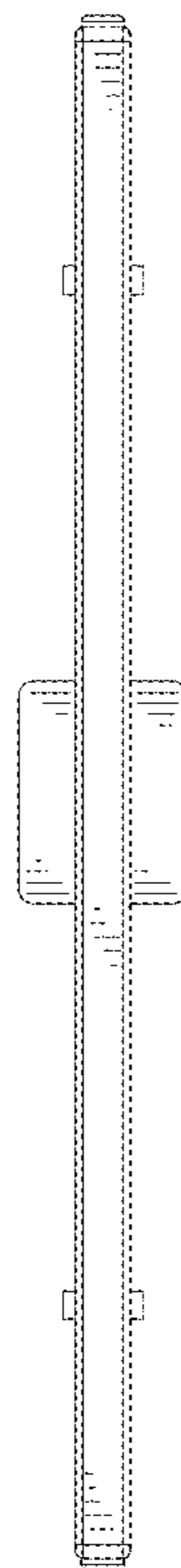

FIG. 4

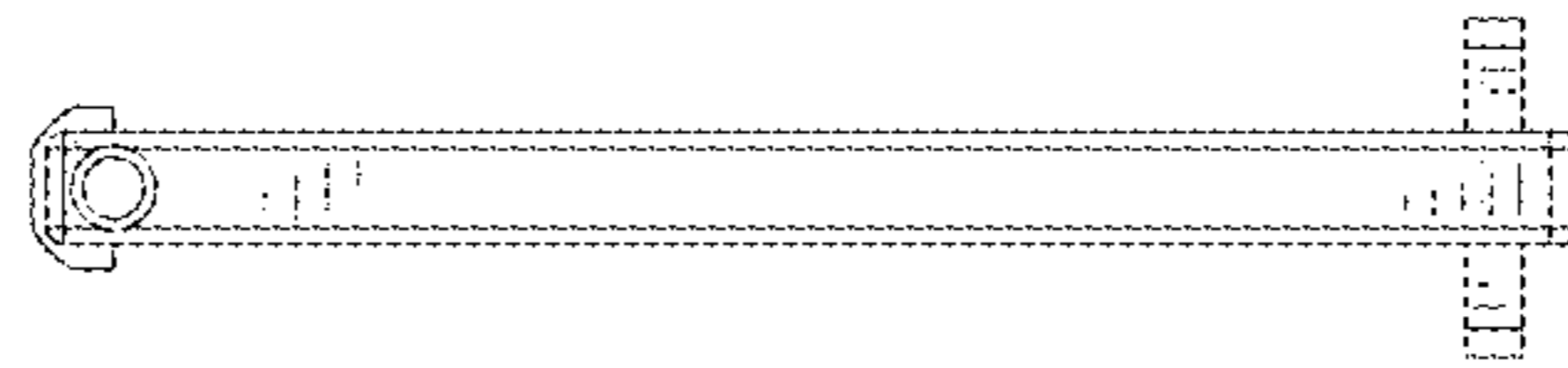

FIG. 5

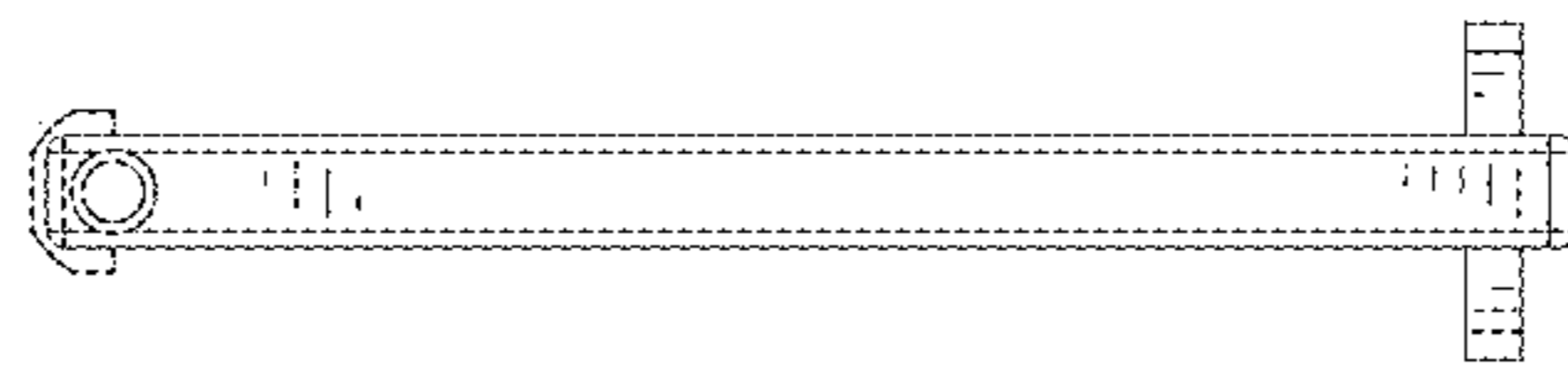

FIG. 6

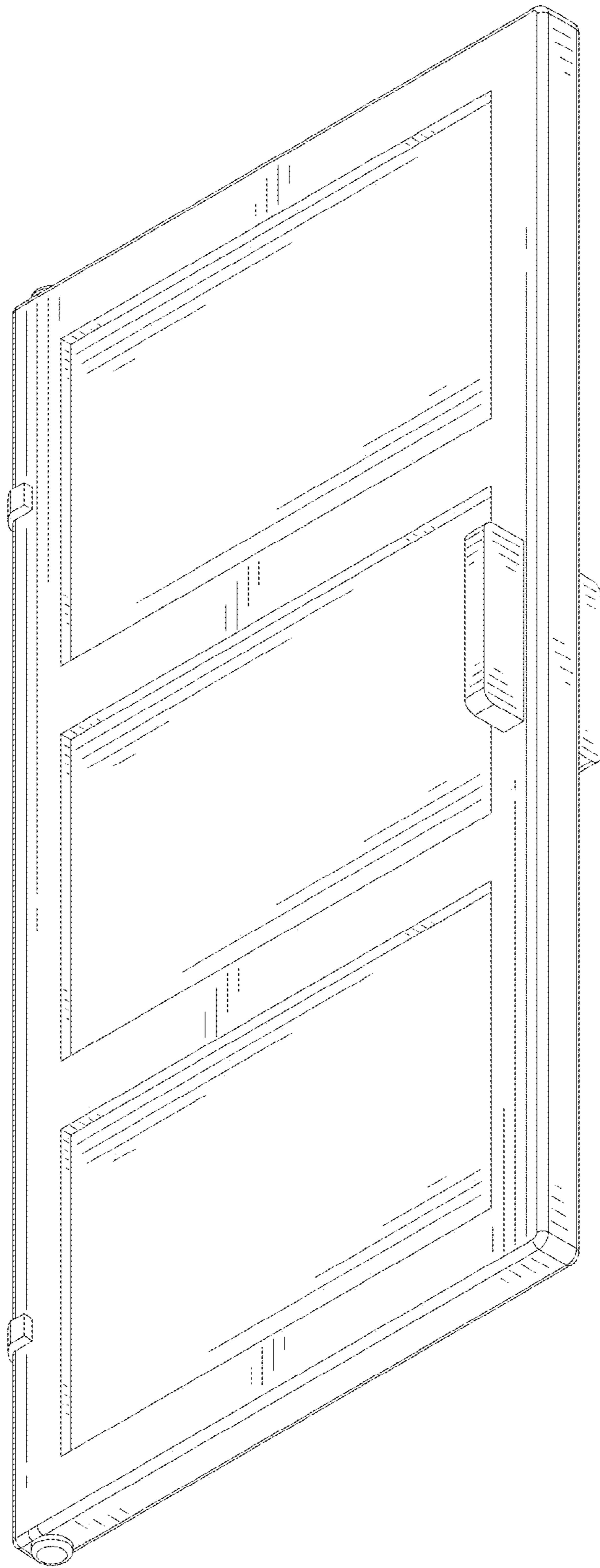

FIG. 7

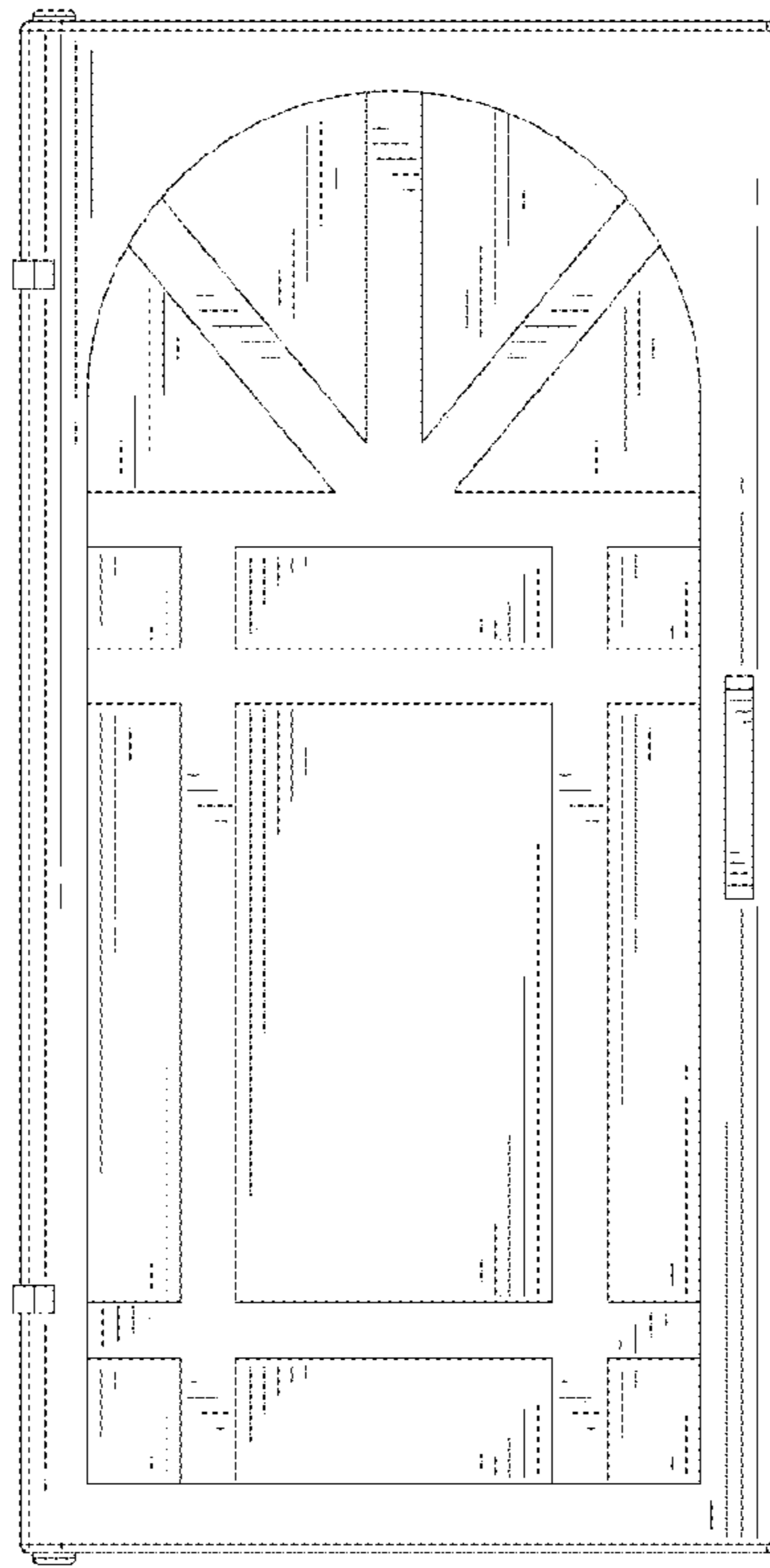

FIG. 8

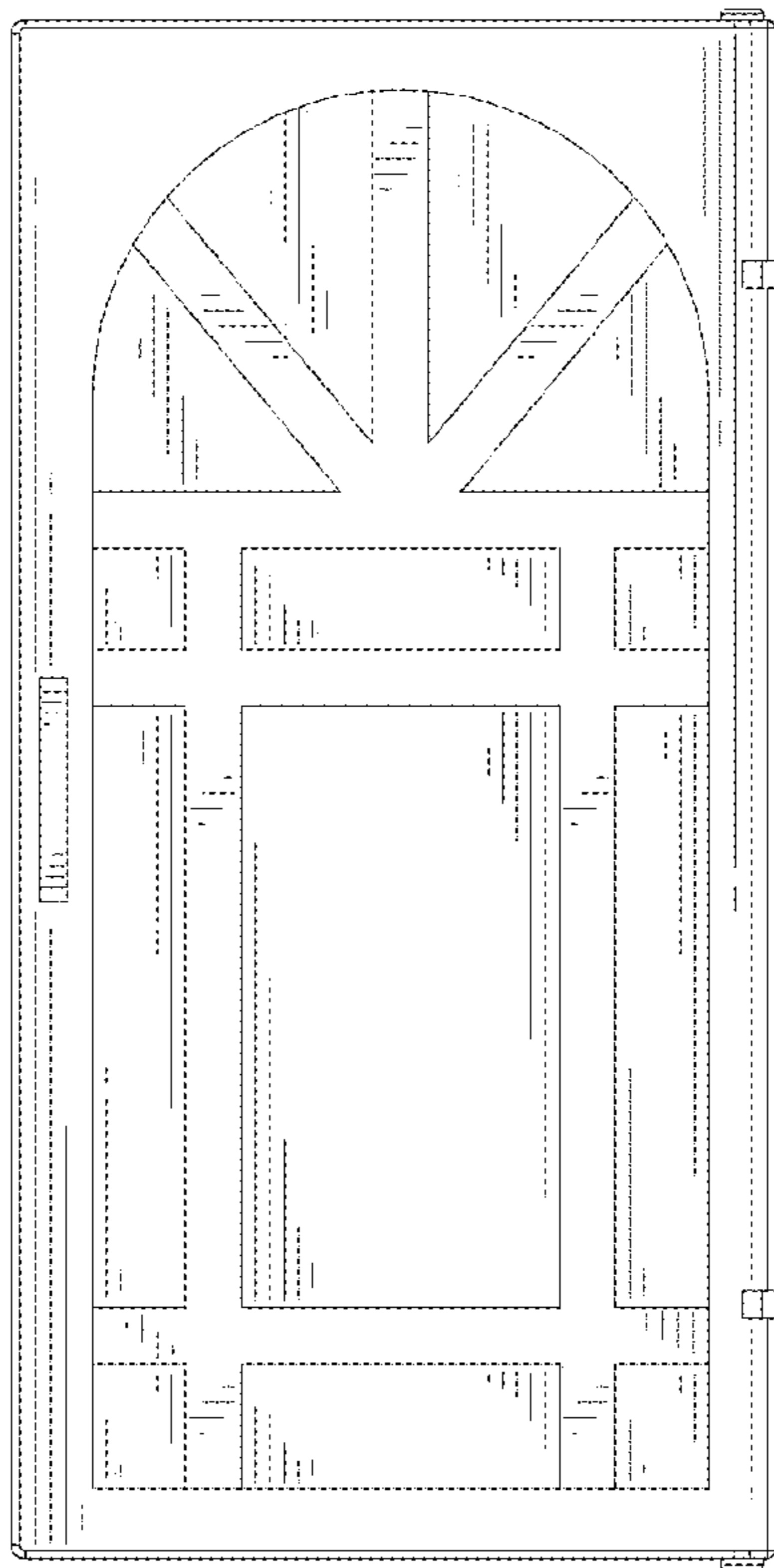

FIG. 9





FIG. 10

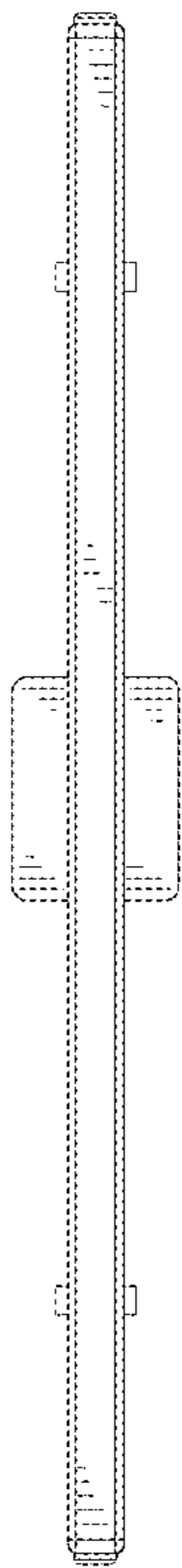

FIG. 11

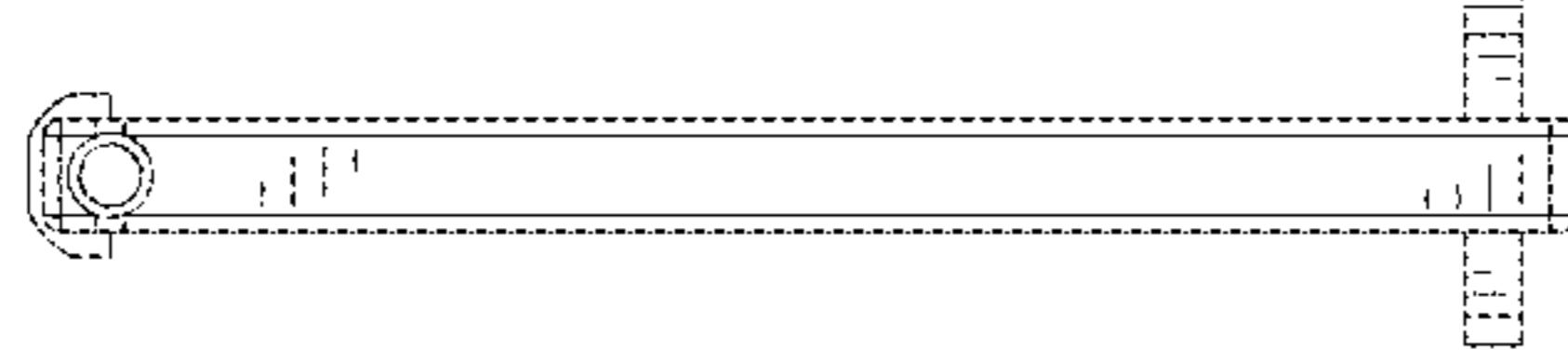

FIG. 12

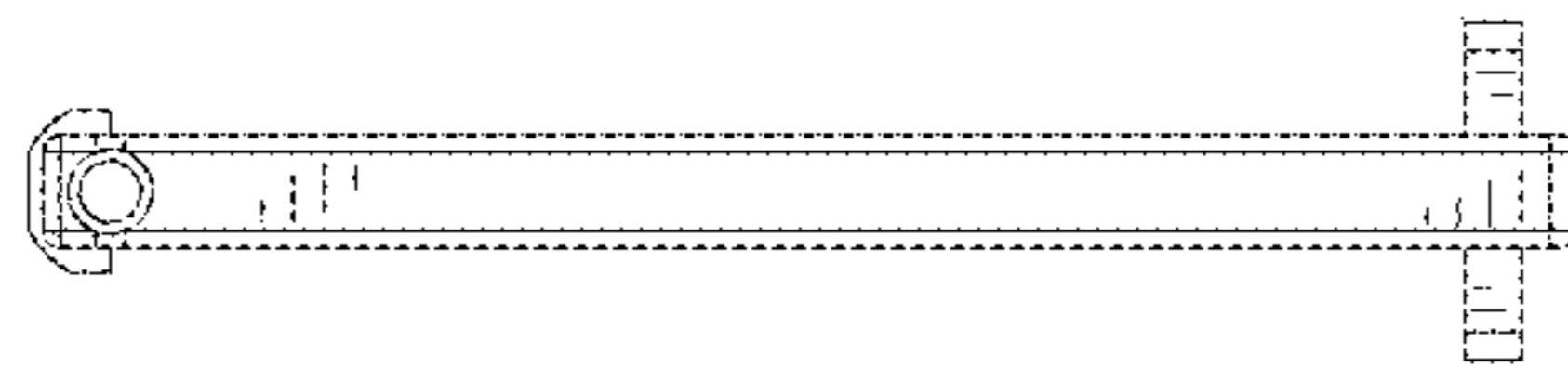

FIG. 13

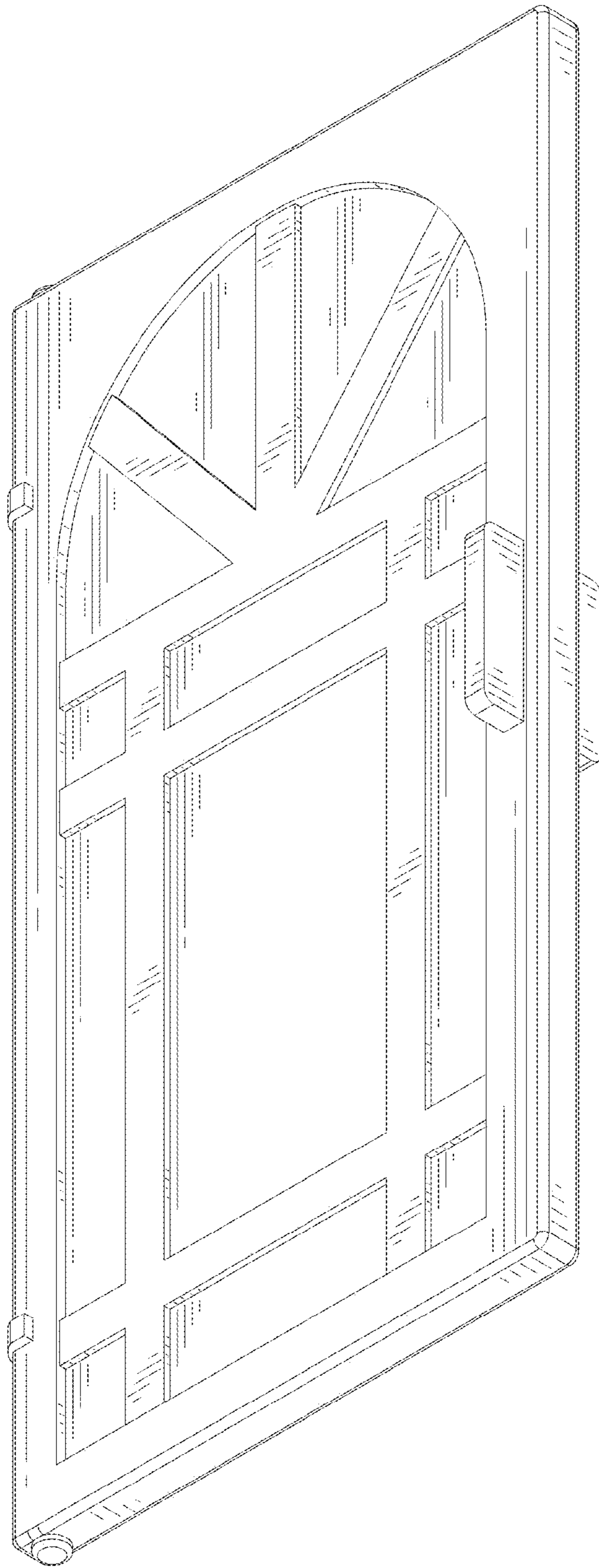

FIG. 14

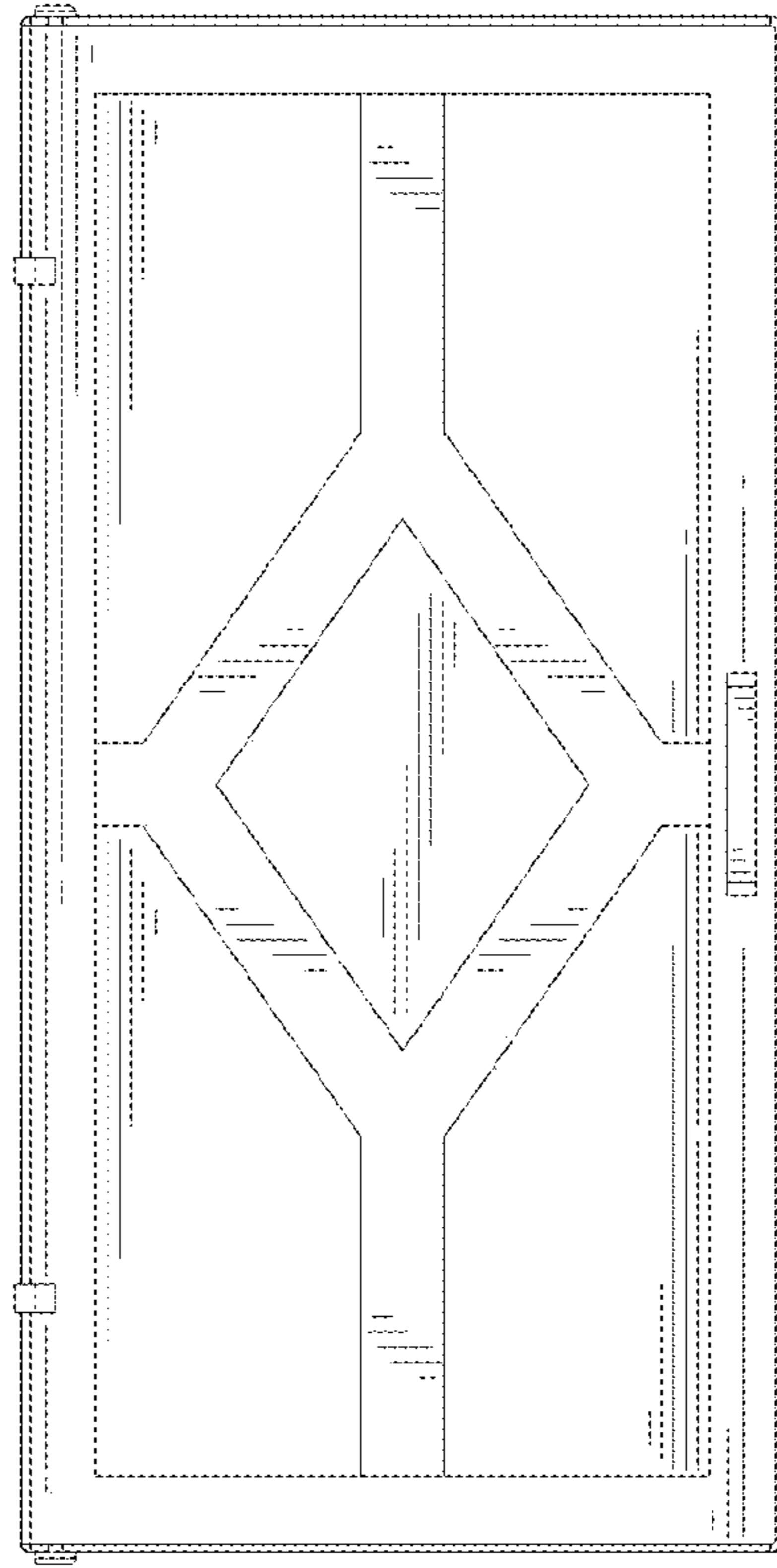

FIG. 15

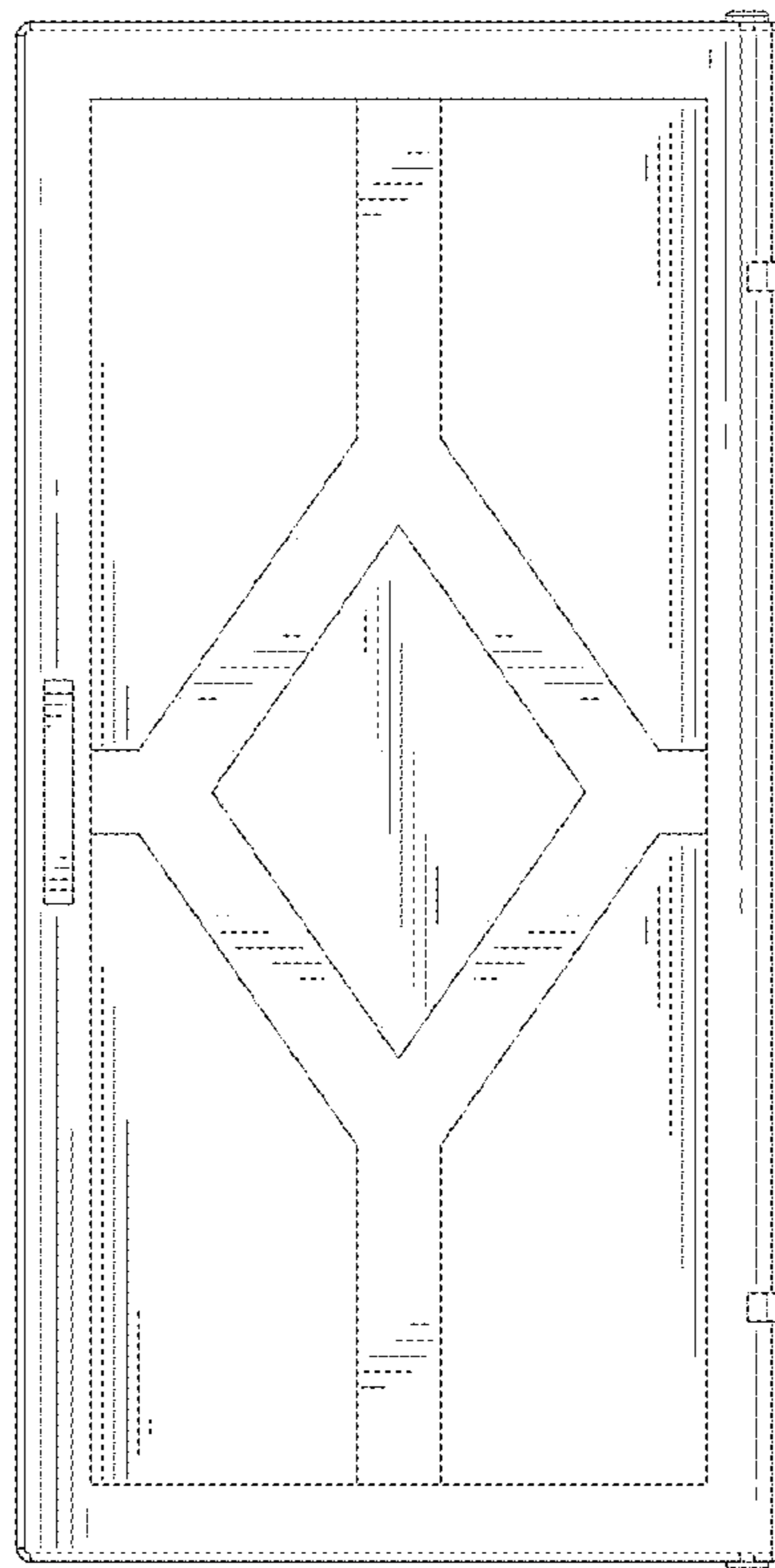

FIG. 16

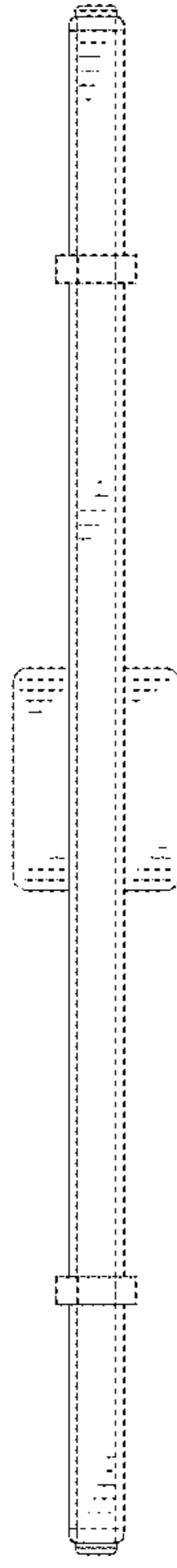

FIG. 17

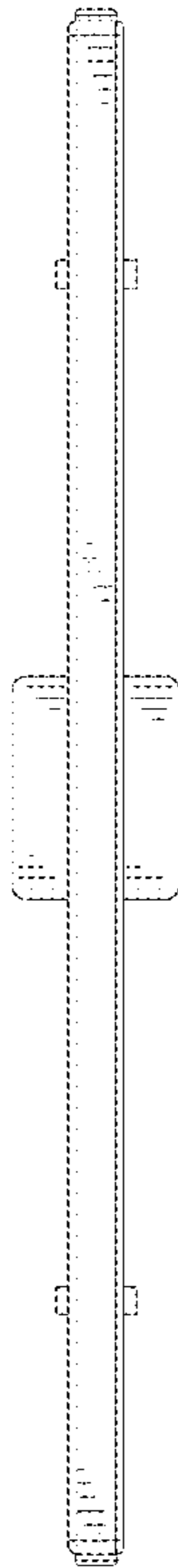

FIG. 18

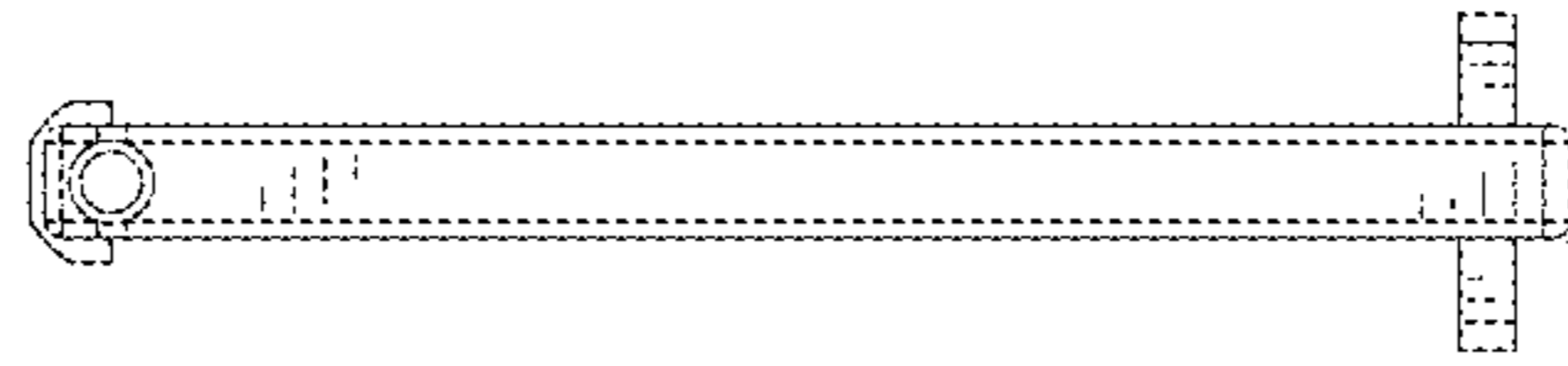

FIG. 19

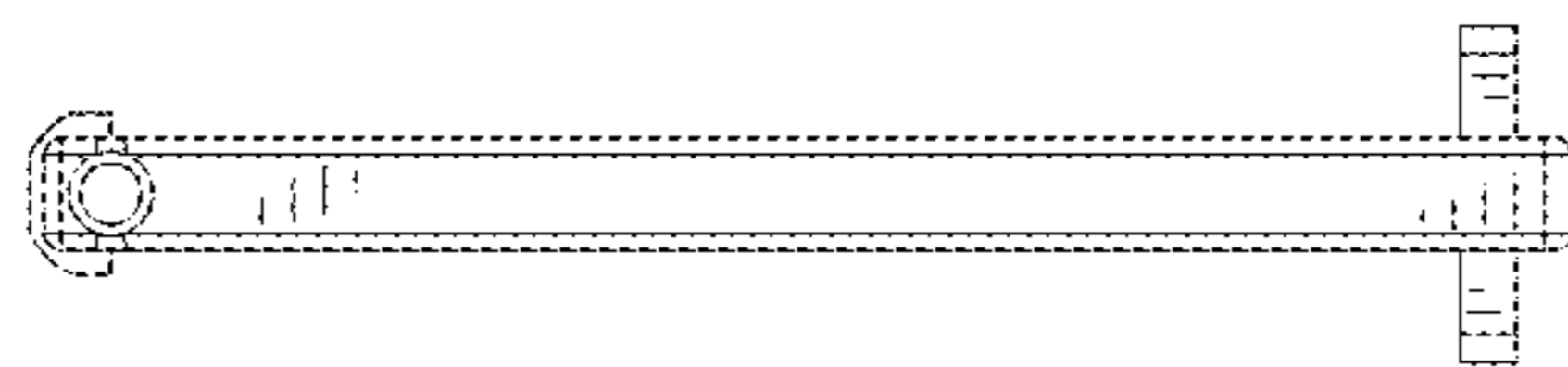

FIG. 20

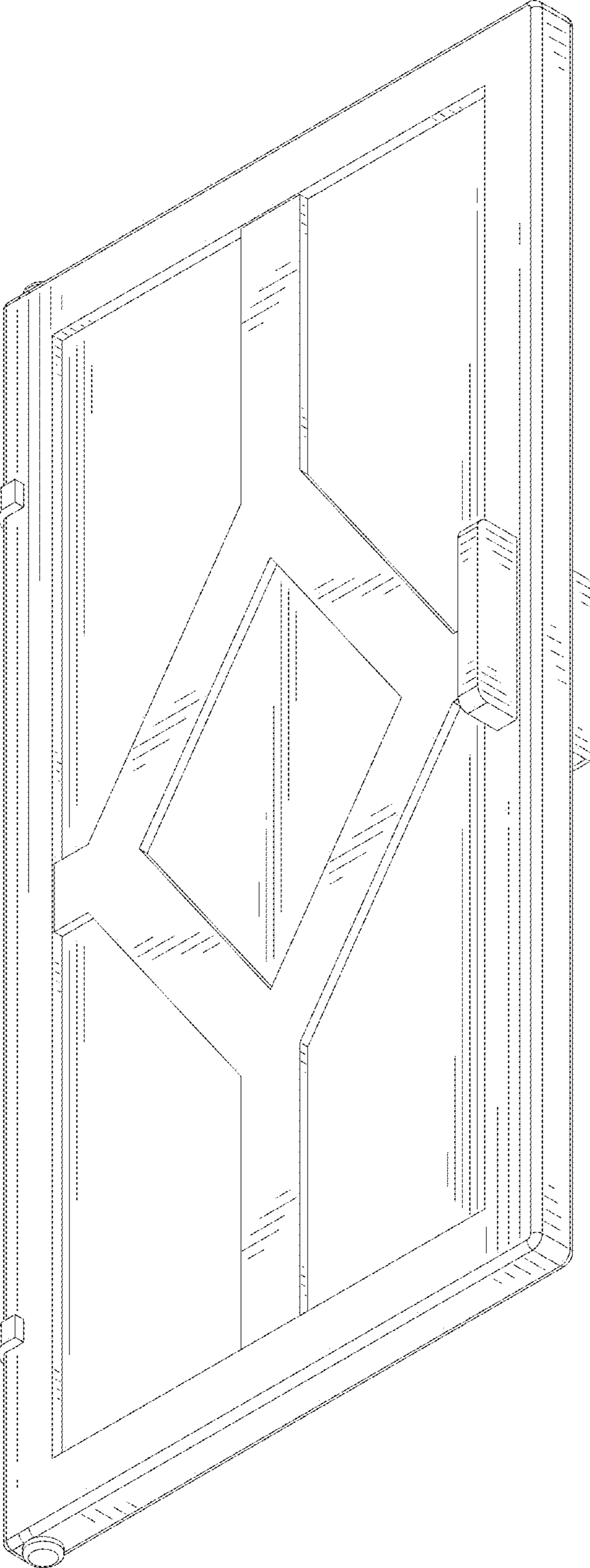

FIG. 21

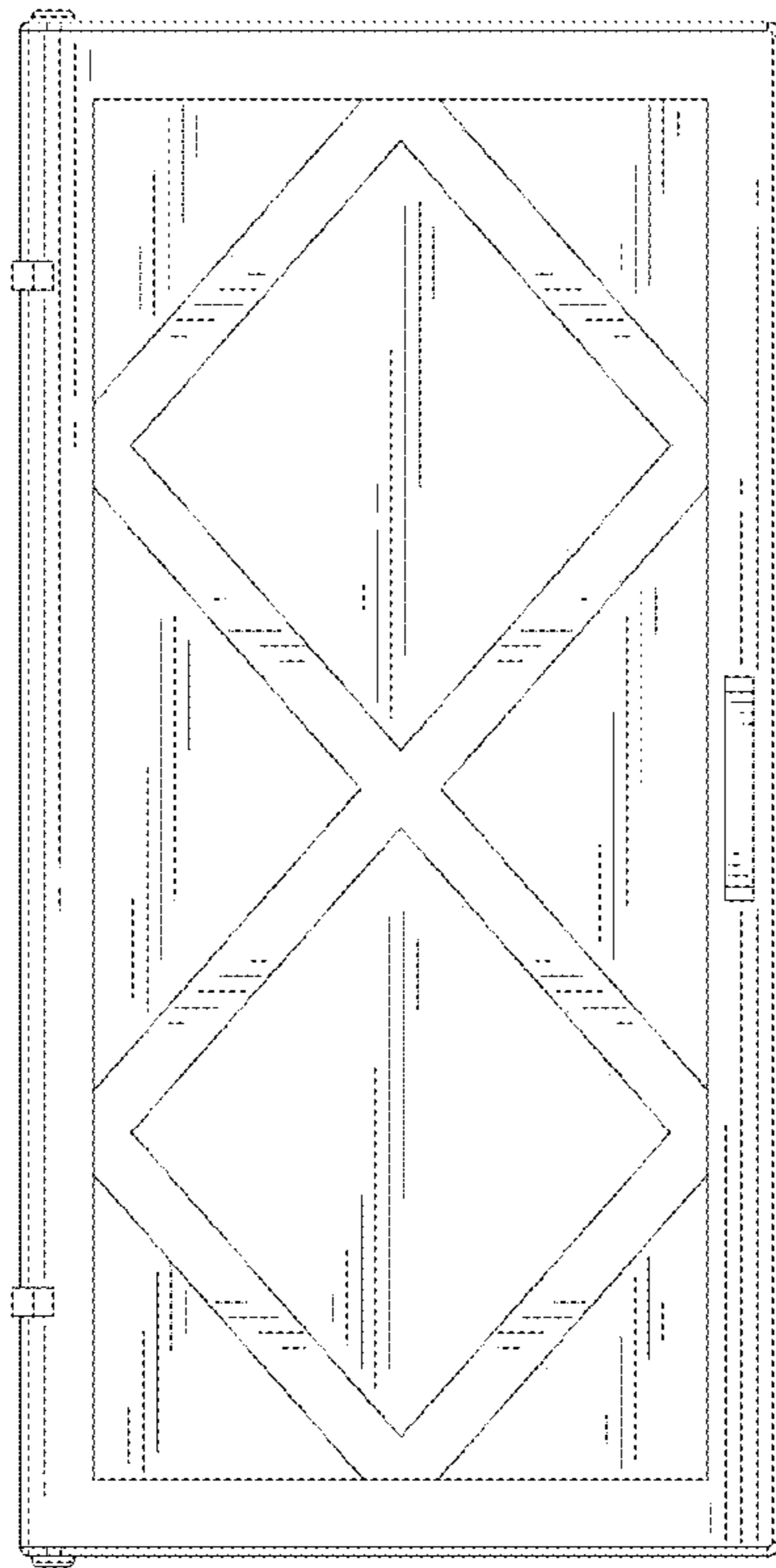

FIG. 22

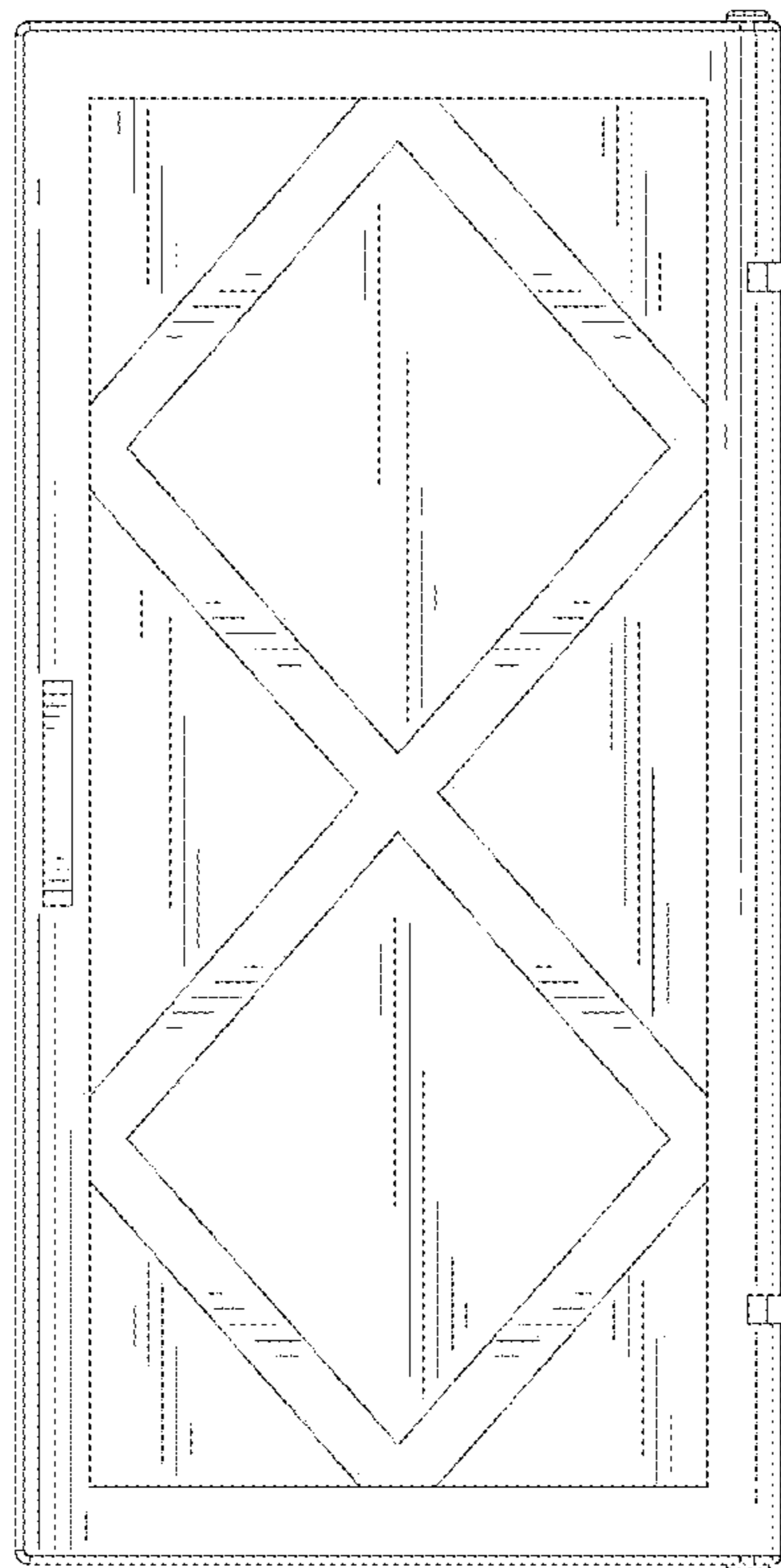

FIG. 23



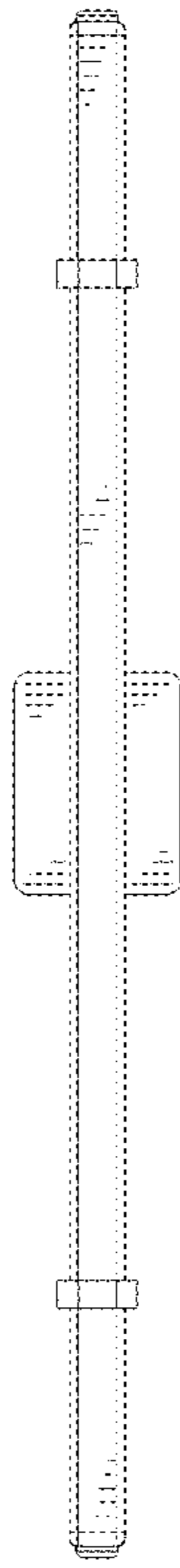

FIG. 24

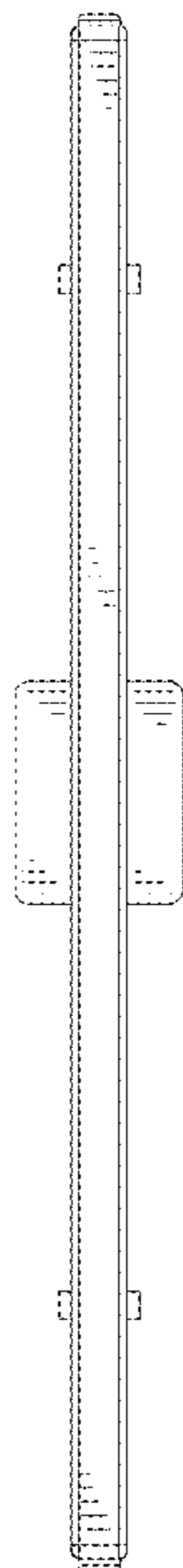

FIG. 25

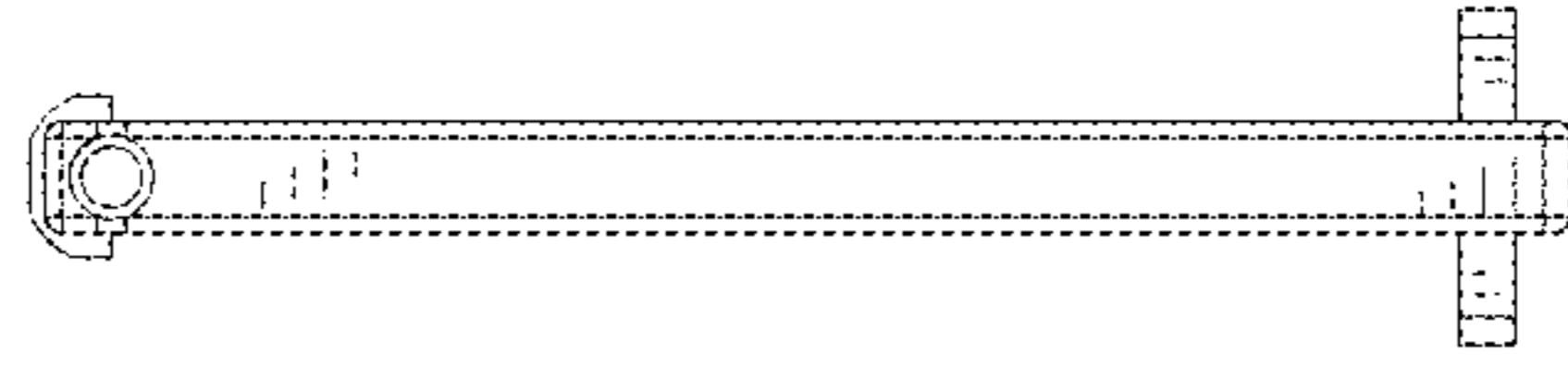

FIG. 26

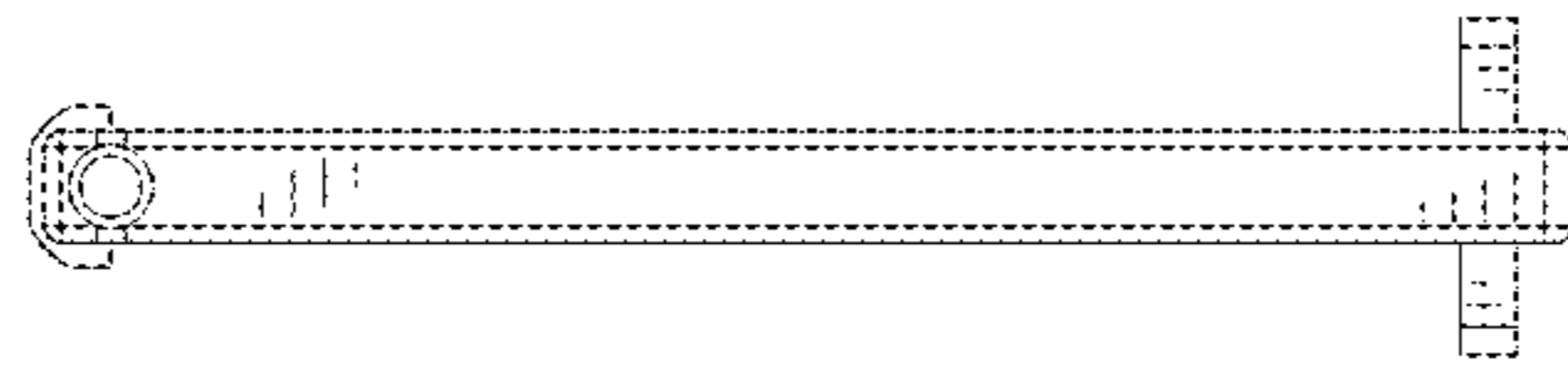

FIG. 27

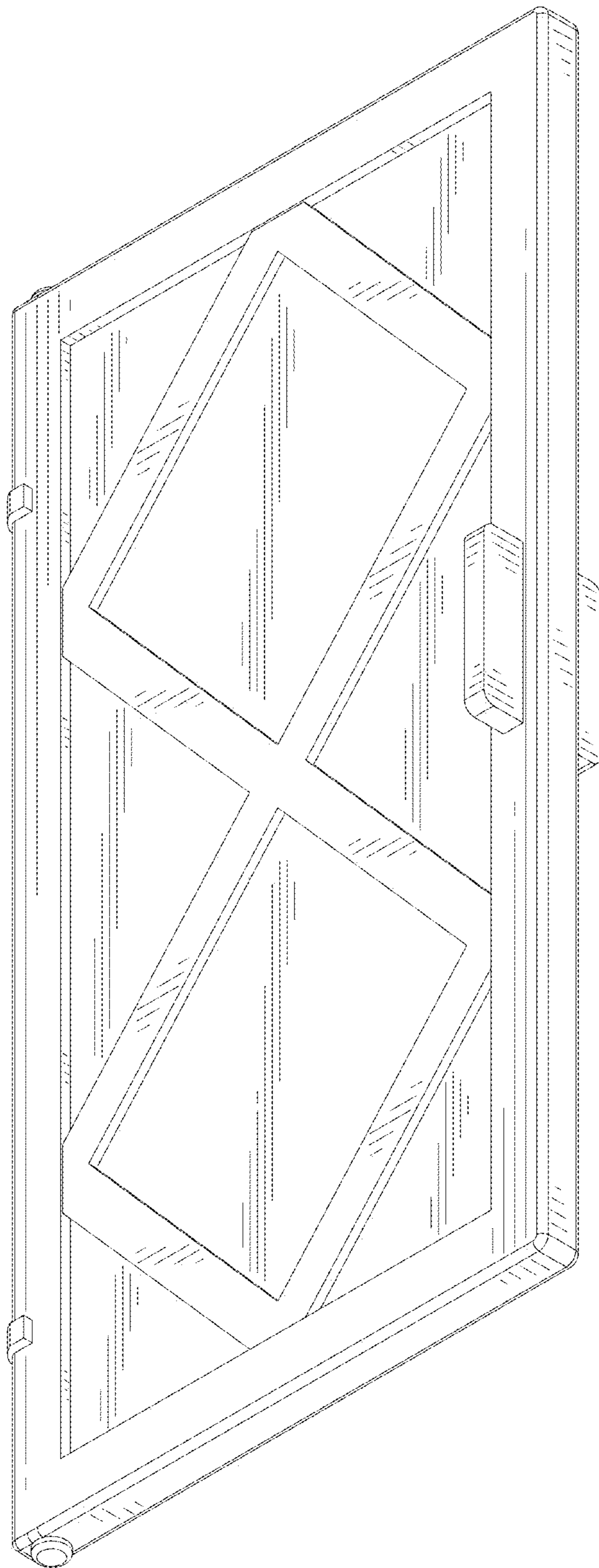

FIG. 28

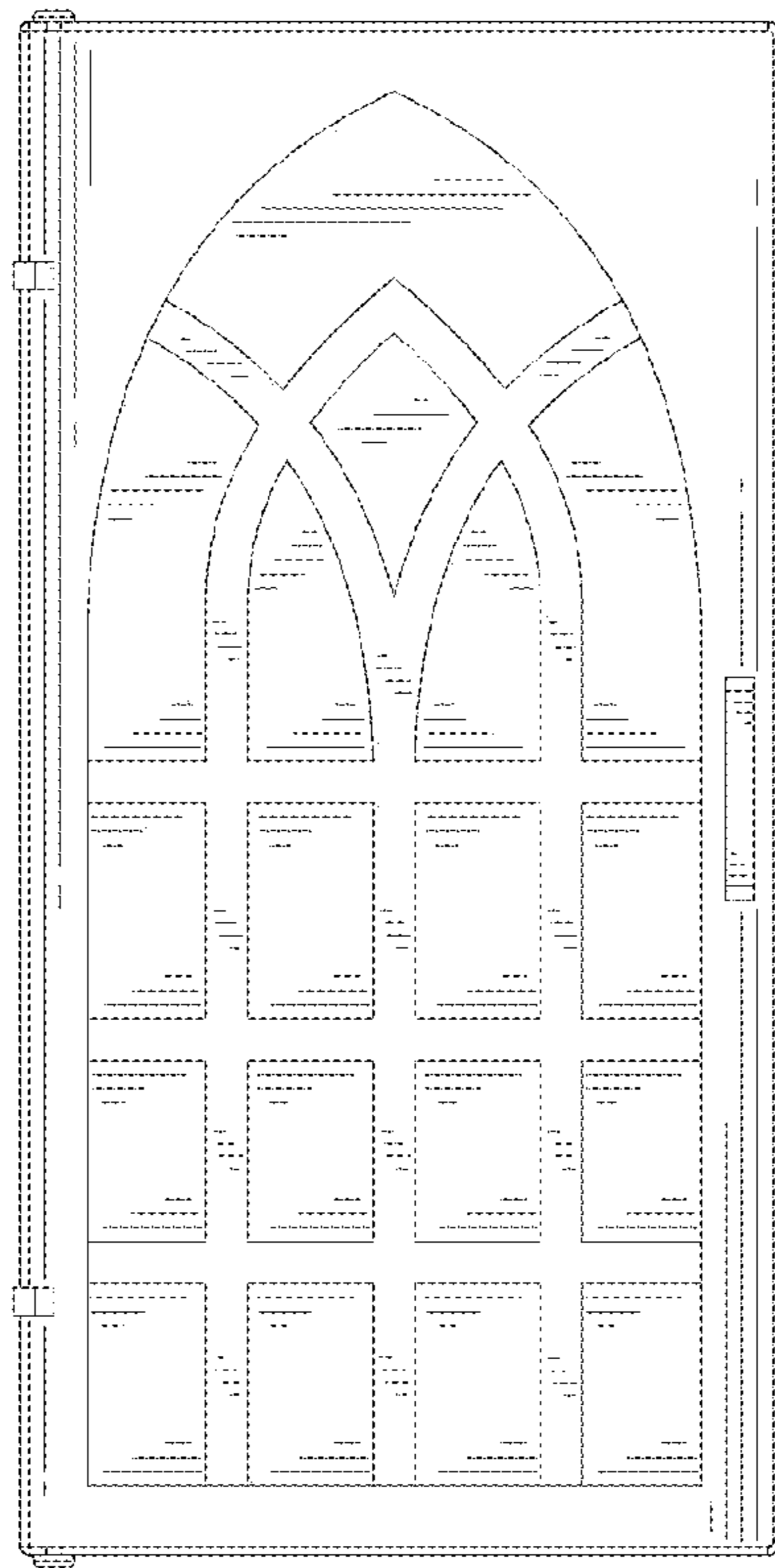

FIG. 29

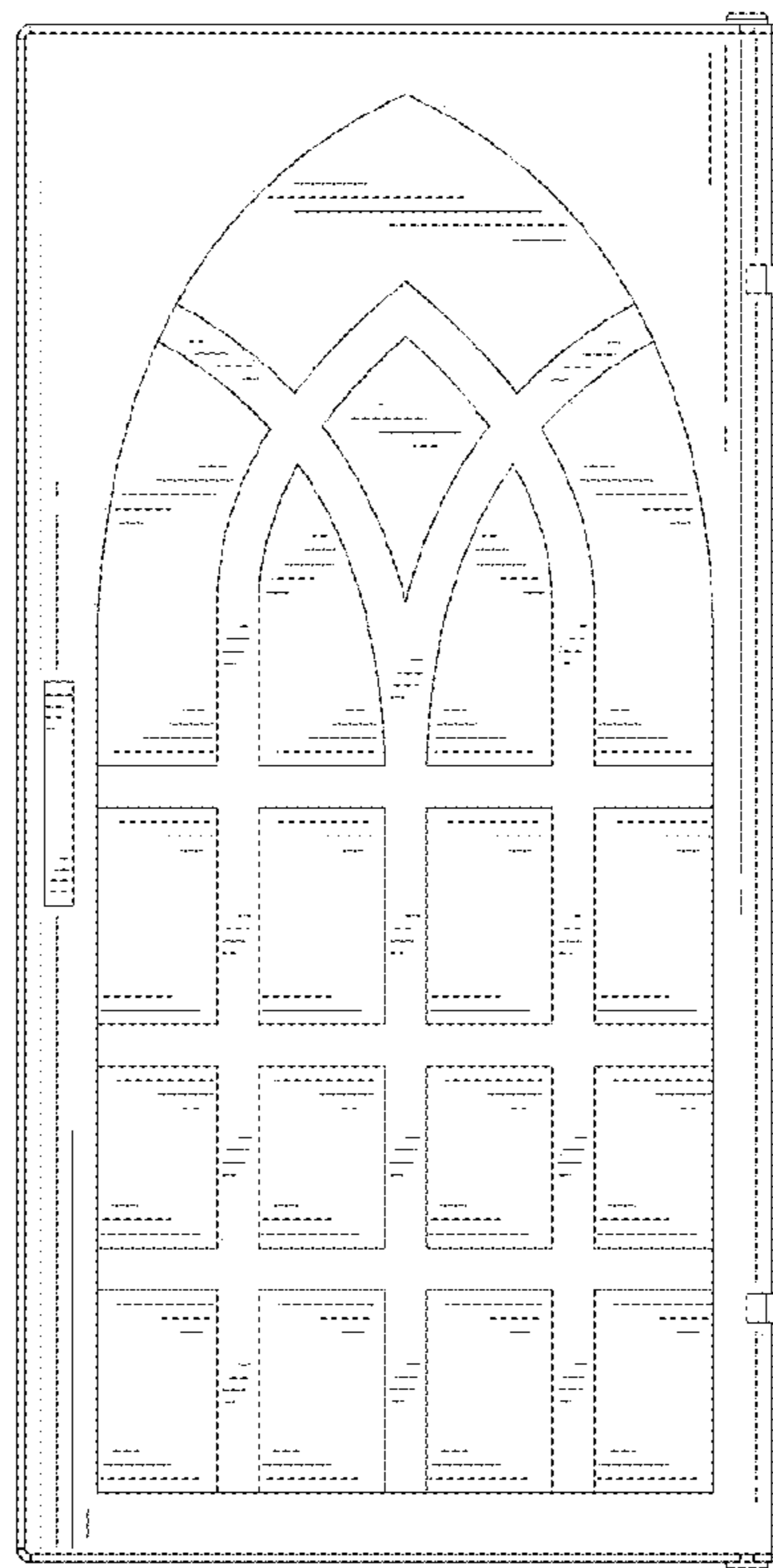

FIG. 30



FIG. 31

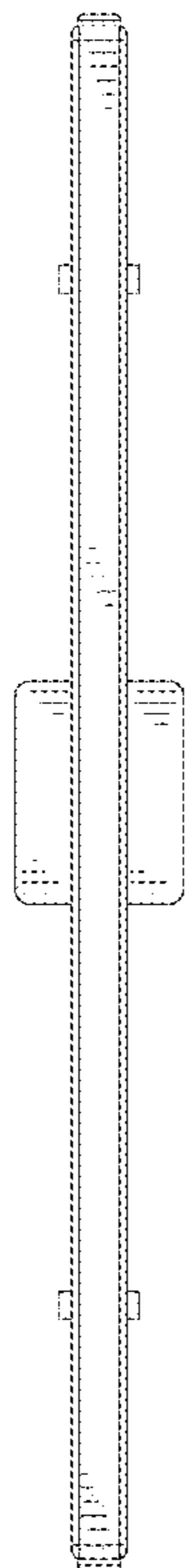

FIG. 32

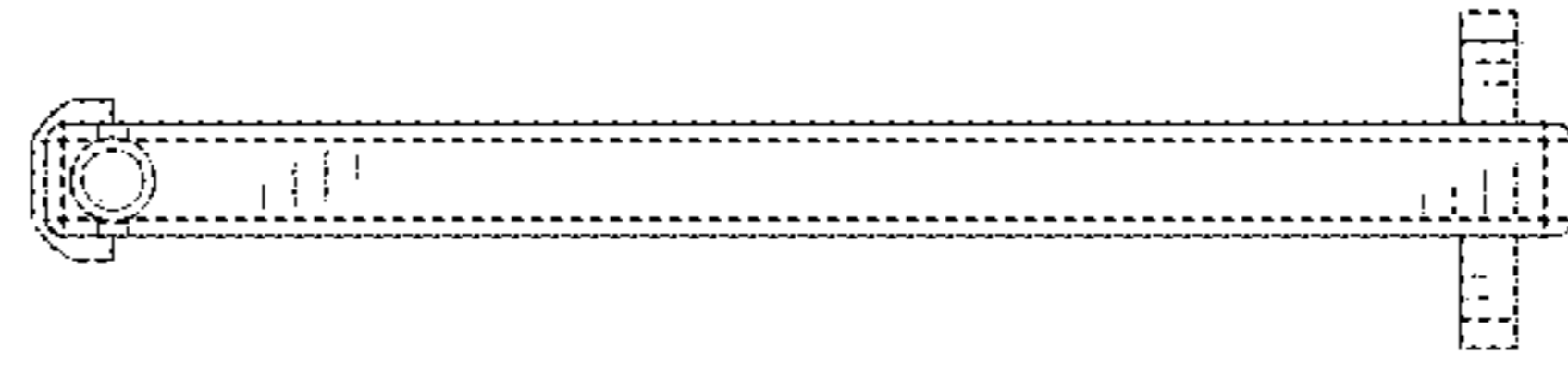

FIG. 33

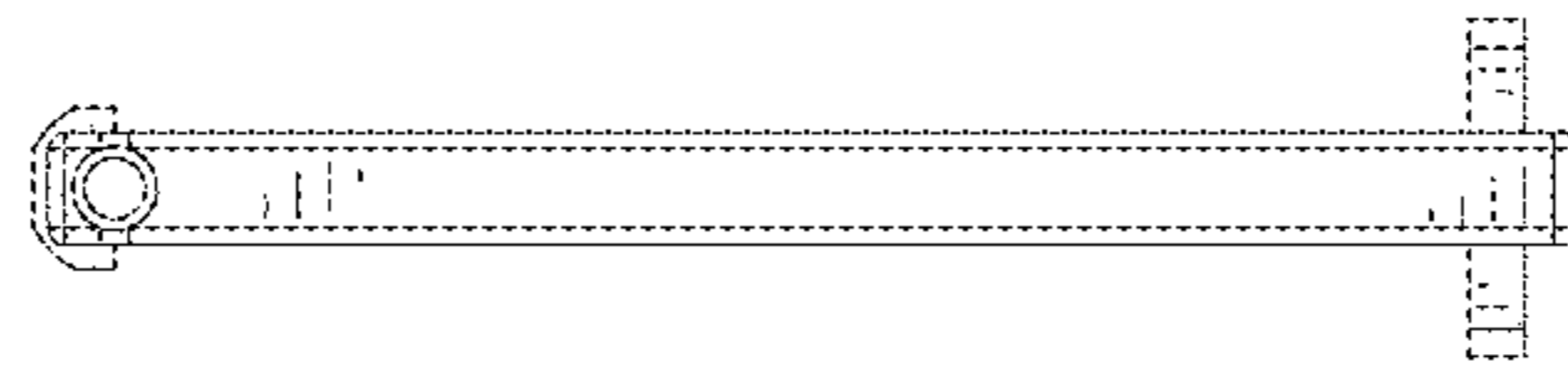

FIG. 34

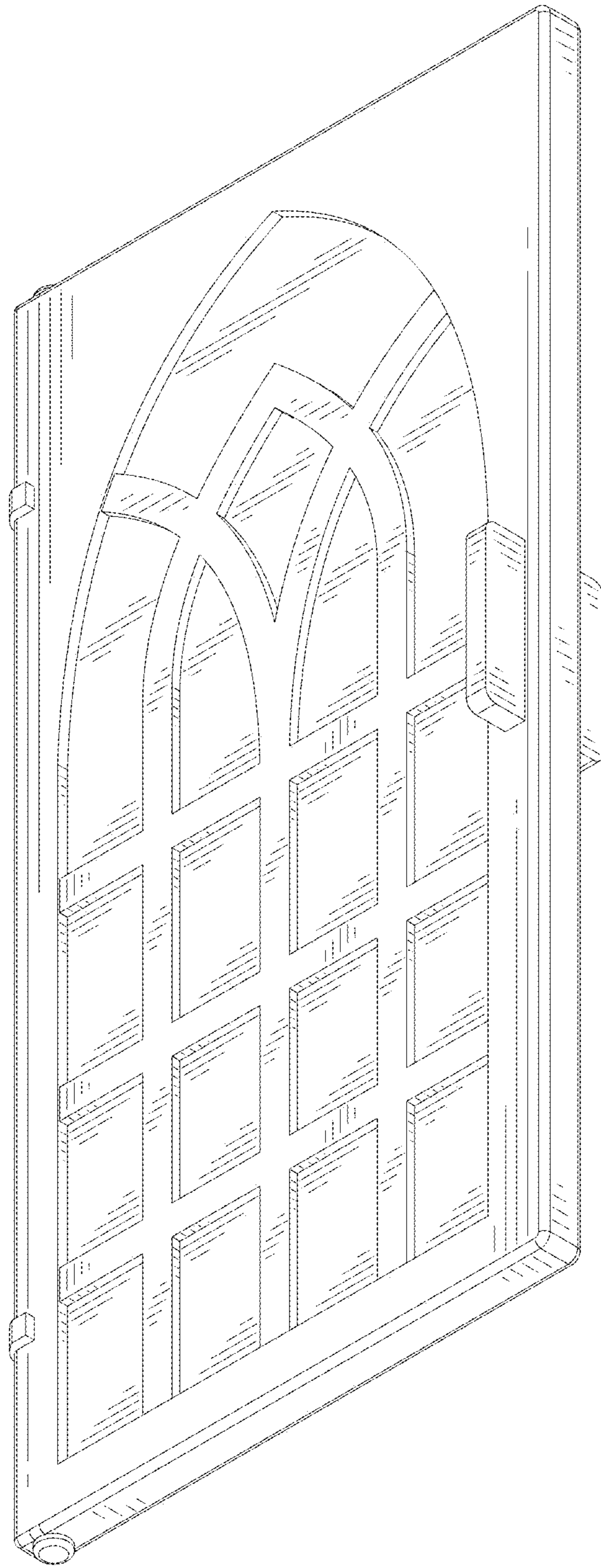

FIG. 35

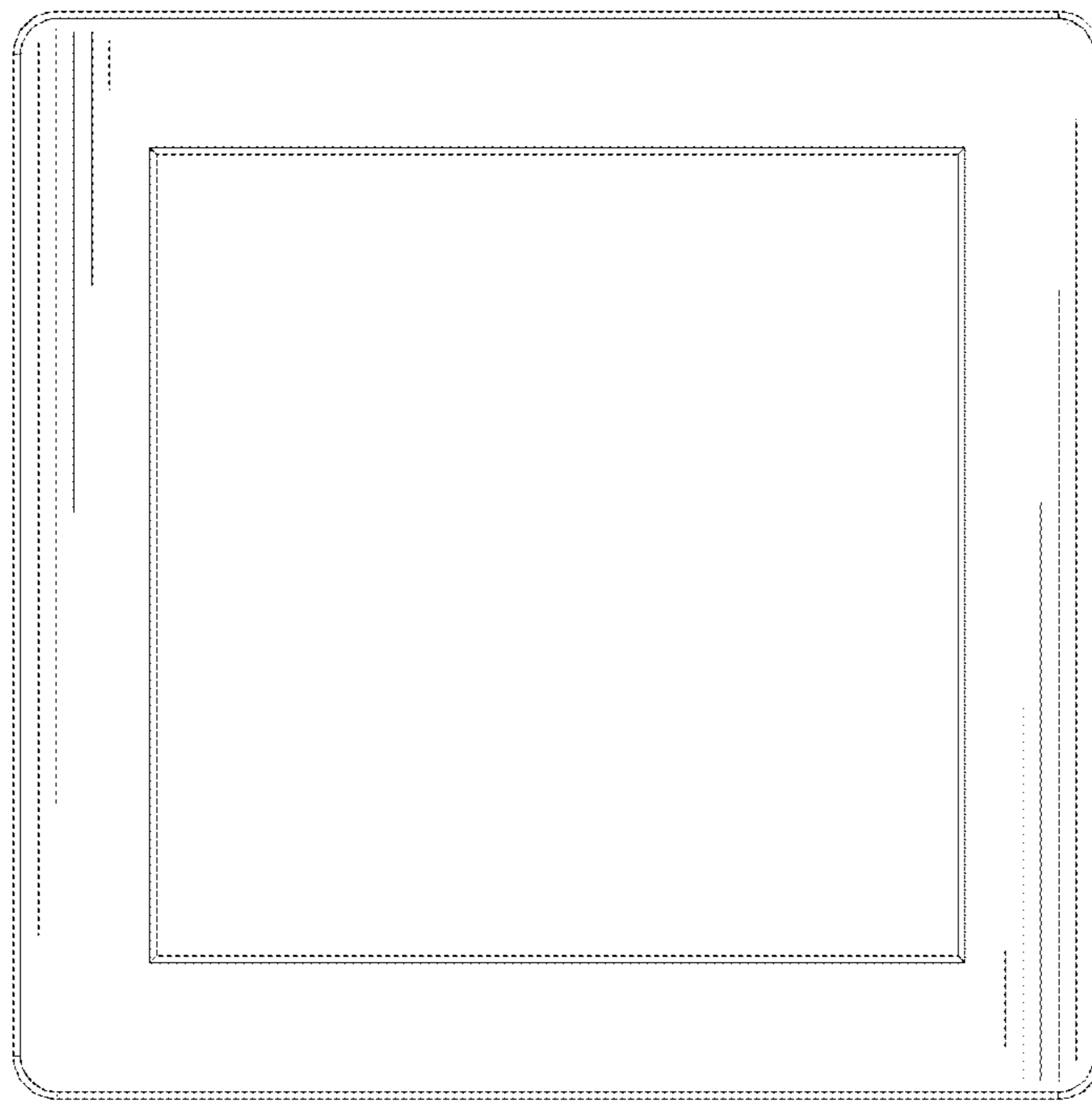

FIG. 36

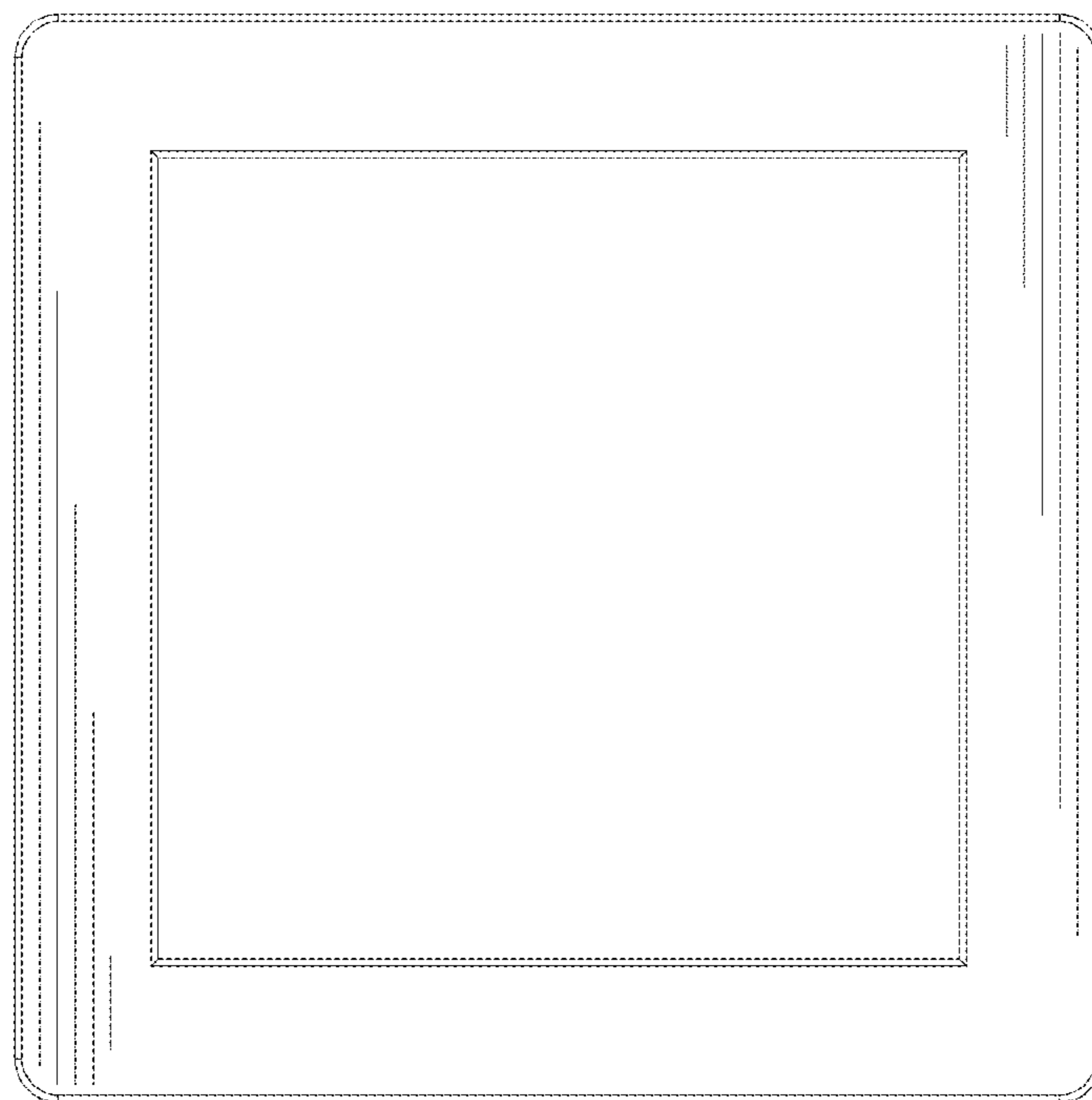

FIG. 37



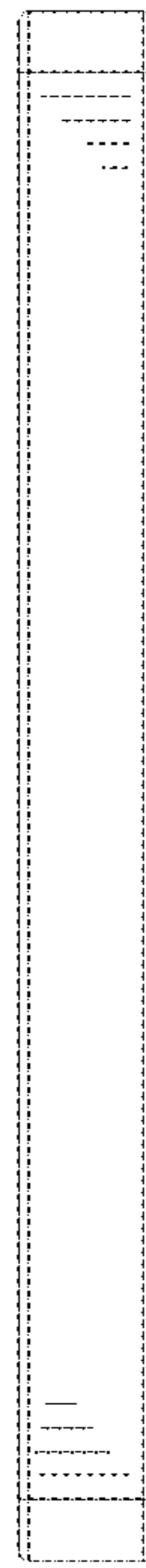

FIG. 38

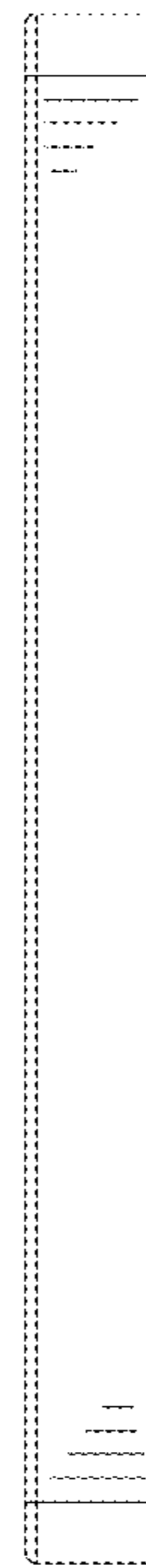

FIG. 39

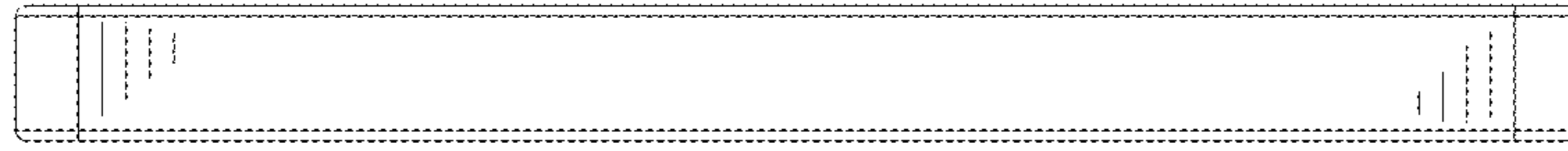

FIG. 40

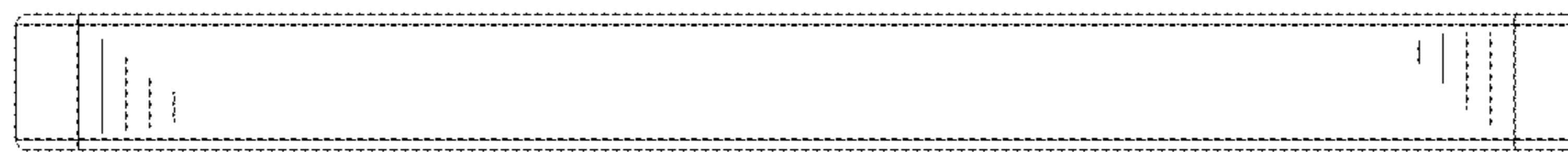

FIG. 41

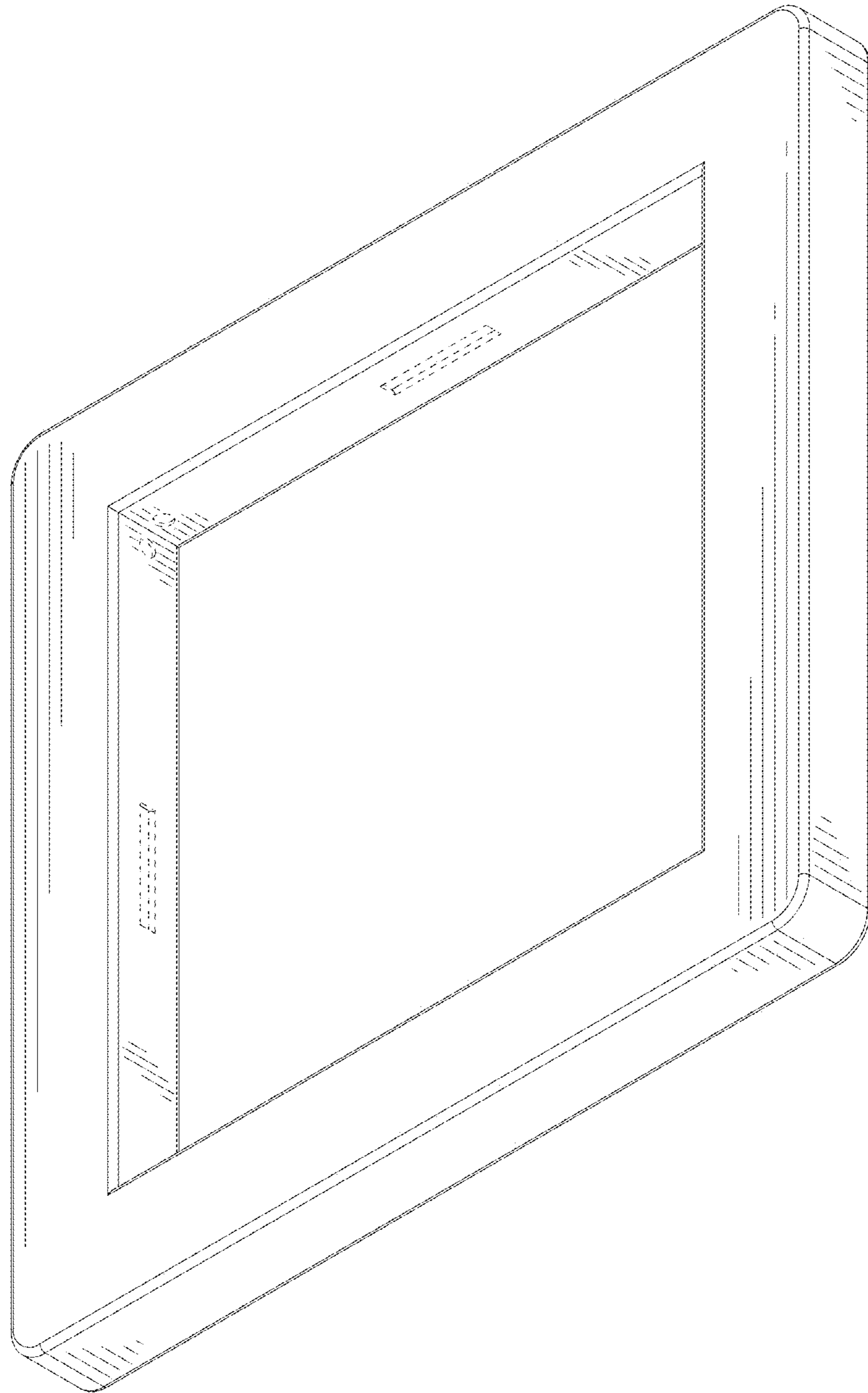

FIG. 42

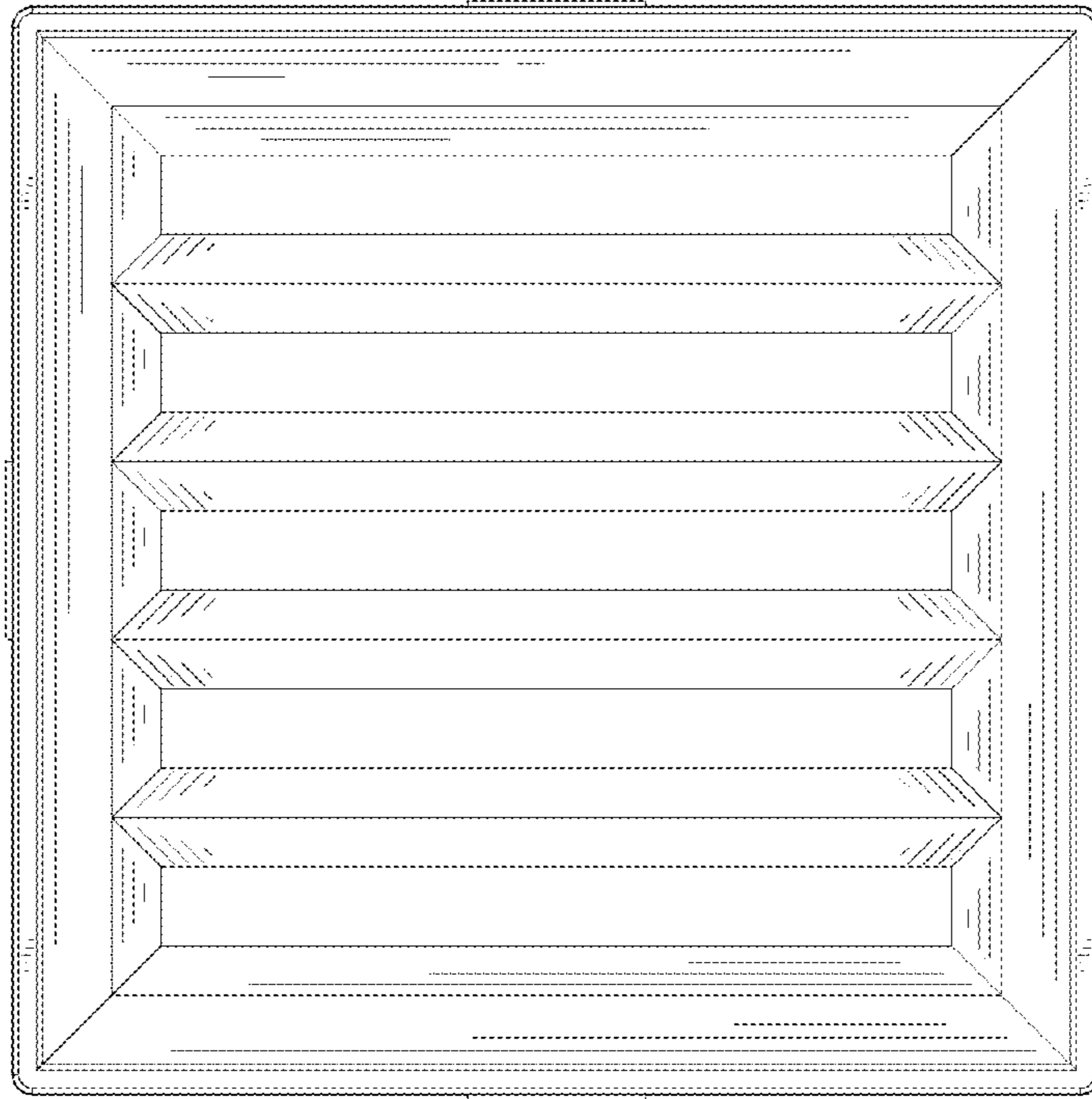

FIG. 43

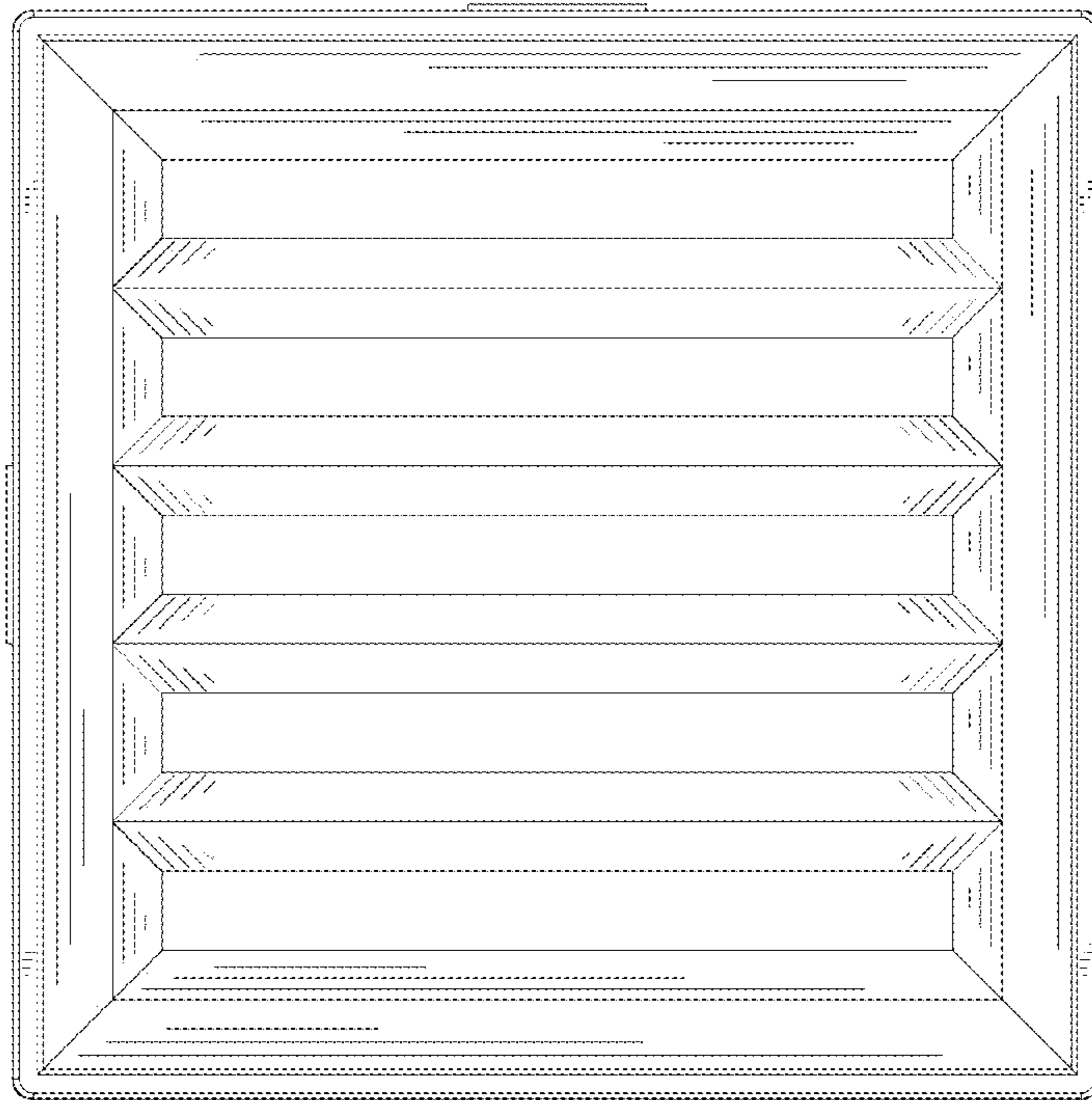

FIG. 44

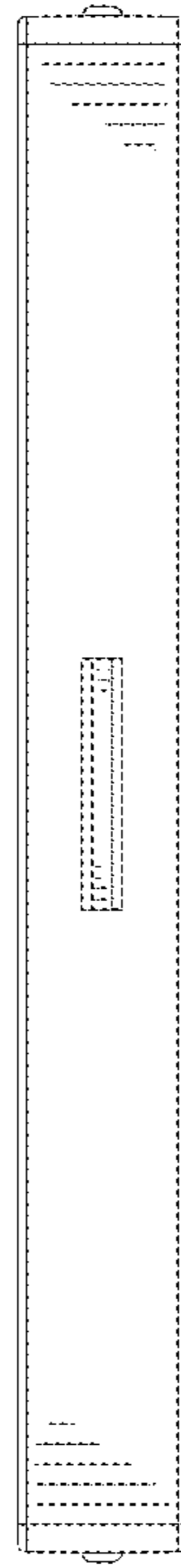

FIG. 45

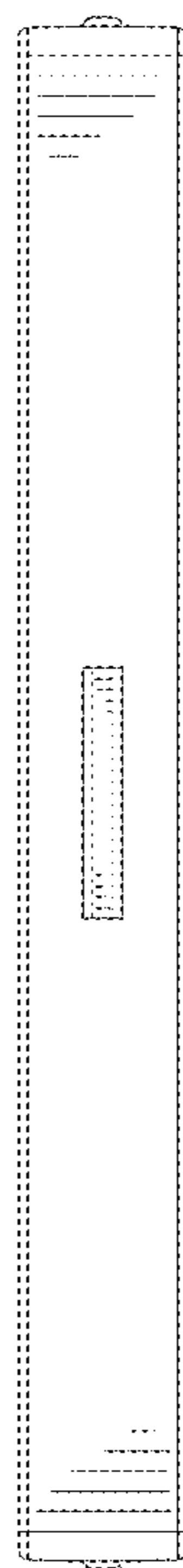

FIG. 46

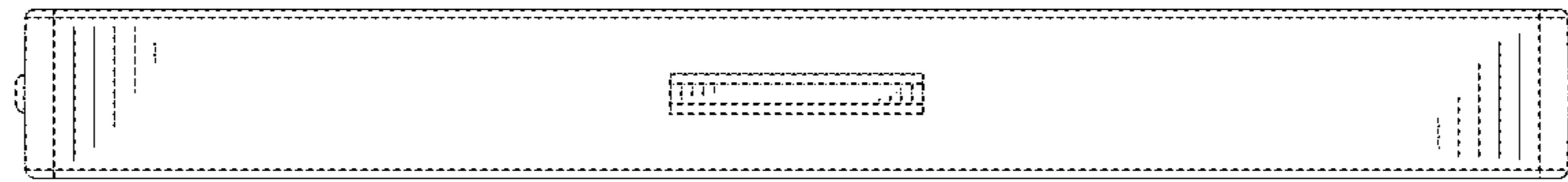

FIG. 47

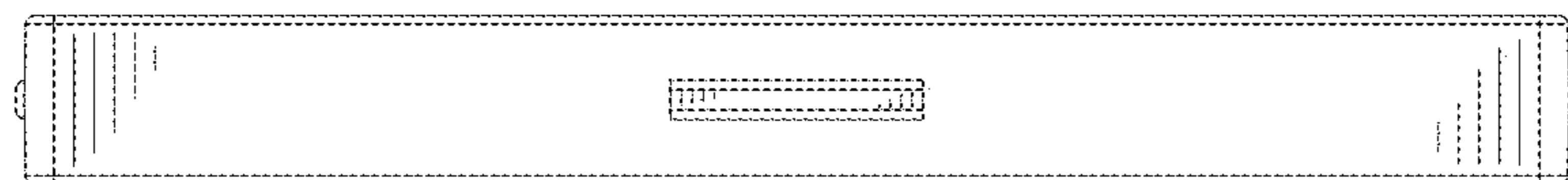

FIG. 48

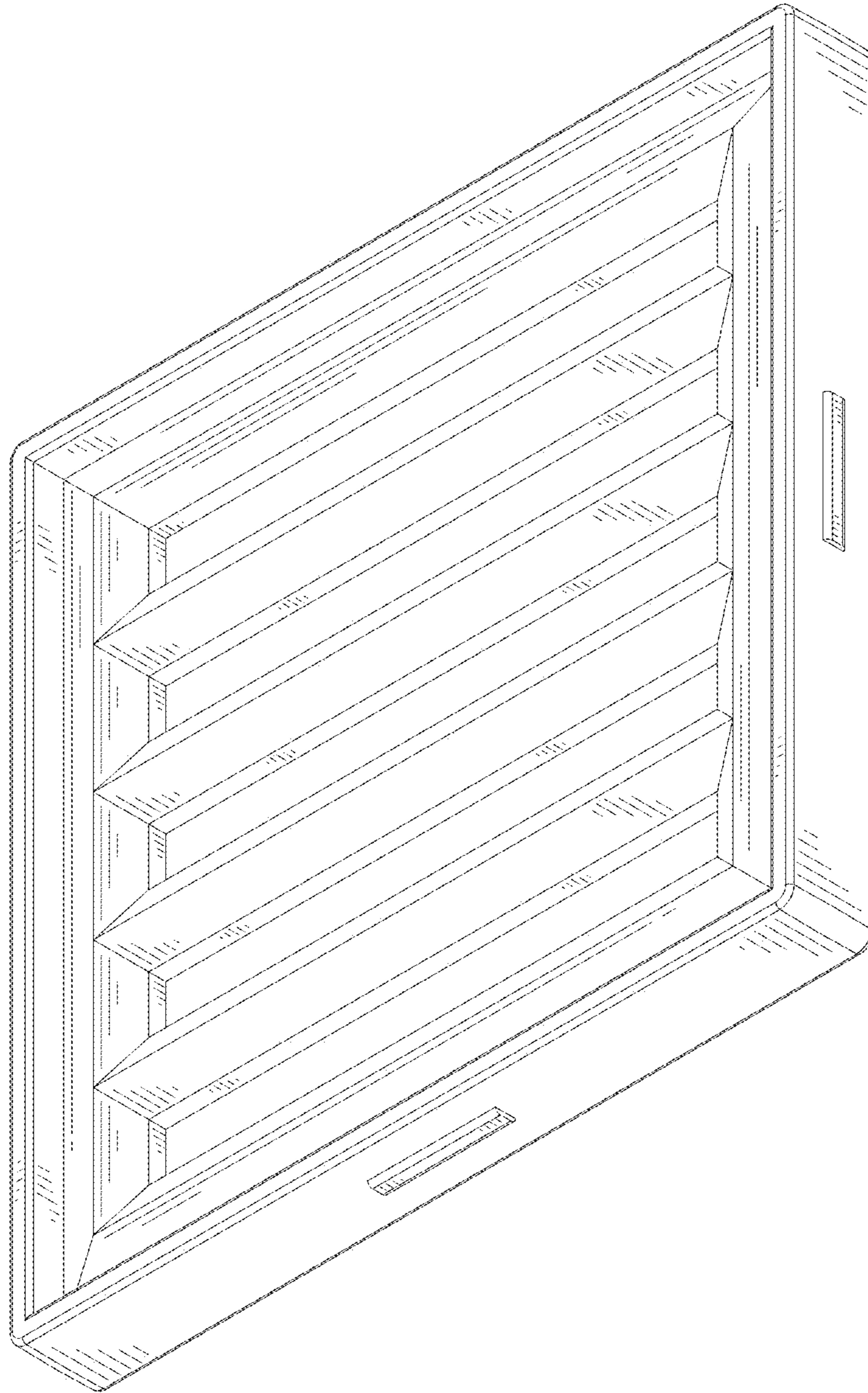

FIG. 49

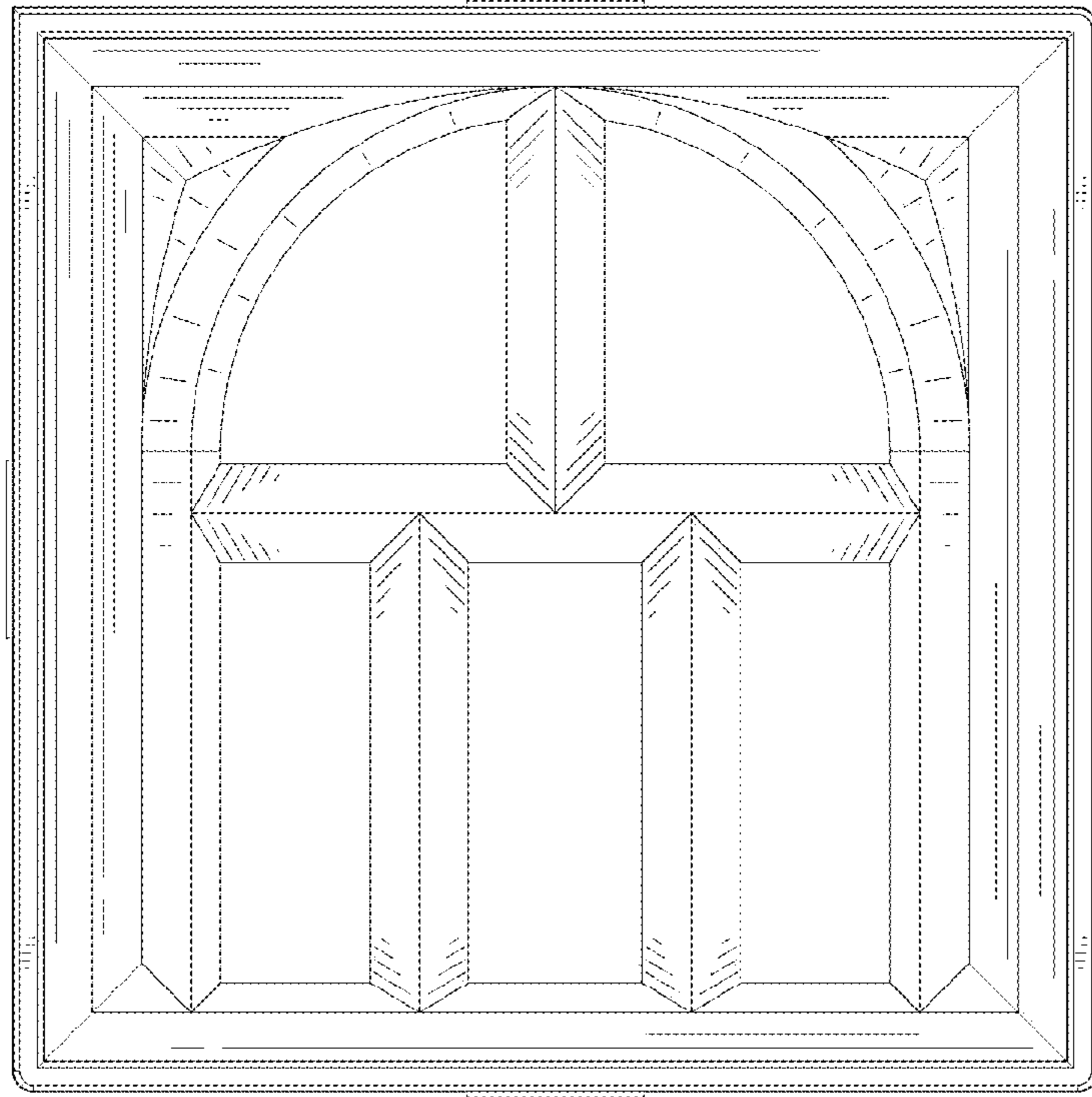

FIG. 50

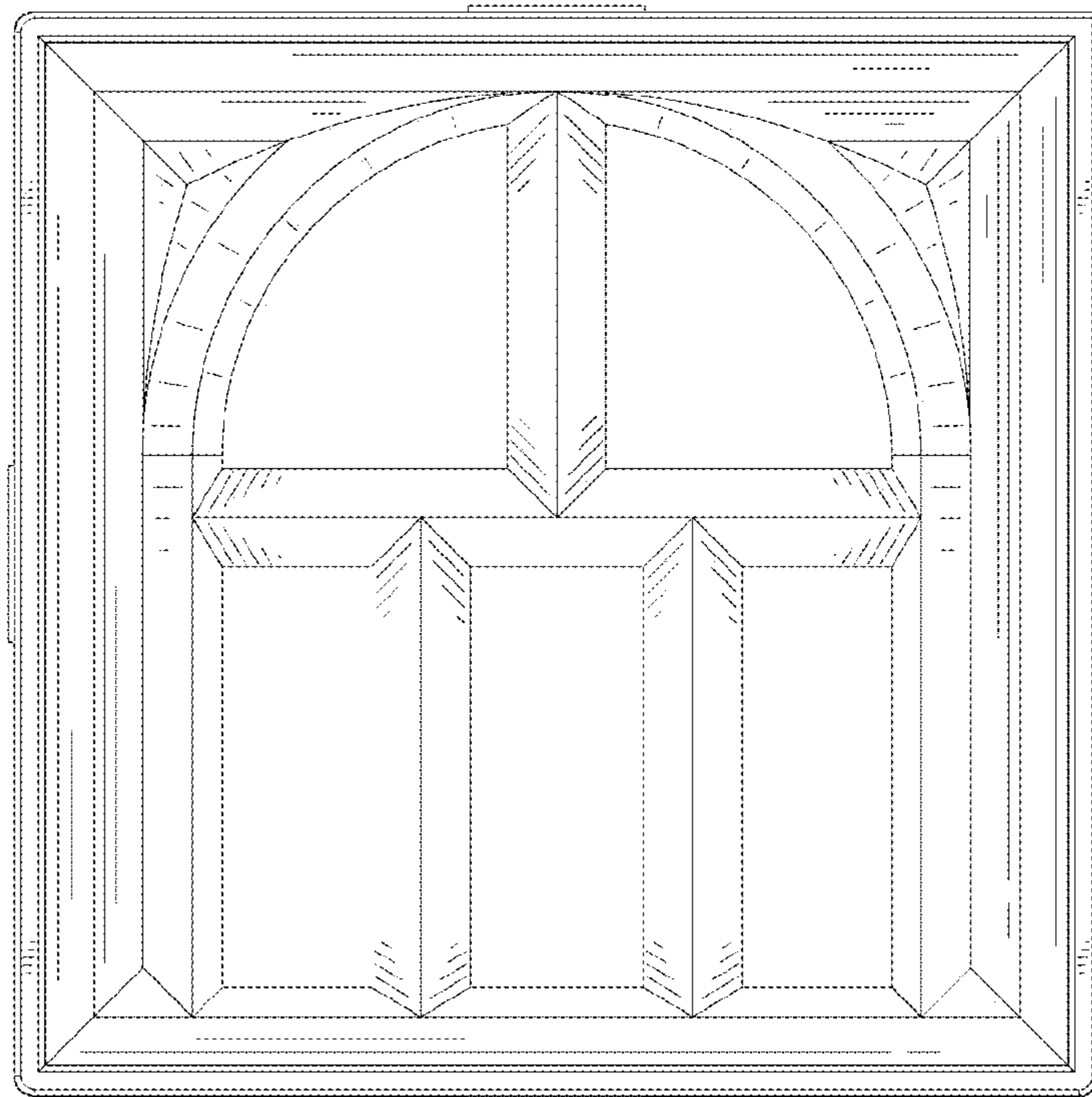

FIG. 51



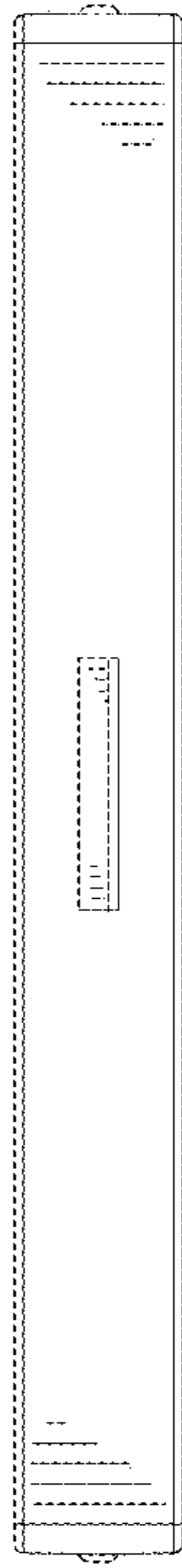

FIG. 52

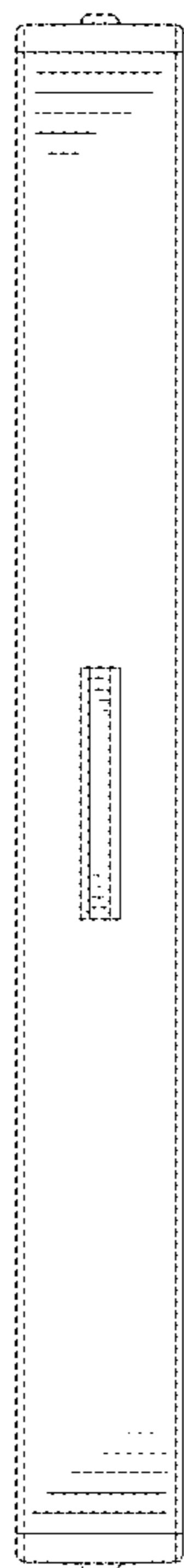

FIG. 53

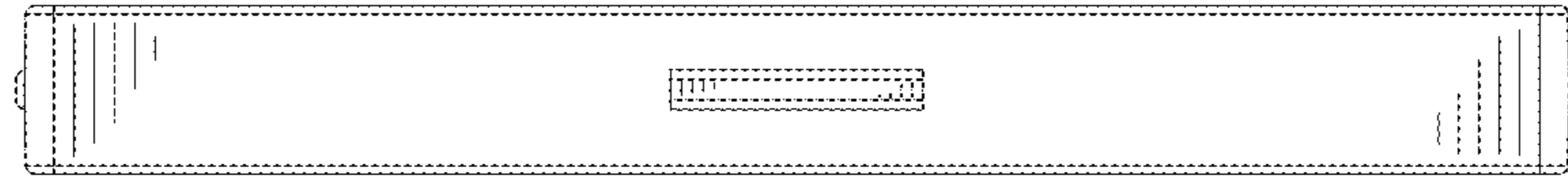

FIG. 54

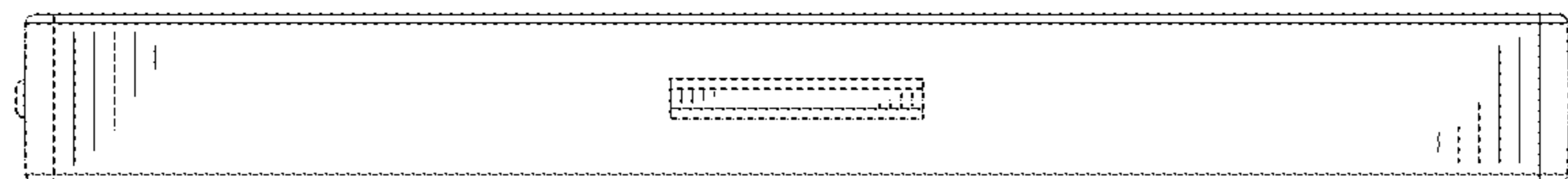

FIG. 55

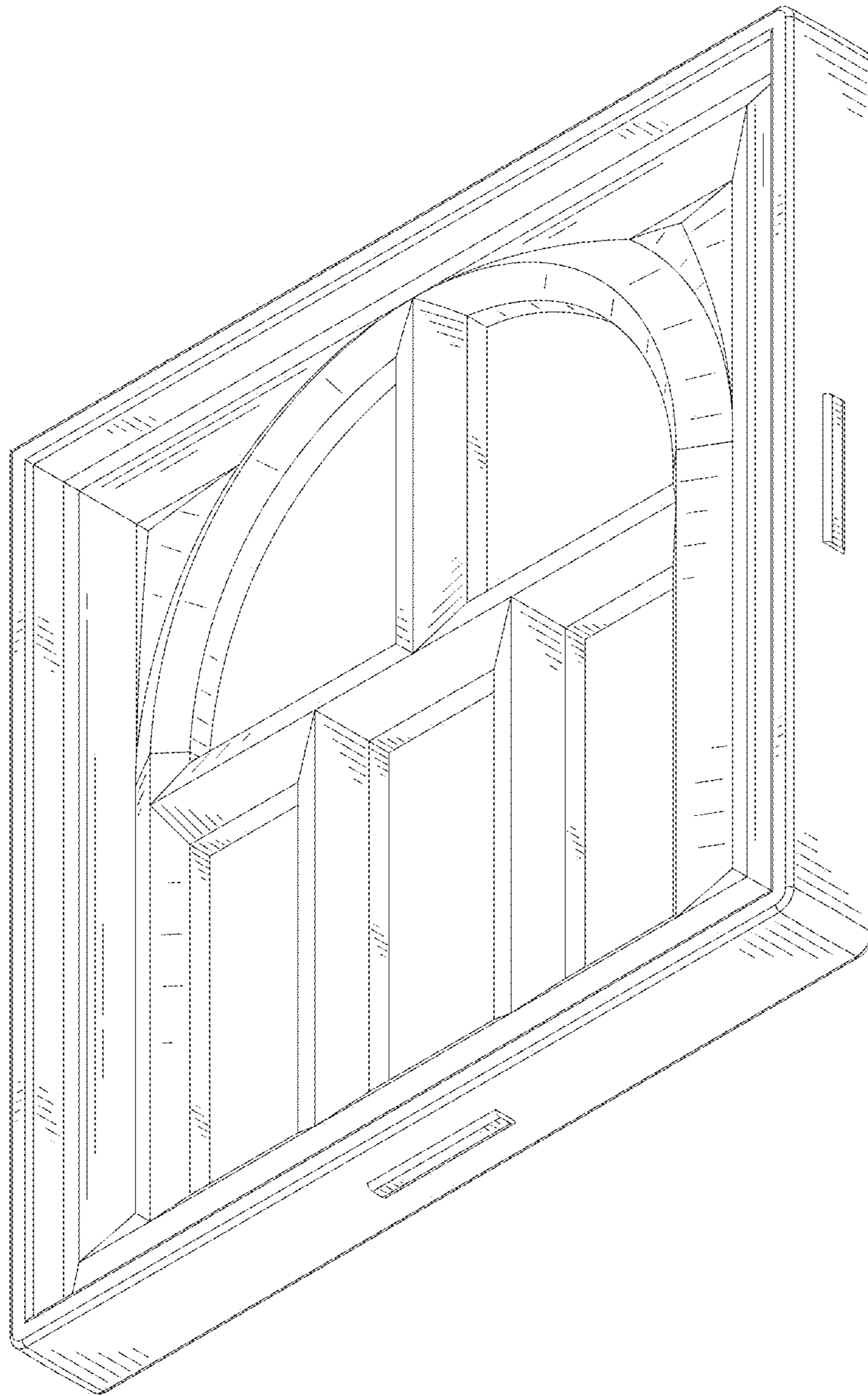

FIG. 56

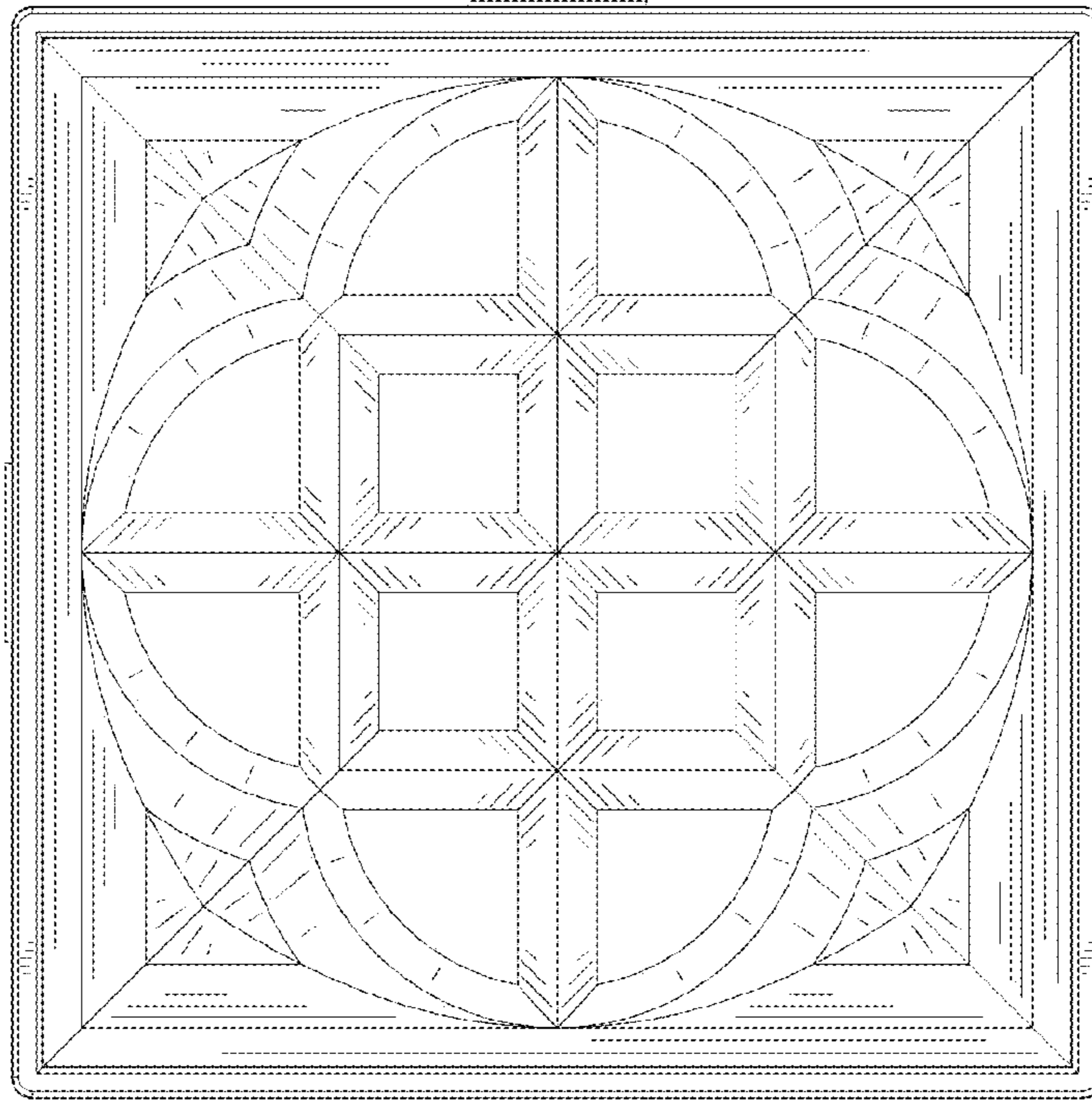

FIG. 57

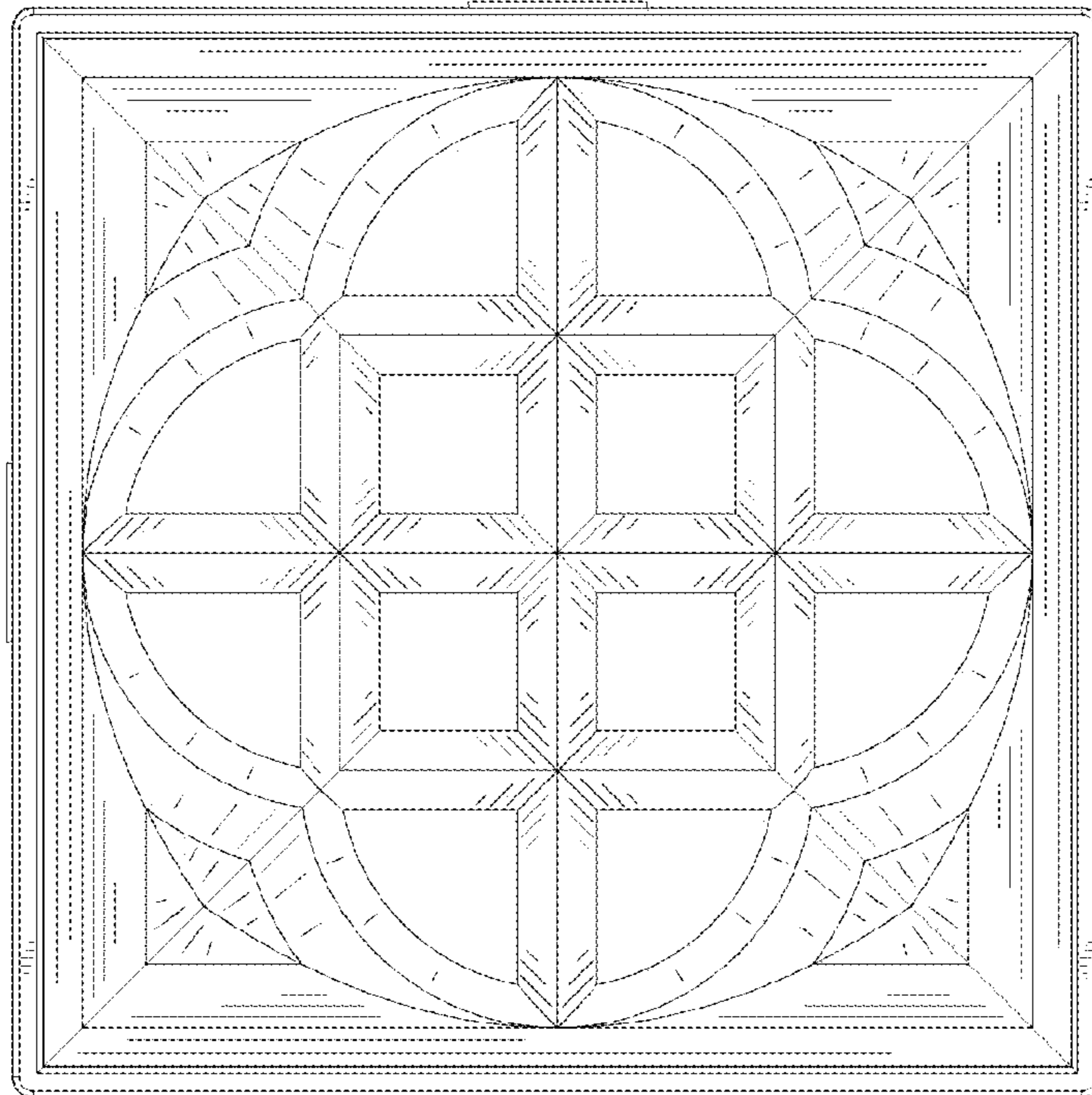

FIG. 58

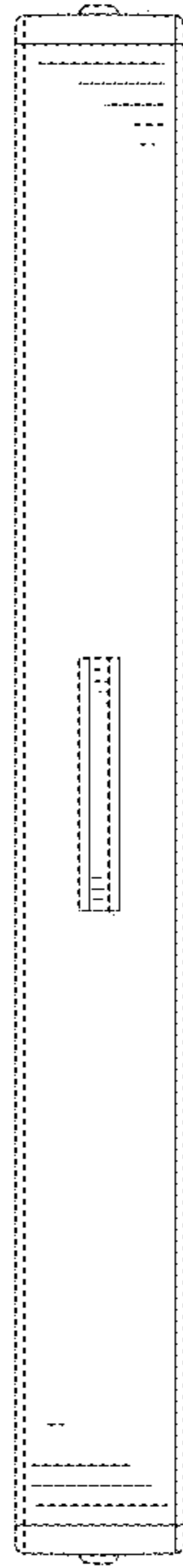

FIG. 59

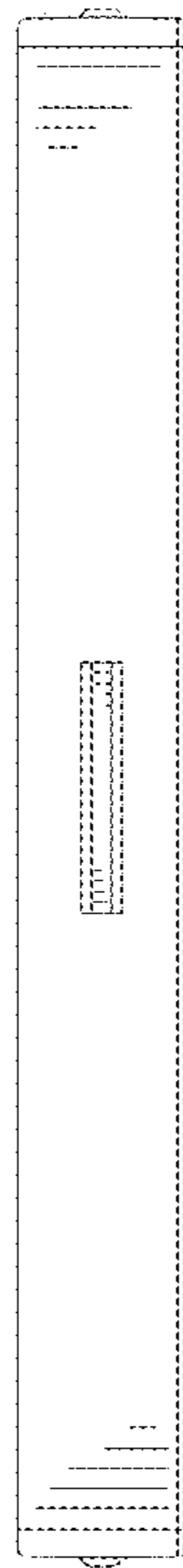

FIG. 60

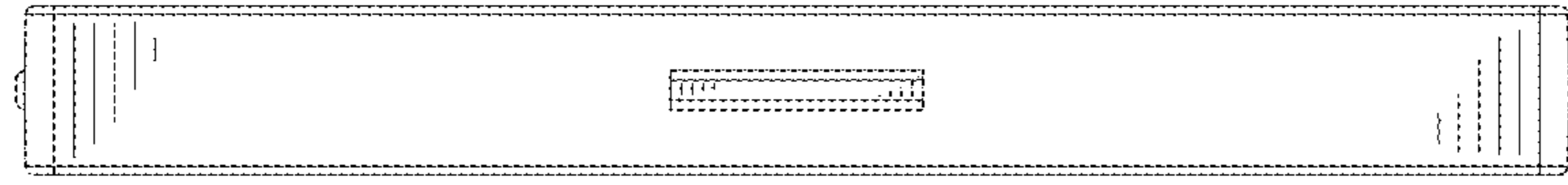

FIG. 61

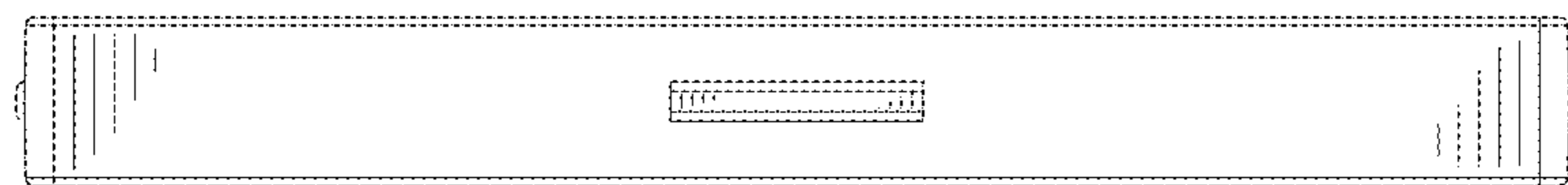

FIG. 62

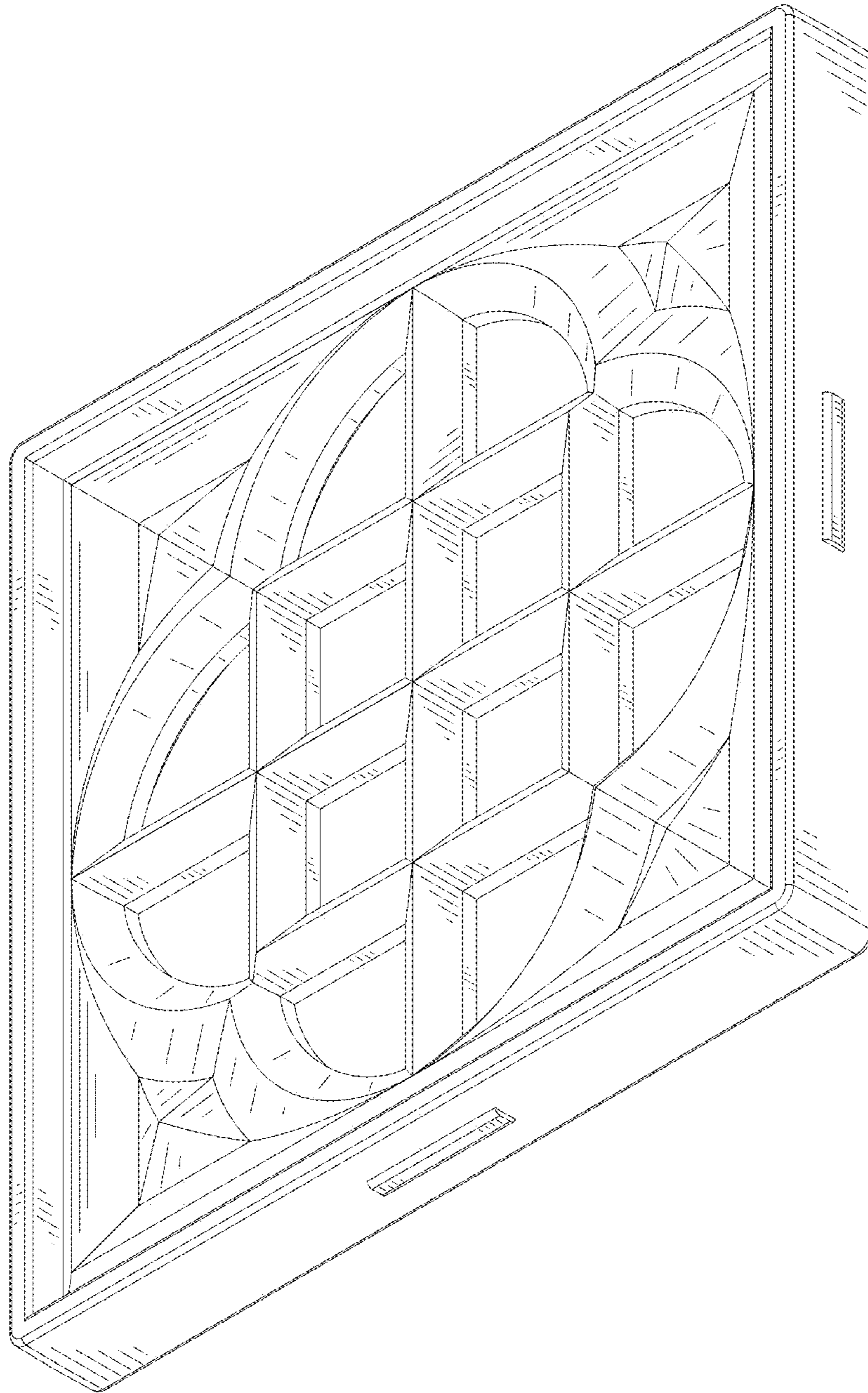

FIG. 63

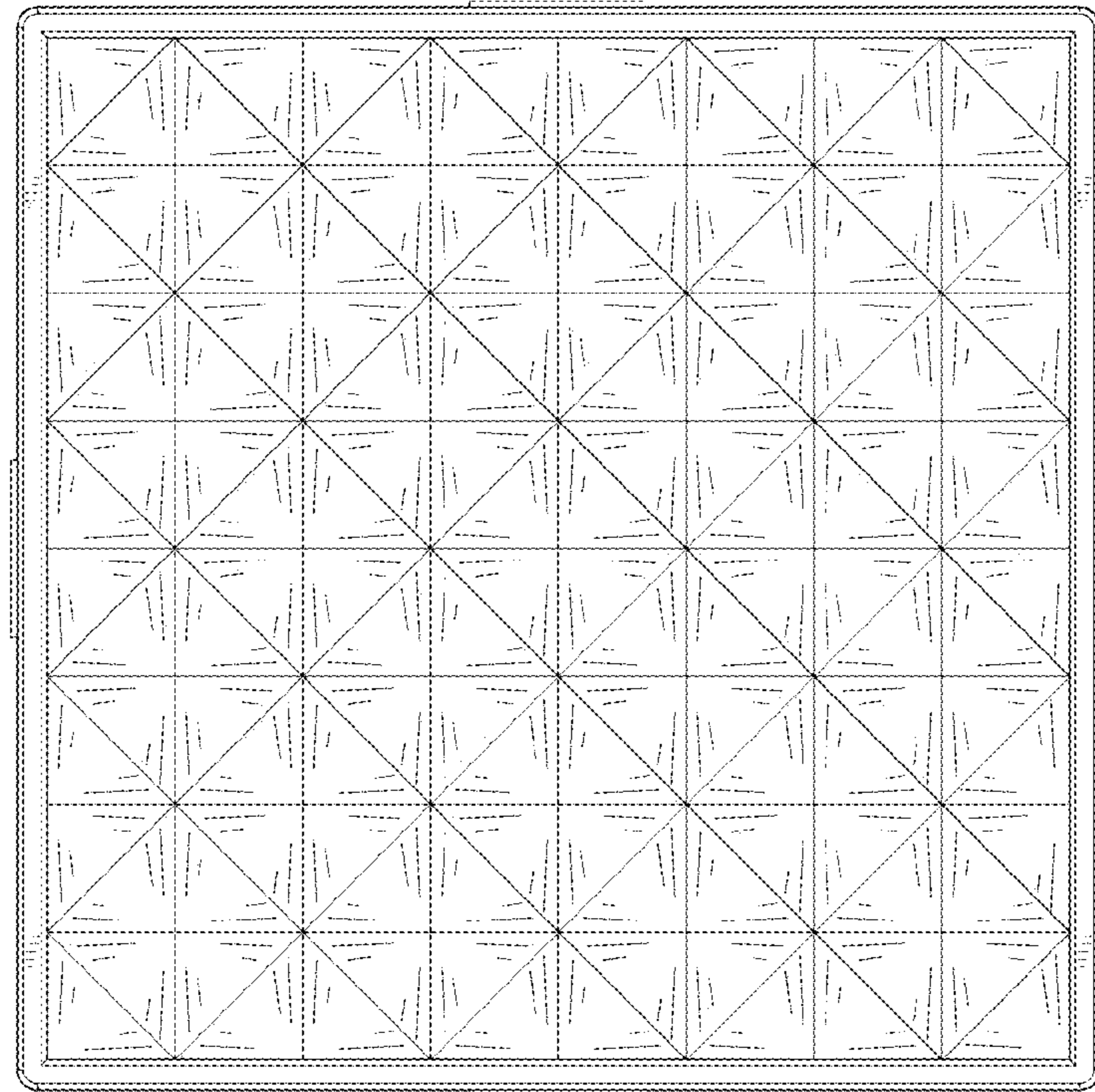

FIG. 64

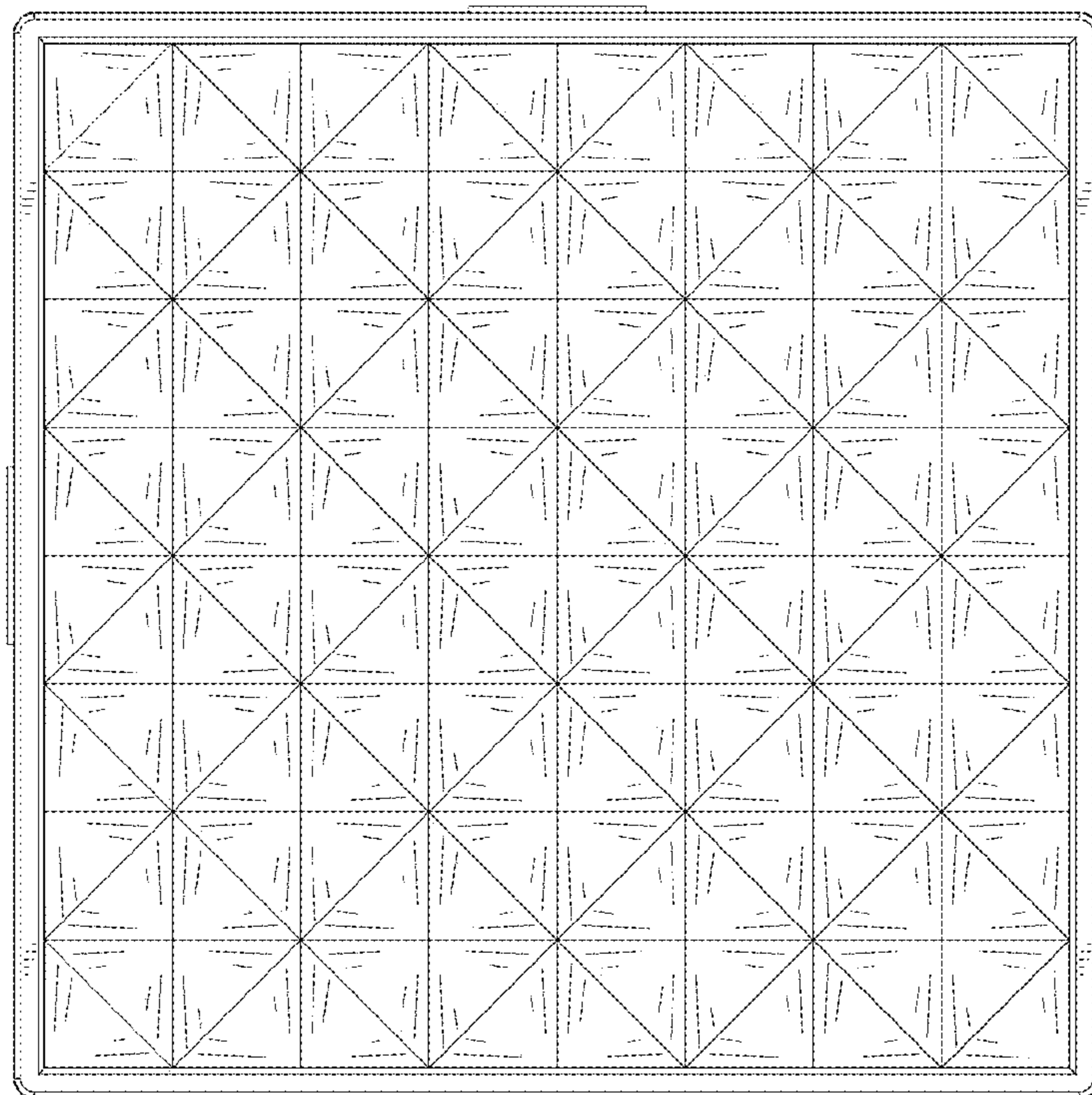

FIG. 65



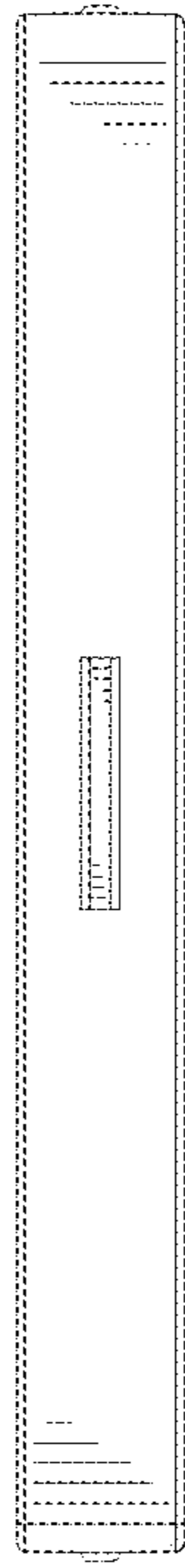

FIG. 66

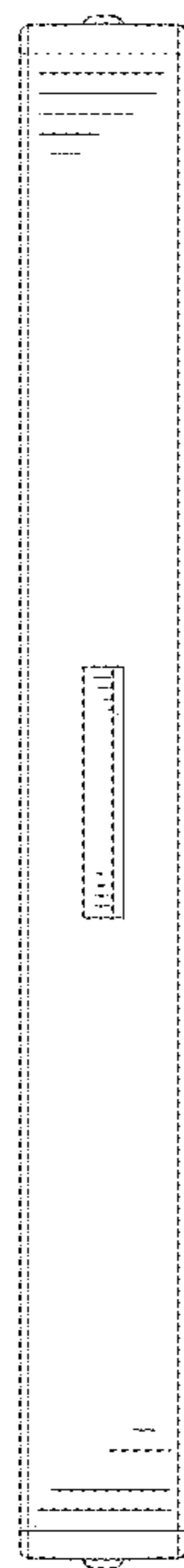

FIG. 67

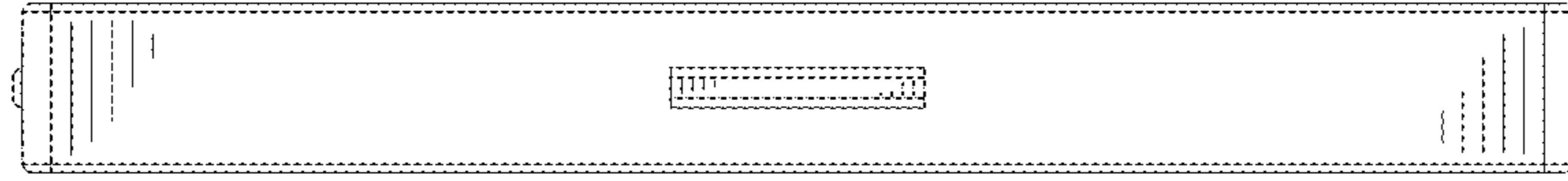

FIG. 68

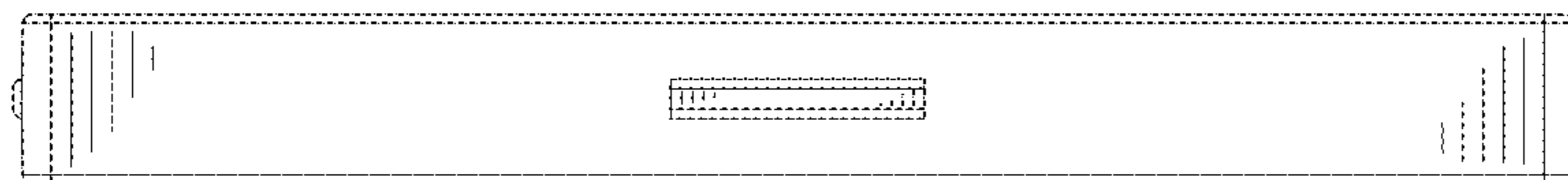

FIG. 69

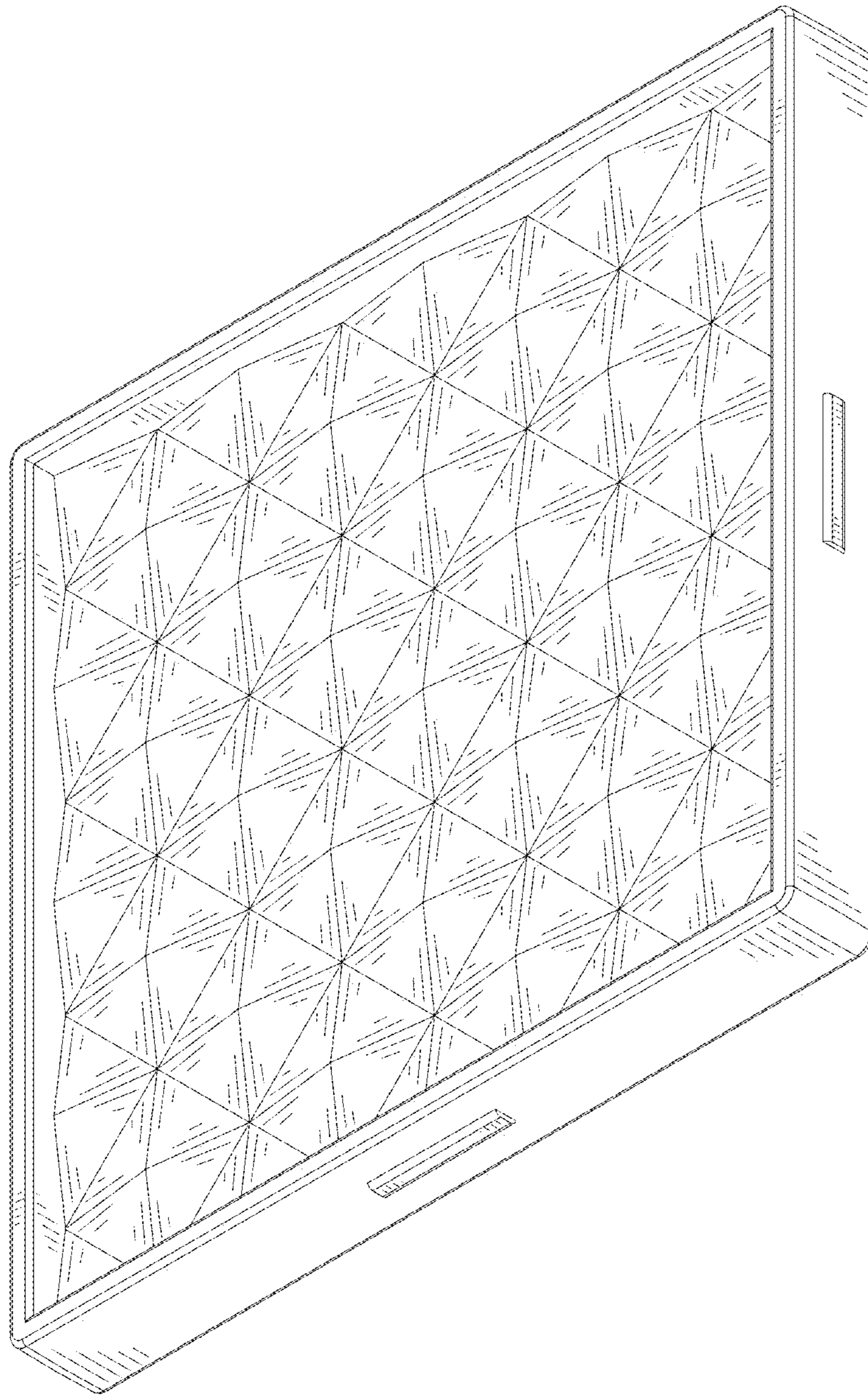

FIG. 70

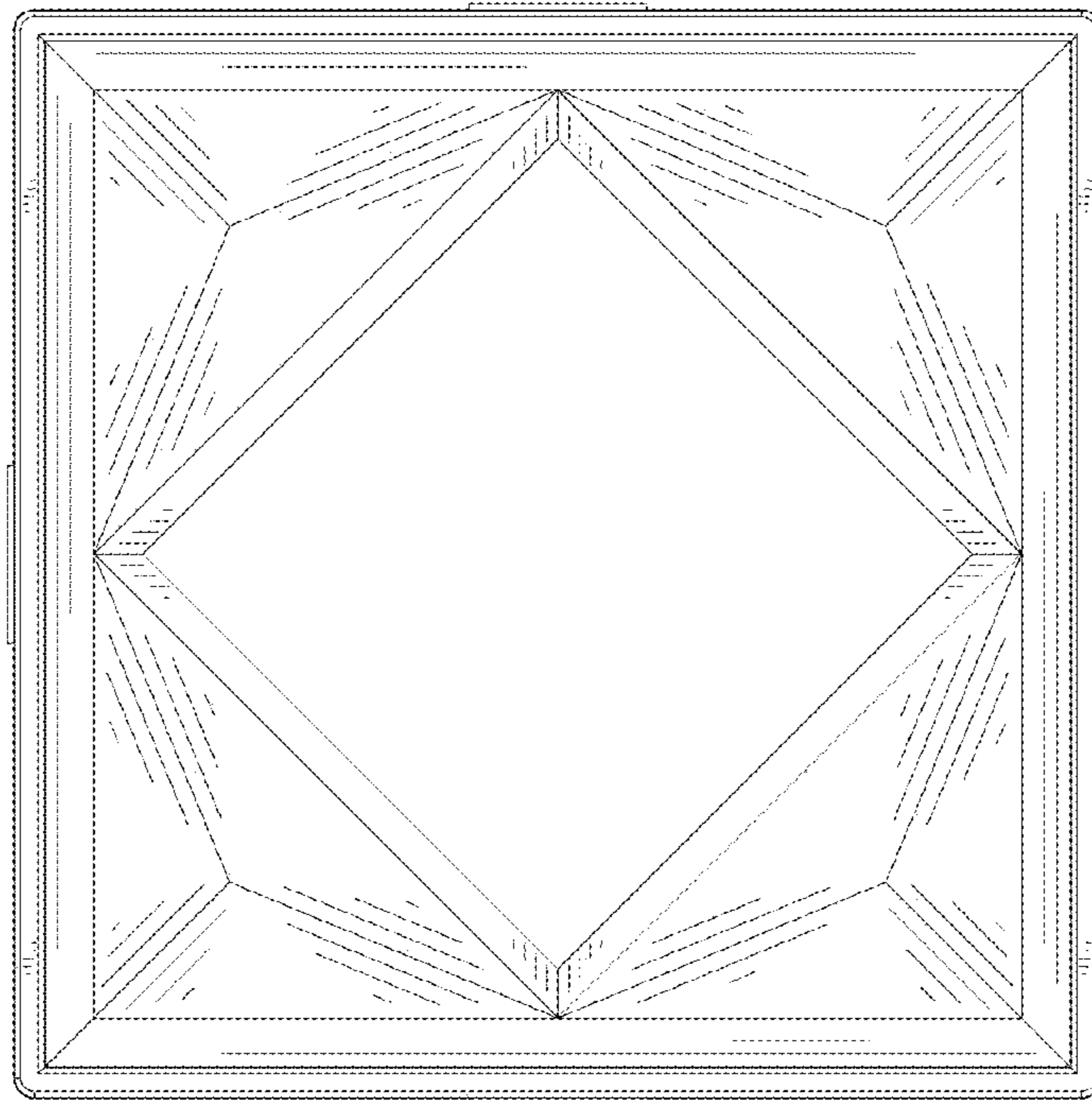

FIG. 71

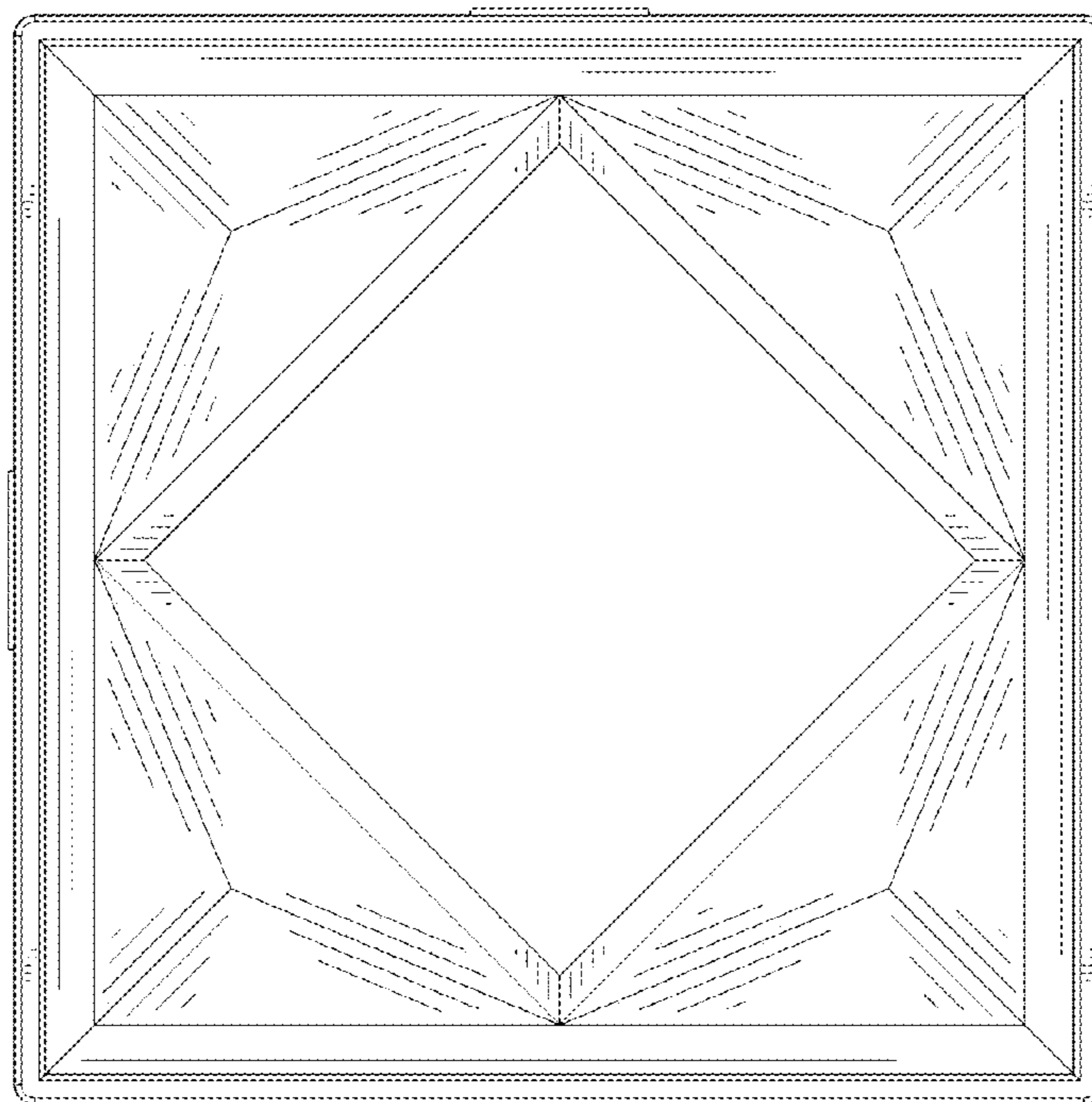

FIG. 72

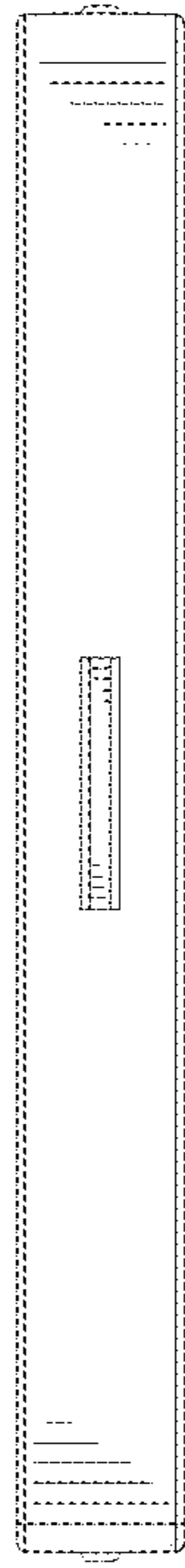

FIG. 73

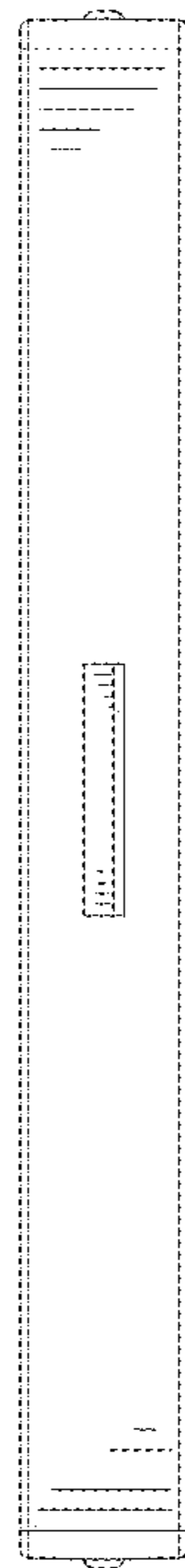

FIG. 74

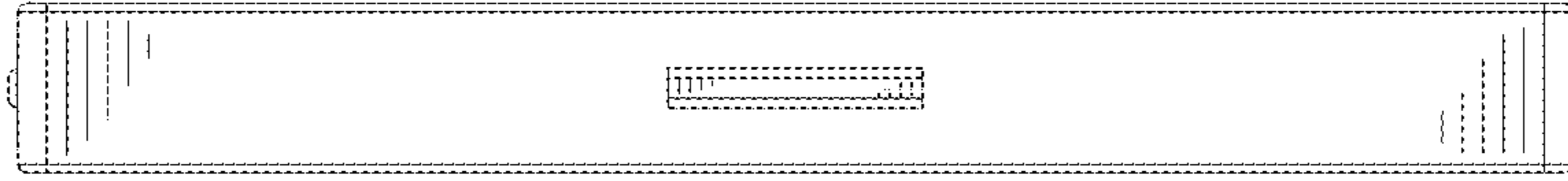

FIG. 75

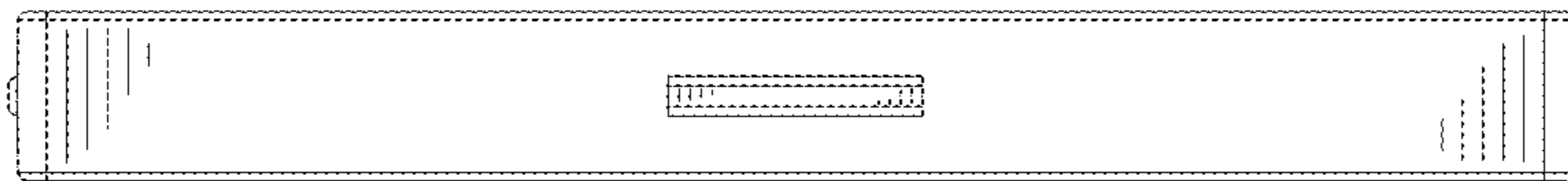

FIG. 76

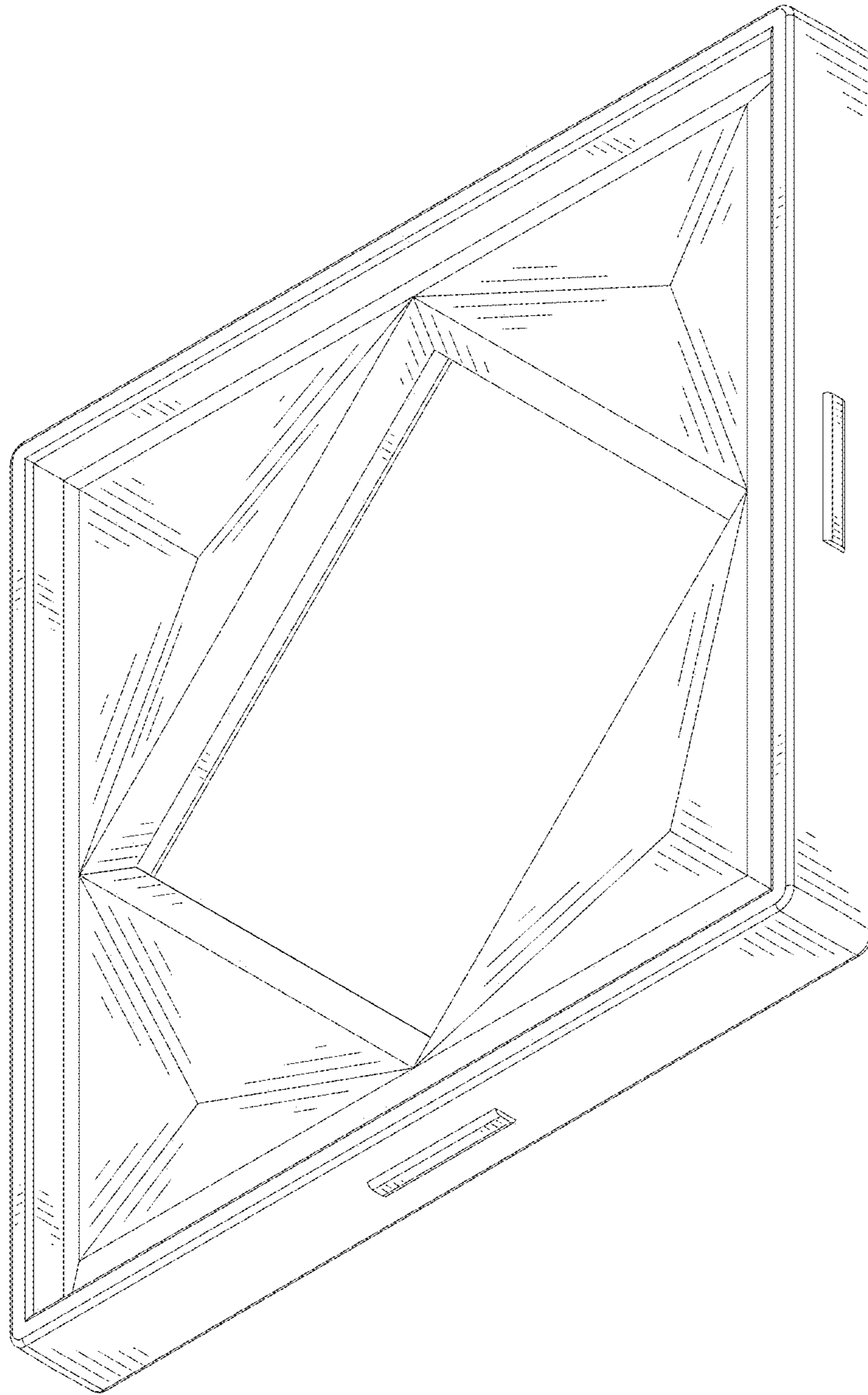

FIG. 77

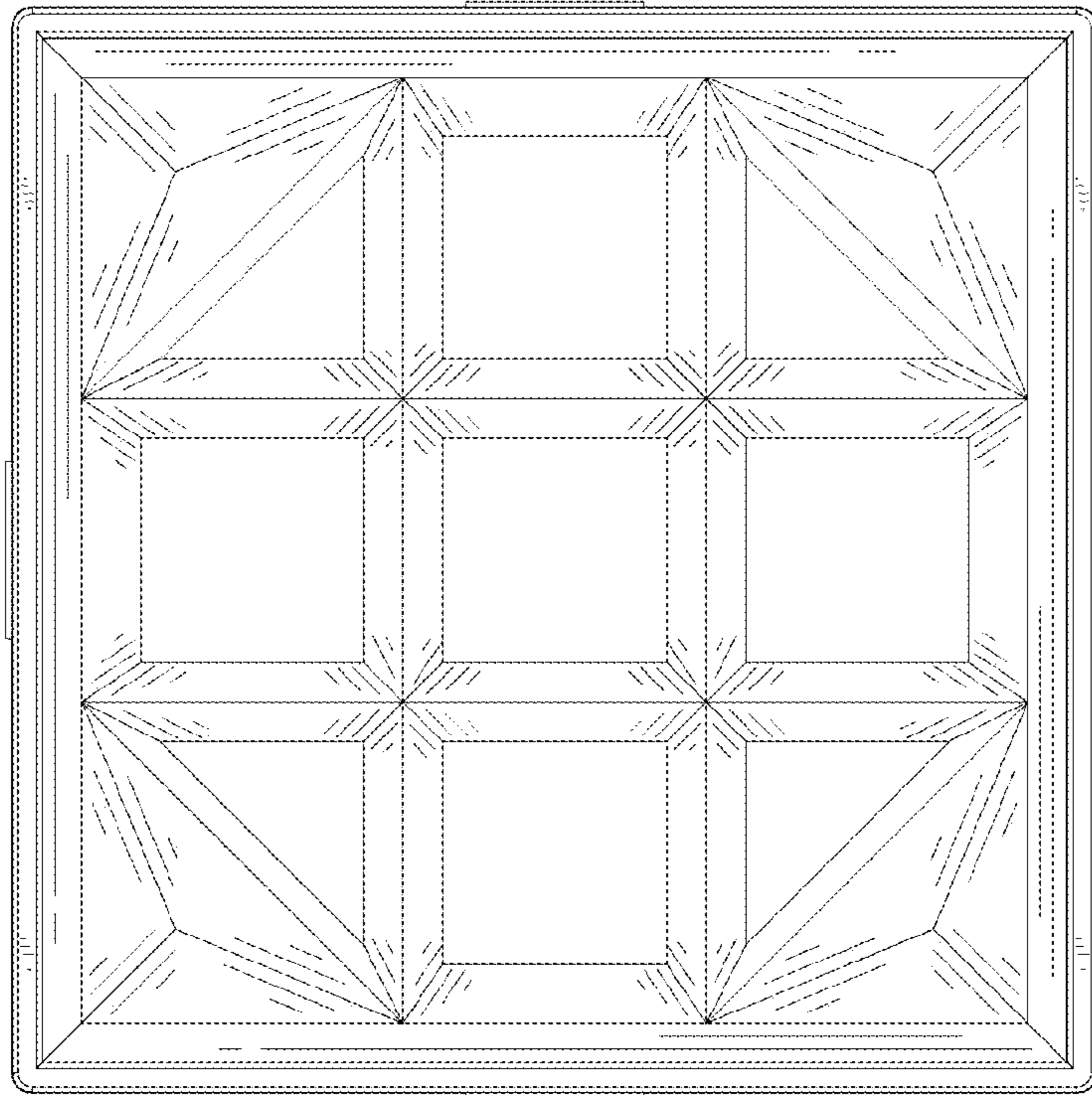

FIG. 78

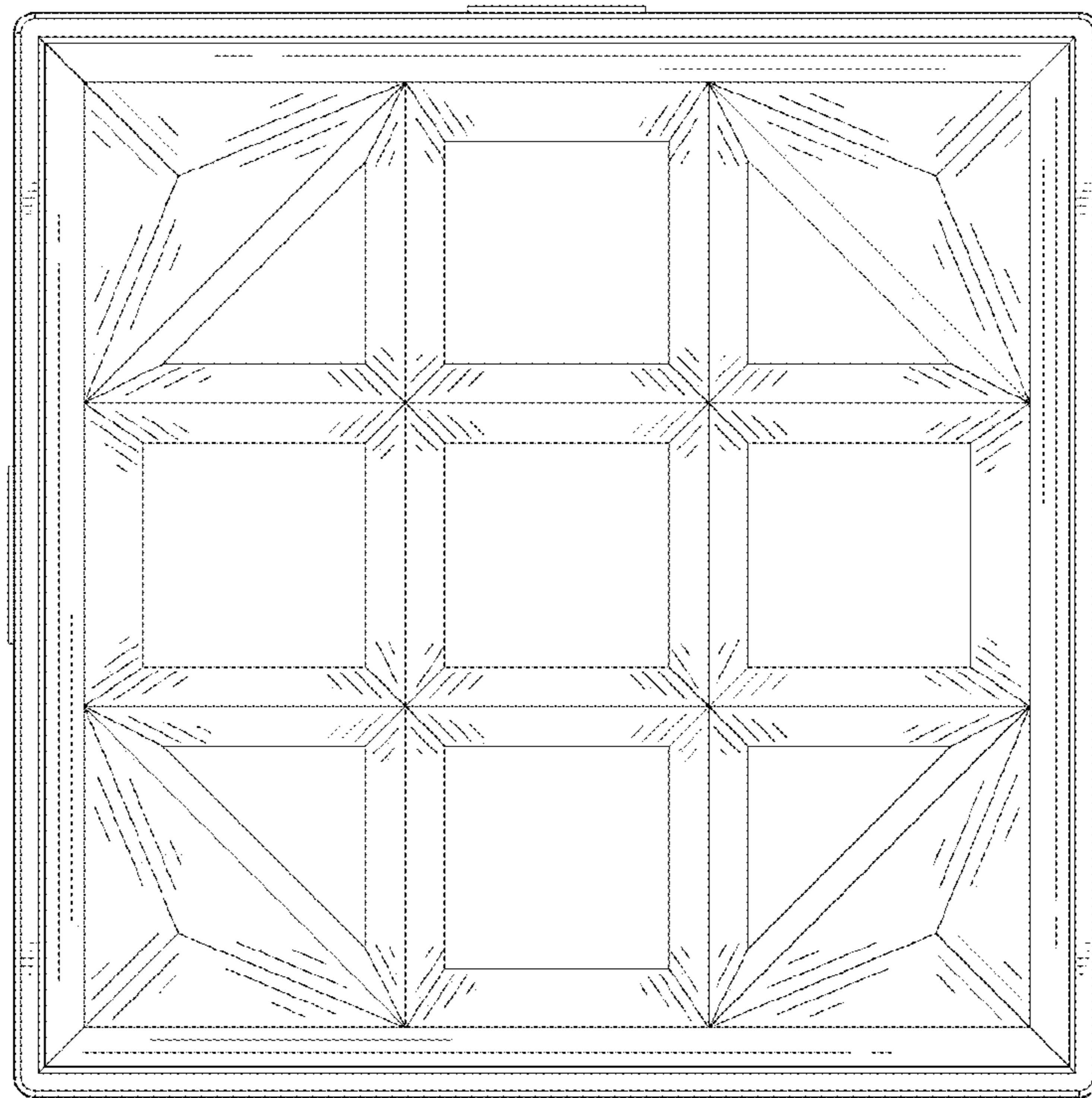

FIG. 79



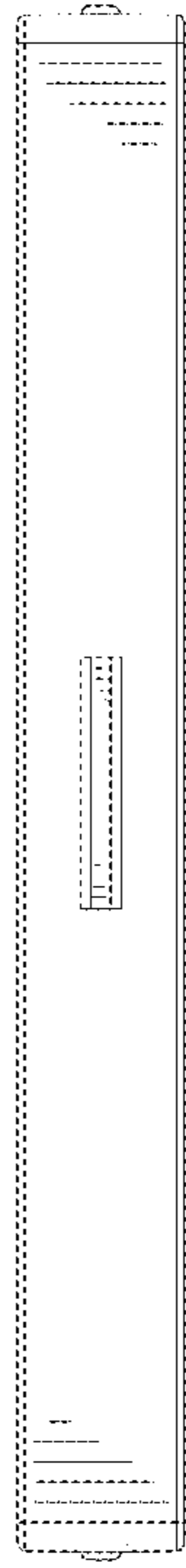

FIG. 80

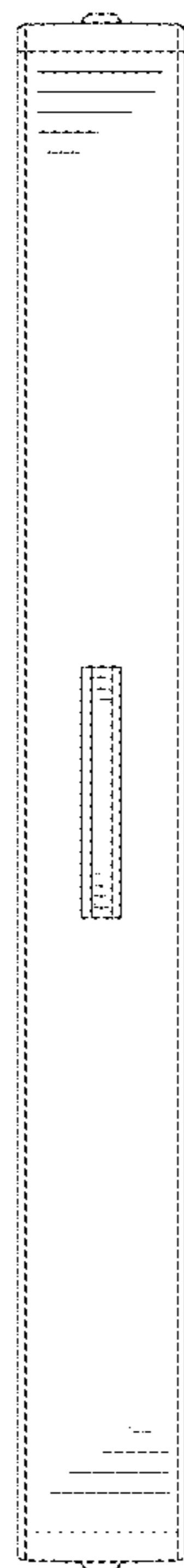

FIG. 81

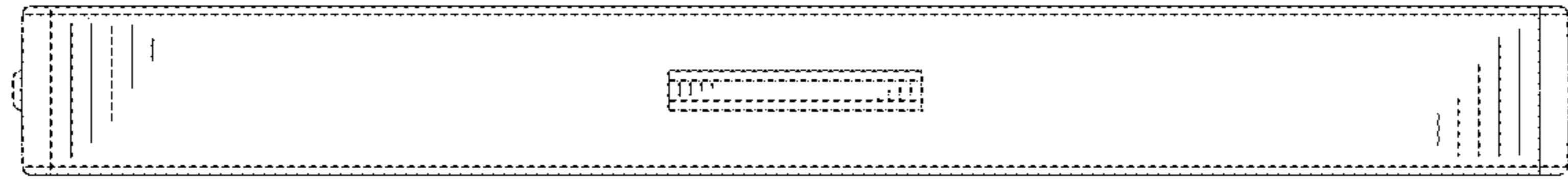

FIG. 82

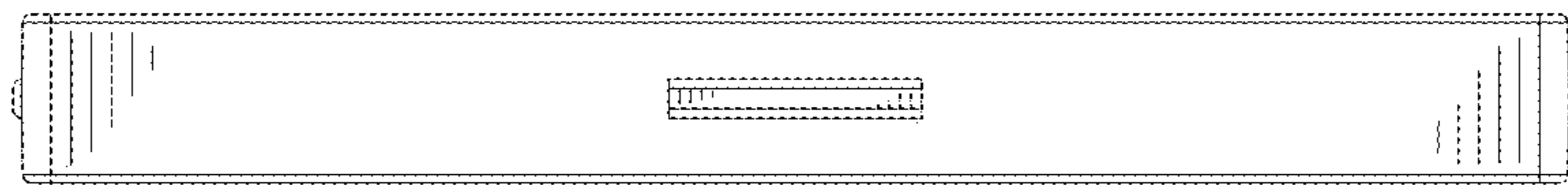

FIG. 83

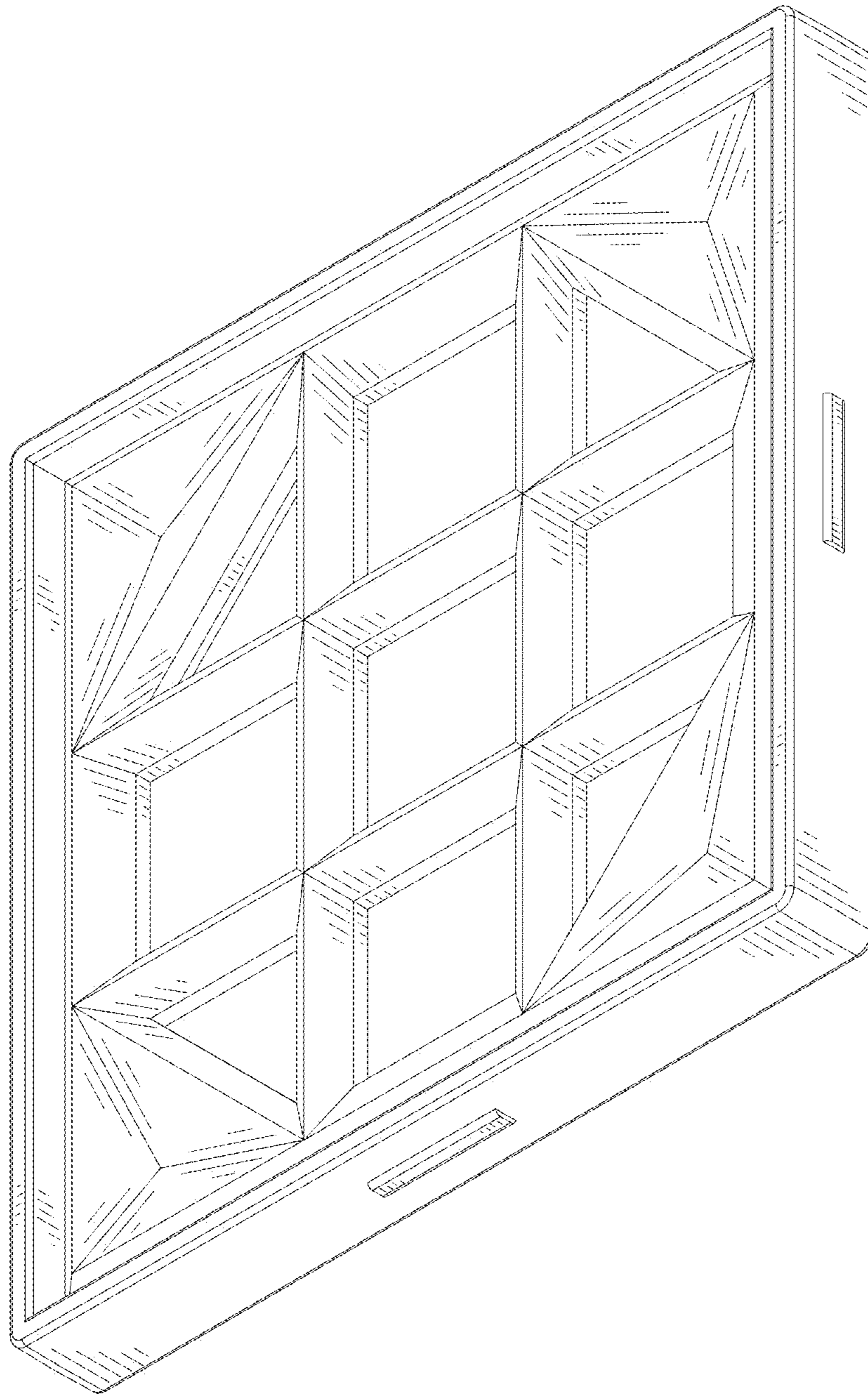

FIG. 84

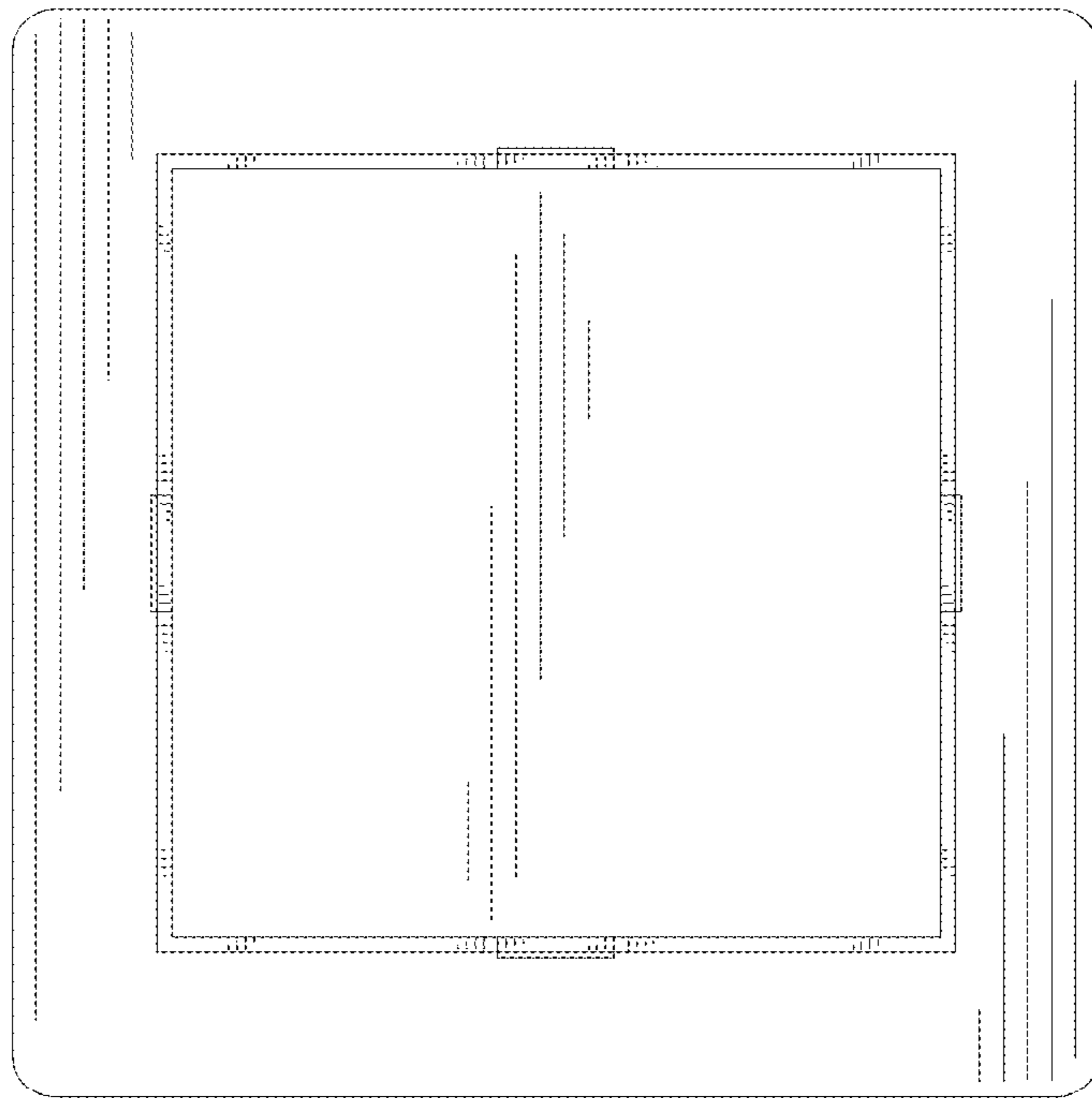

FIG. 85

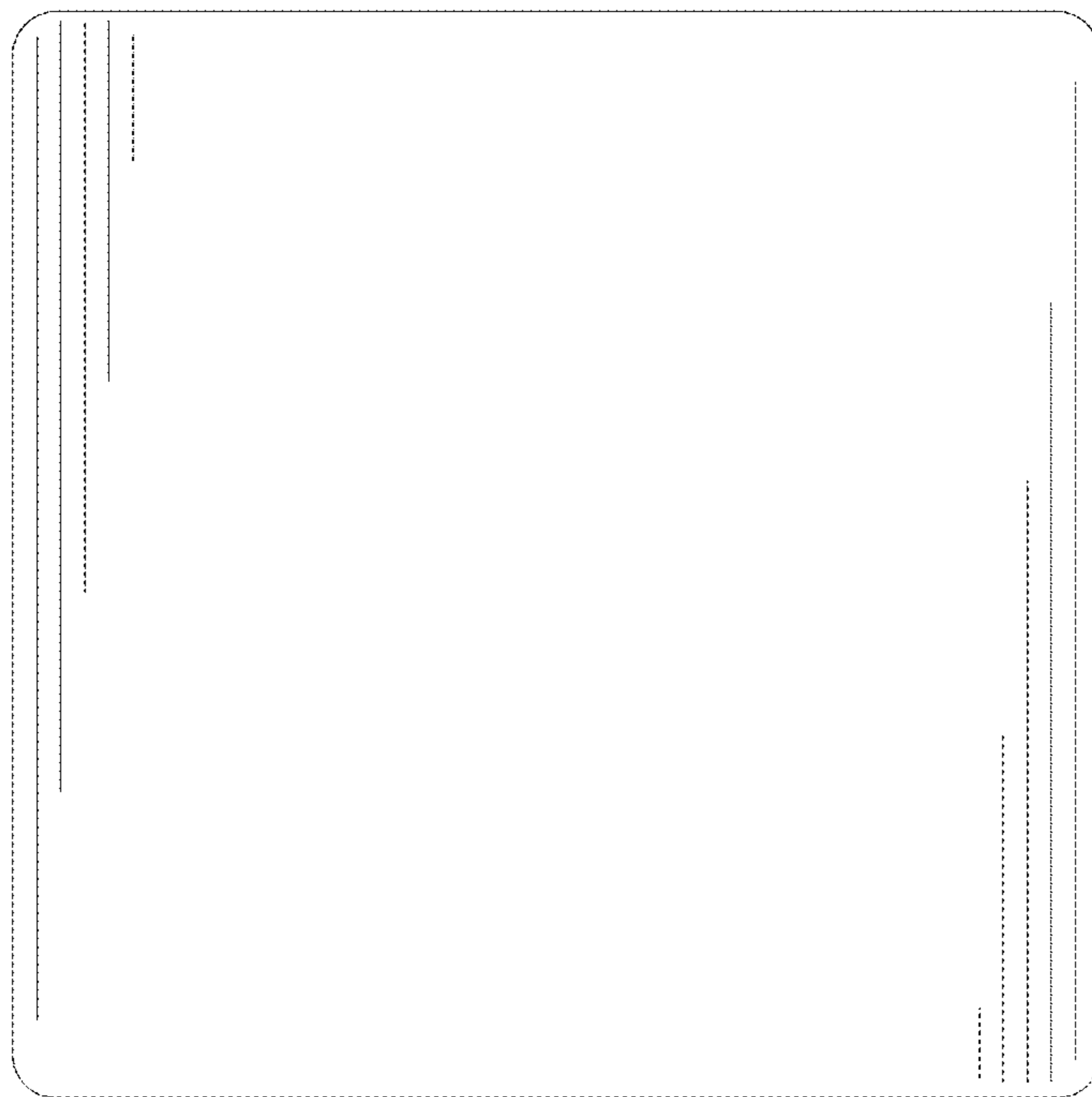

FIG. 86

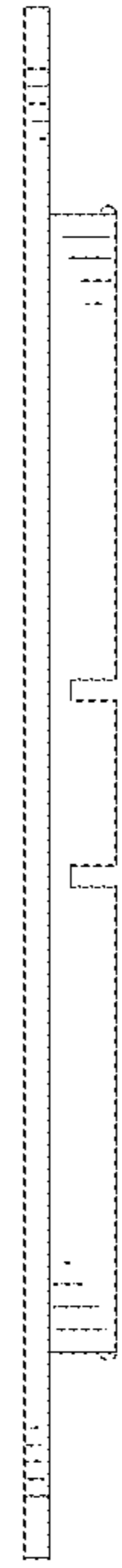

FIG. 87

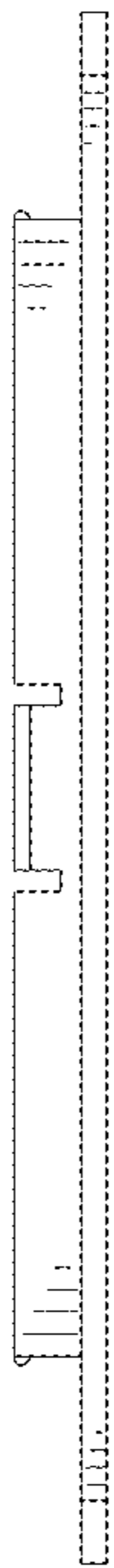

FIG. 88

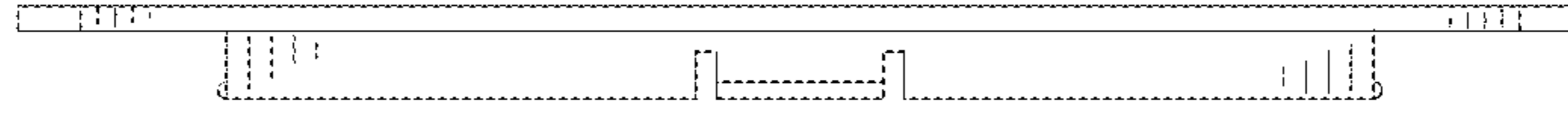

FIG. 89

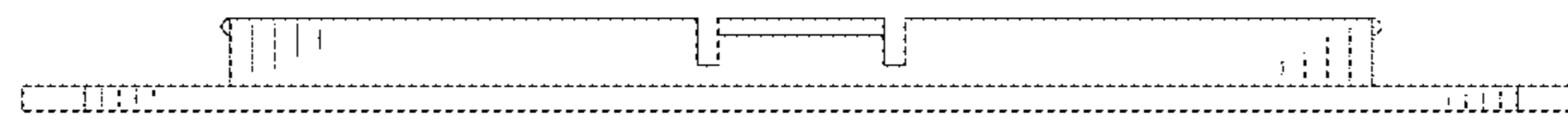

FIG. 90

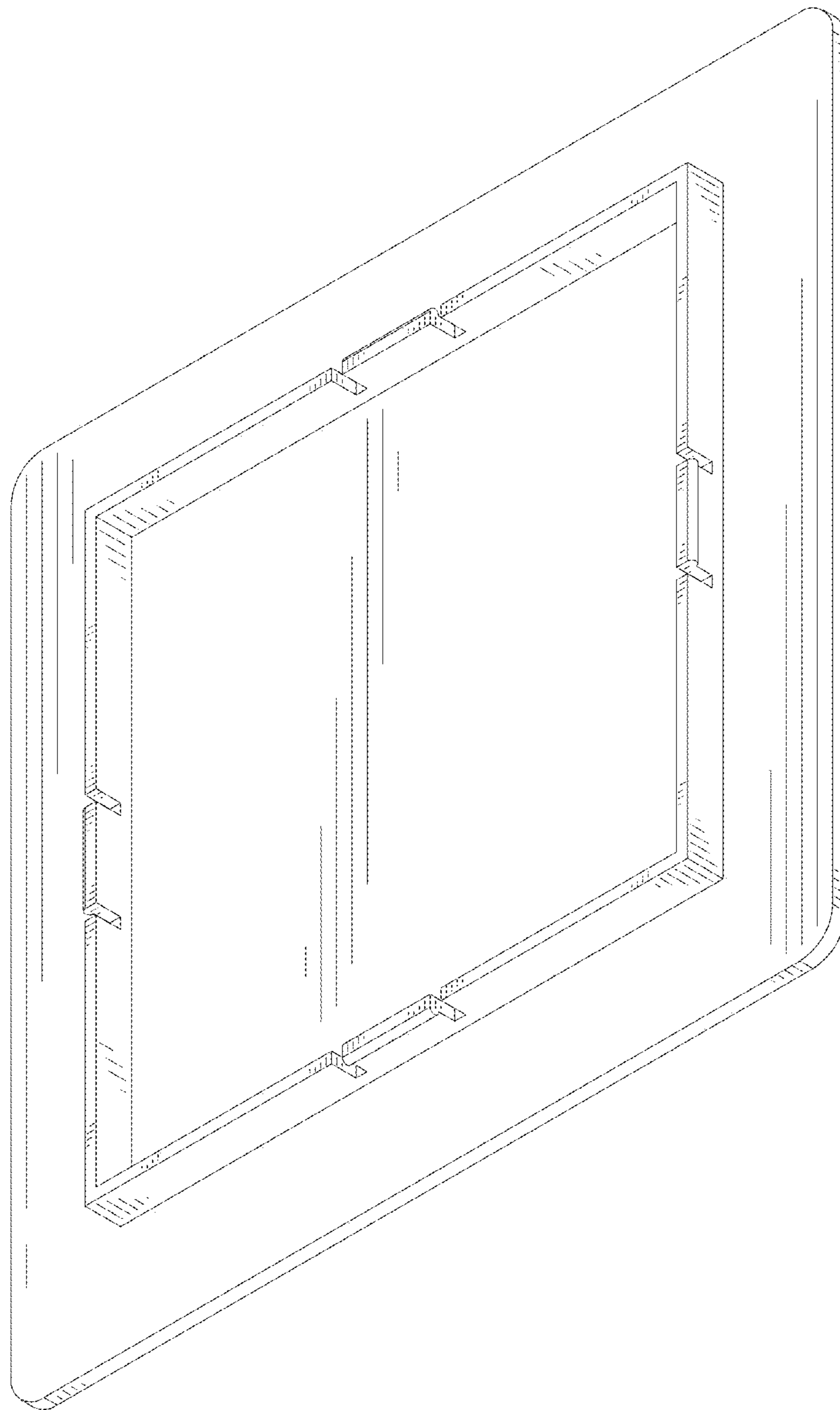

FIG. 91

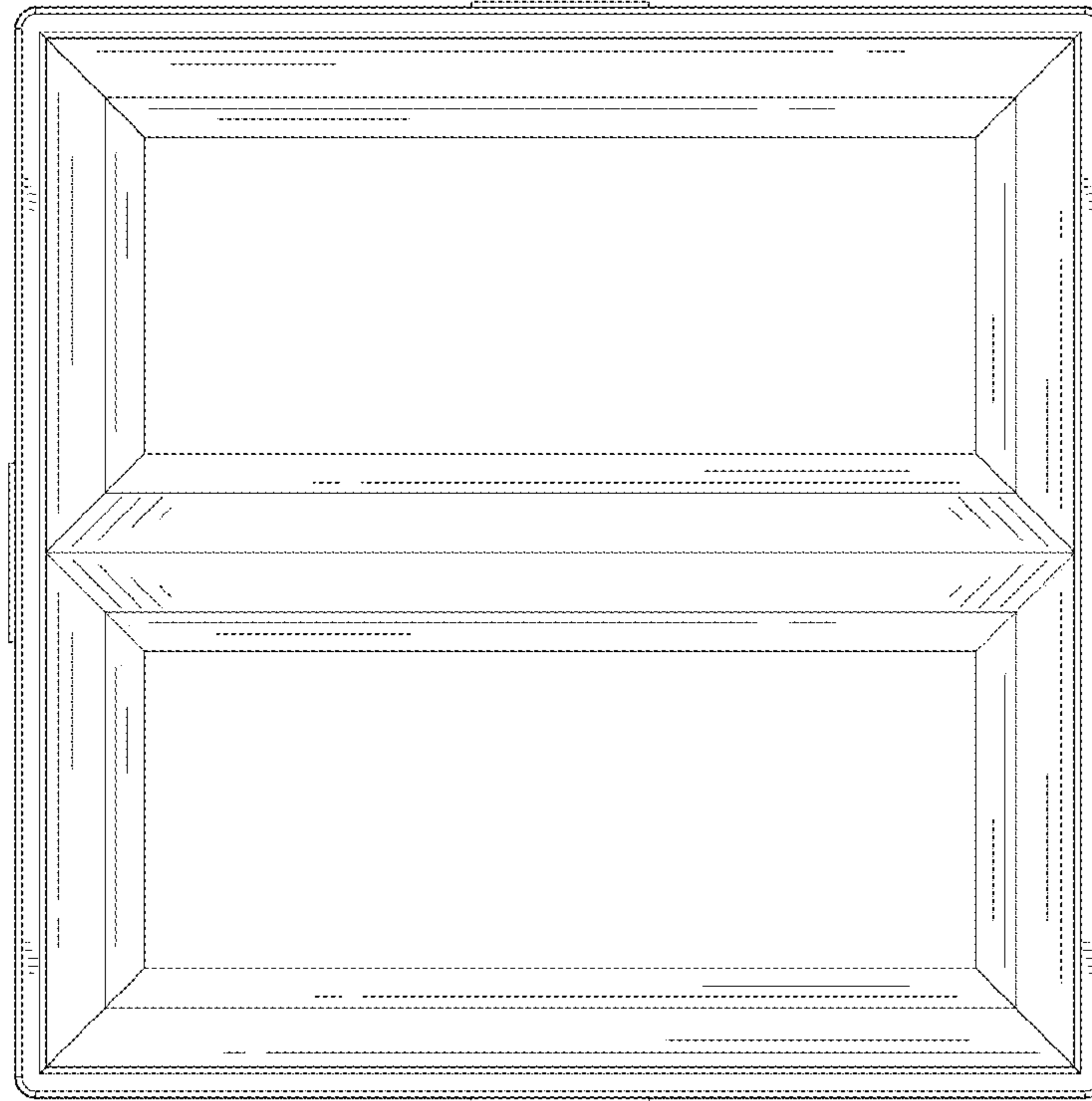

FIG. 92

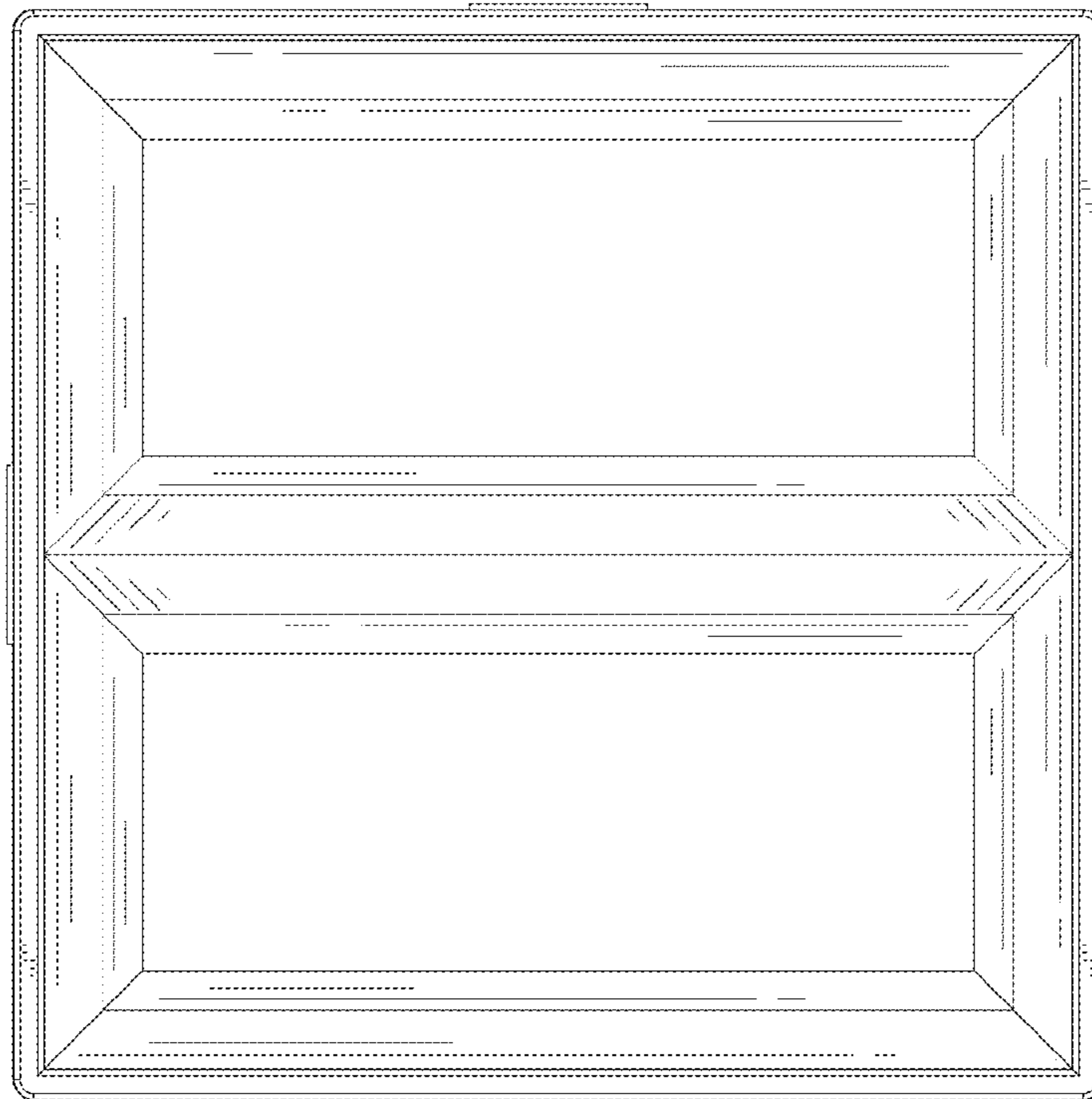

FIG. 93



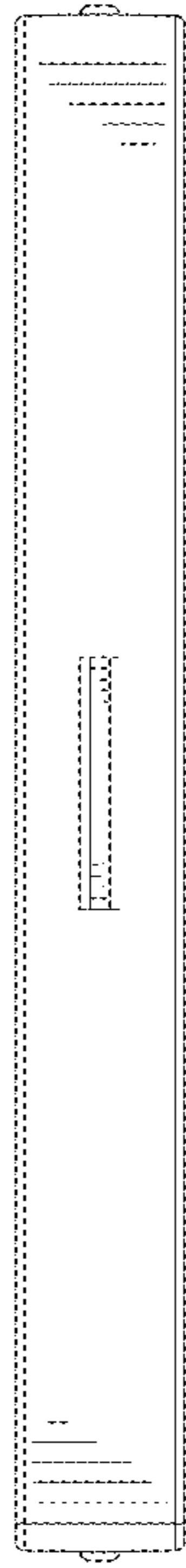

FIG. 94

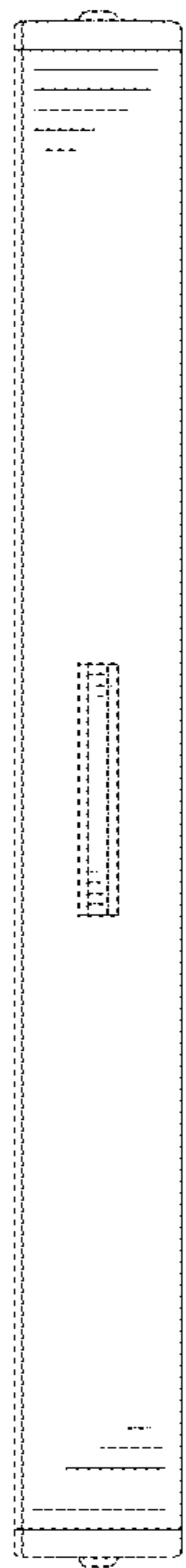

FIG. 95

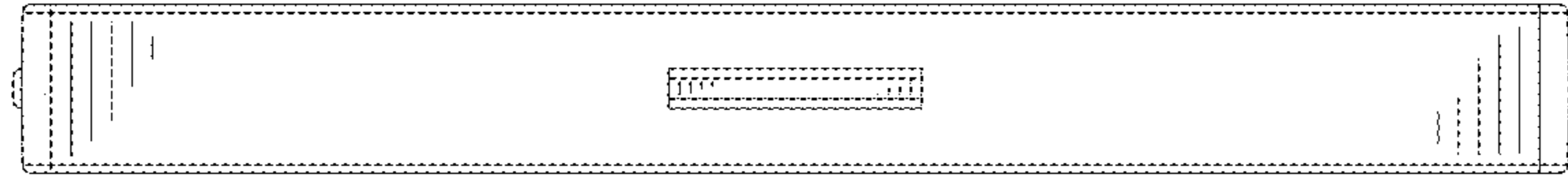

FIG. 96

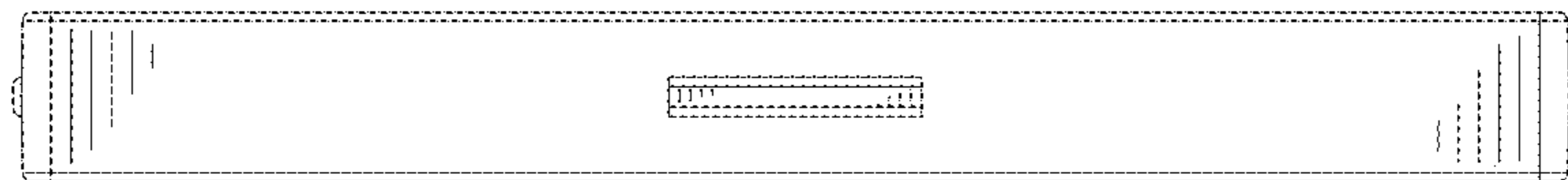

FIG. 97

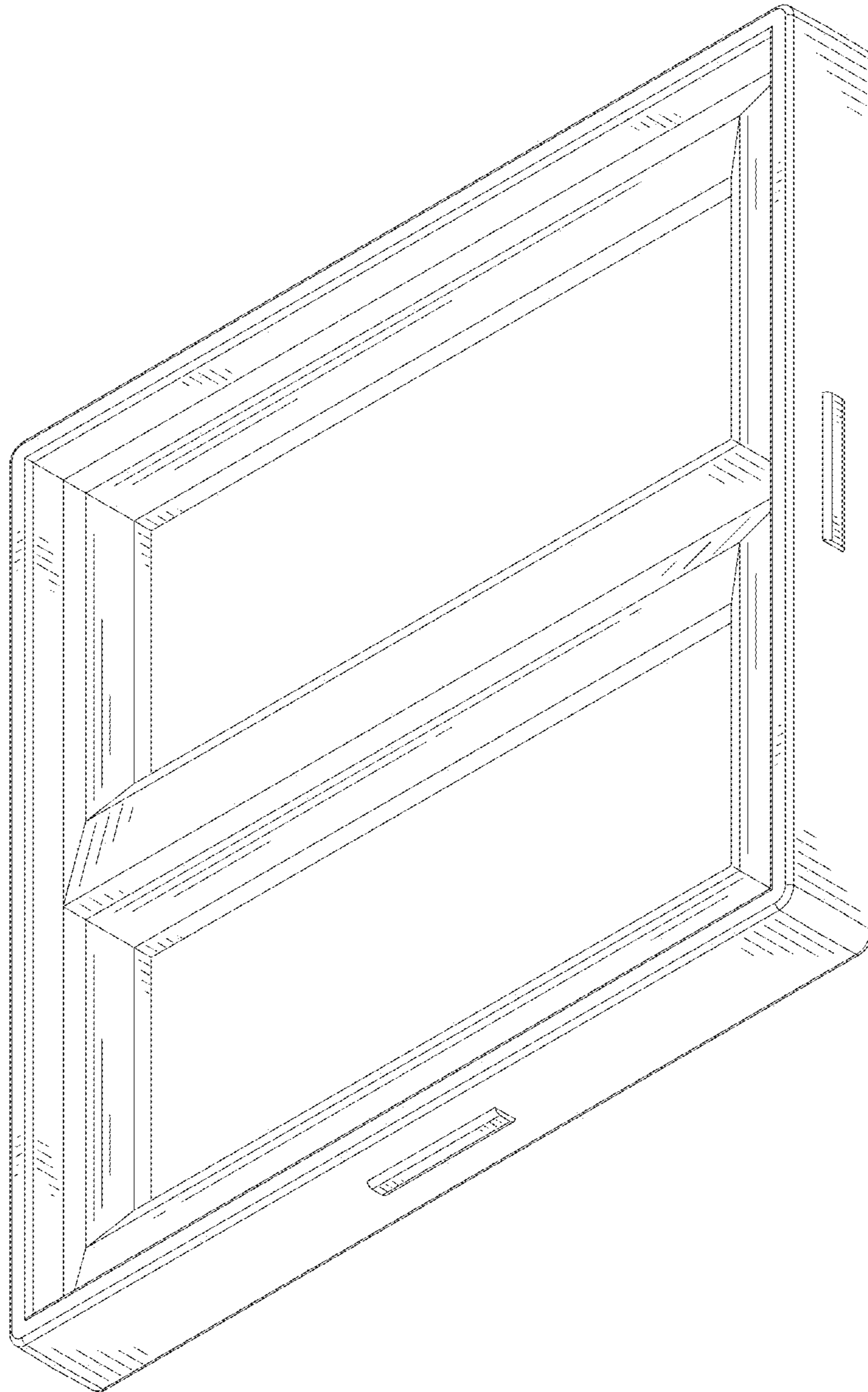

FIG. 98

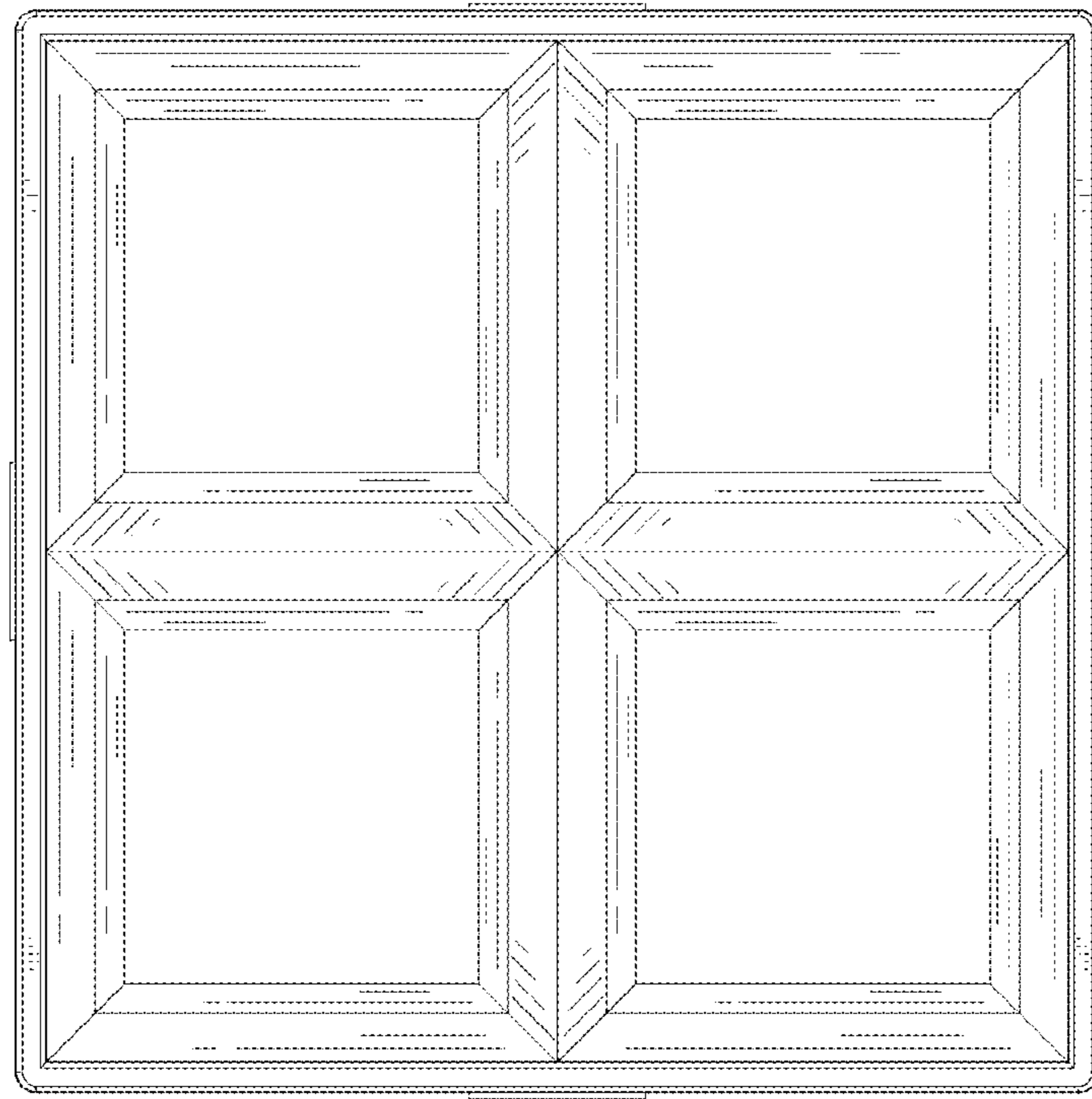

FIG. 99

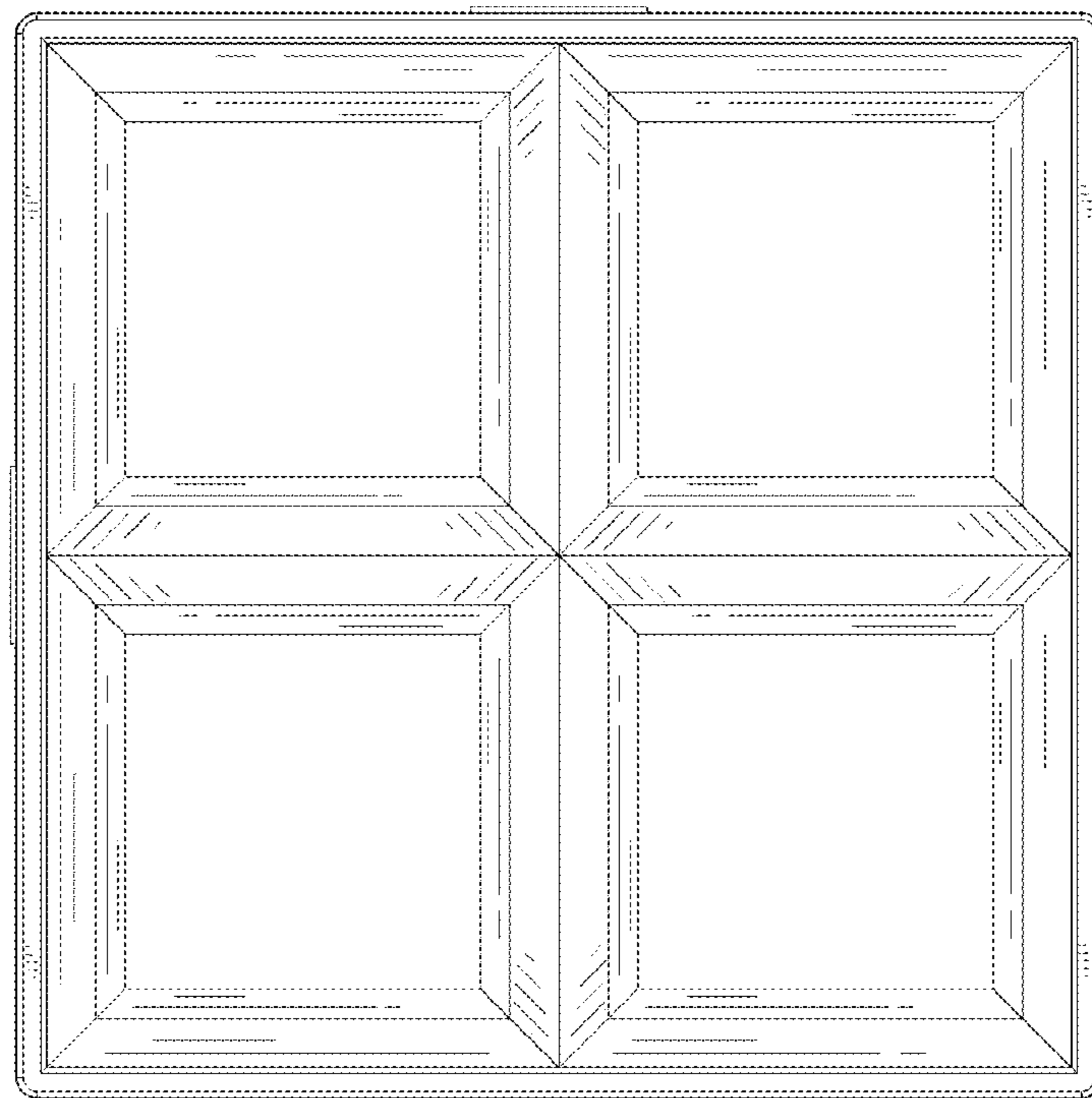

FIG. 100

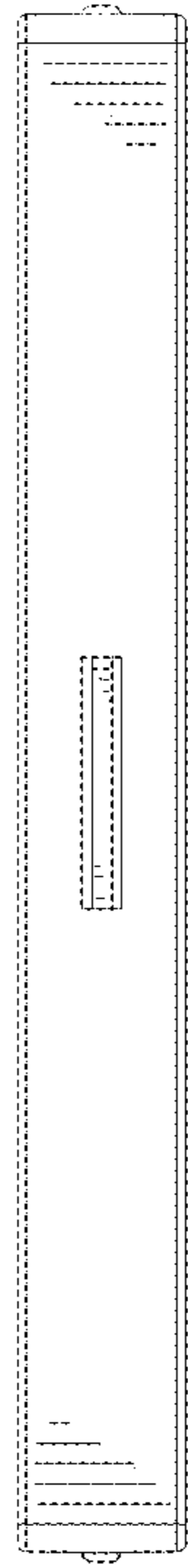

FIG. 101

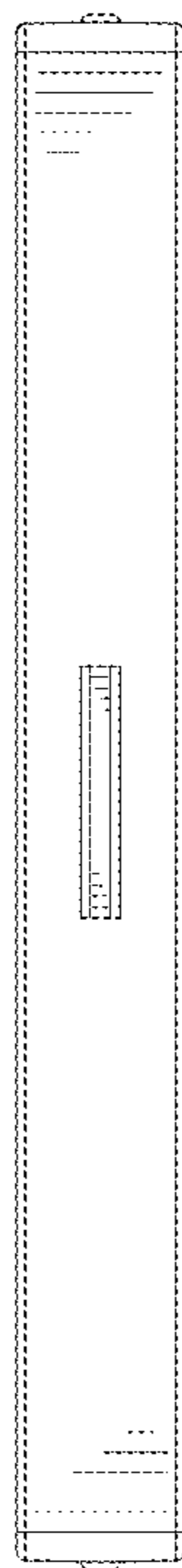

FIG. 102

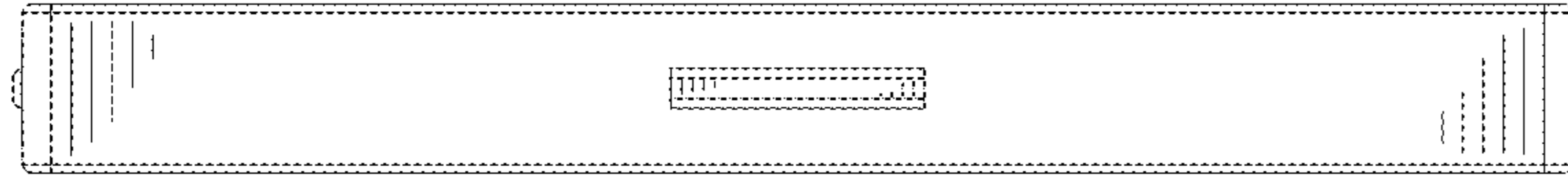

FIG. 103

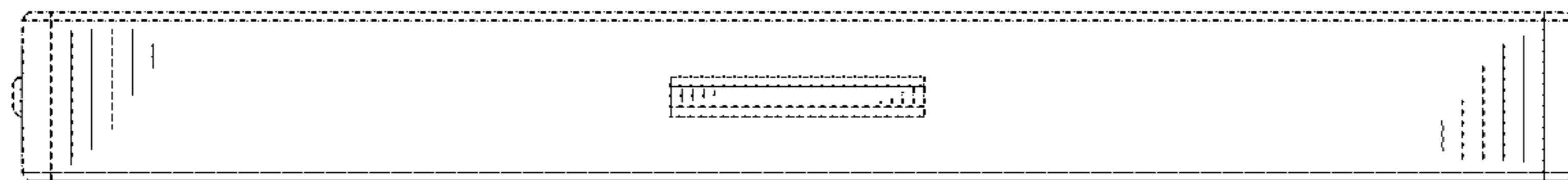

FIG. 104

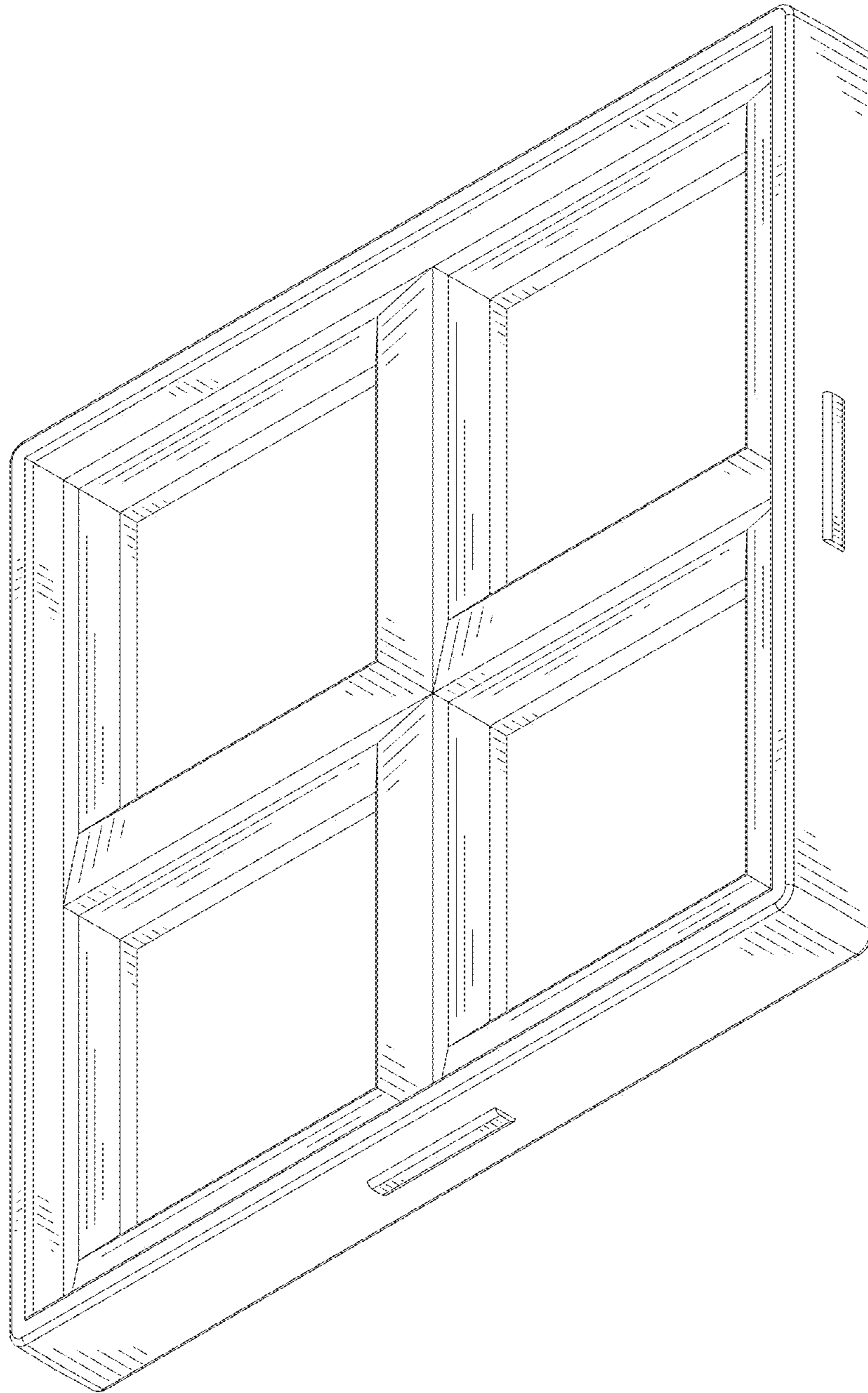

FIG. 105

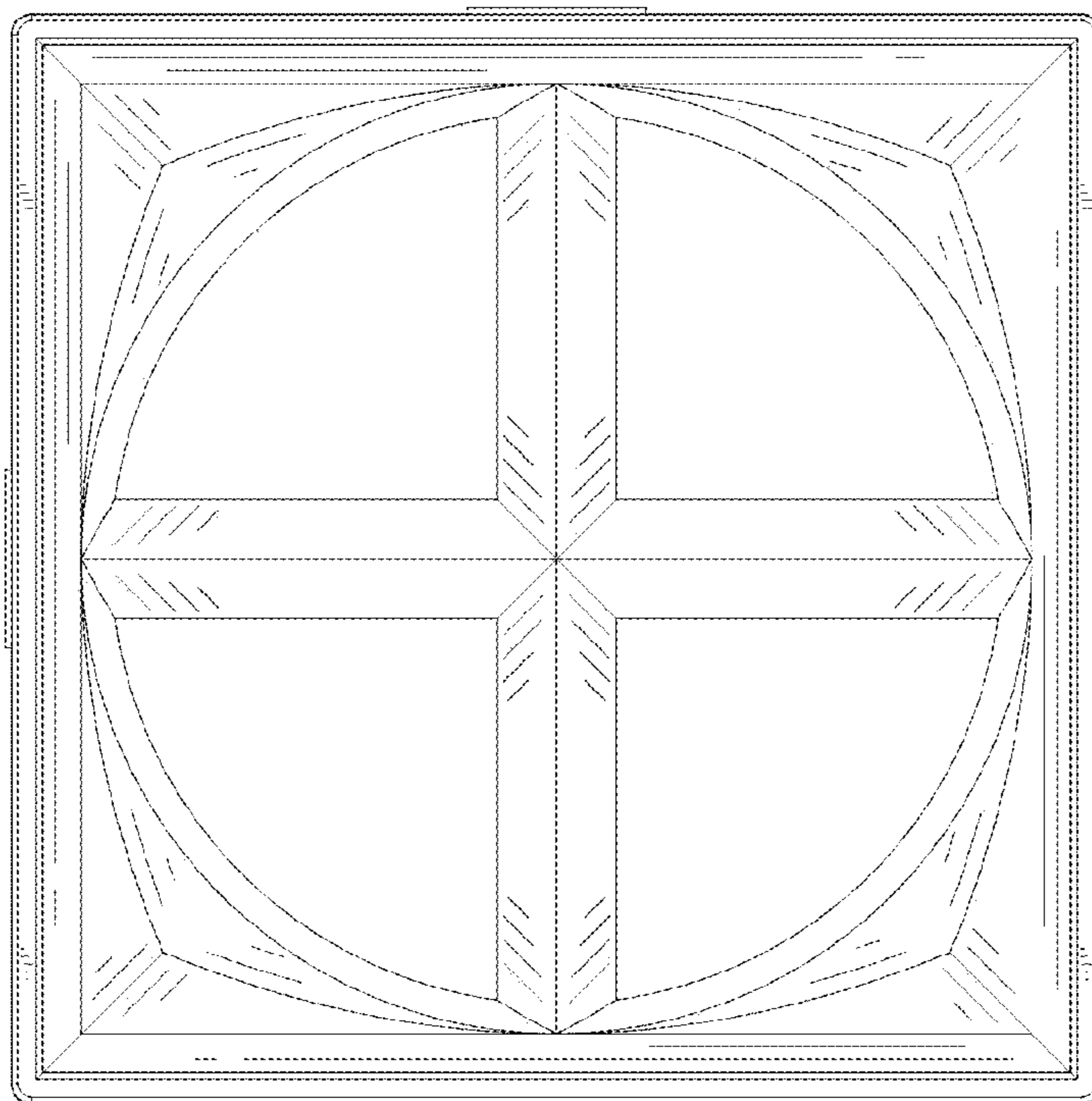

FIG. 106

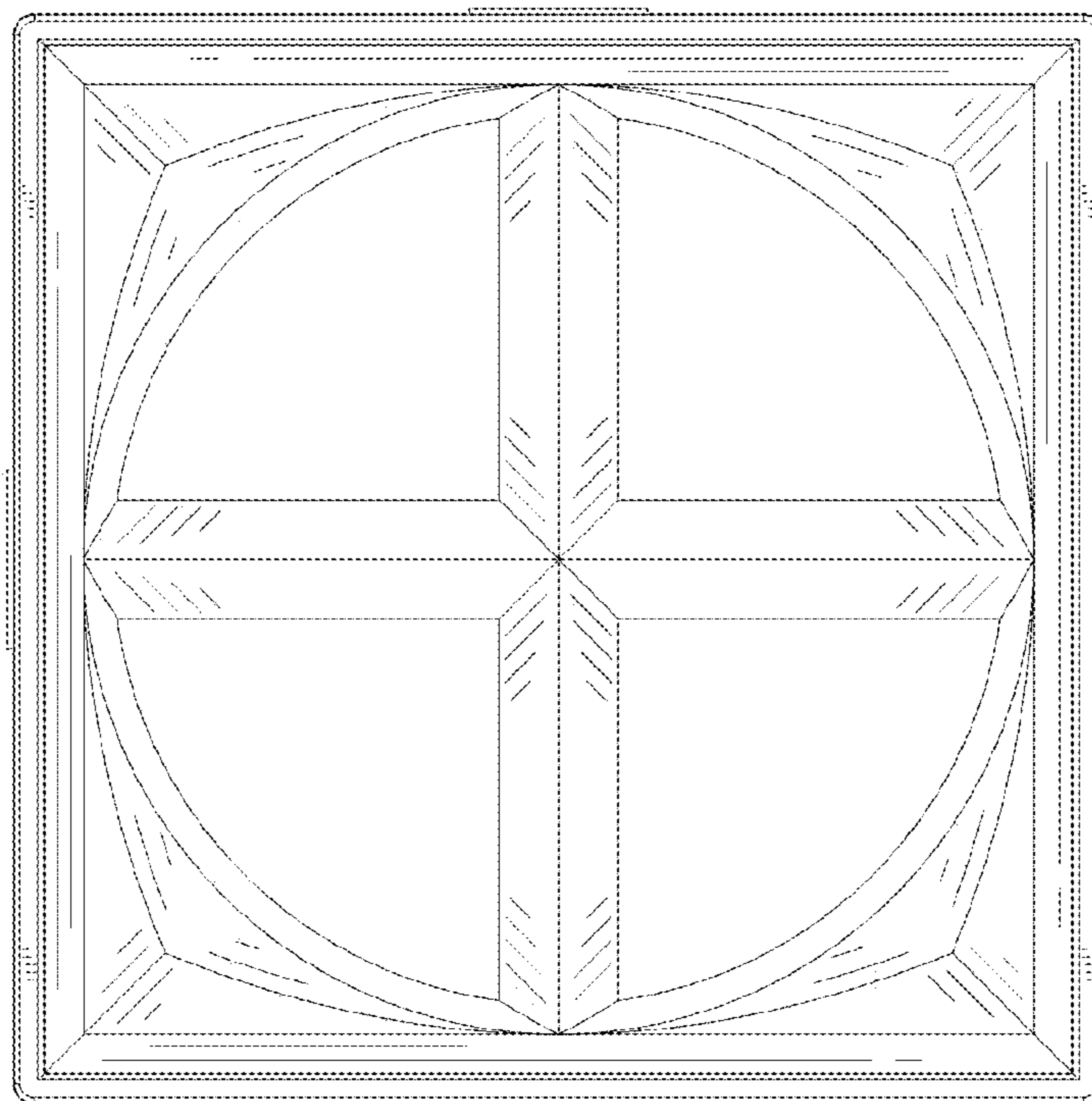

FIG. 107



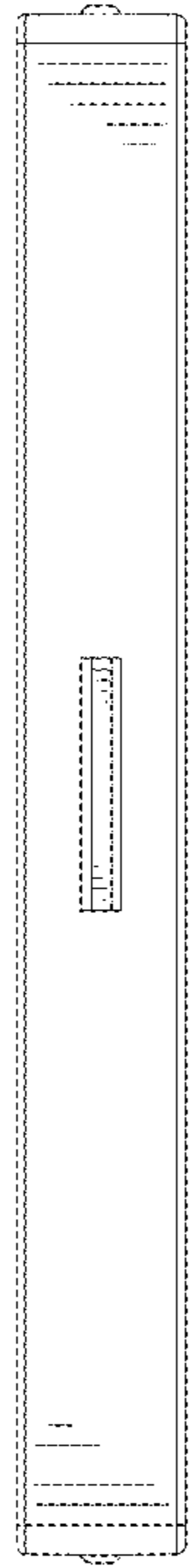

FIG. 108

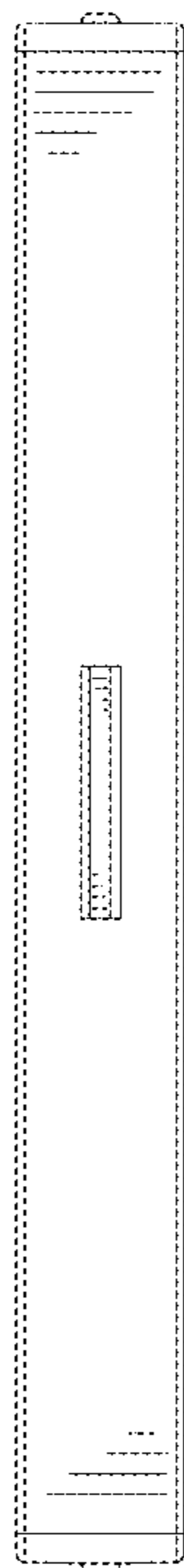

FIG. 109

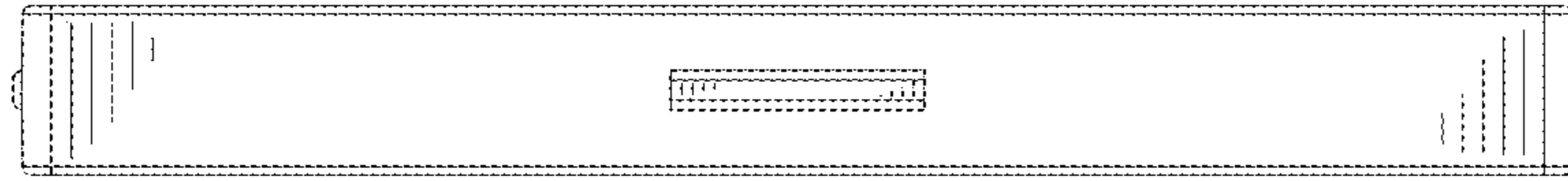

FIG. 110

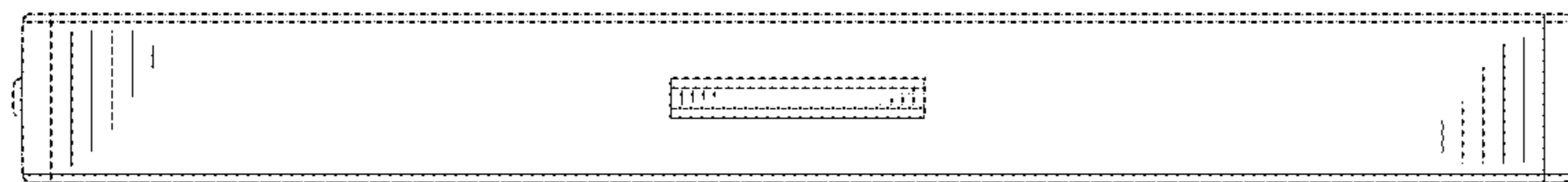

FIG. 111

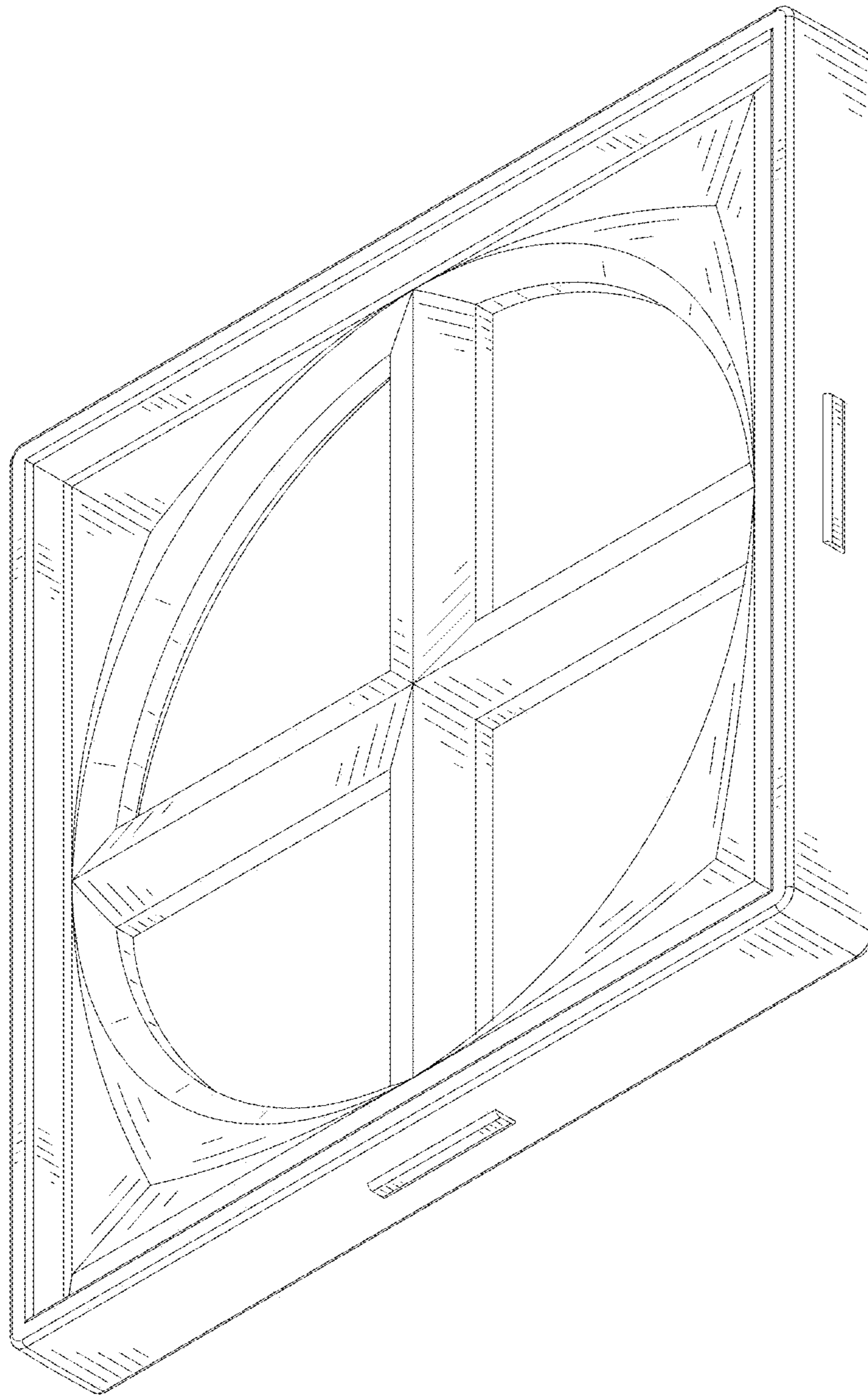

FIG. 112

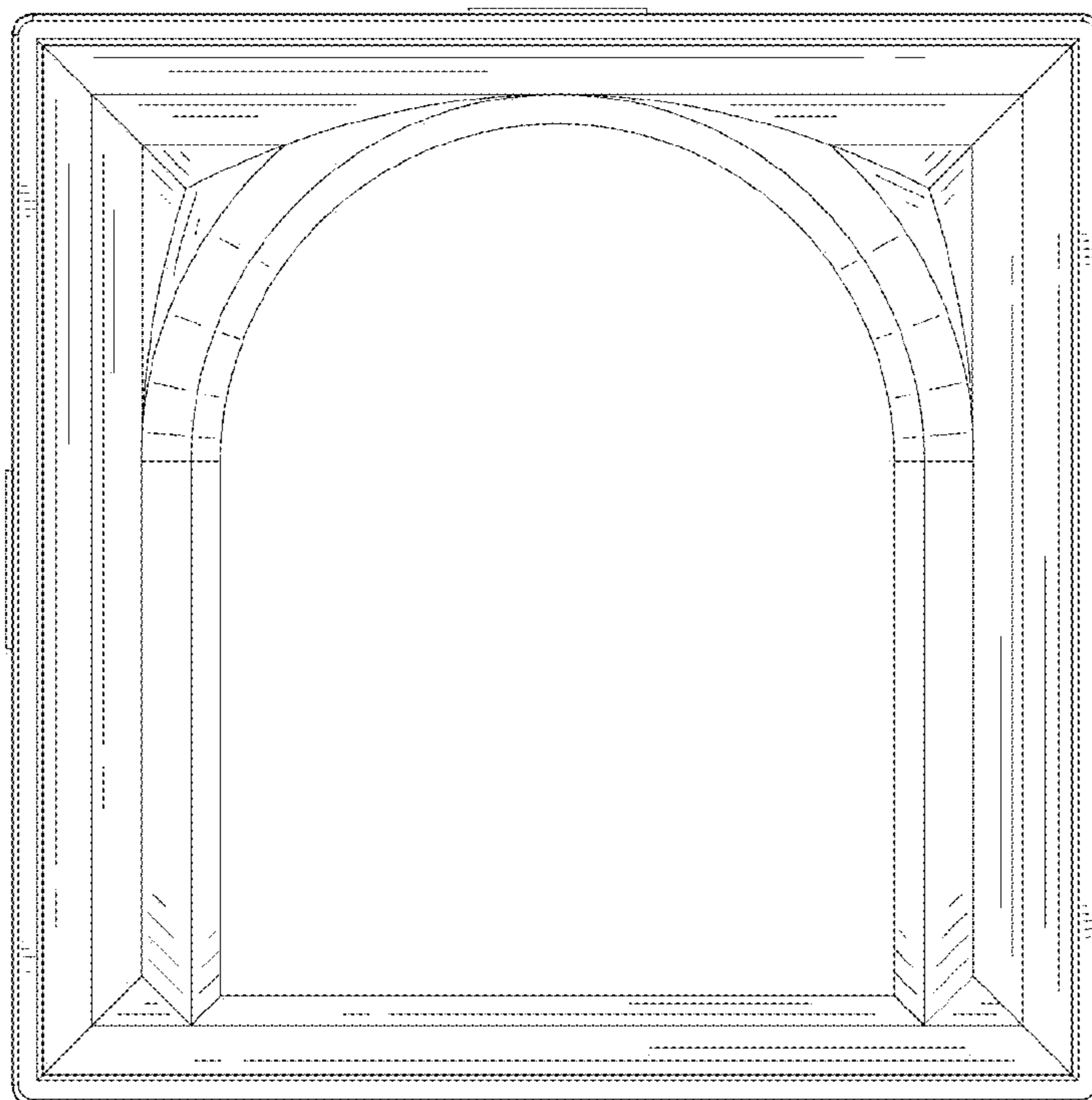

FIG. 113

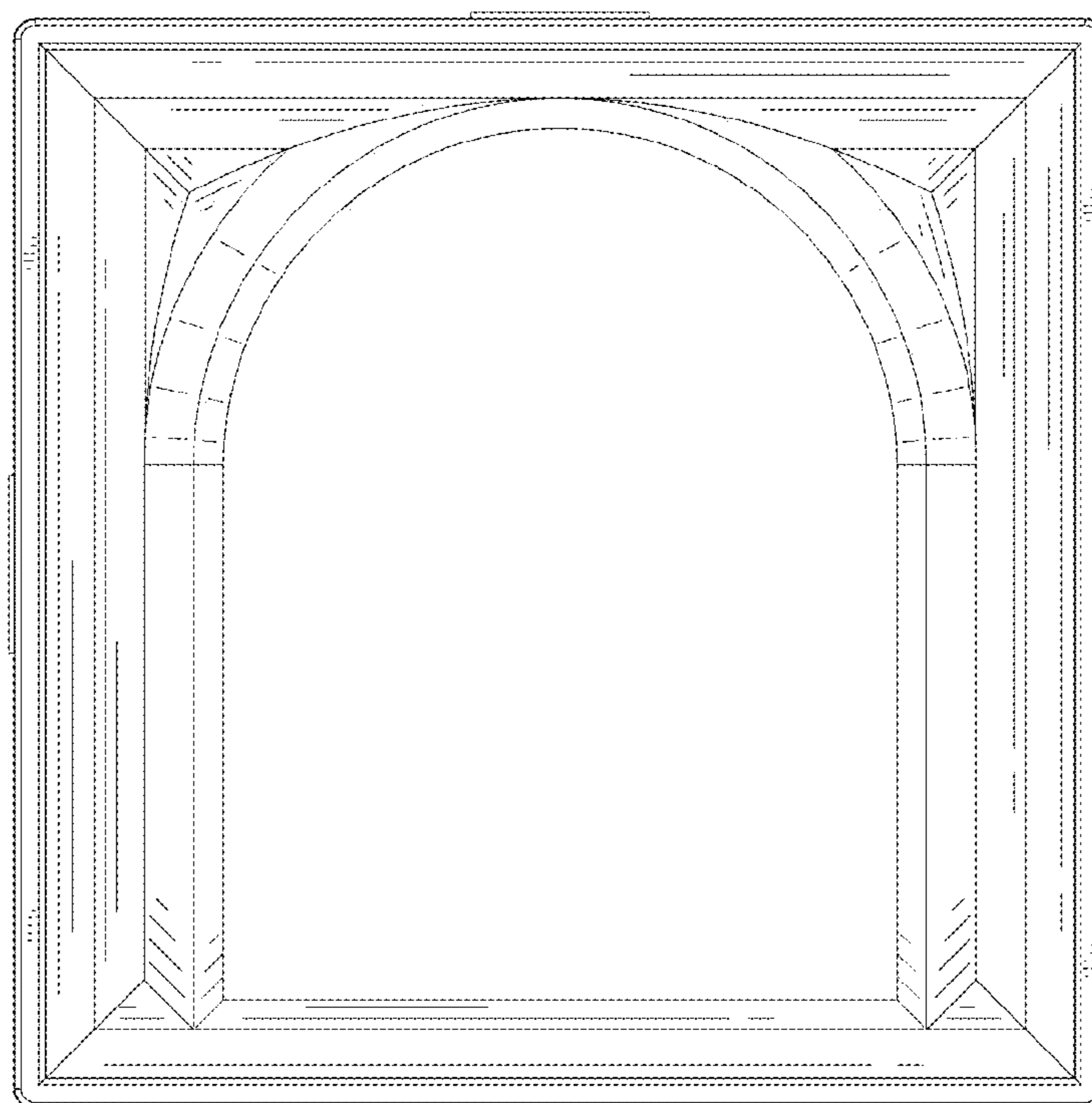

FIG. 114

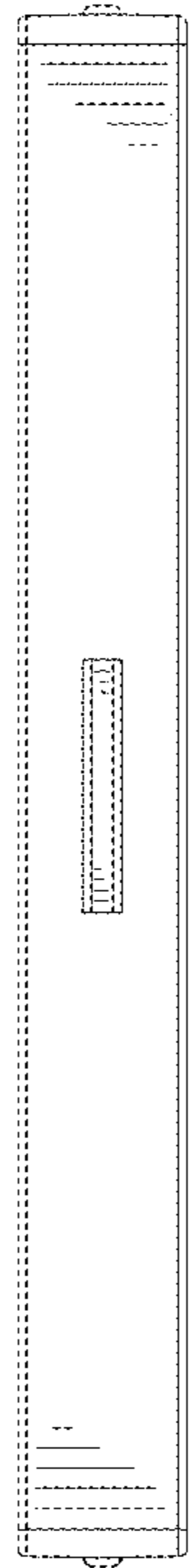

FIG. 115

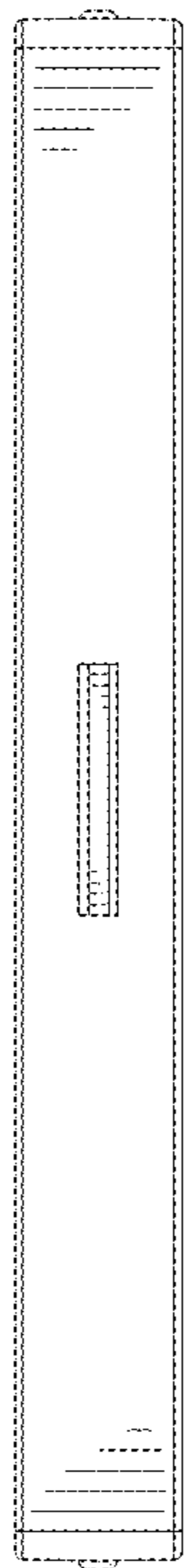

FIG. 116

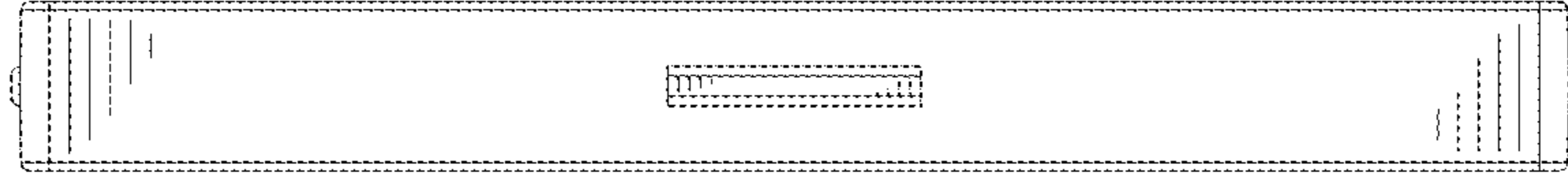

FIG. 117

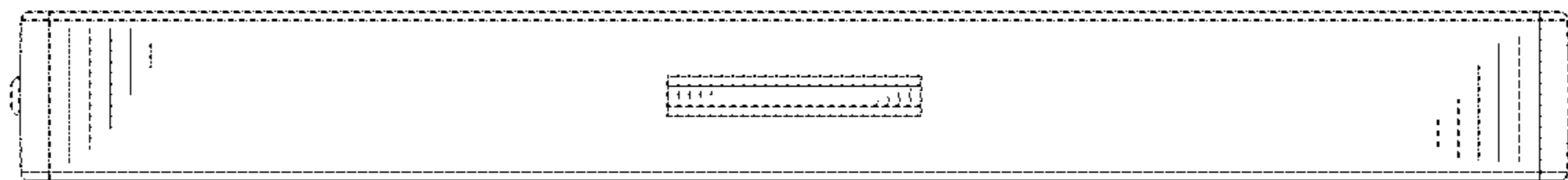

FIG. 118

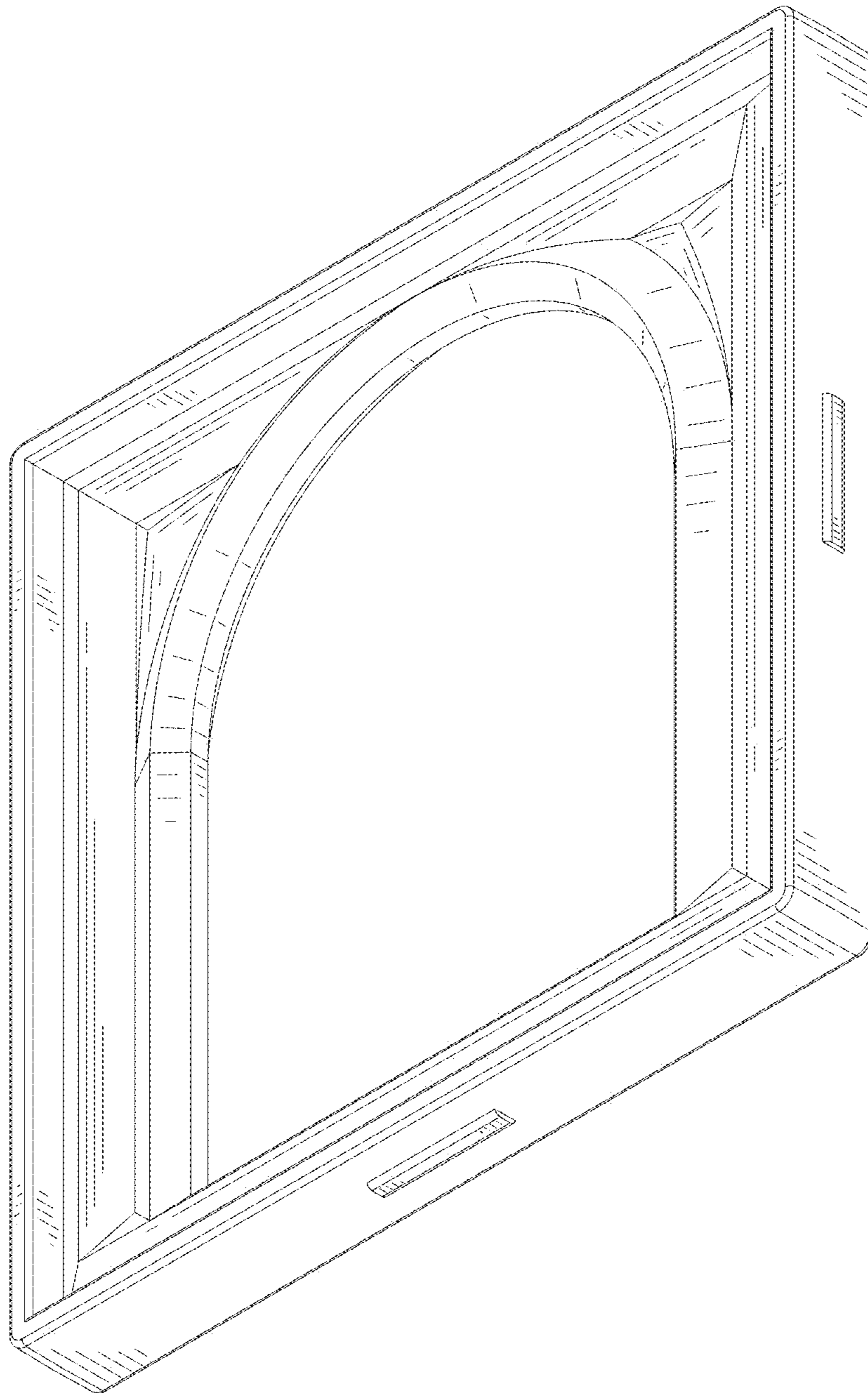

FIG. 119

