



US00D969202S

(12) **United States Design Patent**
Li

(10) **Patent No.:** **US D969,202 S**
(45) **Date of Patent:** **** Nov. 8, 2022**

(54) **TRIPOD**

(71) Applicant: **Feng Li, Jinshi (CN)**

(72) Inventor: **Feng Li, Jinshi (CN)**

(**) Term: **15 Years**

(21) Appl. No.: **29/841,487**

(22) Filed: **Jun. 7, 2022**

(51) **LOC (13) Cl.** **16-05**

(52) **U.S. Cl.**
USPC **D16/244**

(58) **Field of Classification Search**
USPC D16/208–209, 219, 237, 242–250
CPC G03B 17/02; G03B 17/56; G03B 17/04;
G03B 17/561–566; G03B 15/03; H04N
5/2251; H04N 5/2252; H04N 5/2253;
H04N 5/2254; G02B 7/02; G02B 7/04;
G02B 7/14

See application file for complete search history.

(56) **References Cited**

U.S. PATENT DOCUMENTS

D532,436 S	*	11/2006	Kruse	D16/244
D718,365 S	*	11/2014	Kim	D16/244
D840,465 S	*	2/2019	Chun	D16/244
D860,298 S	*	9/2019	Balmer	D16/244
D865,039 S	*	10/2019	Chen	D16/242
D866,648 S	*	11/2019	Marcon	D16/244
D882,672 S	*	4/2020	Xia	D16/243
D893,582 S	*	8/2020	Vitale	D16/244
D900,918 S	*	11/2020	Zeng	D16/244
D911,425 S	*	2/2021	Shan	D16/237
D916,173 S		4/2021	Zeng		
D916,174 S		4/2021	Gong		

D917,604 S		4/2021	Zeng		
D918,286 S	*	5/2021	Lin	D16/244
D946,563 S	*	3/2022	Law	D16/244
D960,966 S	*	8/2022	Tan	D16/244

* cited by examiner

Primary Examiner — Ramzi Almatrahi

(74) *Attorney, Agent, or Firm* — Rumit Ranjit Kanakia

(57) **CLAIM**

The ornamental design for a tripod, as shown and described.

DESCRIPTION

FIG. 1 is a bottom, front and left side perspective view of a tripod showing my new design;
 FIG. 2 is a top, back and right side perspective view thereof;
 FIG. 3 is a front view thereof;
 FIG. 4 is a back view thereof;
 FIG. 5 is a left side view thereof;
 FIG. 6 is a right side view thereof;
 FIG. 7 is a top view thereof;
 FIG. 8 is a bottom view thereof;
 FIG. 9 is a bottom, front and left side perspective view thereof, shown with the tripod in an extended configuration;
 FIG. 10 is a bottom perspective view thereof, shown with the tripod in condition of use;
 FIG. 11 is an enlarged view of portion 11 shown in FIG. 1;
 FIG. 12 is an enlarged view of portion 12 shown in FIG. 2;
 and,
 FIG. 13 is an enlarged view of portion 13 shown in FIG. 2.
 The broken lines depict portions of the tripod that form no part of the claimed design. The dot-dash broken lines encircling an enlargement portion of the design forms no part of the claimed design.

1 Claim, 13 Drawing Sheets

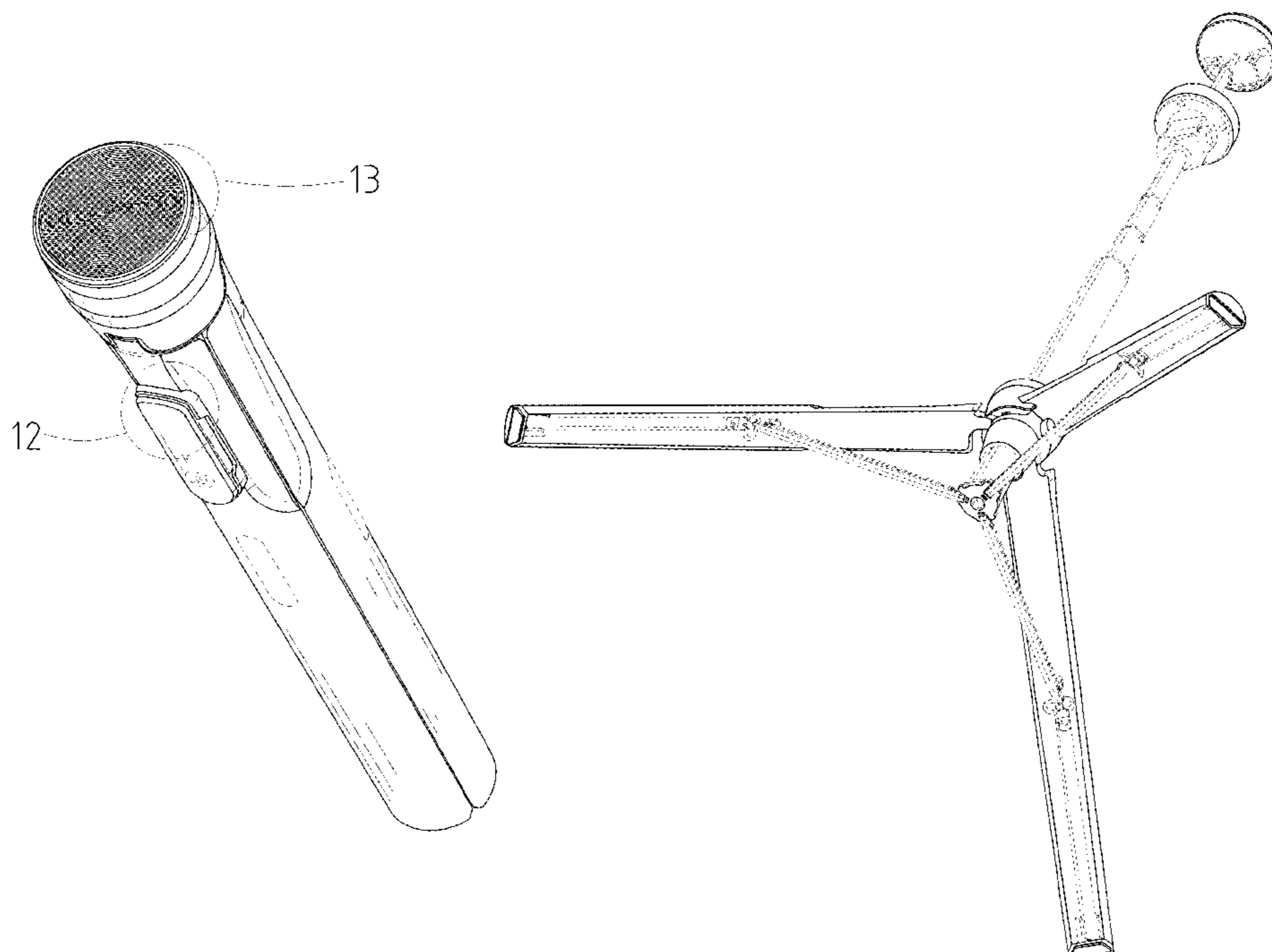

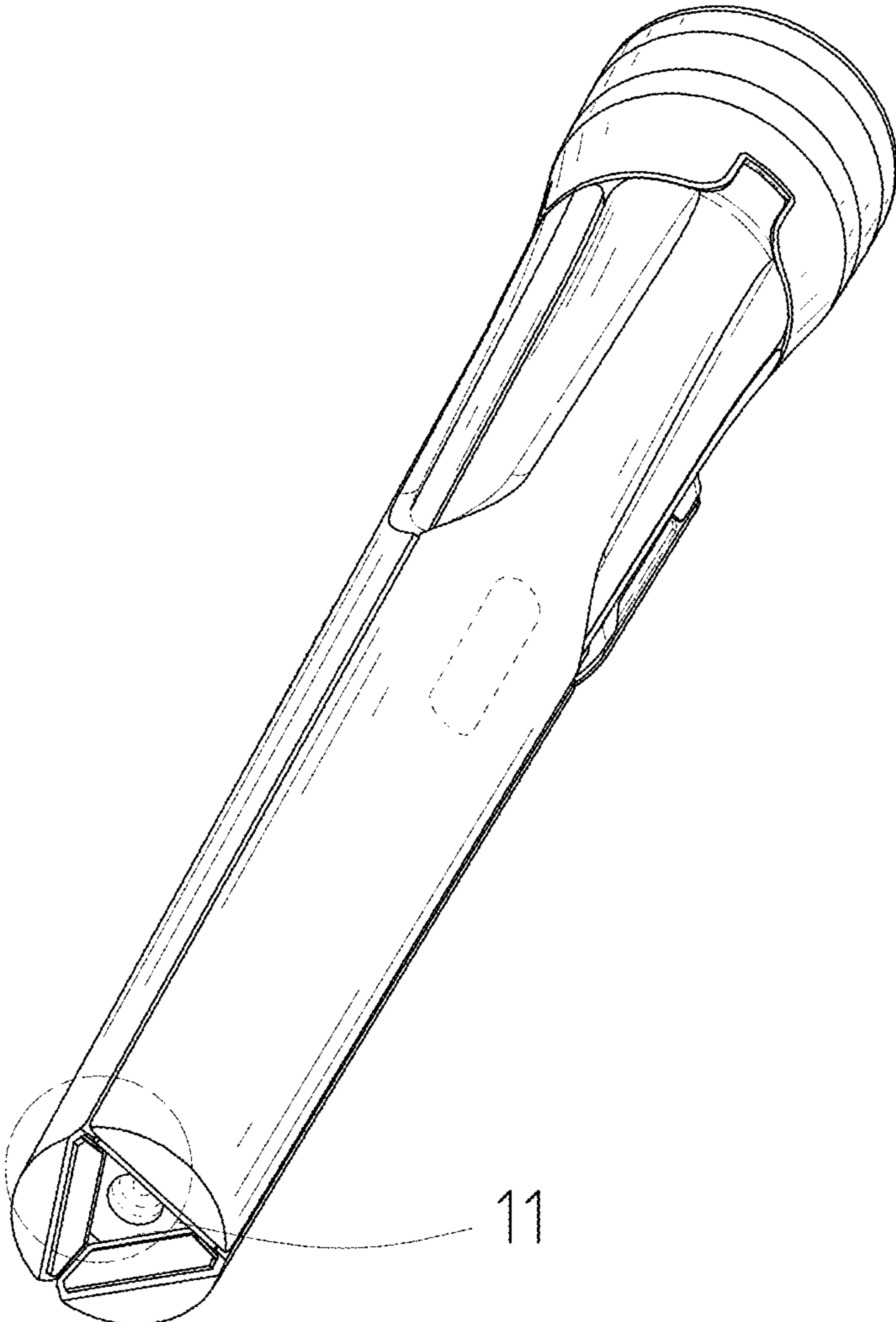

FIG. 1

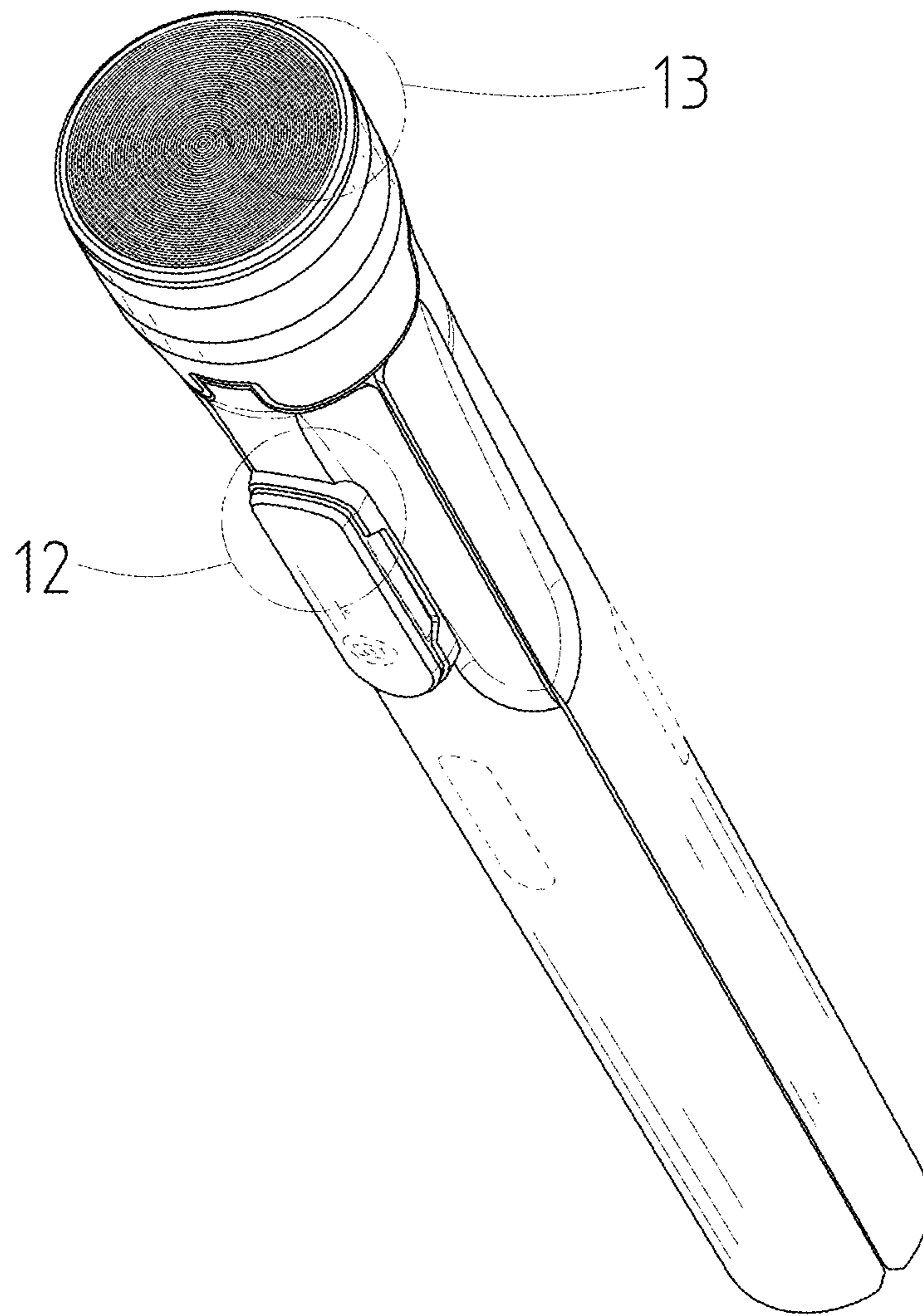

FIG. 2

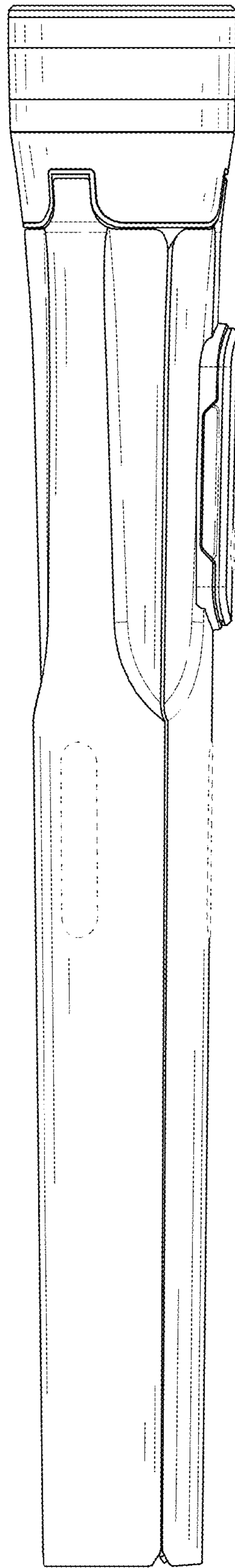

FIG. 3

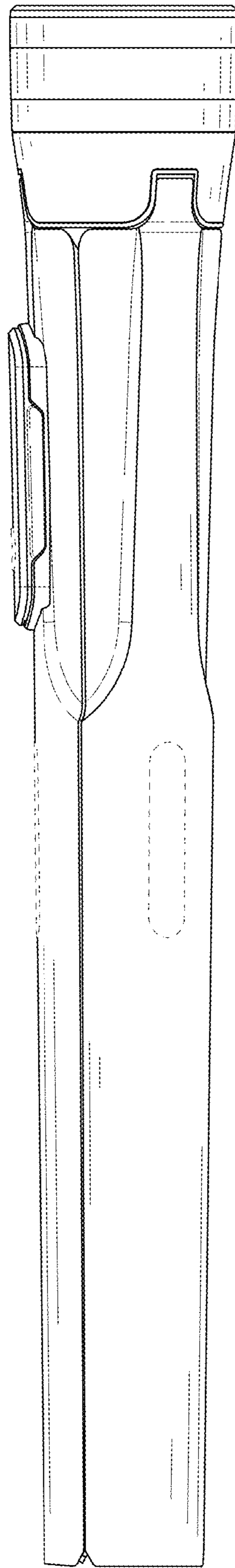

FIG. 4

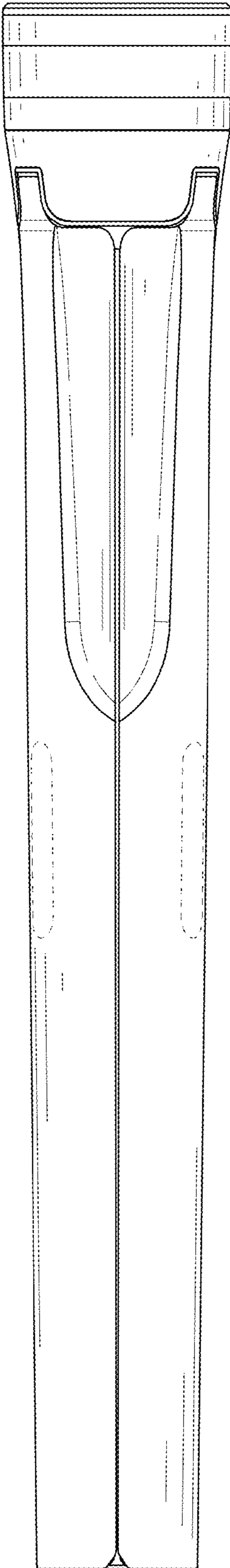

FIG. 5

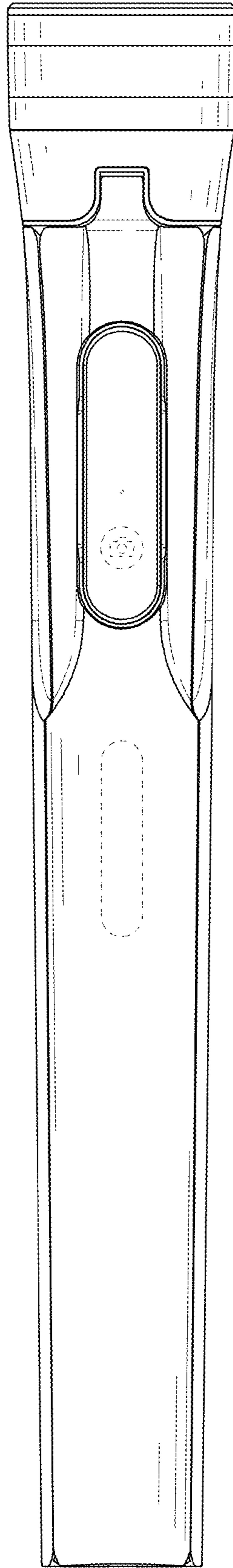

FIG. 6

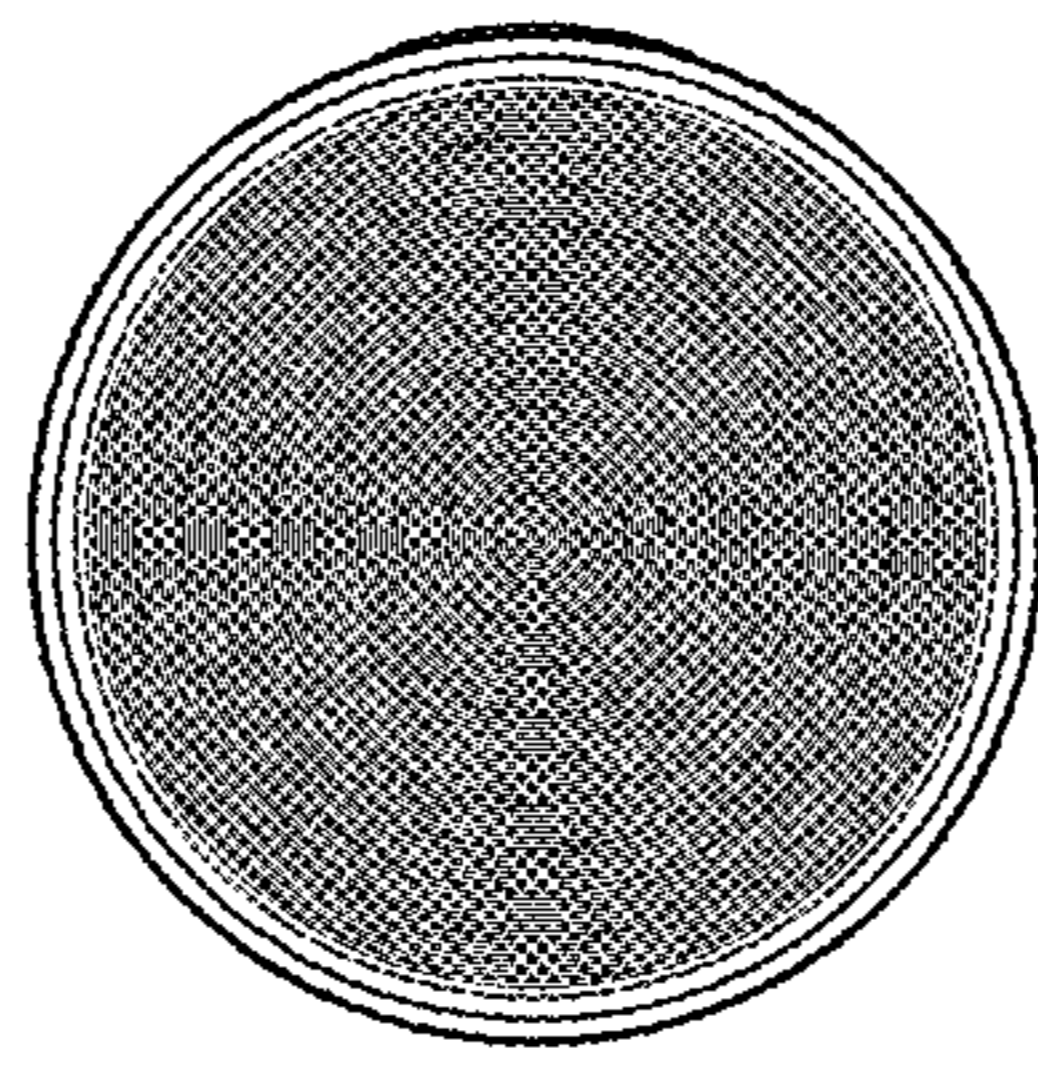

FIG. 7

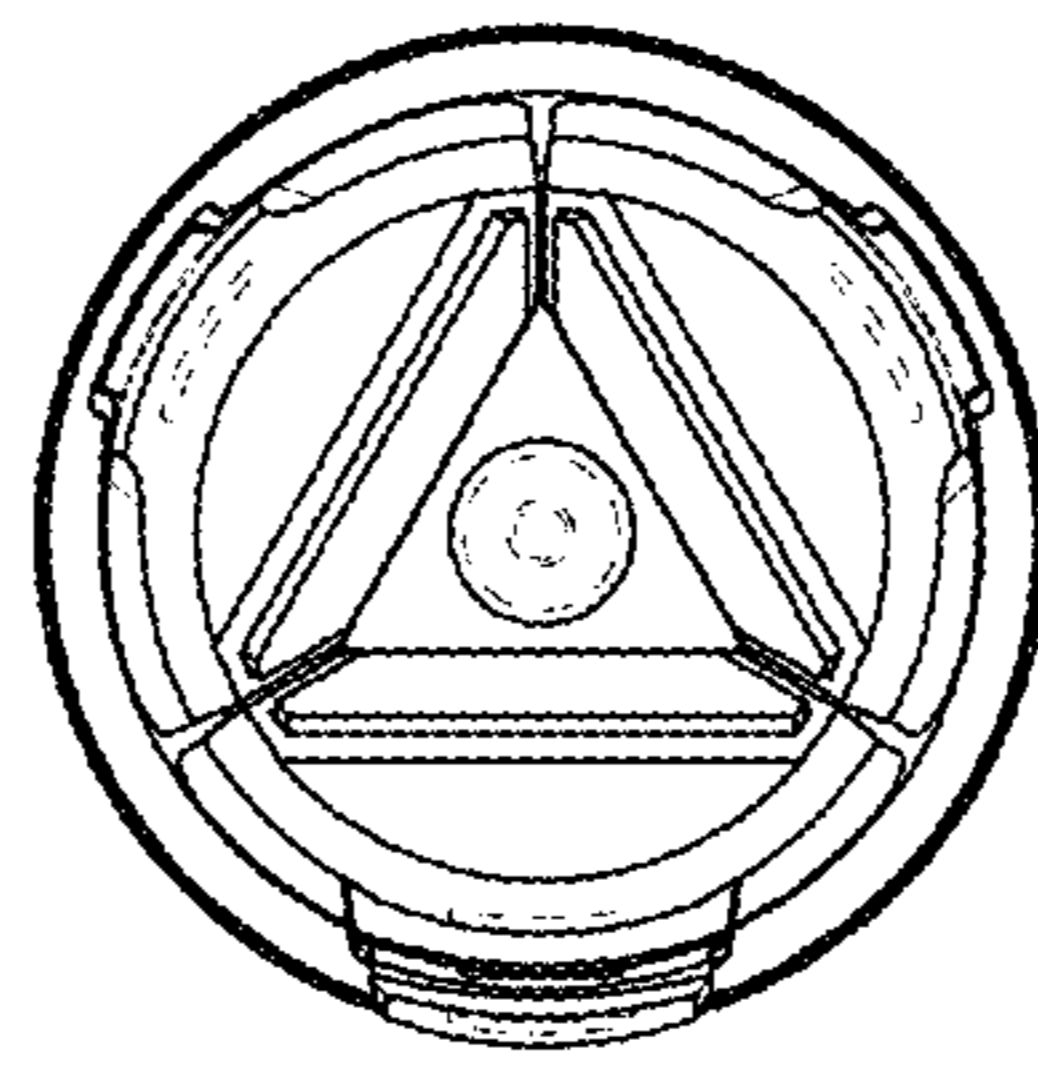

FIG. 8

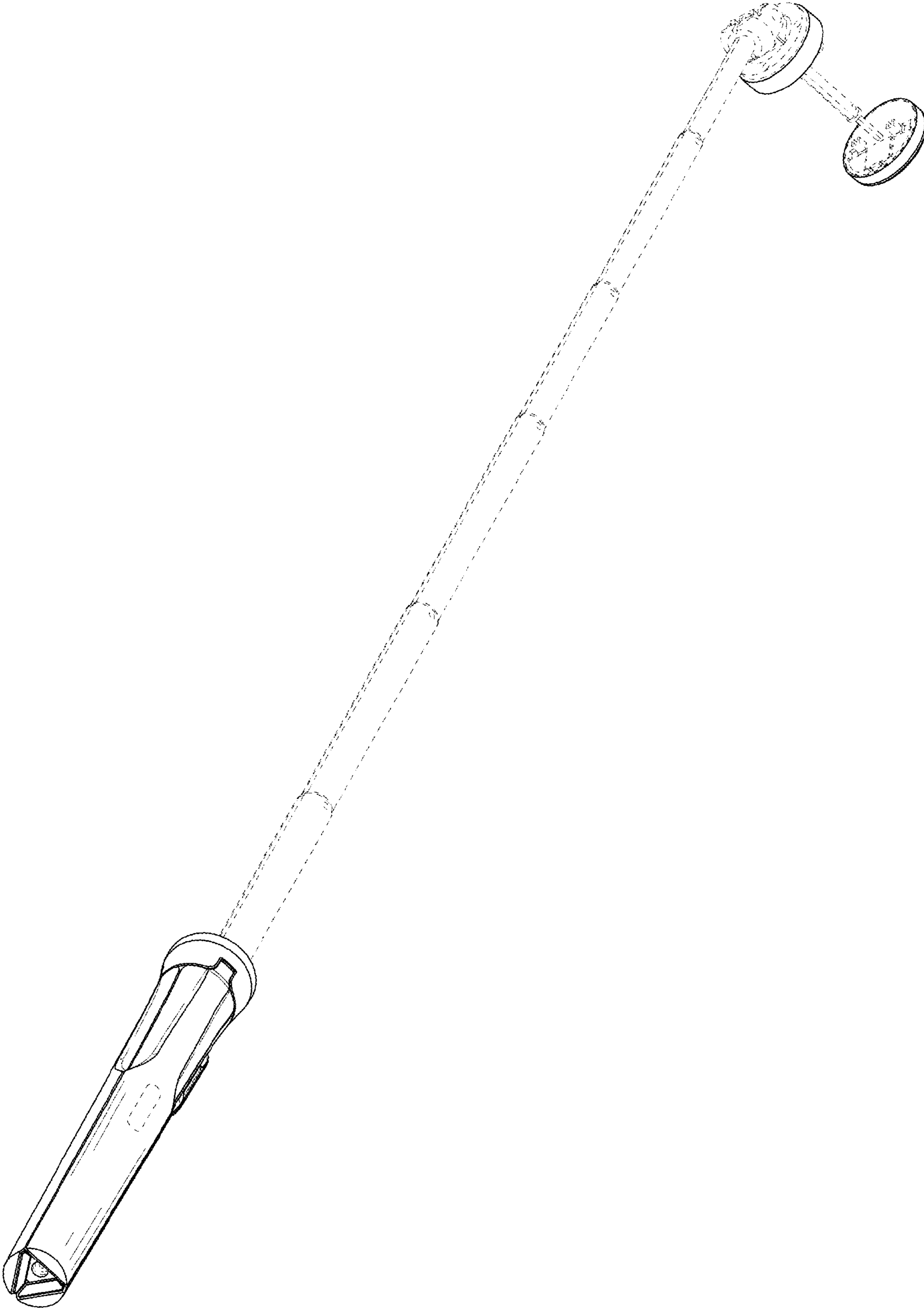

FIG. 9

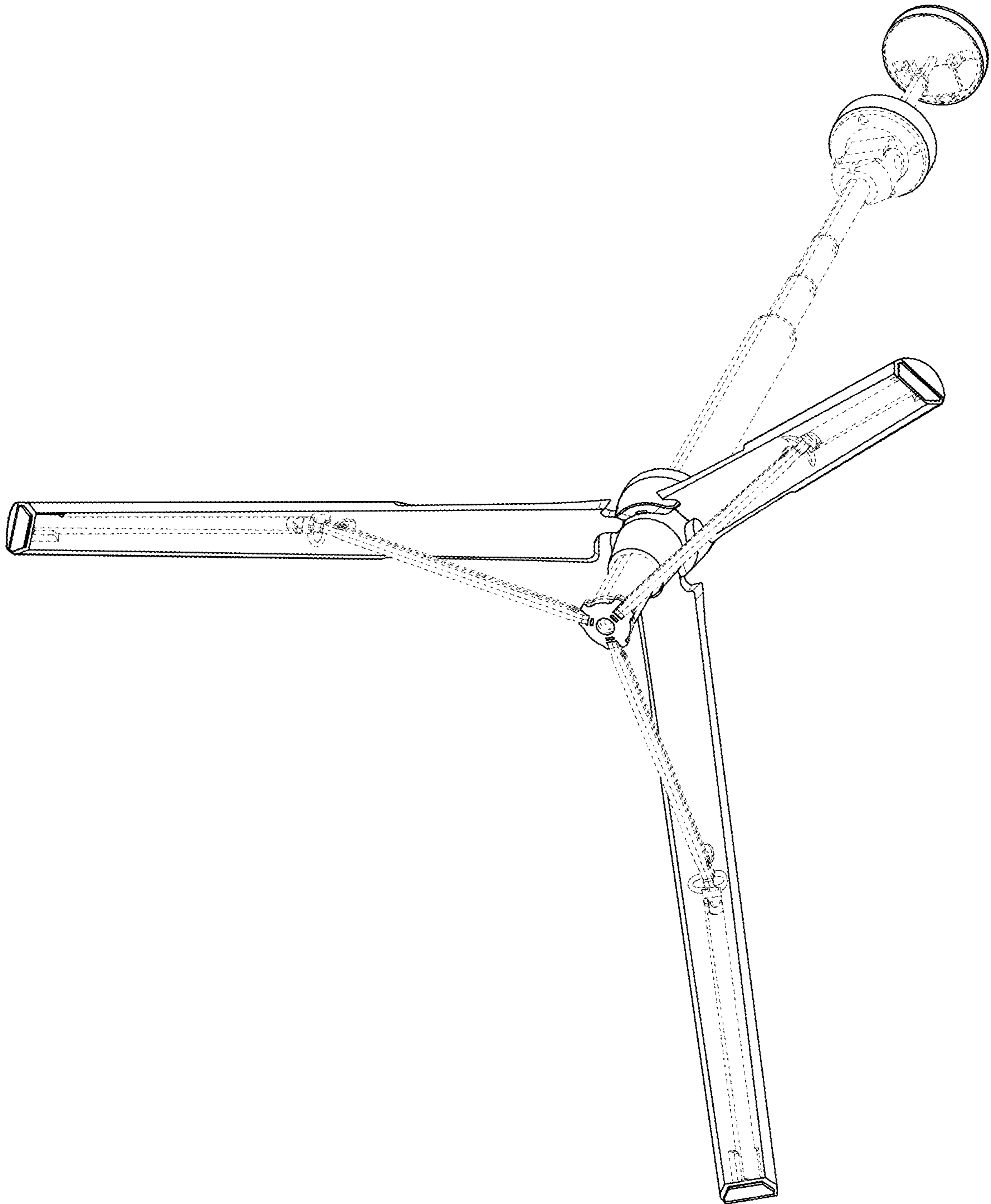

FIG. 10

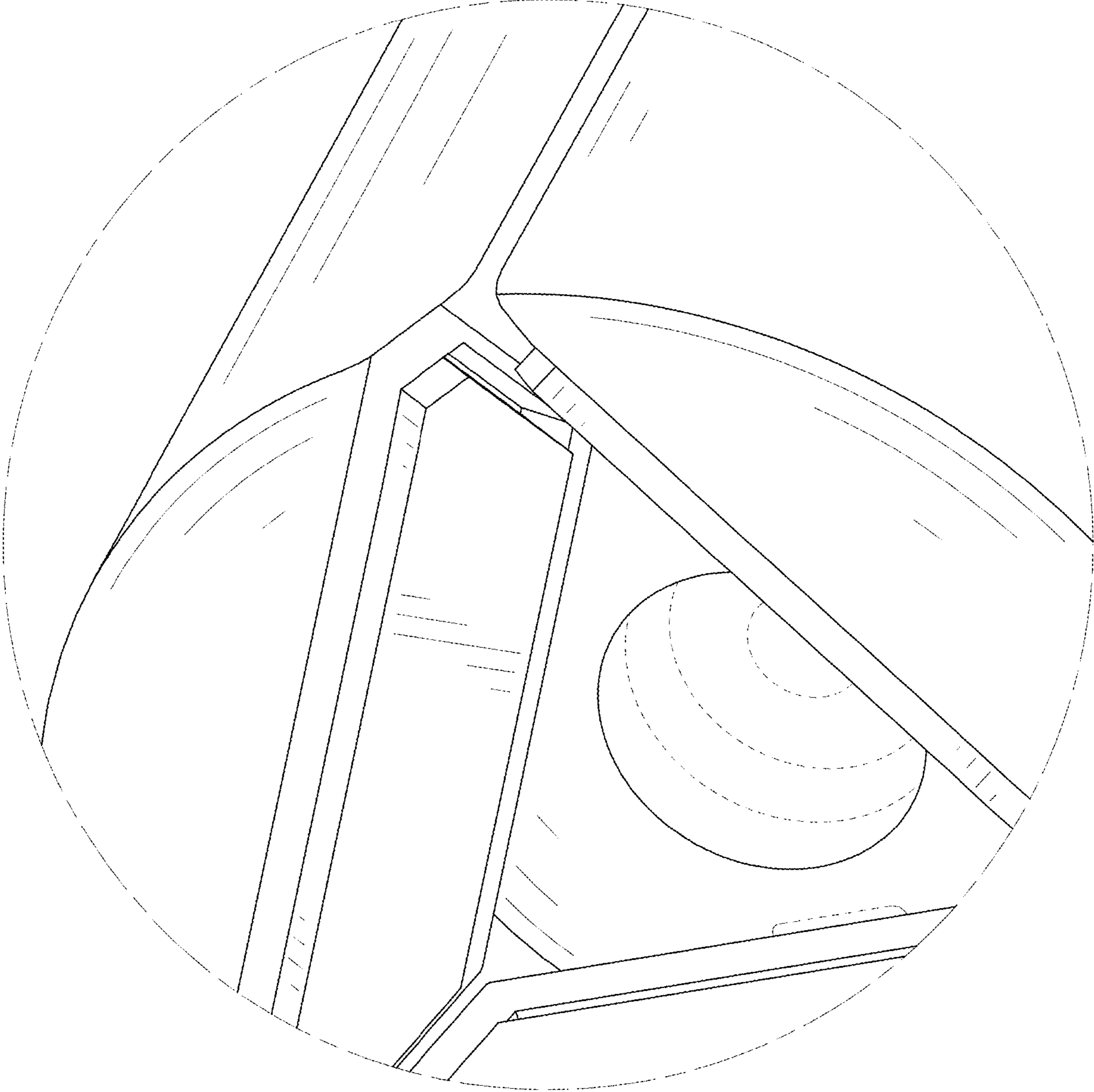

FIG. 11

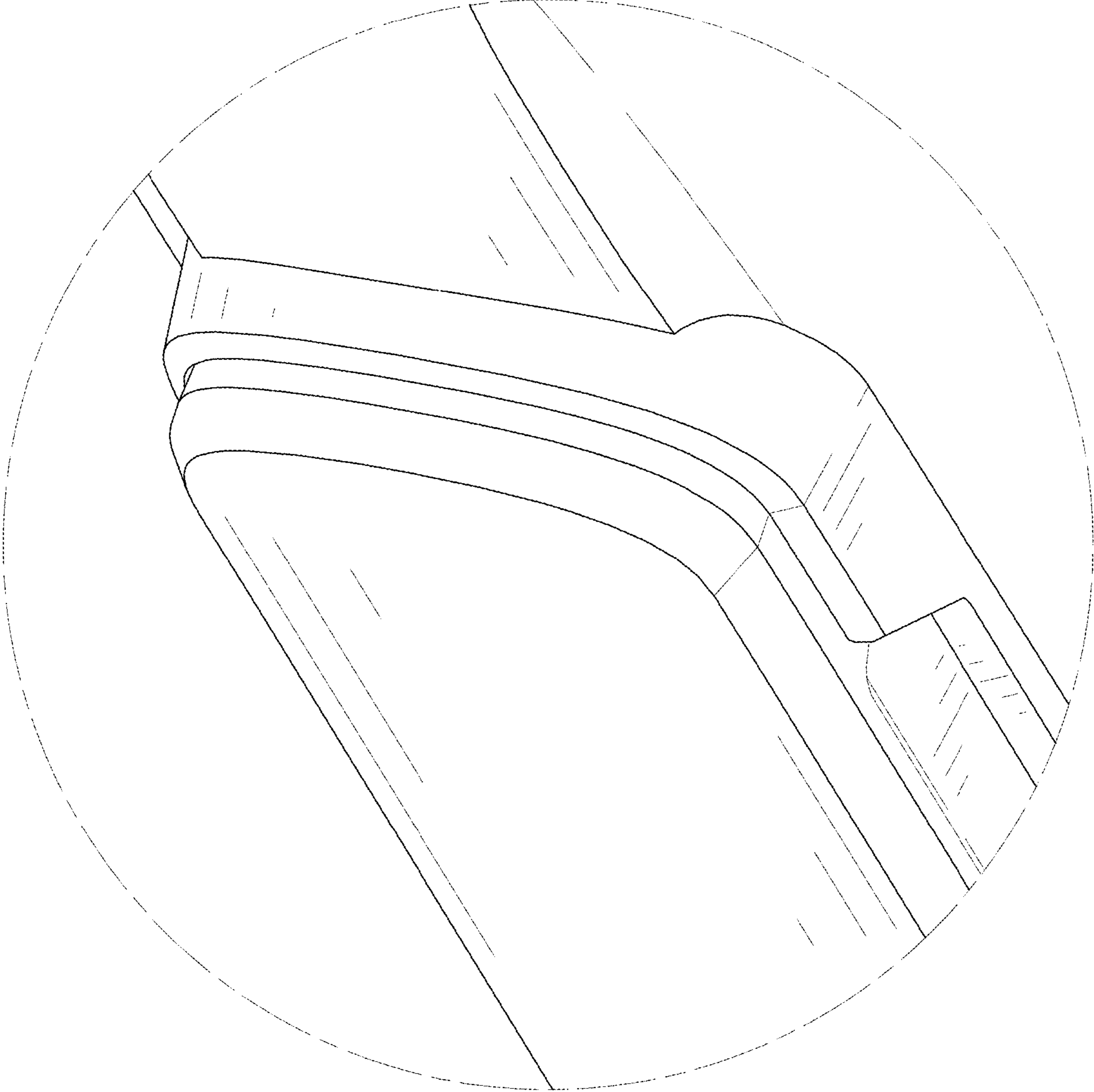

FIG. 12

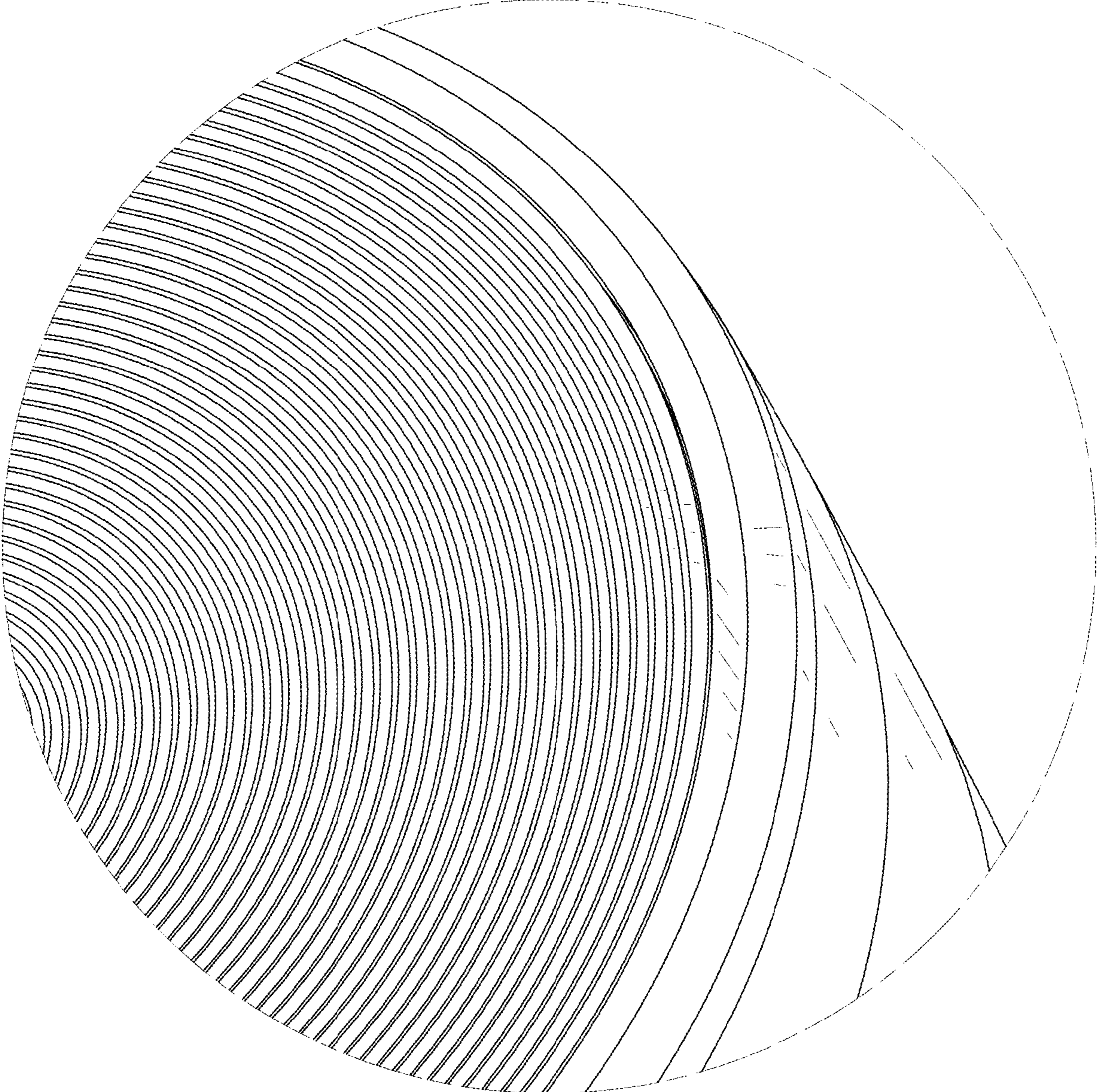

FIG. 13