

US00D969178S

(12) **United States Design Patent** (10) **Patent No.:** **US D969,178 S**  
**Kim et al.** (45) **Date of Patent:** **\*\* Nov. 8, 2022**

(54) **DOOR WITH REFRIGERATOR AND DELIVERY STORAGE BOX**

- (71) Applicant: **LG ELECTRONICS INC.**, Seoul (KR)
- (72) Inventors: **Hyunchul Kim**, Seoul (KR); **Insun Yeo**, Seoul (KR); **Kiyeal Seo**, Seoul (KR); **Wook Shin**, Seoul (KR); **Eugene Myung**, Seoul (KR); **Junghoon Lee**, Seoul (KR)
- (73) Assignee: **LG ELECTRONICS INC.**, Seoul (KR)
- (\*\*) Term: **15 Years**
- (21) Appl. No.: **29/728,249**
- (22) Filed: **Mar. 17, 2020**

(30) **Foreign Application Priority Data**

Oct. 2, 2019 (KR) ..... 30-2019-0047428

(51) **LOC (13) Cl.** ..... **15-07**

(52) **U.S. Cl.**  
USPC ..... **D15/81**

(58) **Field of Classification Search**

USPC ..... D25/48.1, 48.3, 199; D15/79-91; D6/663, 671.1-671.2; D99/28, 31, 33, 43  
 CPC ..... F25D 25/02; F25D 25/021; F25D 25/022; F25D 25/024; F25D 25/025; F25D 2323/00; F25D 2323/021; F25D 2323/024; F25D 2325/021; F25D 17/042; F25D 27/005; F25D 29/00; F25D 29/005; F25D 2300/00; F25D 2331/80; F25D 11/00; F25D 11/02;

(Continued)

(56) **References Cited**

**U.S. PATENT DOCUMENTS**

- 2,111,411 A \* 3/1938 Spreen ..... F25D 25/02 126/340
- 2,815,649 A \* 12/1957 Di Angelus ..... F25D 25/02 312/351

(Continued)

**OTHER PUBLICATIONS**

LockTec, Refrigerated pickup station—cool lockers by LockTec, (site visited Apr. 29, 2022), LockTec Website, URL:<https://www.locktec.com/en/products/cool-lockers/#&gid=lightbox-group-784&pid=7> (Year: 2022).\*

(Continued)

*Primary Examiner* — Calvin E Vansant

*Assistant Examiner* — Mark T. Philipps

(74) *Attorney, Agent, or Firm* — Birch, Stewart, Kolasch & Birch, LLP

(57) **CLAIM**

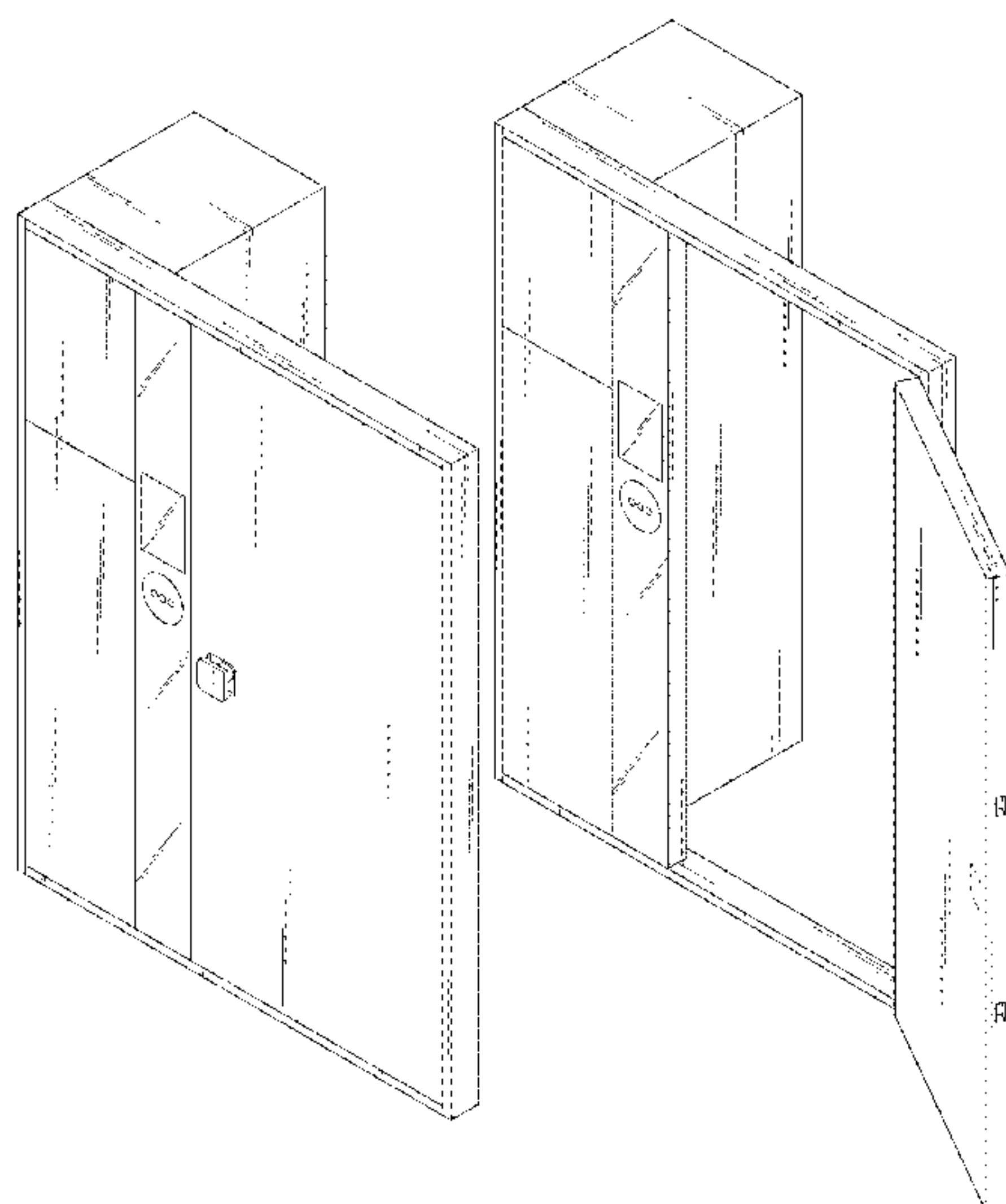
We claim the ornamental design for a door with refrigerator and delivery storage box, as shown and described.

**DESCRIPTION**

FIG. 1 is a perspective view of a door with refrigerator and delivery storage box showing the new design;  
 FIG. 2 is a front elevation view thereof;  
 FIG. 3 is a rear elevation view thereof;  
 FIG. 4 is a left-side elevation view thereof;  
 FIG. 5 is a right-side elevation view thereof;  
 FIG. 6 is a top plan view thereof;  
 FIG. 7 is a bottom plan view thereof;  
 FIG. 8 is a perspective view showing a state of the delivery storage opened;  
 FIG. 9 is a perspective view showing a state of the refrigerator opened; and,  
 FIG. 10 is a perspective view showing a state of the main door opened.

The broken lines shown in FIGS. 3 and 10 depict portions of the door with refrigerator and delivery storage box that form no part of the claimed design.

**1 Claim, 10 Drawing Sheets**



- (58) **Field of Classification Search**  
 CPC ..... F25D 11/025; F25D 23/00; F25D 23/02;  
 F25D 23/04; F25D 23/12; F25D 23/028;  
 A47F 3/04; A47F 3/0404  
 See application file for complete search history.

(56) **References Cited**

U.S. PATENT DOCUMENTS

3,971,231 A \* 7/1976 Derry ..... F25D 3/12  
 62/449  
 4,725,107 A \* 2/1988 Appleton ..... F25D 11/02  
 312/283  
 D363,618 S \* 10/1995 Cramer ..... D6/671.1  
 D607,019 S \* 12/2009 Becke ..... D15/87  
 D617,353 S \* 6/2010 Jeon ..... D15/86  
 D647,544 S \* 10/2011 Kristiansen ..... D15/86  
 D659,725 S \* 5/2012 Wolfe ..... D15/85  
 D714,359 S \* 9/2014 Kim ..... D15/85  
 D721,746 S \* 1/2015 Ryu ..... D15/86  
 D785,055 S \* 4/2017 Kim ..... D15/85  
 D786,316 S \* 5/2017 Lee ..... D15/85  
 D786,319 S \* 5/2017 Kwak ..... D15/86  
 D791,202 S \* 7/2017 Kwak ..... D15/91  
 D799,148 S \* 10/2017 Crosby ..... D99/28  
 D811,686 S \* 2/2018 Crosby ..... D99/28  
 D818,012 S \* 5/2018 Kim ..... F25D 23/00  
 D15/91  
 D824,965 S \* 8/2018 Lee ..... D15/91  
 D876,044 S \* 2/2020 Sisco ..... D99/28  
 D876,491 S \* 2/2020 Yu ..... F25D 23/025  
 D15/79  
 D880,543 S \* 4/2020 Luchetta ..... F25D 17/062  
 D15/91  
 D905,766 S \* 12/2020 Vernon ..... D15/79  
 D908,748 S \* 1/2021 Lee ..... D15/91

D912,338 S \* 3/2021 Kim ..... D32/10  
 D914,772 S \* 3/2021 Kim ..... F25D 25/025  
 D15/89  
 D921,711 S \* 6/2021 Lee ..... D15/85  
 D924,278 S \* 7/2021 Choi ..... F25D 25/025  
 D15/79  
 D925,619 S \* 7/2021 Kim ..... D15/91  
 D928,853 S \* 8/2021 Kim ..... D15/91  
 D929,473 S \* 8/2021 Yeo ..... F25D 23/02  
 D15/85  
 D943,646 S \* 2/2022 Kim ..... F25D 25/025  
 D15/91  
 D947,256 S \* 3/2022 Myung ..... F25D 25/025  
 D15/79  
 2010/0256800 A1 \* 10/2010 Heffron ..... G07F 11/62  
 312/327  
 2014/0318157 A1 \* 10/2014 Knudsen ..... F25D 11/02  
 62/62  
 2017/0061373 A1 \* 3/2017 Hara ..... G06Q 10/0836  
 2017/0188542 A1 \* 7/2017 Dix ..... A01K 1/035  
 2018/0172337 A1 \* 6/2018 Choi ..... F25D 23/02  
 2019/0271500 A1 \* 9/2019 Lee ..... F25D 27/005  
 2020/0123824 A1 \* 4/2020 Yang ..... A47B 87/0284  
 2020/0408028 A1 \* 12/2020 Schmider ..... E05G 1/04  
 2021/0217261 A1 \* 7/2021 Green ..... G08C 17/02

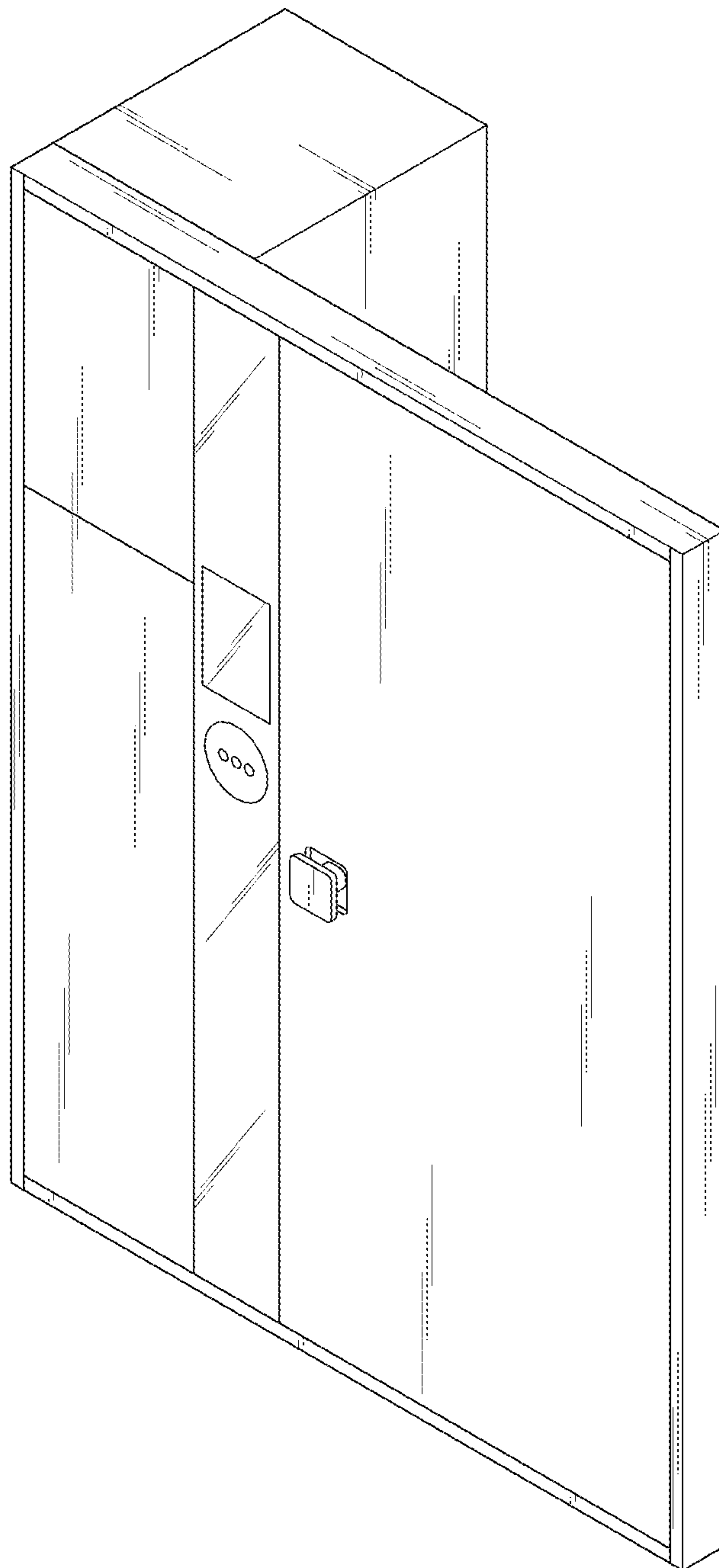
OTHER PUBLICATIONS

Smiota, Play It Cool With Refrigerated Package Lockers, (Jul. 17, 2018), Smiota website, URL:<<https://smiota.com/resources/play-cool-refrigerated-package-lockers/>> (Year: 2018).\*

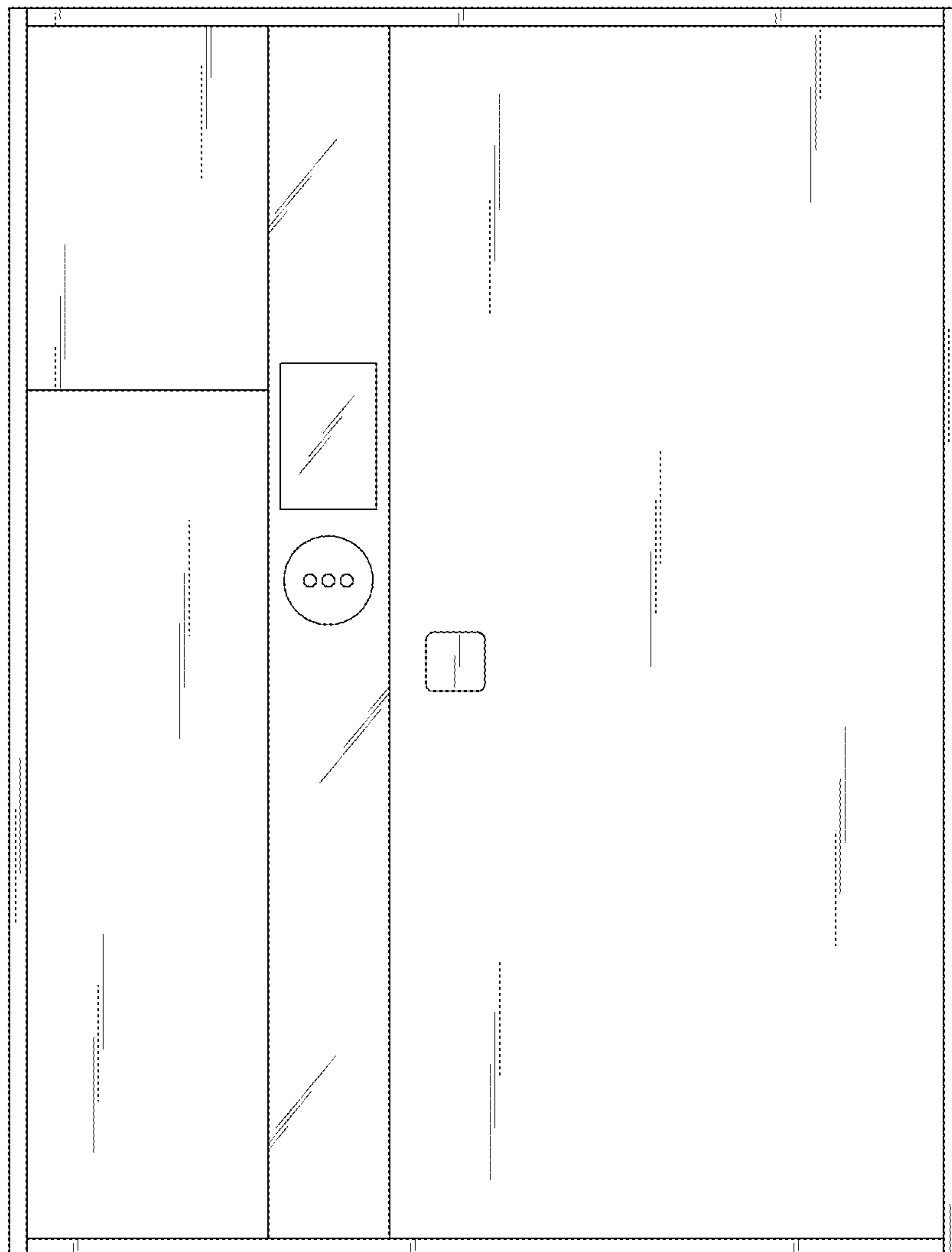
Luxer One, Luxer Lockers: Designed & Built in the USA, (site visited Apr. 29, 2022), Luxer One Website, URL:<<https://www.luxerone.com/product/luxer-lockers/>> (Year: 2022).\*

\* cited by examiner

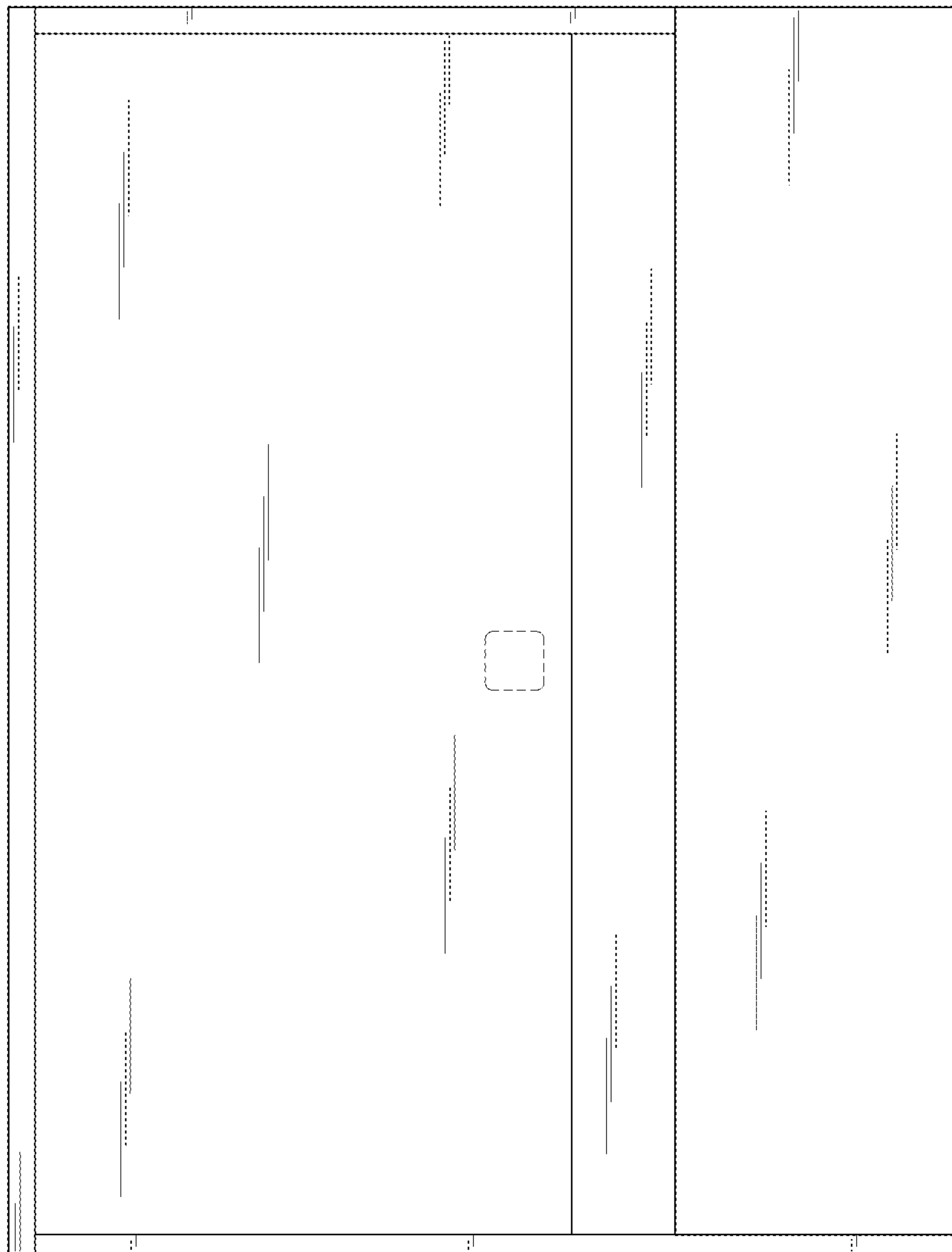
*FIG. 1*



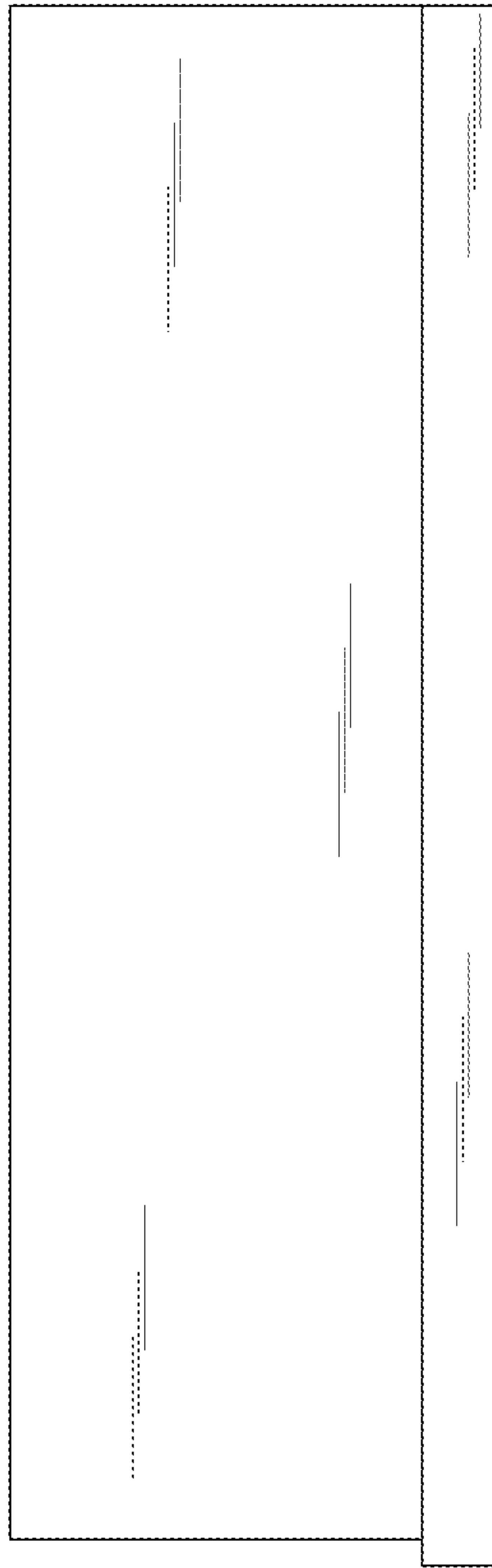
*FIG. 2*



*FIG. 3*

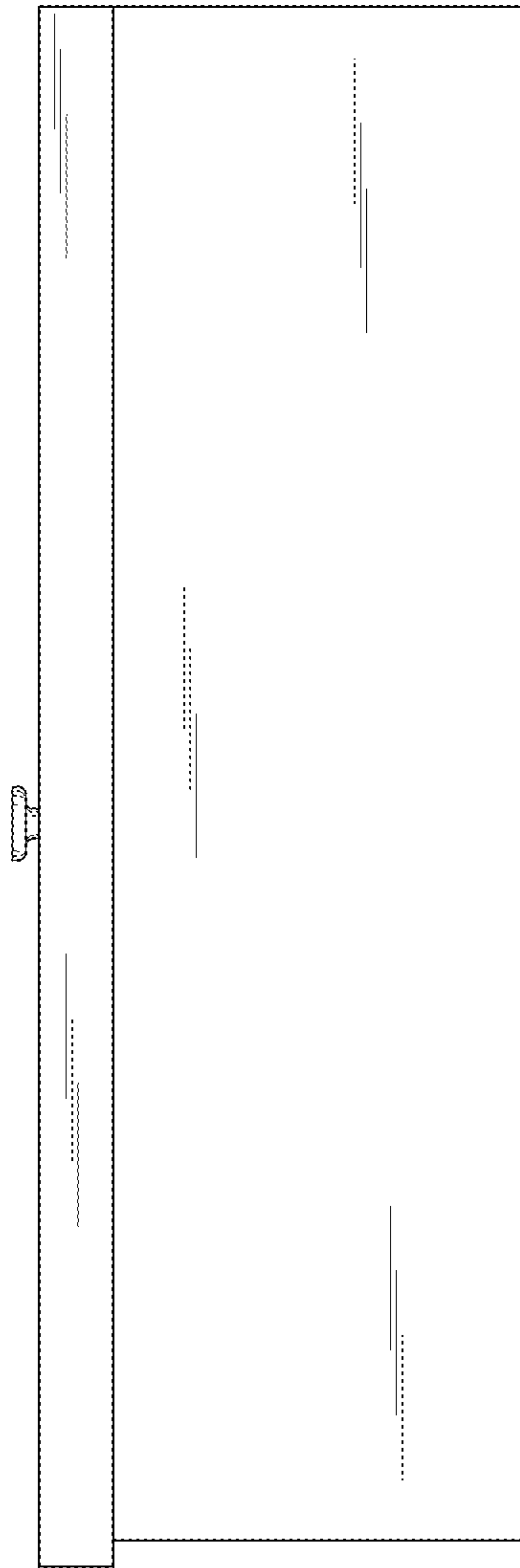


*FIG. 4*

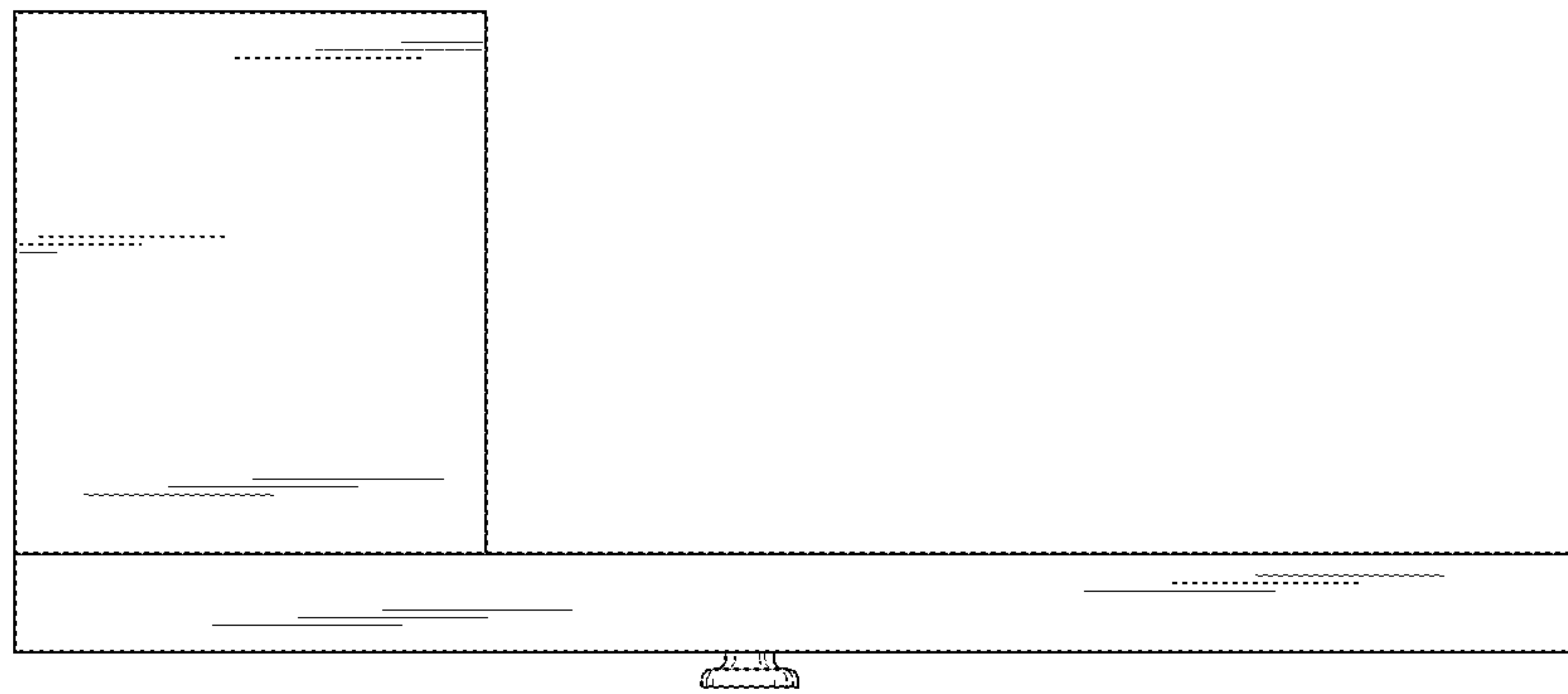




*FIG. 5*

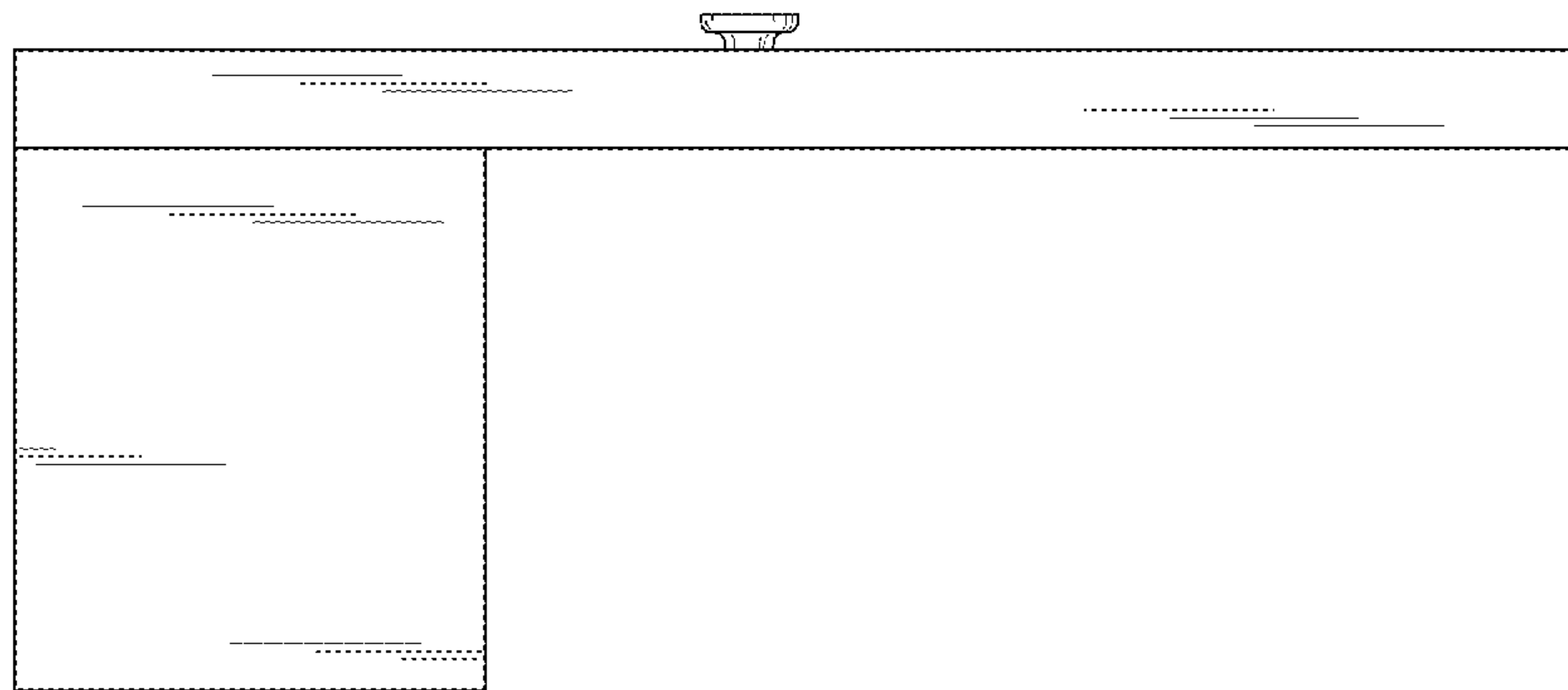


*FIG. 6*

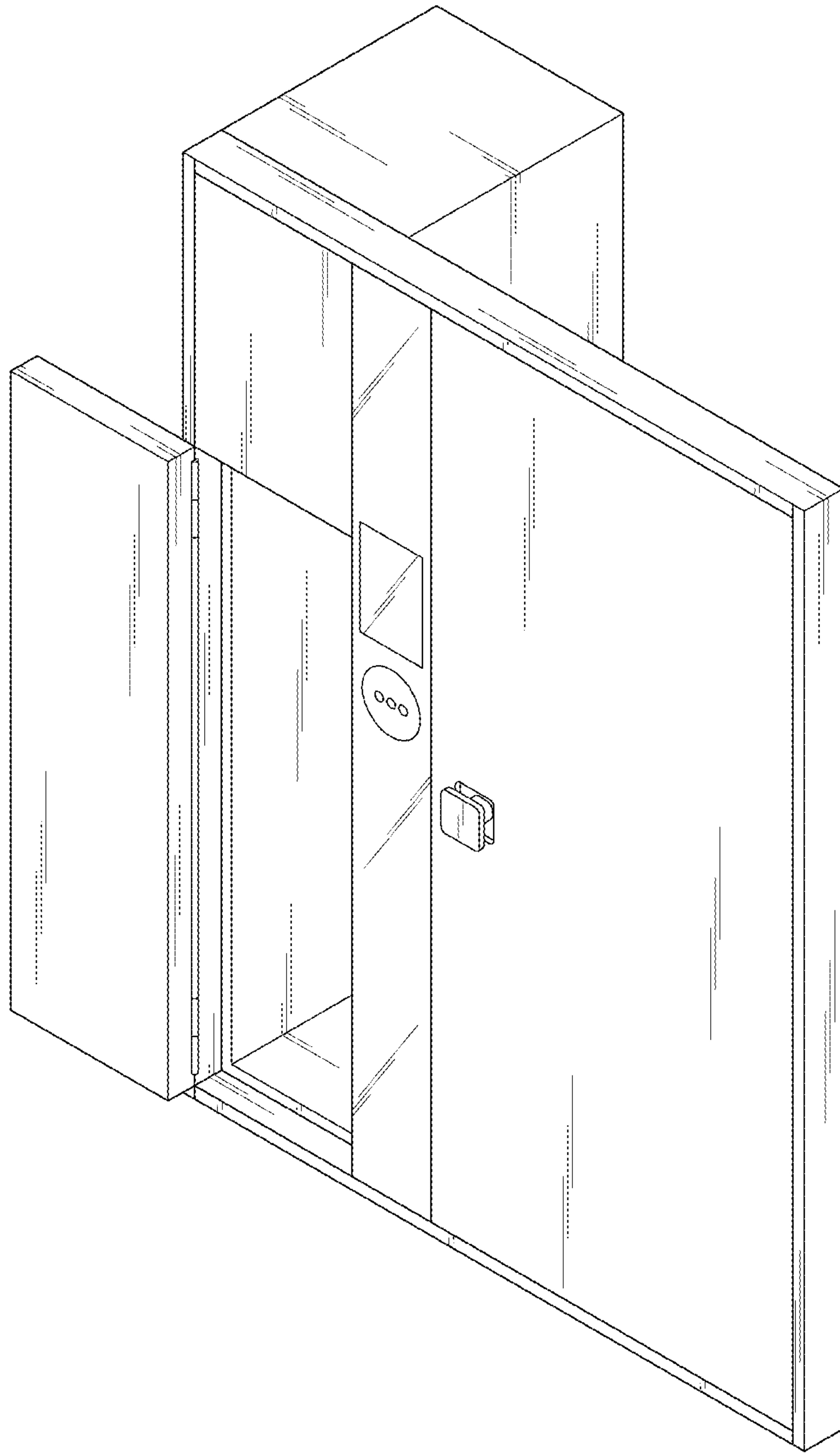




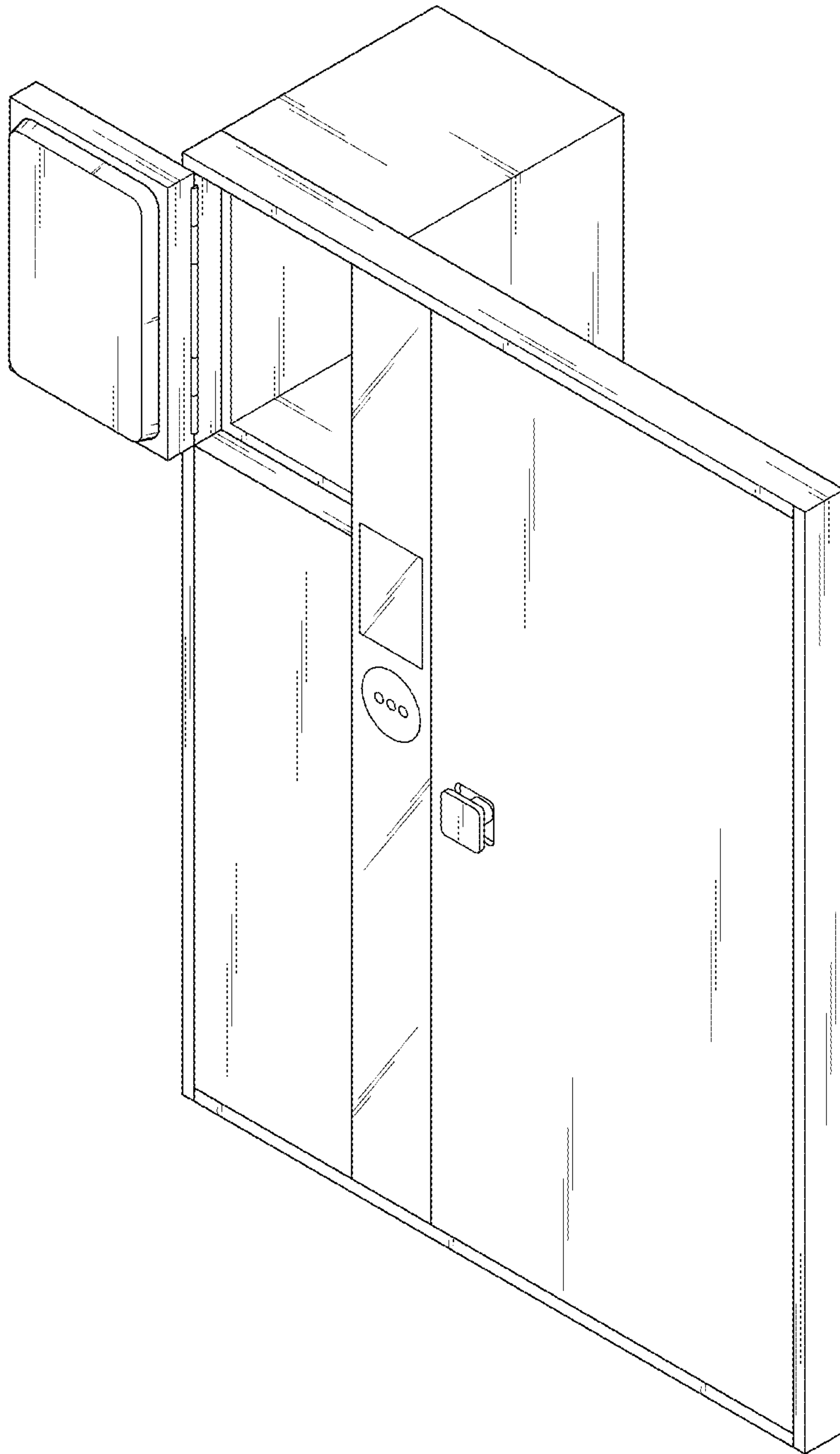
*FIG. 7*



*FIG. 8*



*FIG. 9*



*FIG. 10*

