

US00D969122S

(12) **United States Design Patent** (10) **Patent No.:** **US D969,122 S**
Pan (45) **Date of Patent:** **** Nov. 8, 2022**

(54) **MOBILE PHONE STAND**
(71) Applicant: **DONGGUAN RUNBONE TECHNOLOGY CO., LTD**, Dongguan (CN)
(72) Inventor: **Zhi Pan**, Shenzhen (CN)
(73) Assignee: **DONGGUAN RUNBONE TECHNOLOGY CO., LTD**, Dongguan (CN)

(**) Term: **15 Years**

(21) Appl. No.: **29/796,118**

(22) Filed: **Jun. 22, 2021**

(30) **Foreign Application Priority Data**

Dec. 22, 2020 (EM) 008362107-0001

(51) **LOC (13) Cl.** **14-03**

(52) **U.S. Cl.**
USPC **D14/253**

(58) **Field of Classification Search**
USPC D14/251-253, 447, 217, 250, 440;
D3/218; D12/415; D13/108
CPC A45C 2011/002; A45F 2200/0516; H04B
2001/3861; H04M 1/04
See application file for complete search history.

(56) **References Cited**

U.S. PATENT DOCUMENTS

- D770,171 S * 11/2016 Lai D3/218
- D773,449 S 12/2016 Mellano et al.
- D863,290 S * 10/2019 Ormsbee D14/253
- D864,187 S * 10/2019 Vogel D14/253
- D881,869 S * 4/2020 Pan D12/114
- D892,787 S 8/2020 Chen
- D897,332 S * 9/2020 Zhang D3/218

- D897,333 S * 9/2020 Liao D14/253
- D925,214 S * 7/2021 Jiao D3/218
- D926,466 S * 8/2021 Eremita D3/218
- D931,269 S * 9/2021 Lee D14/250
- D945,411 S * 3/2022 Jankura D16/244
- D946,565 S * 3/2022 Liu D3/218
- D947,168 S * 3/2022 Jiao D14/253
- D947,169 S * 3/2022 Jiao D14/253
- D959,419 S * 8/2022 Cheng D16/242
- D960,144 S * 8/2022 Yuan D14/253
- D961,574 S * 8/2022 Gao D14/253
- 2014/0360893 A1 * 12/2014 Whitten F16M 11/041
206/37

(Continued)

Primary Examiner — Janice Hallmark

(57) **CLAIM**

The ornamental design for a mobile phone stand, as shown and described.

DESCRIPTION

FIG. 1 is a perspective view of a mobile phone stand showing my new design;
FIG. 2 is another perspective view thereof;
FIG. 3 is a front elevational view thereof;
FIG. 4 is a rear elevational view thereof;
FIG. 5 is a left side elevational view thereof;
FIG. 6 is a right side elevational view thereof;
FIG. 7 is a top plan view thereof;
FIG. 8 is a bottom plan view thereof;
FIG. 9 is a perspective view of a mobile phone stand where the mobile phone stand is in a first configuration of use; and, FIG. 10 is a perspective view of the mobile phone stand where the mobile phone stand is in a second configuration of use.

The broken lines in the drawings depict portions of the mobile phone stand that form no part of the claimed design. The other broken lines in FIG. 9 and FIG. 10 depict environment that form no part of the claimed design.

1 Claim, 10 Drawing Sheets

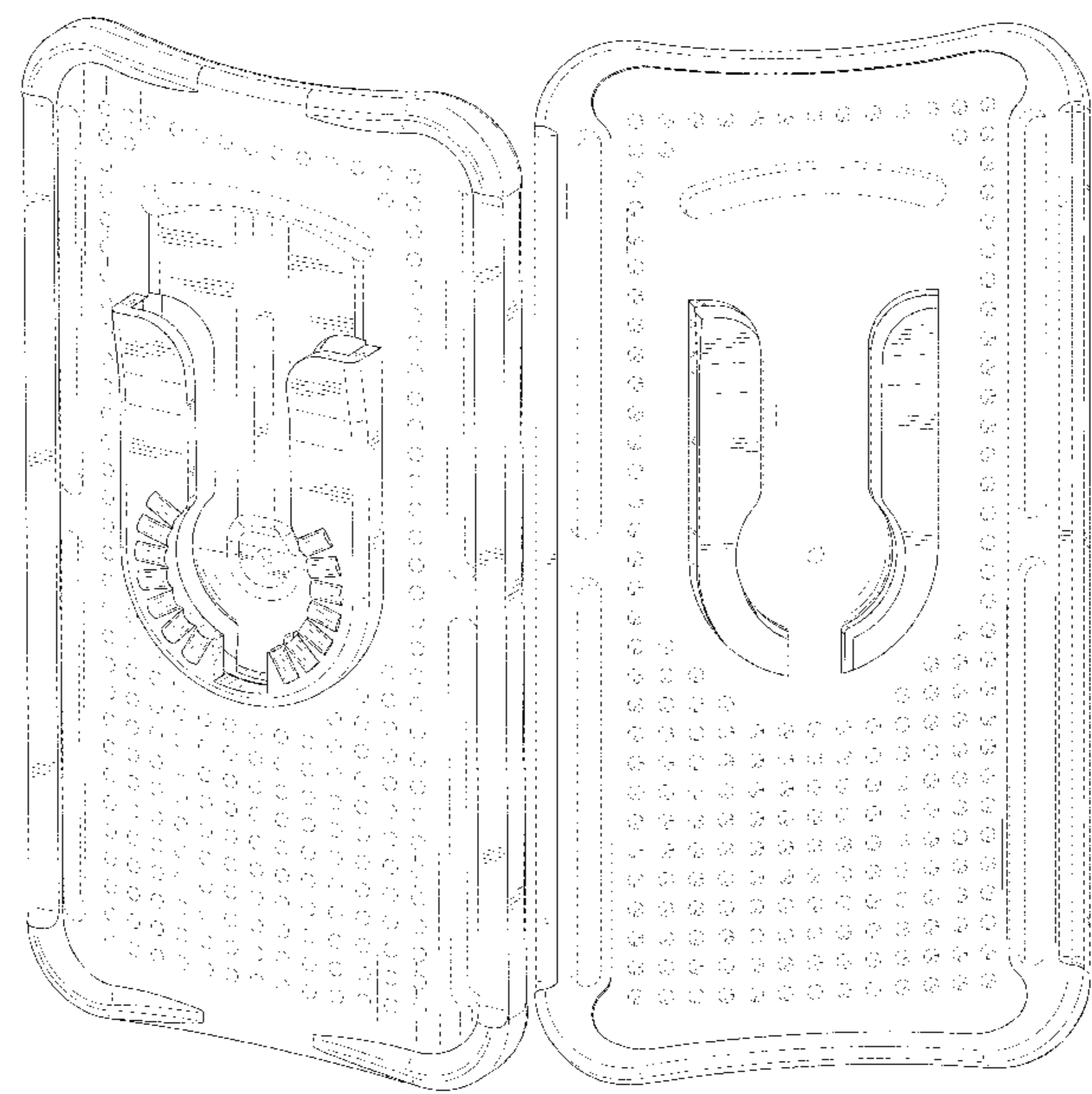

(56)

References Cited

U.S. PATENT DOCUMENTS

2015/0201723 A1* 7/2015 Rayner F16M 13/00
224/191

* cited by examiner

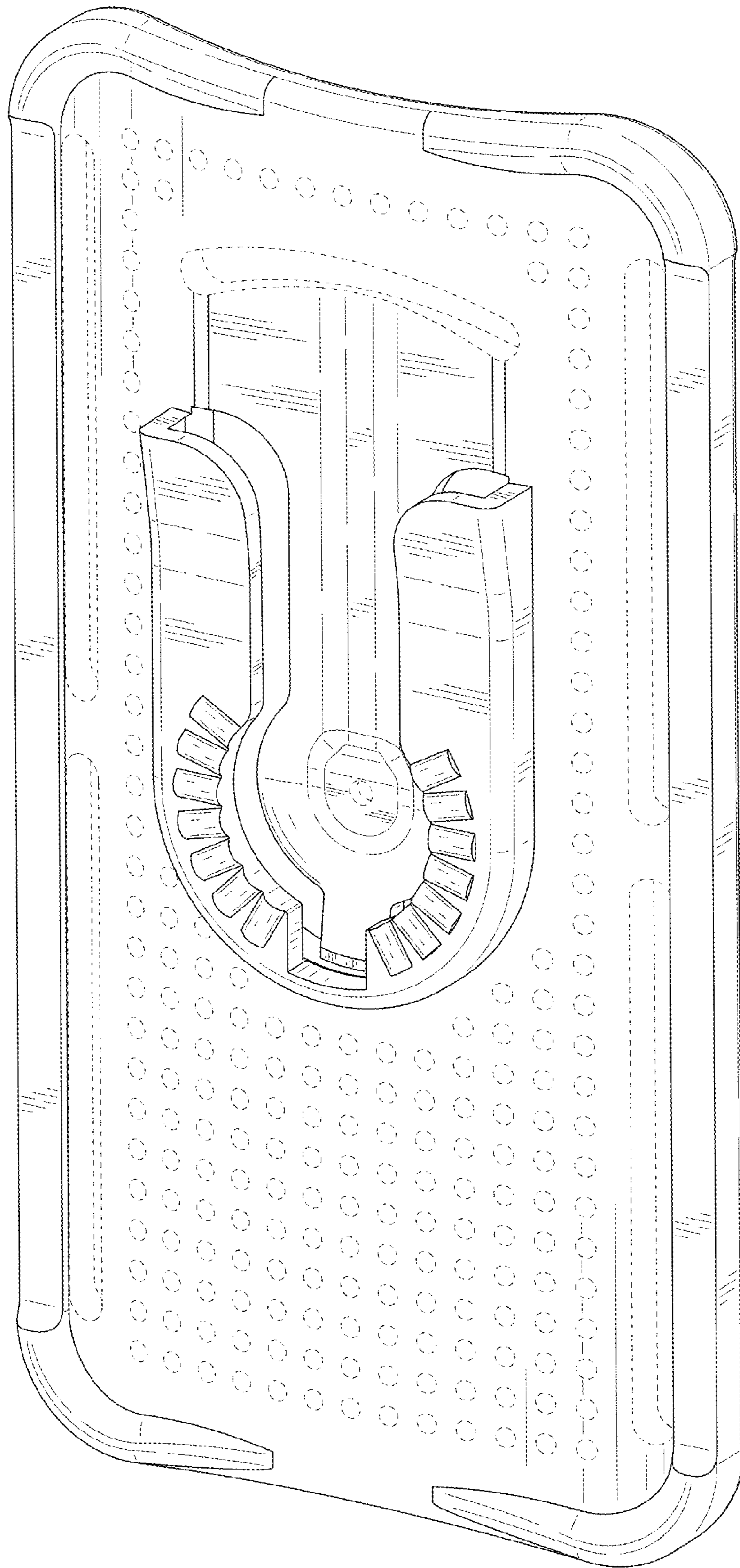

FIG. 1

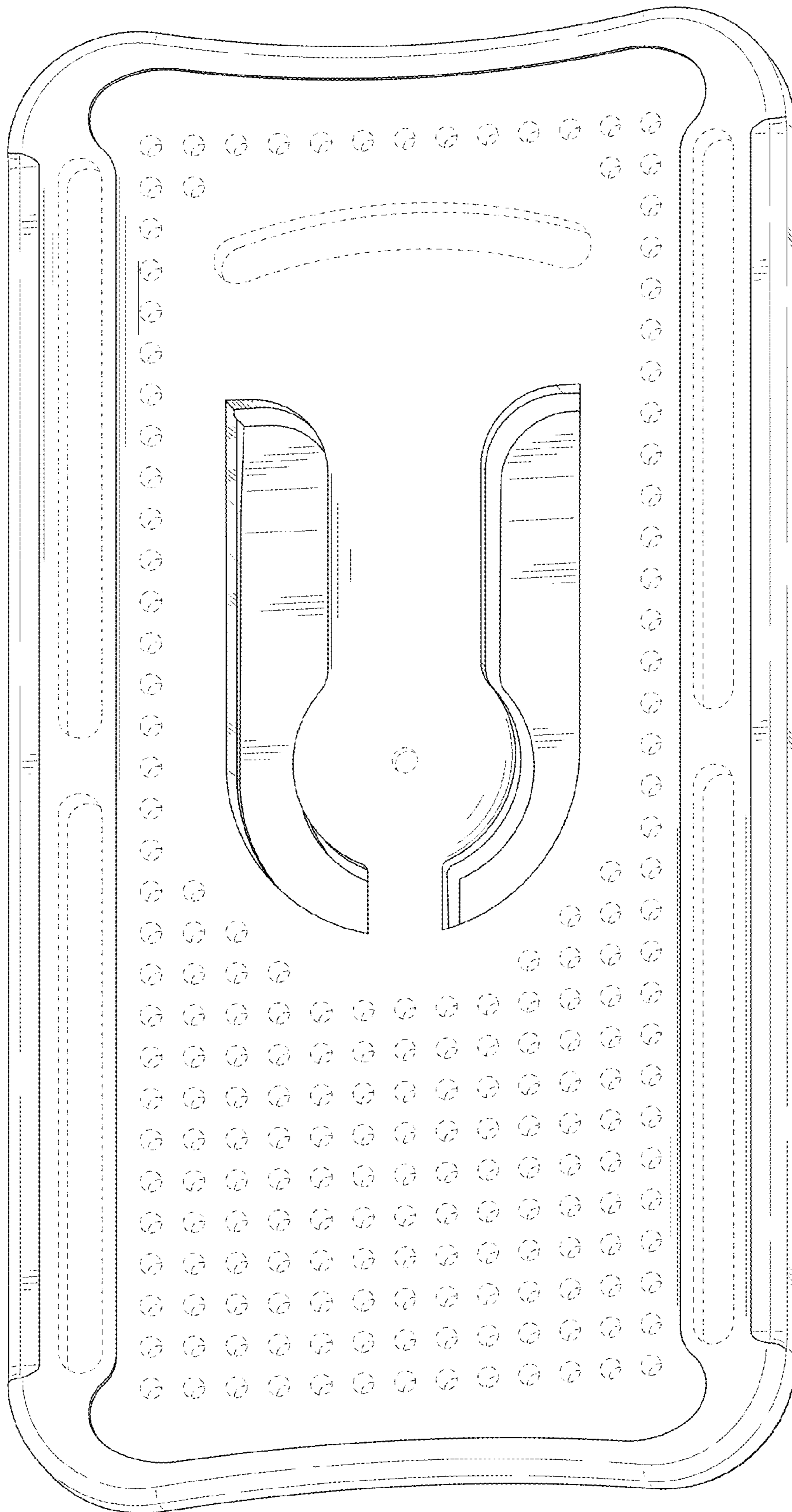

FIG. 2

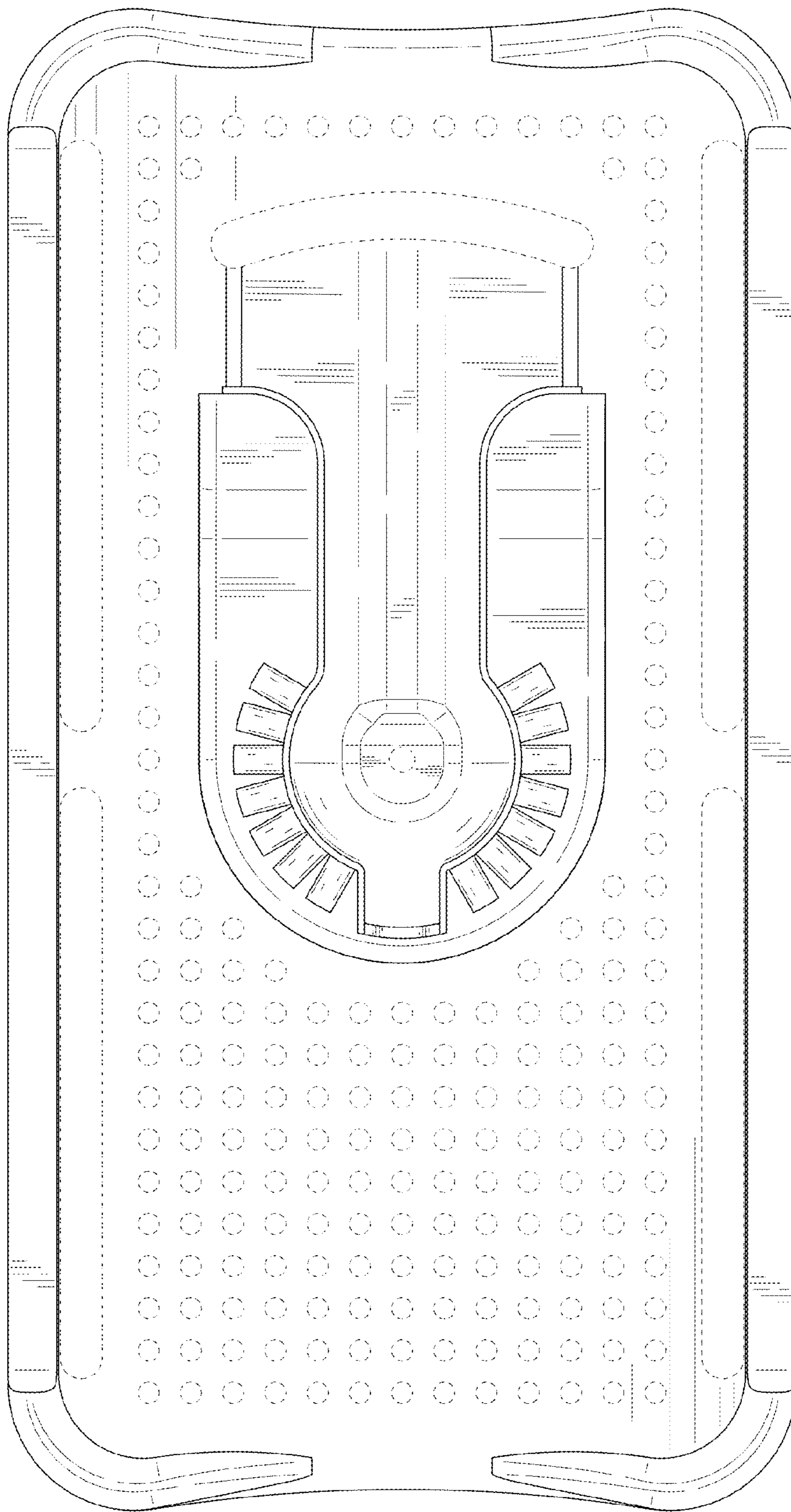

FIG. 3

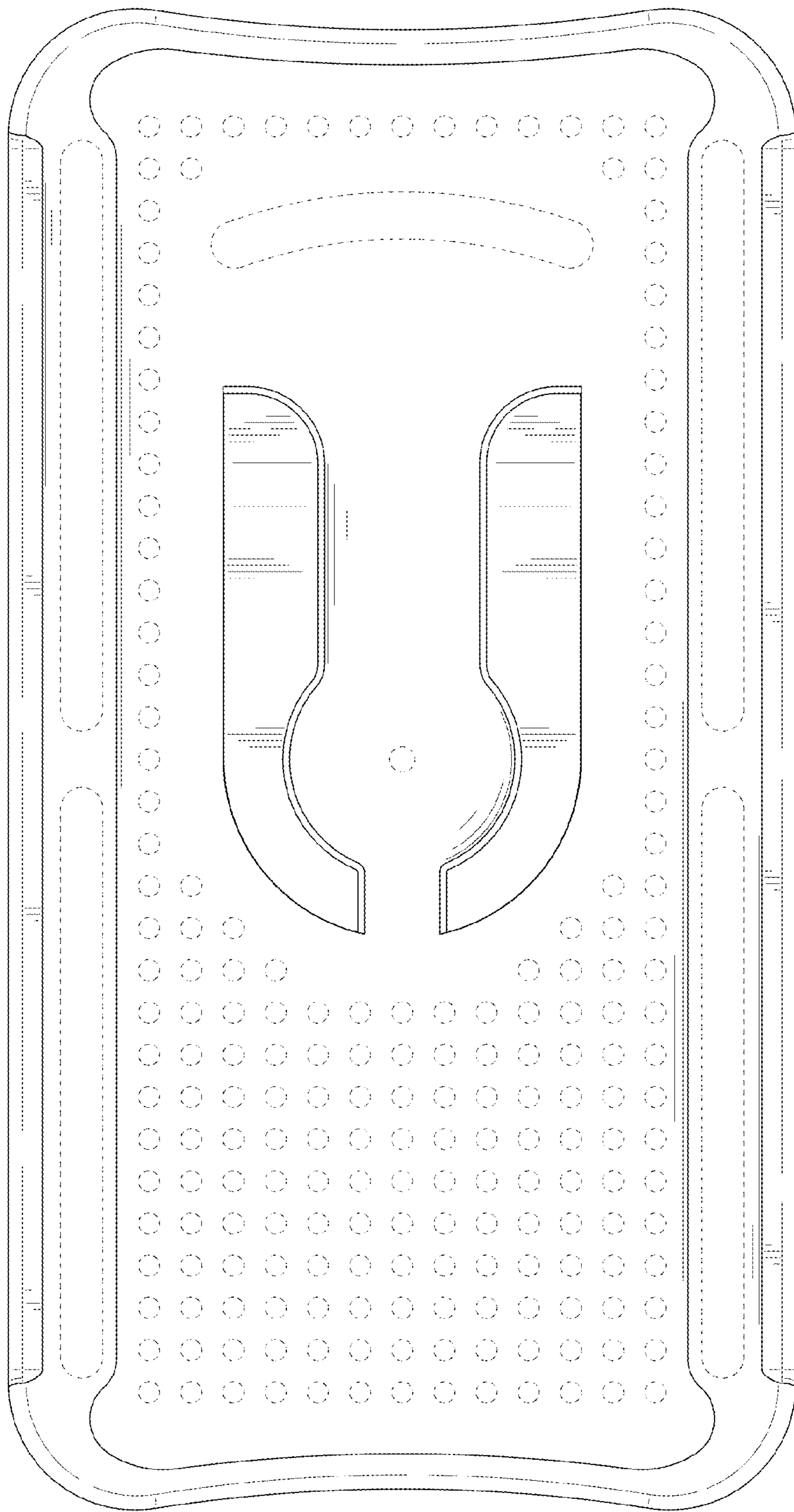

FIG. 4

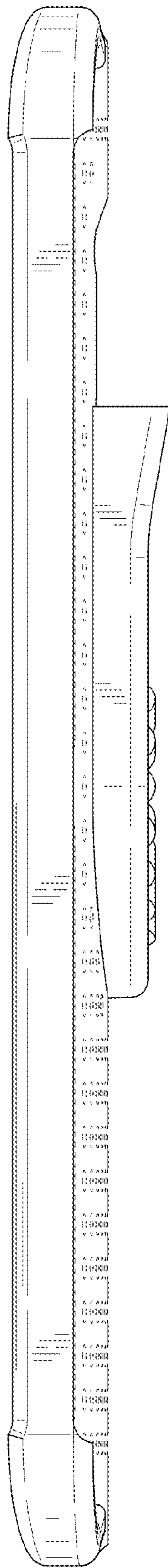

FIG. 5

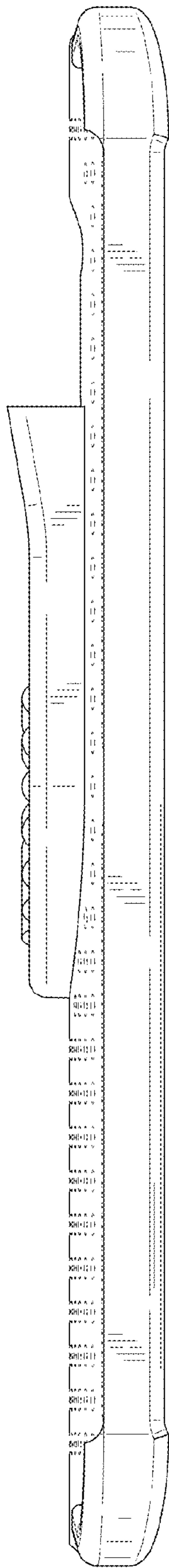

FIG. 6

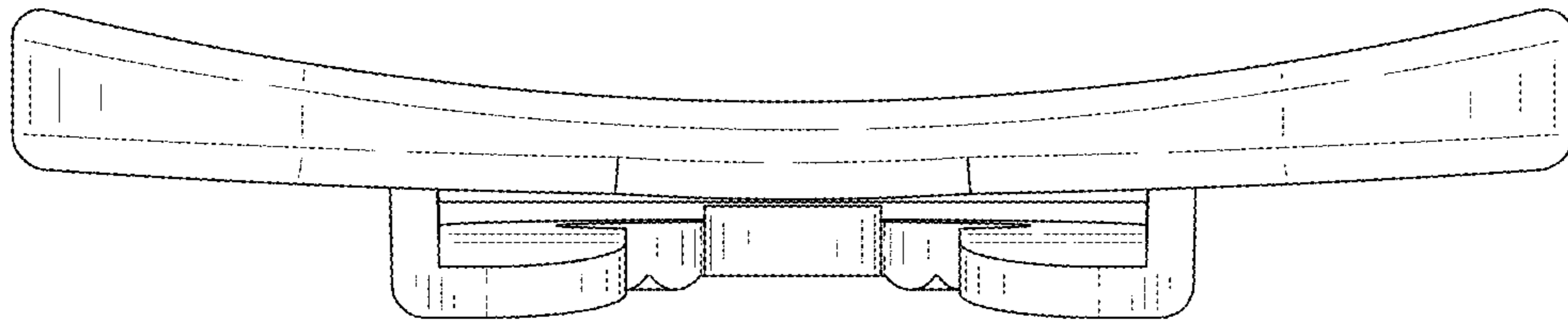

FIG. 7

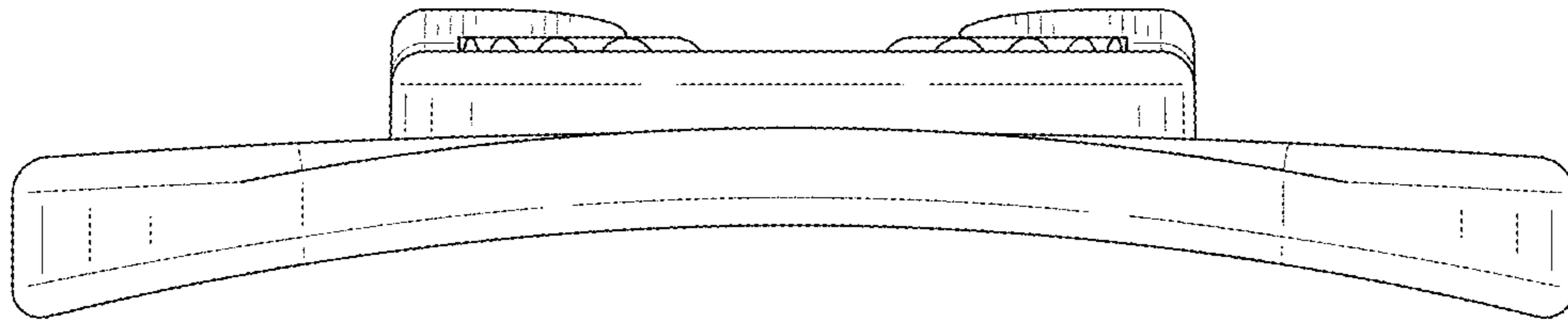

FIG. 8

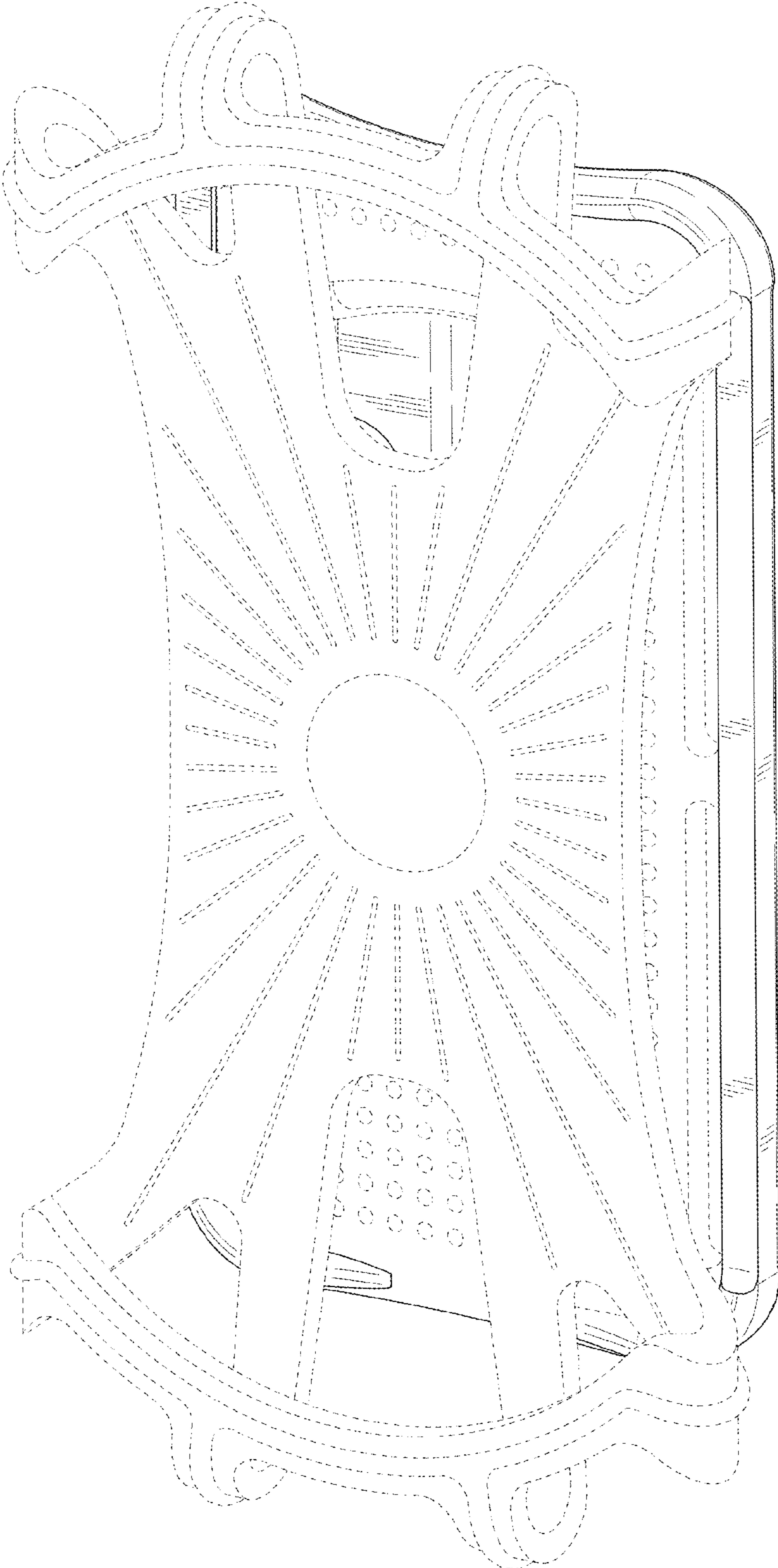

FIG. 9

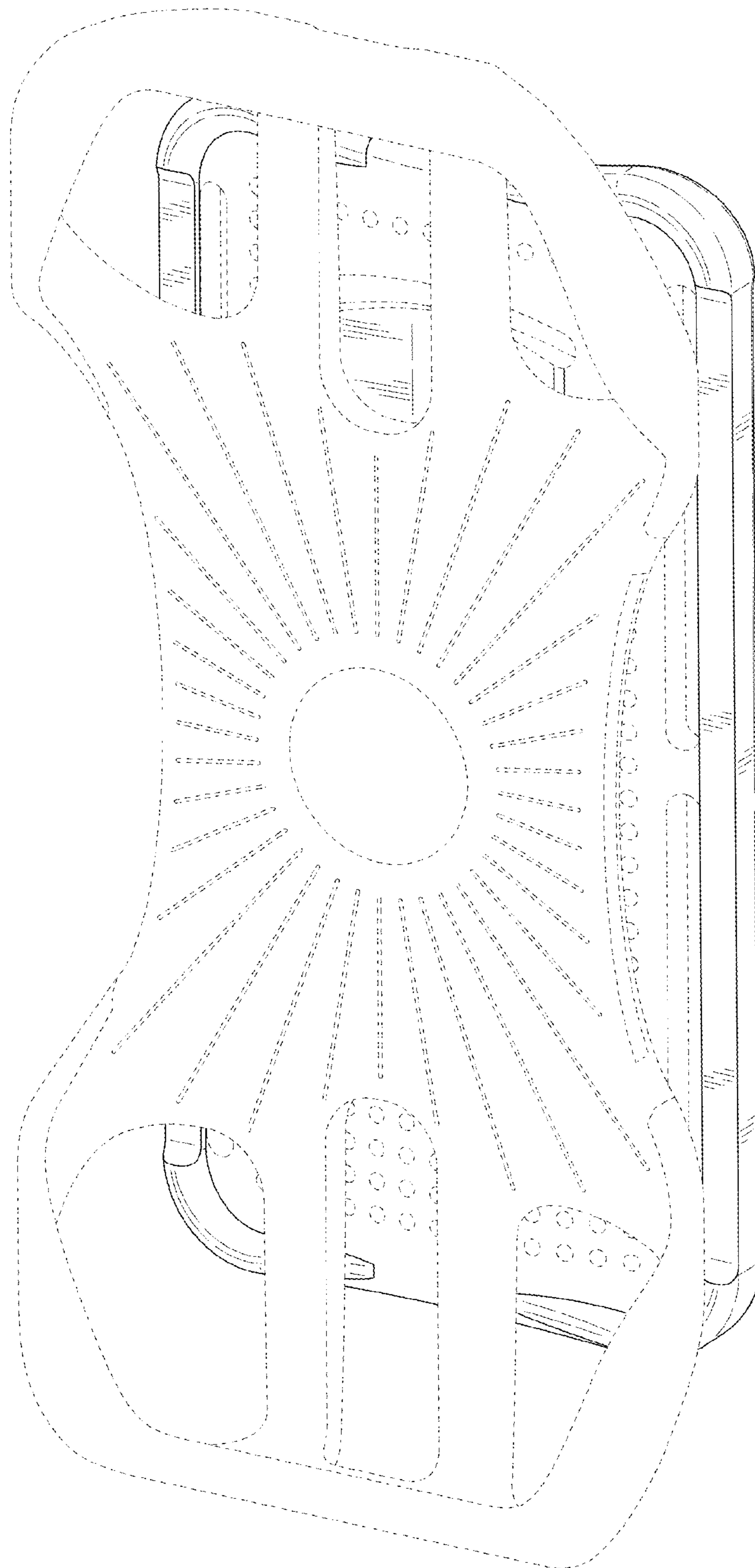

FIG. 10