

US00D969058S

(12) **United States Design Patent** (10) **Patent No.:** **US D969,058 S**
Voss (45) **Date of Patent:** **** Nov. 8, 2022**

(54) **CANOPY FOR A VEHICLE, TRUCK, LIGHT DELIVERY VEHICLE OR SIMILAR VEHICLE**

(71) Applicant: **Rock Solid Industries International (Pty) Ltd**, Pietermaritzburgh (ZA)

(72) Inventor: **Michael Voss**, Pinetown (ZA)

(73) Assignee: **ROCK SOLID INDUSTRIES INTERNATIONAL (PTY) LTD**, Pietermaritzburgh (ZA)

(**) Term: **15 Years**

(21) Appl. No.: **29/738,788**

(22) Filed: **Jun. 19, 2020**

(51) **LOC (13) Cl.** **12-16**

(52) **U.S. Cl.**
USPC **D12/404**

(58) **Field of Classification Search**
USPC D12/401-405, 181; D6/610, 611, D6/601-603, 615, 617, 621; D7/332, D7/334-337

CPC ... B60J 7/19; B60J 7/0435; B60J 7/024; B60J 11/04; B60J 1/2091; B60J 7/11; E04H 15/08

See application file for complete search history.

(56) **References Cited**

U.S. PATENT DOCUMENTS

D610,067 S *	2/2010	Frankham	D12/404
D619,078 S *	7/2010	Frankham	D12/404
D623,583 S *	9/2010	Girardi	D12/404
D812,545 S *	3/2018	Donohoe	D12/404
D836,532 S *	12/2018	King	D12/404
D867,969 S *	11/2019	Johnson	D12/404

D928,694 S *	8/2021	Steinberg	B62D 33/0617 D12/404
D930,551 S *	9/2021	Suckling	D12/401
2008/0067830 A1 *	3/2008	Frankham	B60J 7/106 296/100.02
2010/0327618 A1 *	12/2010	Soldatelli	B60J 7/1621 296/100.1
2020/0398644 A1 *	12/2020	Voss	B60H 3/0641

OTHER PUBLICATIONS

SmartCanopy—YouTube [online] [retrieved Jun. 26, 2019]. Retrieved from the Internet: <<https://www.youtube.com/user/RockSolidIndustries1/videos>>. (undated) 3 pages.

RSI SMARTCANOPY®—Leisure Canopy—YouTube [online] [retrieved Jun. 26, 2019]. Retrieved from the Internet: <https://www.youtube.com/watch?v=Rrt_o41CQI>. (dated Mar. 7, 2017) 1 page.

(Continued)

Primary Examiner — Katrina A Betton

(74) *Attorney, Agent, or Firm* — K&L Gates LLP; Nolan R. Hubbard

(57) **CLAIM**

I claim the ornamental design for a canopy for a vehicle, truck, light delivery vehicle or similar vehicle, as shown and described.

DESCRIPTION

FIG. 1 is left side elevation view of a canopy for a vehicle, truck, light delivery vehicle or similar vehicle, showing my new design;

FIG. 2 is a right side elevation view thereof;

FIG. 3 is a front elevation view thereof;

FIG. 4 is a rear elevation view thereof;

FIG. 5 is a top plan view thereof;

FIG. 6 is a bottom plan view thereof;

FIG. 7 is a rear perspective view thereof; and,

FIG. 8 is a front perspective view thereof.

1 Claim, 8 Drawing Sheets

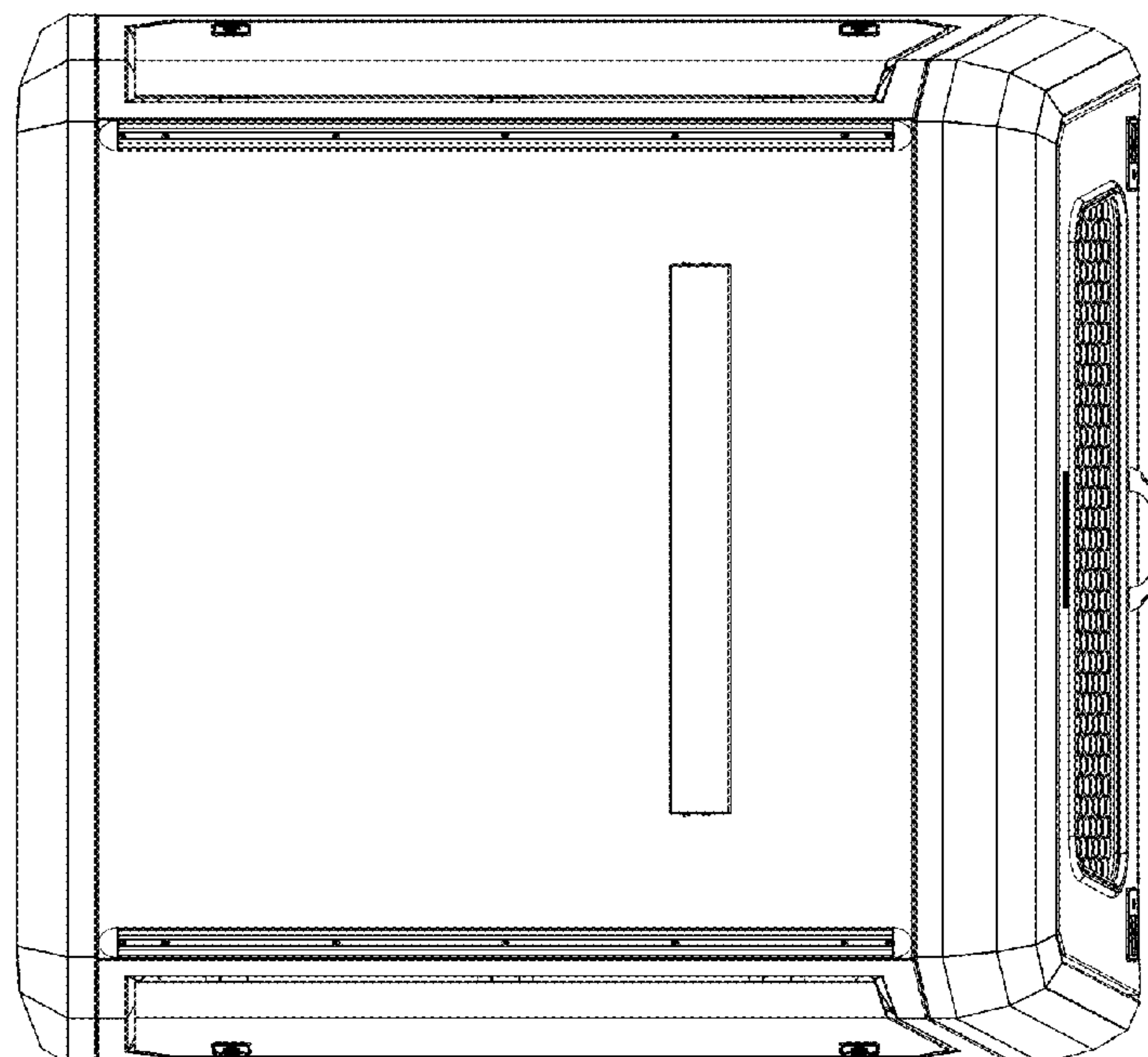

(56)

References Cited

OTHER PUBLICATIONS

Leisure RSI SmartCanopy (Short Clip)—YouTube [online] [retrieved Jun. 26, 2019]. Retrieved from the Internet: <https://www.youtube.com/watch?v=_b2jhIw032E>. (dated Jun. 14, 2017) 1 page.

RSi SMARTCANOPY® Stainless Steel Canopies & Accessories, 2018 Edition [online] [retrieved Jun. 26, 2019]. Retrieved from the Internet: <[https://smartcanopy.co.za/PDF/RSI-SMARTCANOPY-Brochure-April-2018-\(WEB\).pdf](https://smartcanopy.co.za/PDF/RSI-SMARTCANOPY-Brochure-April-2018-(WEB).pdf)>. (Apr. 2018) 8 pages.

RSi SMARTCANOPY® Less Standard, More Smart [online] [retrieved Jun. 26, 2019]. Retrieved from the Internet: <[https://smartcanopy.co.za/PDF/RSI-SMARTCANOPY-Sales-Brochure-2017-\(WEB\).pdf](https://smartcanopy.co.za/PDF/RSI-SMARTCANOPY-Sales-Brochure-2017-(WEB).pdf)>. (2017) 4 pages.

Design U.S. Appl. No. 29/681,185, filed Feb. 22, 2019, In re Michael Voss, entitled *Modular Flat Deck, Skirting, And Canopy For A Vehicle, Truck, Or The Like*.

Design U.S. Appl. No. 29/681,188, filed Feb. 22, 2019, In re: Michael Voss, entitled *Canopy For A Vehicle, Truck, Or The Like*.

Design U.S. Appl. No. 29/681,255, filed Feb. 22, 2019, In re Michael Voss, entitled *Canopy For A Vehicle, Truck, Or The Like And Components And Accessories Related Thereto*.

Design U.S. Appl. No. 29/707,702, filed Sep. 30, 2019, In re Michael Voss., entitled *Panel With An Integrated Upper Window For A Vehicle Canopy*.

Design U.S. Appl. No. 29/707,698, filed Sep. 30, 2019, In re Michael Voss, entitled *Canopy For A Vehicle, Truck, Light Delivery Vehicle Or Similar Vehicle*.

Design U.S. Appl. No. 29/707,700, filed Sep. 30, 2019, In re Michael Voss, entitled *Canopy For A Vehicle, Truck, Light Delivery Vehicle Or Similar Vehicle*.

Design U.S. Appl. No. 29/707,699, filed Sep. 30, 2019, In re Michael Voss, entitled *Canopy For A Vehicle, Truck, Light Delivery Vehicle Or Similar Vehicle*.

Design U.S. Appl. No. 29/724,879, filed Feb. 20, 2020, In re Michael Voss, entitled *Canopy for a Vehicle, Truck, Light Delivery Vehicle or Similar Vehicle*.

* cited by examiner

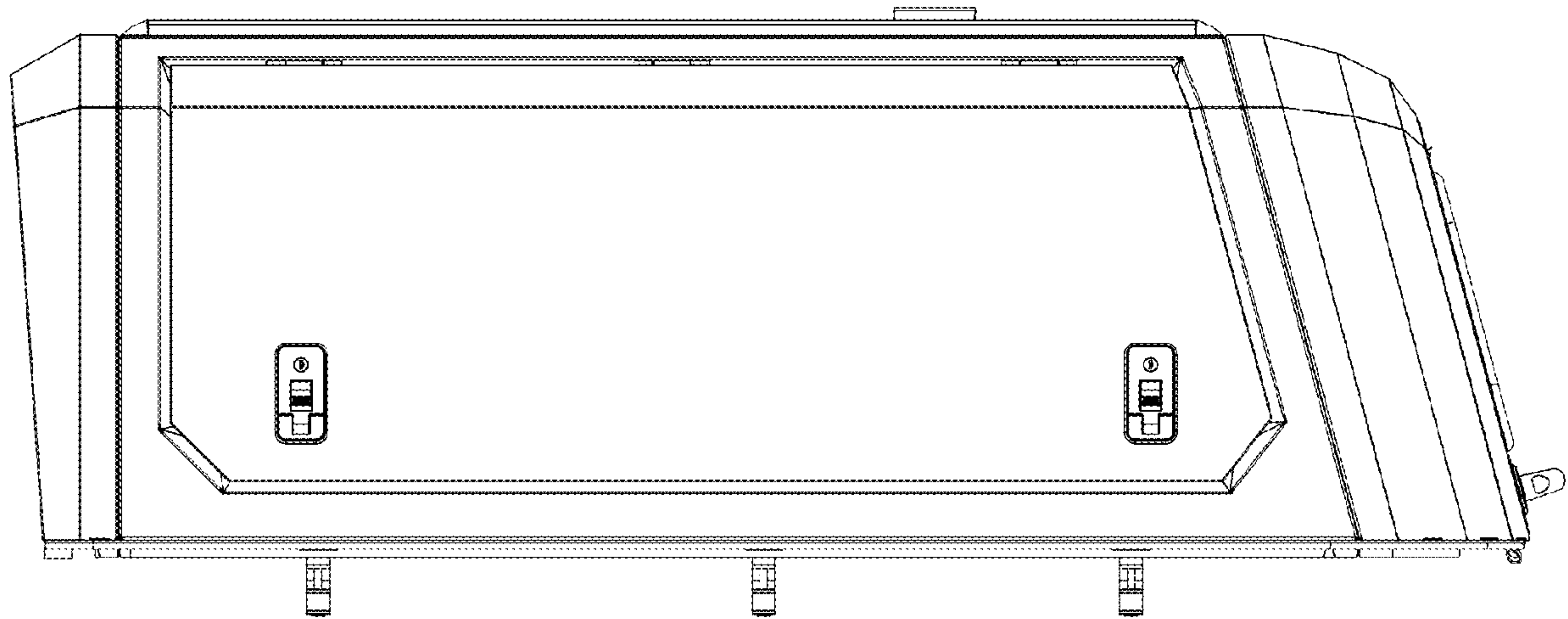

Figure 1

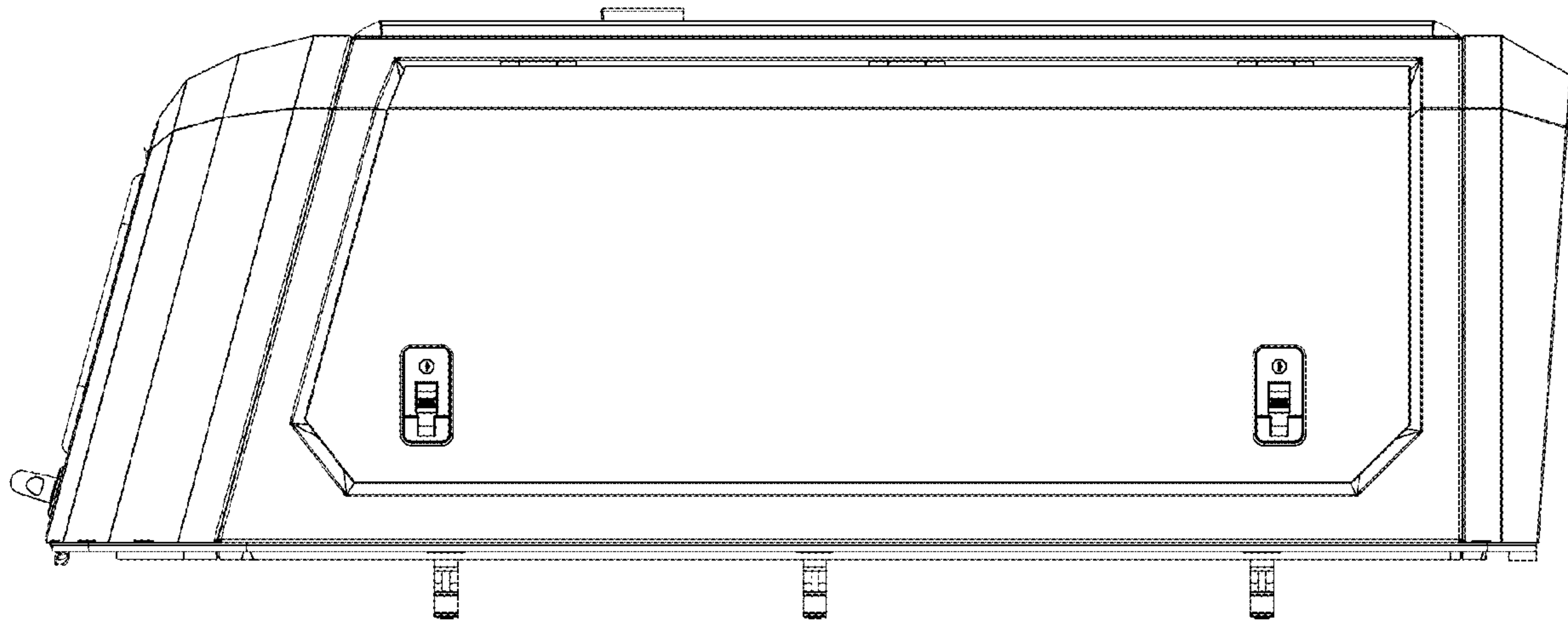

Figure 2

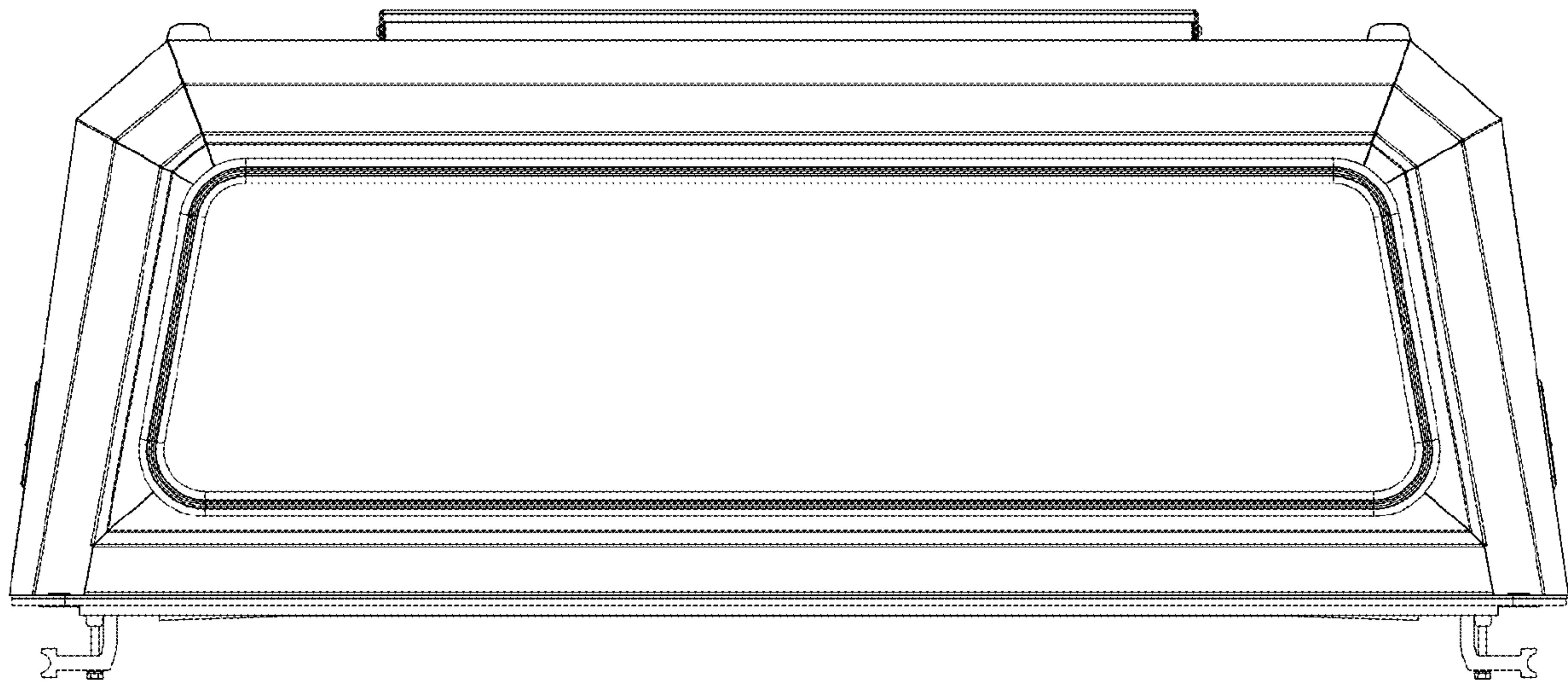

Figure 3

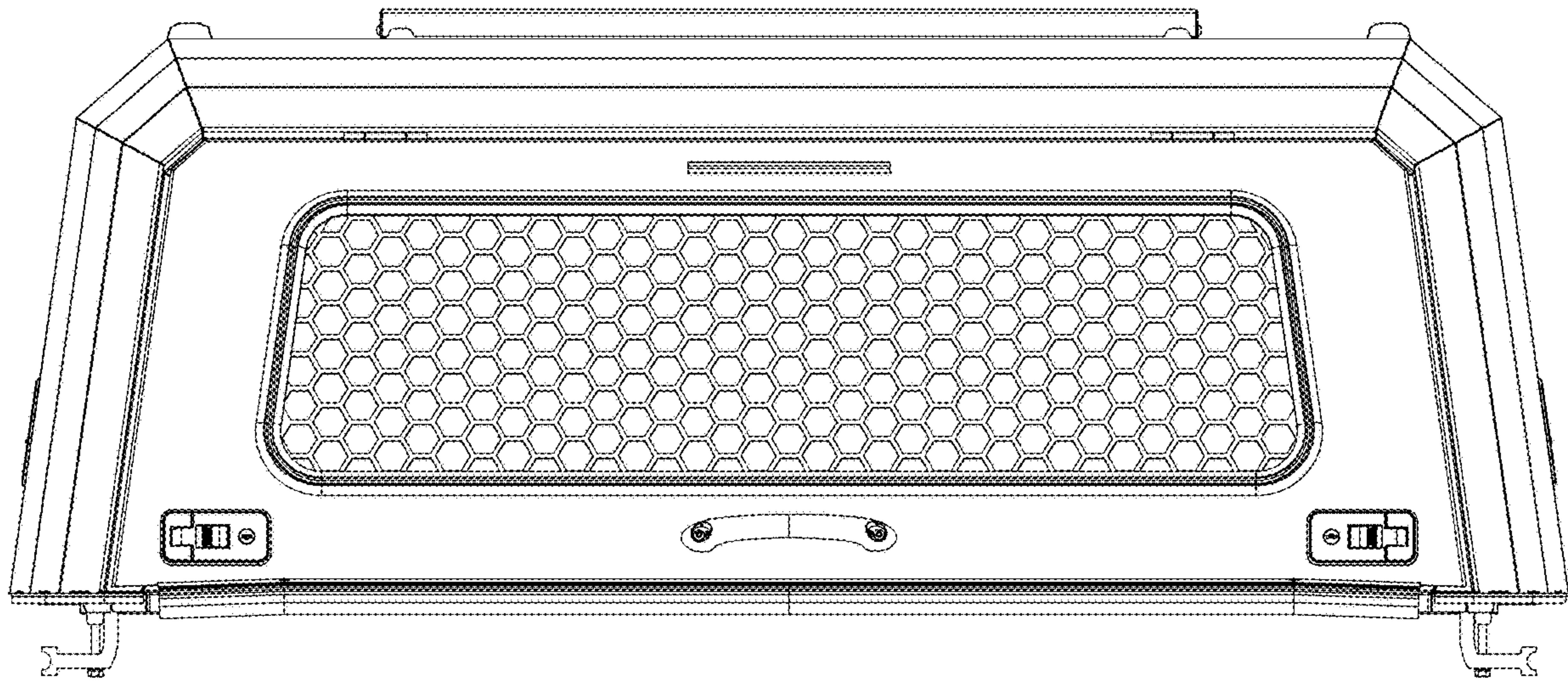

Figure 4

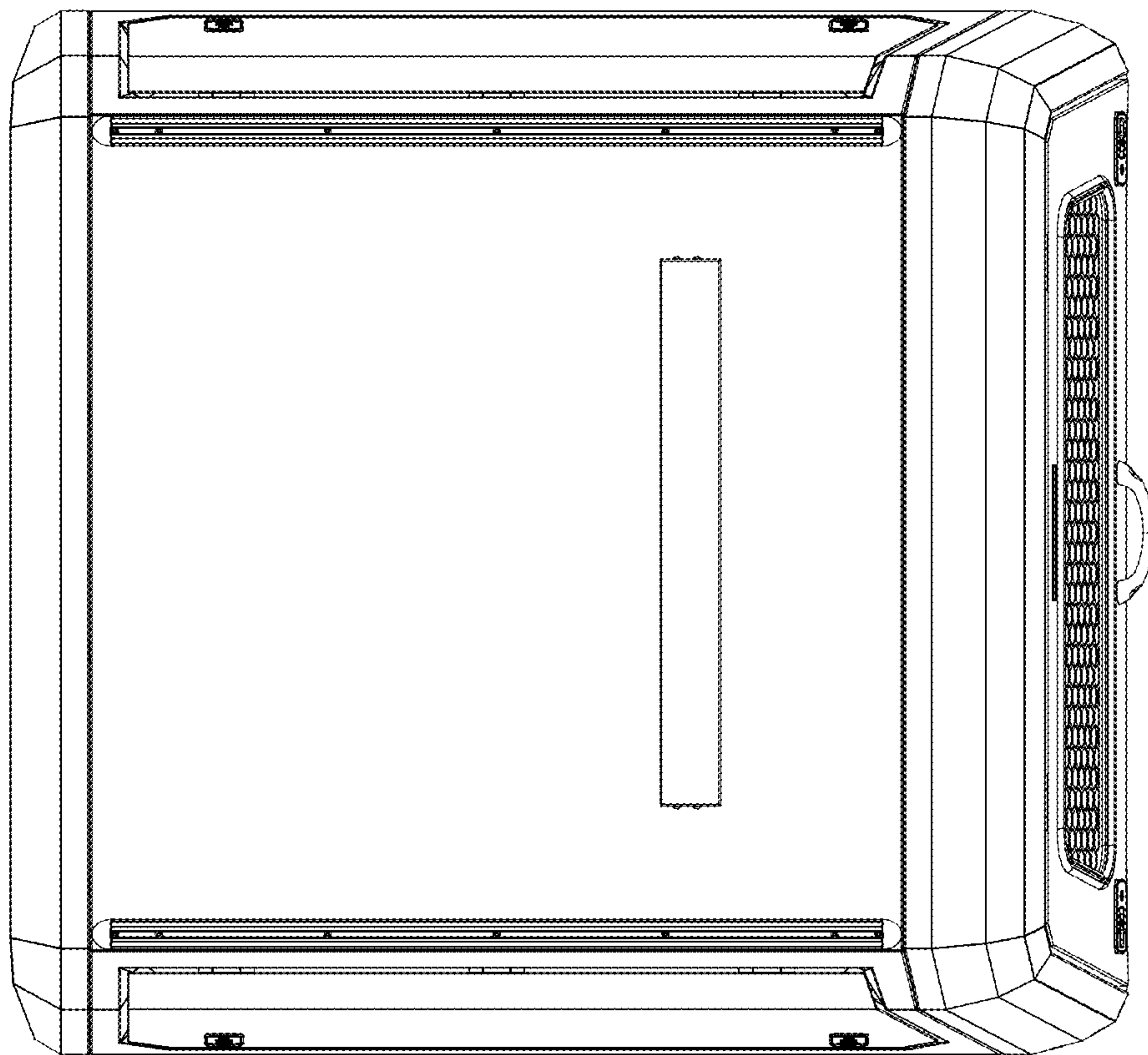

Figure 5

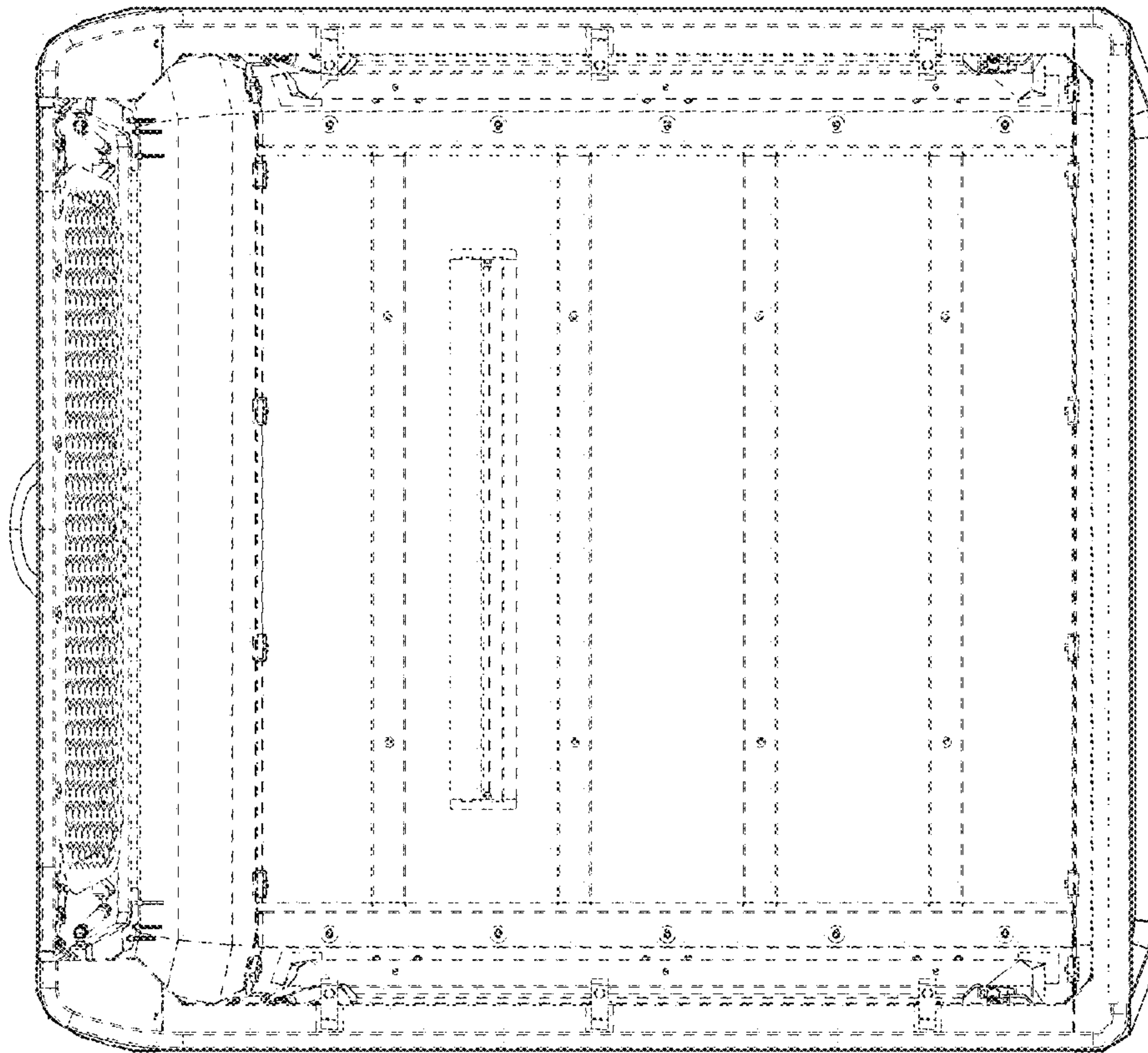

Figure 6

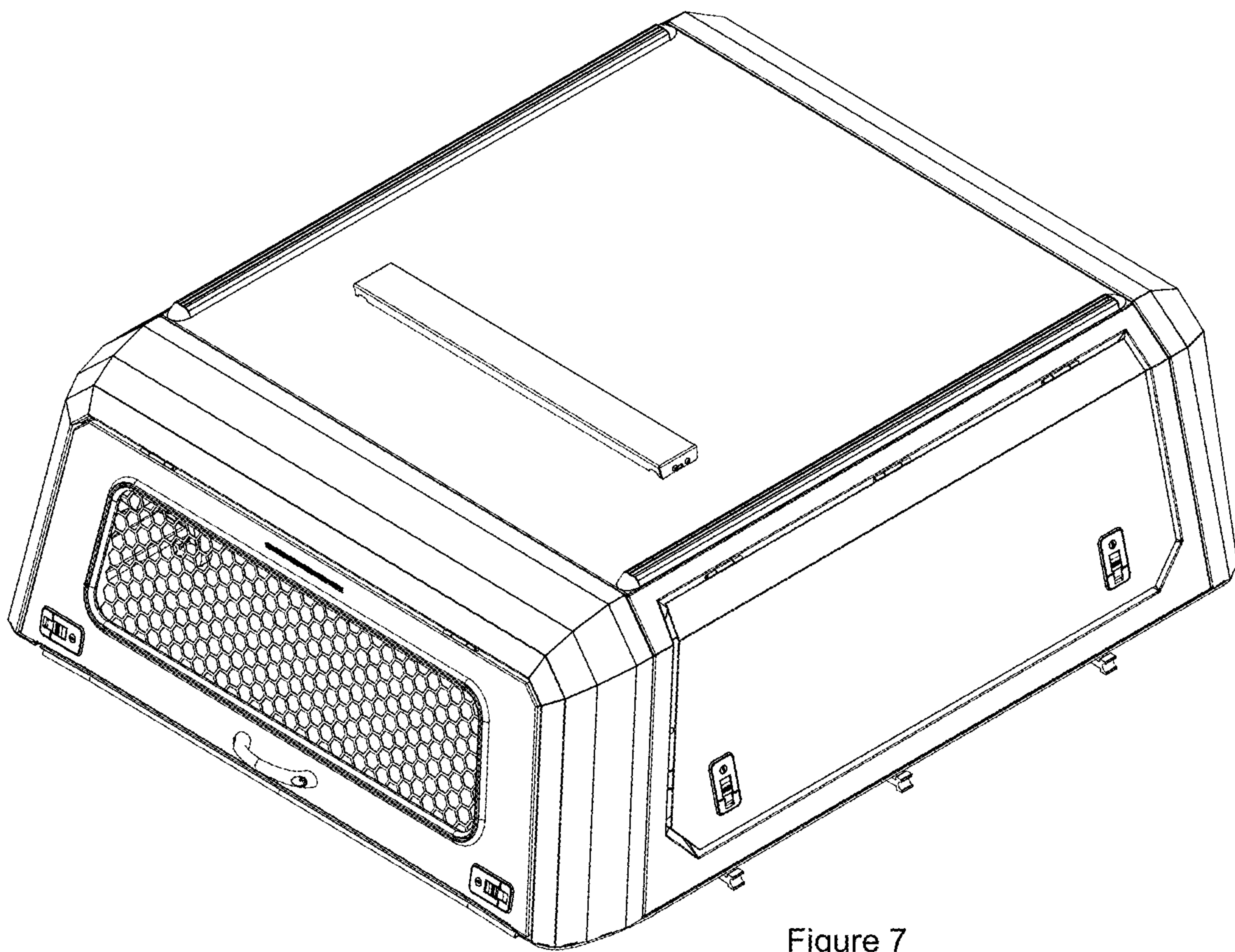

Figure 7

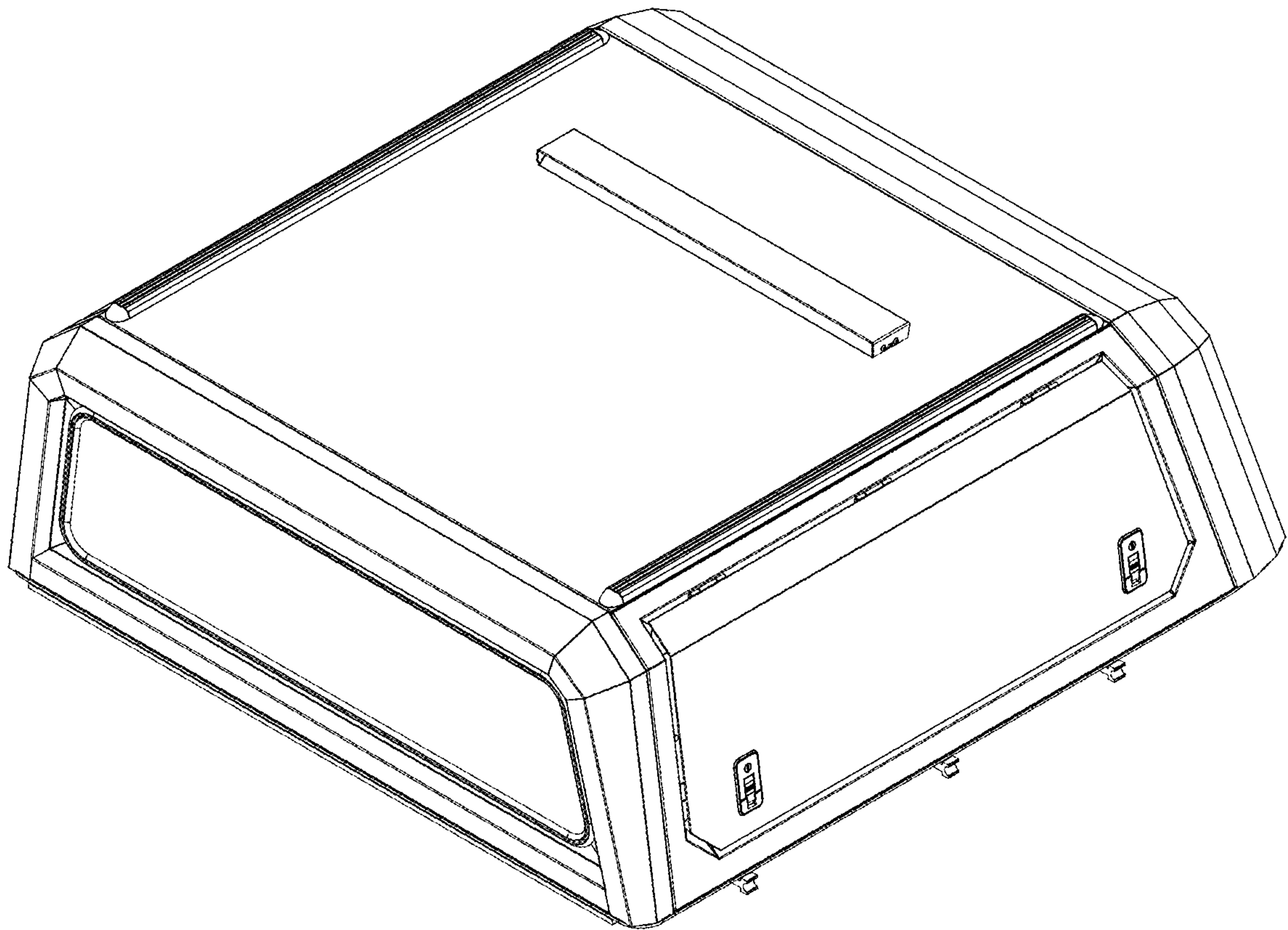

Figure 8