



US00D969056S

(12) **United States Design Patent**
Wegesin

(10) **Patent No.:** **US D969,056 S**
(45) **Date of Patent:** **** Nov. 8, 2022**

(54) **VEHICLE CONSOLE COVER**

(71) Applicant: **Lady Edison & Co. LLC**, Dublin, OH (US)
(72) Inventor: **Andrew Wegesin**, Dublin, OH (US)
(73) Assignee: **LADY EDISON & CO. LLC**, Dublin, OH (US)

(**) Term: **15 Years**

(21) Appl. No.: **29/750,568**

(22) Filed: **Sep. 15, 2020**

(51) **LOC (13) Cl.** **12-16**

(52) **U.S. Cl.**
USPC **D12/401**

(58) **Field of Classification Search**
USPC D12/400, 18, 125, 174, 179, 180, 204, D12/216, 401, 607
CPC B60R 13/10; B60B 7/12
See application file for complete search history.

(56) **References Cited**

U.S. PATENT DOCUMENTS

D572,069 S *	7/2008	McQueen	D6/611
D644,831 S *	9/2011	Smith	D3/8
D651,157 S *	12/2011	Kassouni	D12/401
D673,766 S *	1/2013	Smith	D3/8
D679,647 S *	4/2013	Tuten	D12/401
D683,665 S *	6/2013	Smith	D12/126
D692,634 S *	10/2013	Torres	D99/12
D723,327 S *	3/2015	Morgan	D7/392.1
D823,227 S *	7/2018	Sims	D12/400
2007/0017613 A1 *	1/2007	Hernandez	B60B 7/12
				150/154
2010/0200130 A1 *	8/2010	Wilson	B60R 13/10
				150/154

OTHER PUBLICATIONS

Voodonala Console Armrest Wrangler Unlimited, <https://www.amazon.com/Voodonala-Console-Armrest-Wrangler-Unlimited/dp/B07KR1ML1M>, Retrieved on May 14, 2021 (8 pages).

* cited by examiner

Primary Examiner — Susan E Krakower

Assistant Examiner — Jerry Shiuan-Hua Hsu

(74) *Attorney, Agent, or Firm* — Ulmer & Berne LLP

(57) **CLAIM**

The ornamental design for a vehicle console cover, as shown and described.

DESCRIPTION

FIG. 1 is a front perspective view of a vehicle console cover showing the new design;
FIG. 2 is a front elevation view thereof;
FIG. 3 is a rear elevation view thereof;
FIG. 4 is a right side elevation view thereof;
FIG. 5 is a left side elevation view thereof;
FIG. 6 is a top plan view thereof;
FIG. 7 is a bottom plan view thereof; and,
FIG. 8 is a front perspective environmental view thereof.
The shorter broken lines present in FIGS. 2, 3, and 7 illustrate portions of the interior surface of the vehicle console cover which form no part of the claimed design. The longer broken lines present in FIGS. 1-8 illustrate stitching on the exterior surface of the vehicle console cover which forms no part of the claimed design. The shorter broken lines present in FIG. 8 depict a center console which forms no part of the claimed design.

1 Claim, 7 Drawing Sheets

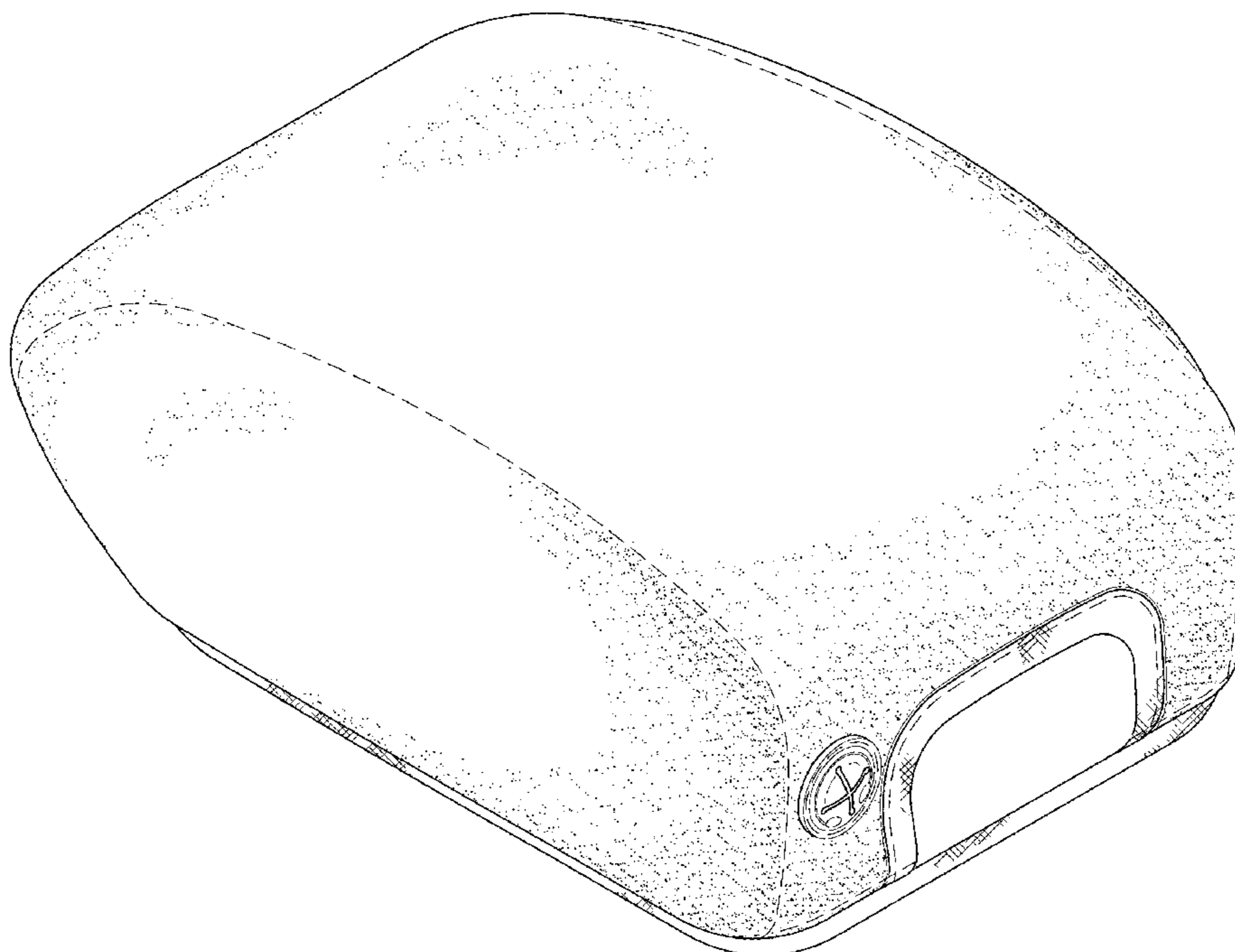

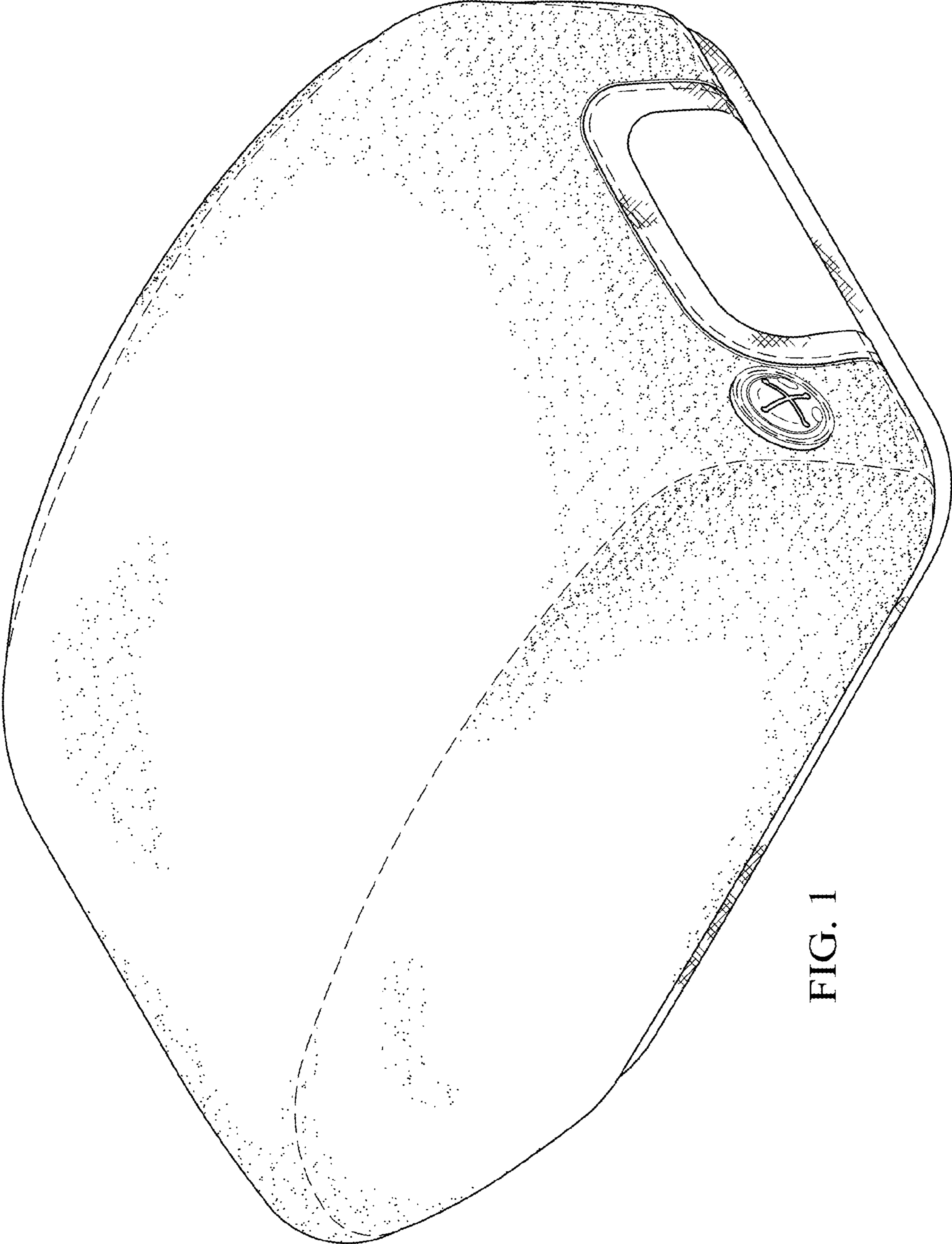

FIG. 1

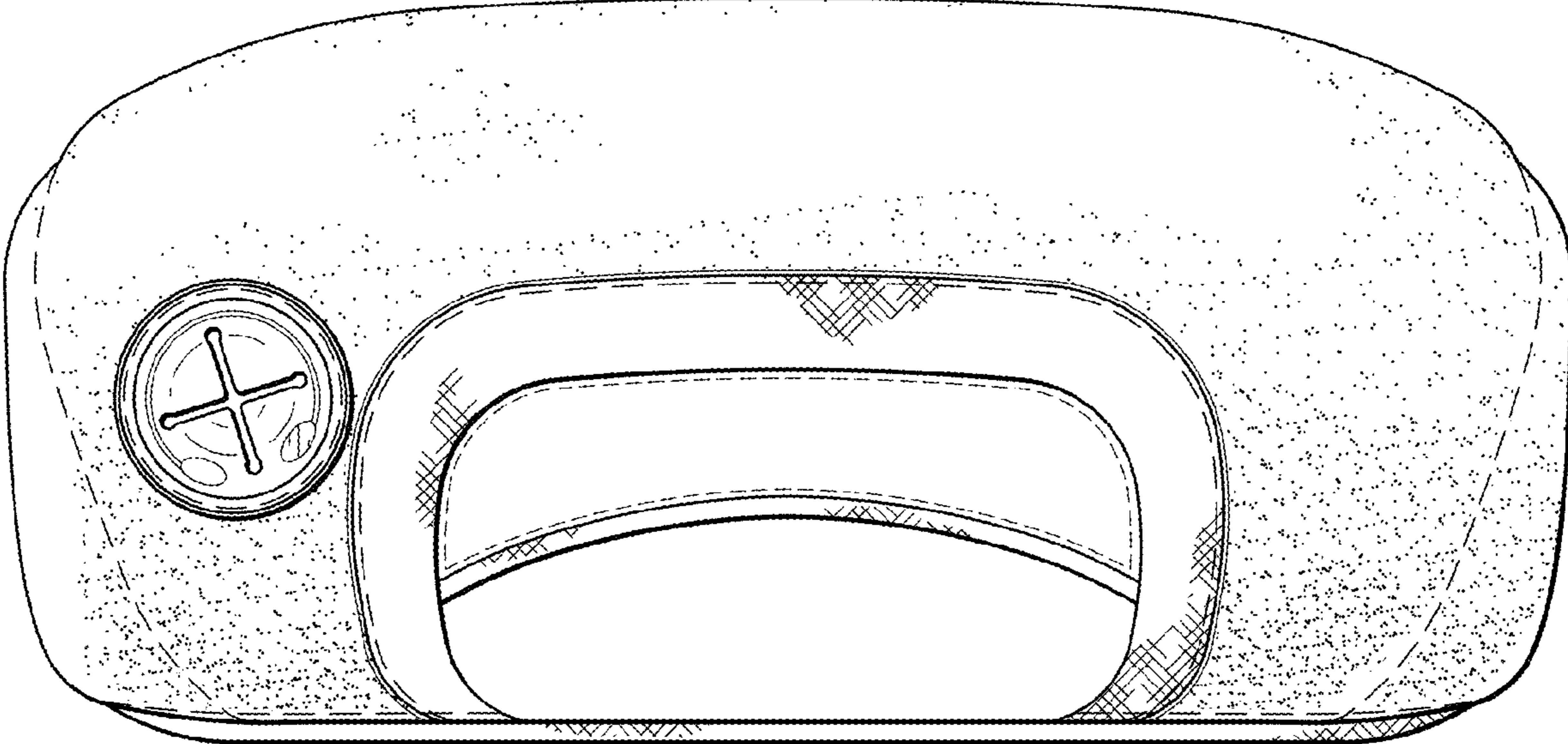

FIG. 2

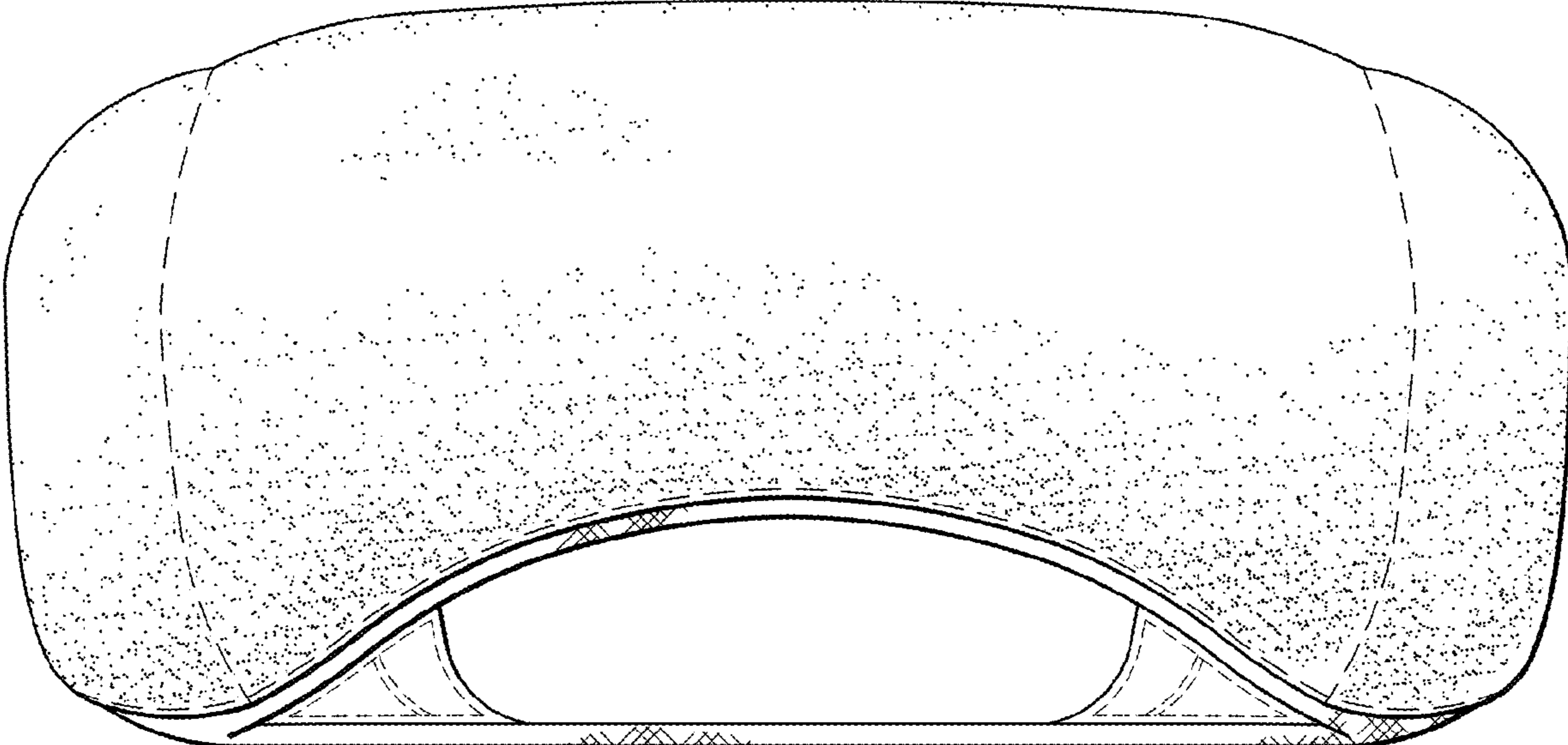

FIG. 3

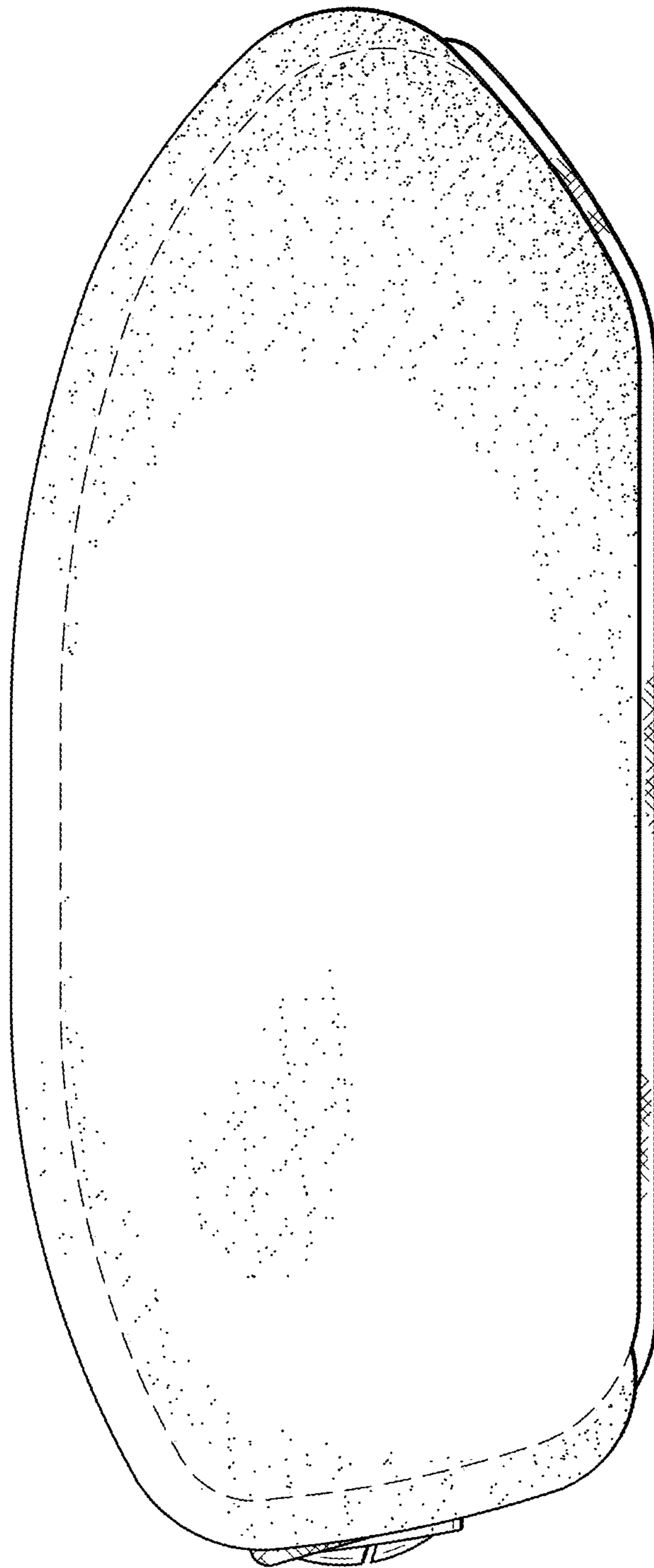

FIG. 4

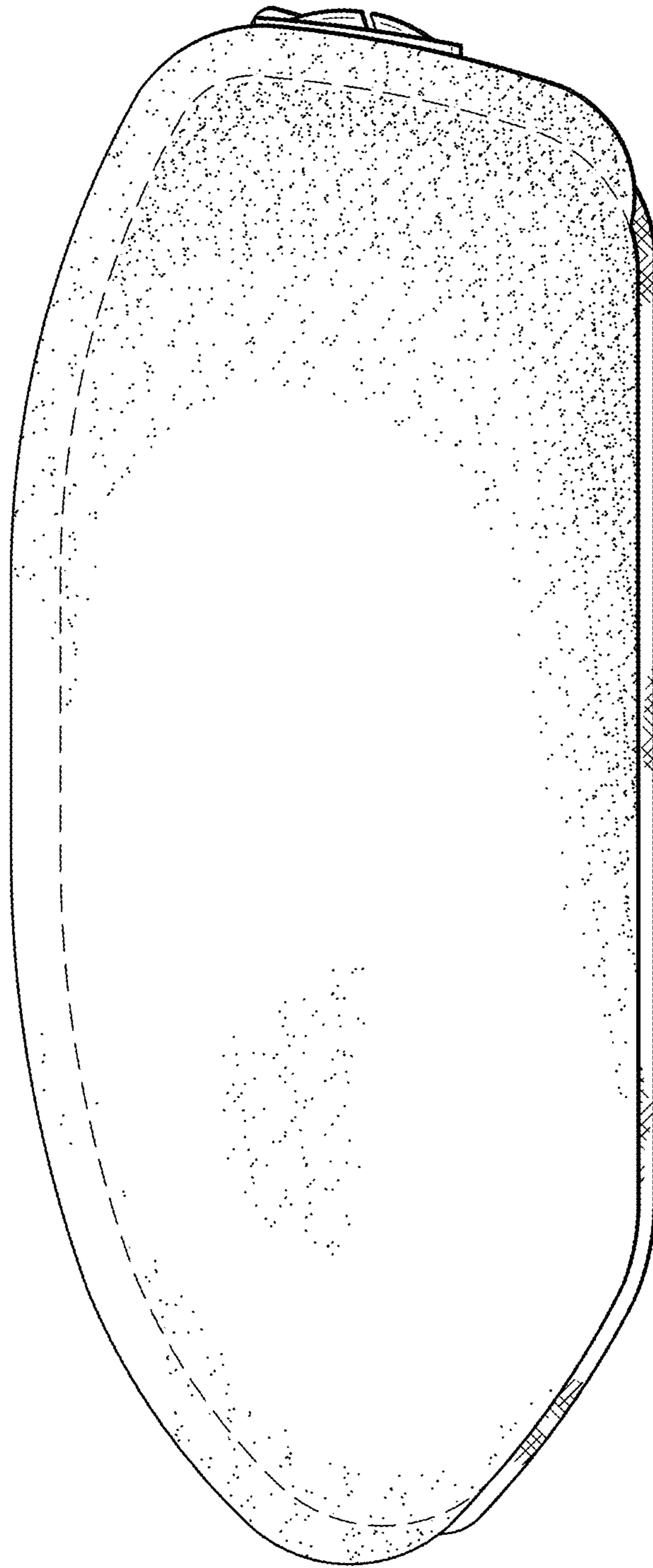

FIG. 5

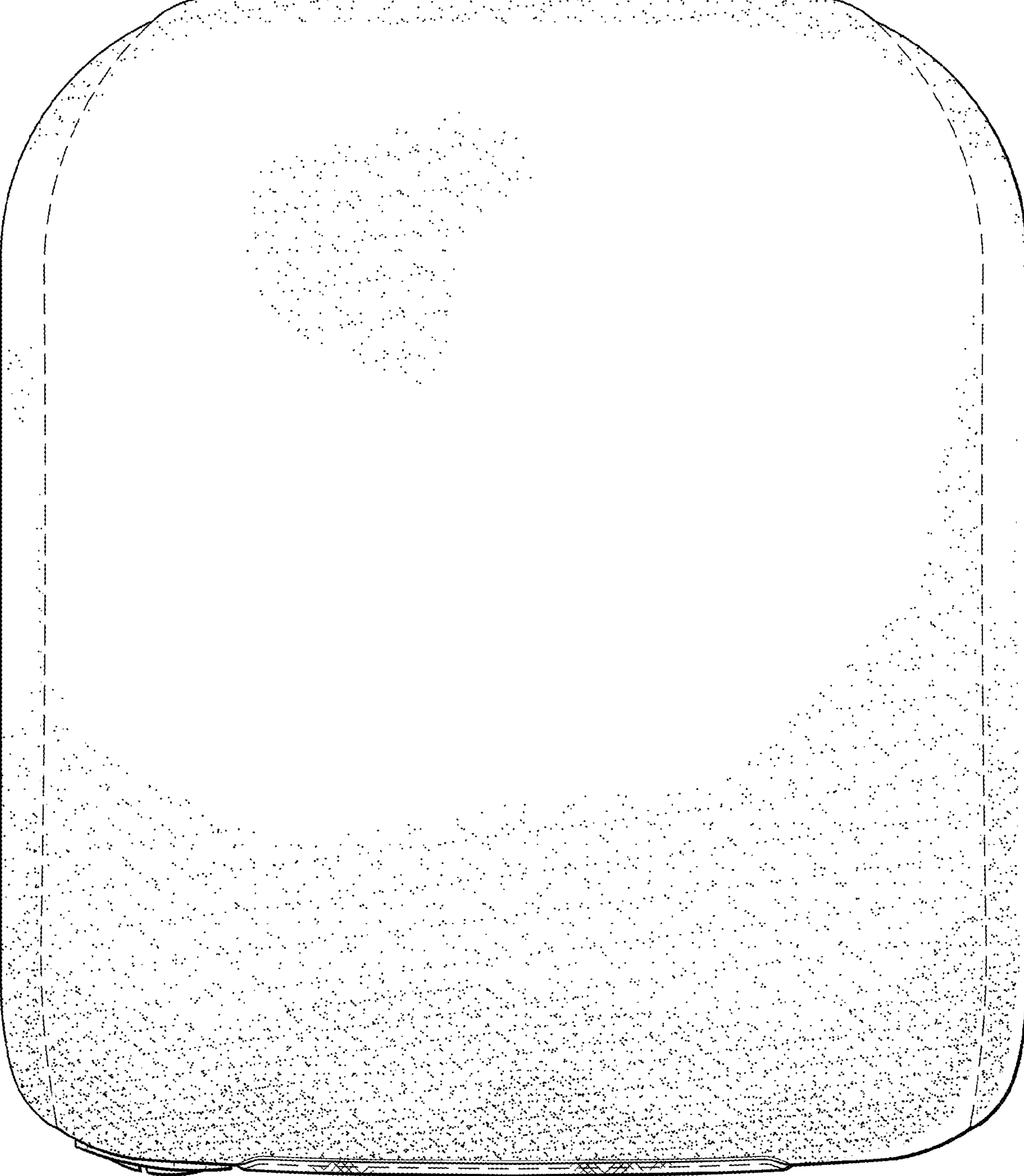

FIG. 6

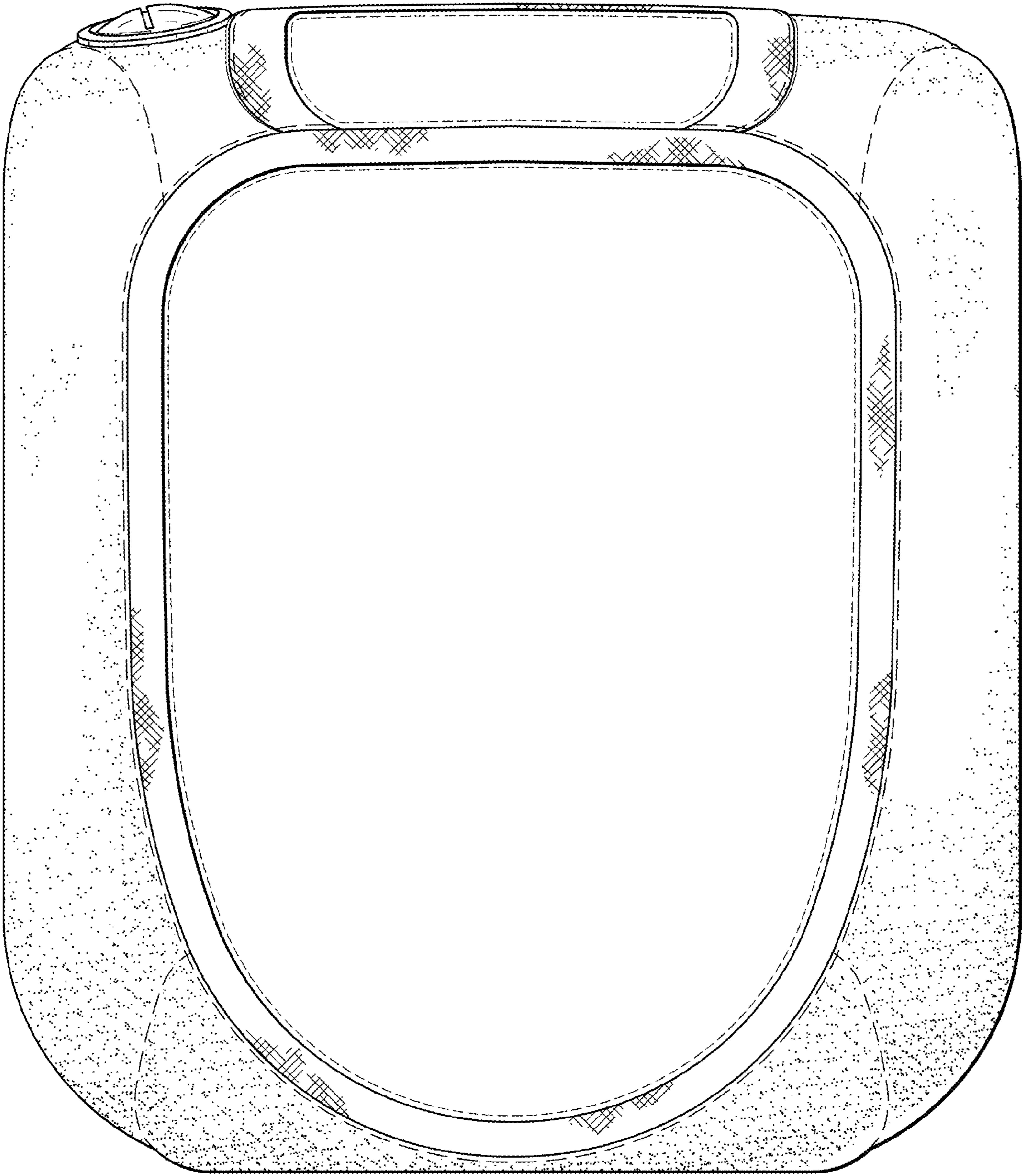

FIG. 7

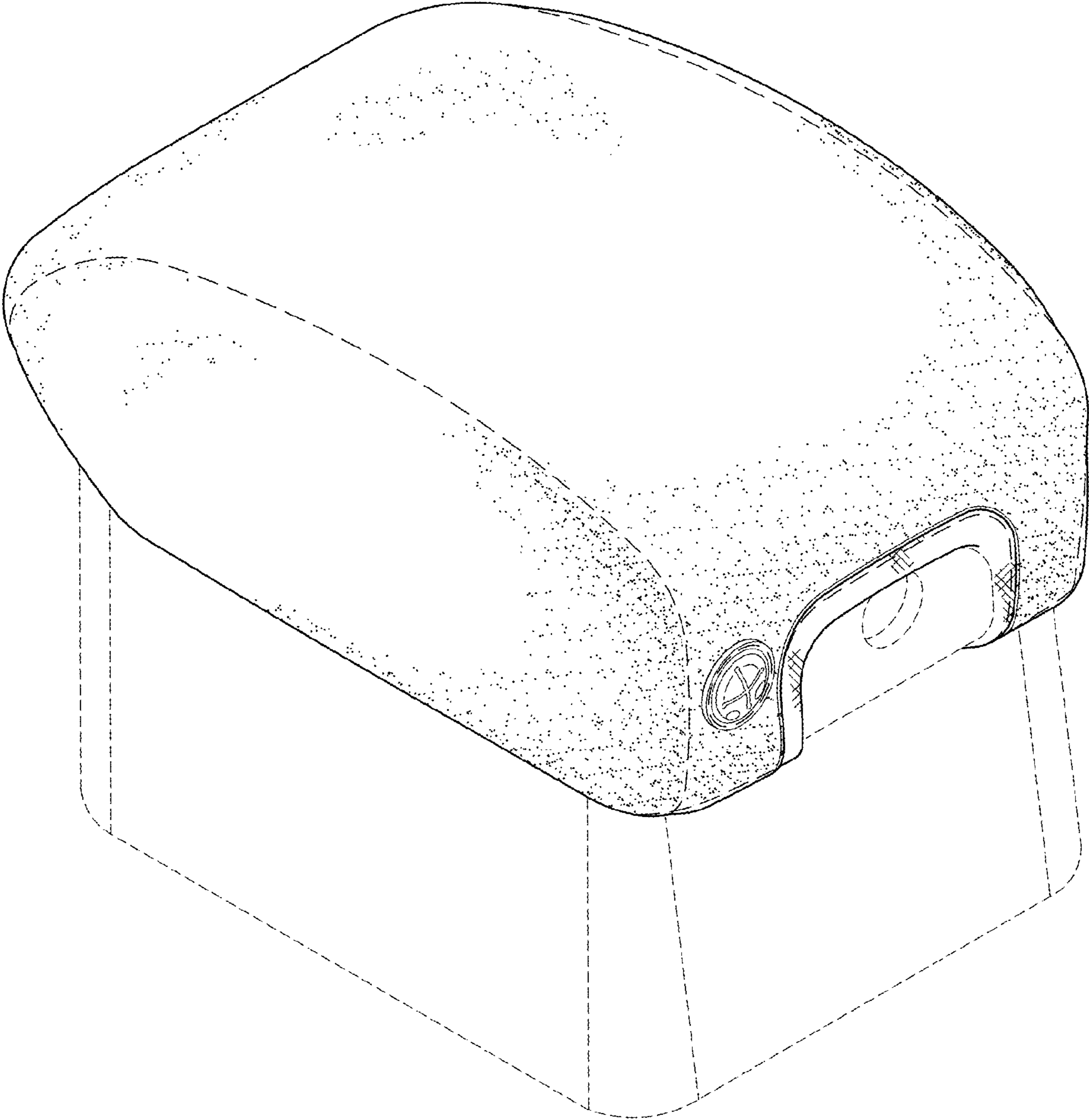

FIG. 8



US00D969056C1

(12) **EX PARTE REEXAMINATION CERTIFICATE** (12328th)
United States Patent
Wegesin

(10) **Number:** **US D969,056 C1**
(45) **Certificate Issued:** **Jun. 30, 2023**

(54) **VEHICLE CONSOLE COVER**

(71) Applicant: **Lady Edison & Co. LLC**, Dublin, OH (US)

(72) Inventor: **Andrew Wegesin**, Dublin, OH (US)

(73) Assignee: **LADY EDISON & CO. LLC**, Sarasota, FL (US)

(51) **LOC (14) Cl.** 12-16

(52) **U.S. Cl.**
USPC **D12/401; D12/415**

(58) **Field of Classification Search**
USPC D12/400, 415, 416, 421, 422, 423
CPC B60R 13/10; B60B 7/12
See application file for complete search history.

Reexamination Request:

No. 90/015,168, Nov. 27, 2022

Reexamination Certificate for:

Patent No.: **Des. 969,056**

Issued: **Nov. 8, 2022**

Appl. No.: **29/750,568**

Filed: **Sep. 15, 2020**

(56) **References Cited**

To view the complete listing of prior art documents cited during the proceeding for Reexamination Control Number 90/015,168, please refer to the USPTO's Patent Electronic System.

Primary Examiner — Philip S Hyder

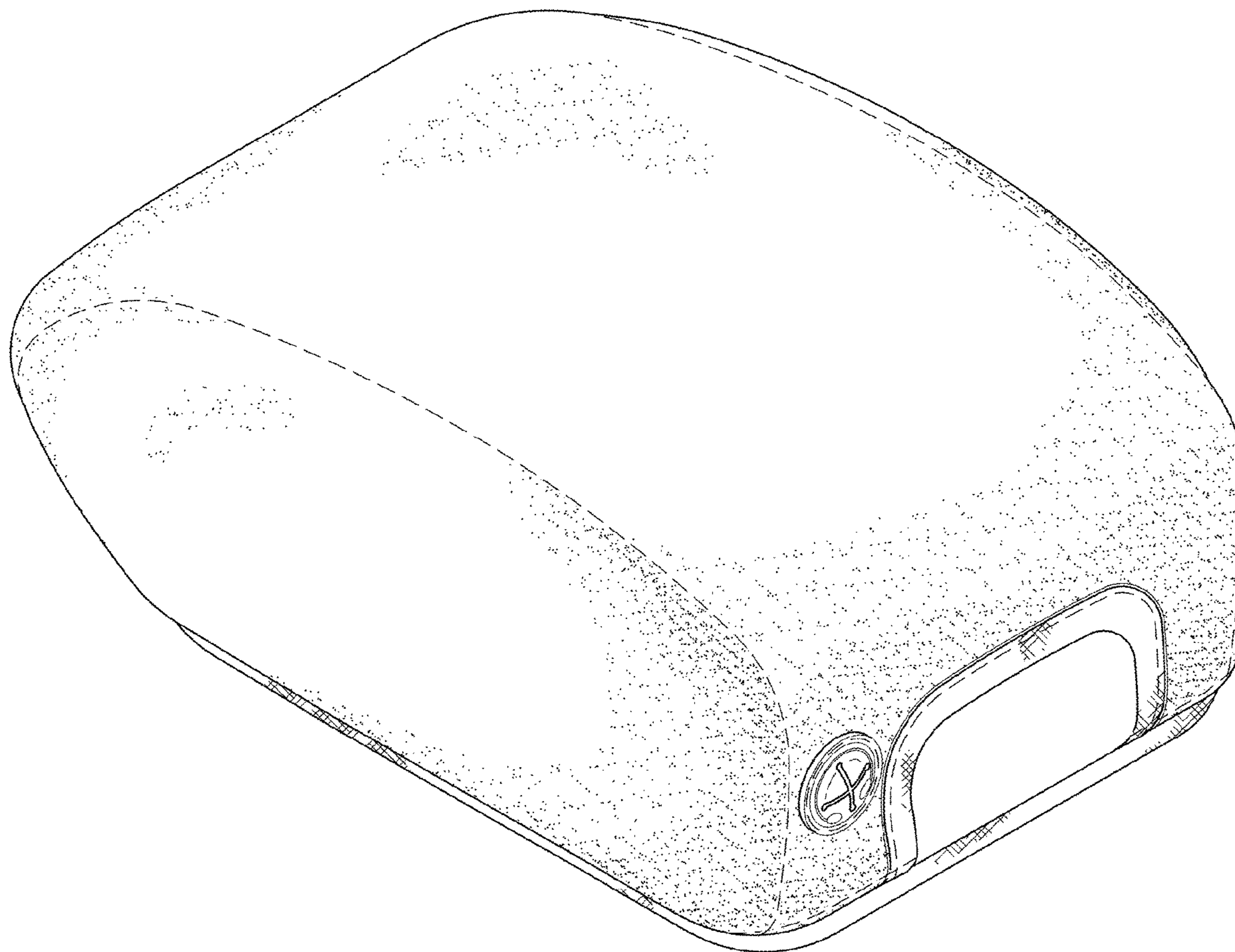

1
EX PARTE
REEXAMINATION CERTIFICATE

NO AMENDMENTS HAVE BEEN MADE TO
THE PATENT

5

AS A RESULT OF REEXAMINATION, IT HAS BEEN
DETERMINED THAT:

The patentability of claim 1 is confirmed.

10

* * * * *