

US00D969037S

(12) **United States Design Patent** (10) **Patent No.:** **US D969,037 S**
Clottu (45) **Date of Patent:** **** Nov. 8, 2022**

(54) **RADIATOR GRILLE FOR A VEHICLE**

(71) Applicant: **Bayerische Motoren Werke Aktiengesellschaft, Munich (DE)**

(72) Inventor: **Fabien Clottu, Munich (DE)**

(73) Assignee: **Bayerische Motoren Werke Aktiengesellschaft, Munich (DE)**

(**) Term: **15 Years**

(21) Appl. No.: **29/786,460**

(22) Filed: **Jun. 1, 2021**

(30) **Foreign Application Priority Data**

Dec. 4, 2020 (DE) 402020101153.3

(51) **LOC (13) Cl.** **12-16**

(52) **U.S. Cl.**
USPC **D12/163**

(58) **Field of Classification Search**
USPC D12/163, 196, 86, 90-92, 169, 190, 98,
D12/164; 293/102, 113, 115, 117, 120,
293/193.11; 296/180.1, 180.2; 180/68.1,
180/68.6

CPC B60R 19/52; B60K 11/08; B62D 25/08;
B62B 9/16

See application file for complete search history.

(56) **References Cited**

U.S. PATENT DOCUMENTS

- D787,377 S 5/2017 Al Attar
- D818,890 S * 5/2018 Beermann D12/163
- D820,737 S * 6/2018 Simm D12/163
- D821,274 S * 6/2018 Simm D12/163
- D821,921 S 7/2018 Scully et al.
- D823,737 S * 7/2018 Chang D12/163
- D825,383 S * 8/2018 Luk D12/91
- D835,546 S * 12/2018 Sarremejean D12/91
- D845,834 S * 4/2019 Sarremejean D12/91

- D855,496 S * 8/2019 Thogersen D12/91
- D858,371 S * 9/2019 Sarremejean D12/163
- D859,227 S * 9/2019 Buckingham D12/163
- D871,266 S 12/2019 Ojea
- D873,725 S 1/2020 Thogersen
- D874,358 S * 2/2020 Kezha D12/163
- D879,679 S * 3/2020 Kezha D12/163
- D890,639 S * 7/2020 Al Attar D12/163
- D891,317 S * 7/2020 Kang D12/163
- D898,630 S * 10/2020 Guille D12/163
- D926,643 S * 8/2021 Forrest D12/163
- D928,660 S * 8/2021 Lim D12/92
- D928,661 S * 8/2021 Lim D12/163
- D928,662 S * 8/2021 Lim D12/163

(Continued)

FOREIGN PATENT DOCUMENTS

WO WO DM/214535 5/2021

Primary Examiner — Melody N Brown

(74) *Attorney, Agent, or Firm* — Crowell & Moring LLP

(57) **CLAIM**

The ornamental design for a radiator grille for a vehicle, as shown and described.

DESCRIPTION

This application contains subject matter related to the following co-pending U.S. design patent application: Application Ser. No. 29/786,458, filed Jun. 1, 2021 and entitled "Radiataor Grille for a Vehicle."

FIG. 1 is a front view of a radiator grille for a vehicle according to the design;

FIG. 2 is a right, front perspective view thereof;

FIG. 3 is a left, bottom perspective view thereof;

FIG. 4 is a right side view thereof;

FIG. 5 is a left side view thereof;

FIG. 6 is a top view thereof;

FIG. 7 is a bottom view thereof; and,

FIG. 8 is a rear view thereof.

1 Claim, 8 Drawing Sheets

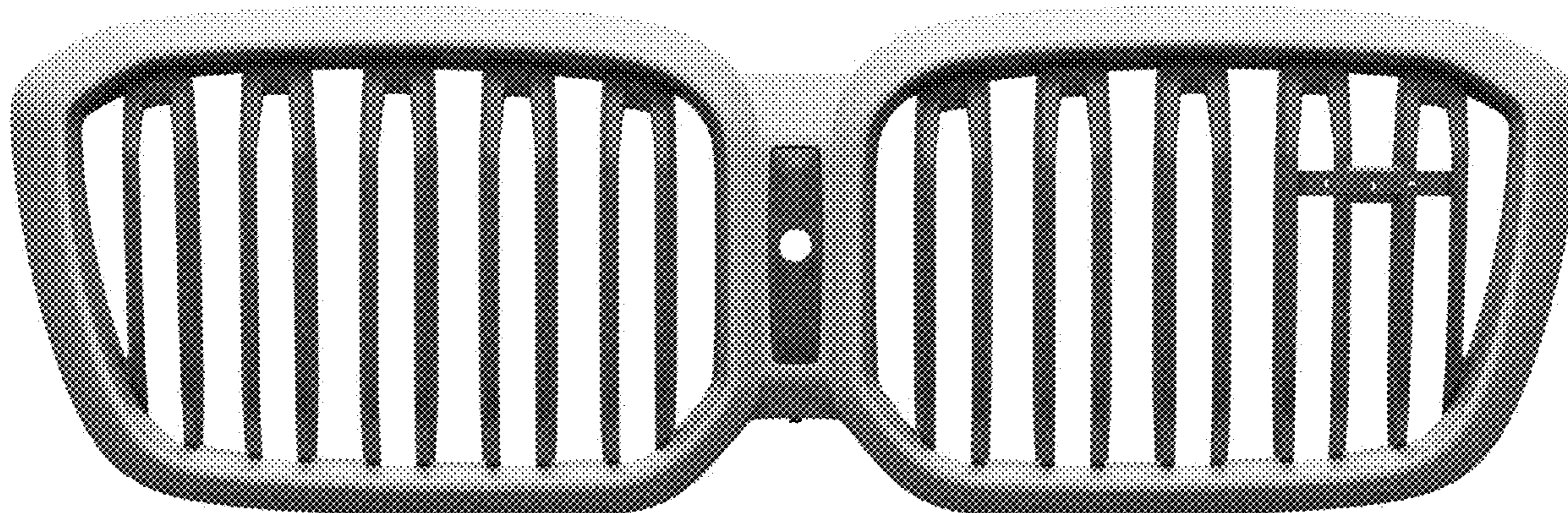

(56)

References Cited

U.S. PATENT DOCUMENTS

D939,391 S * 12/2021 Lim D12/163
D951,826 S * 5/2022 Forschner D12/163

* cited by examiner

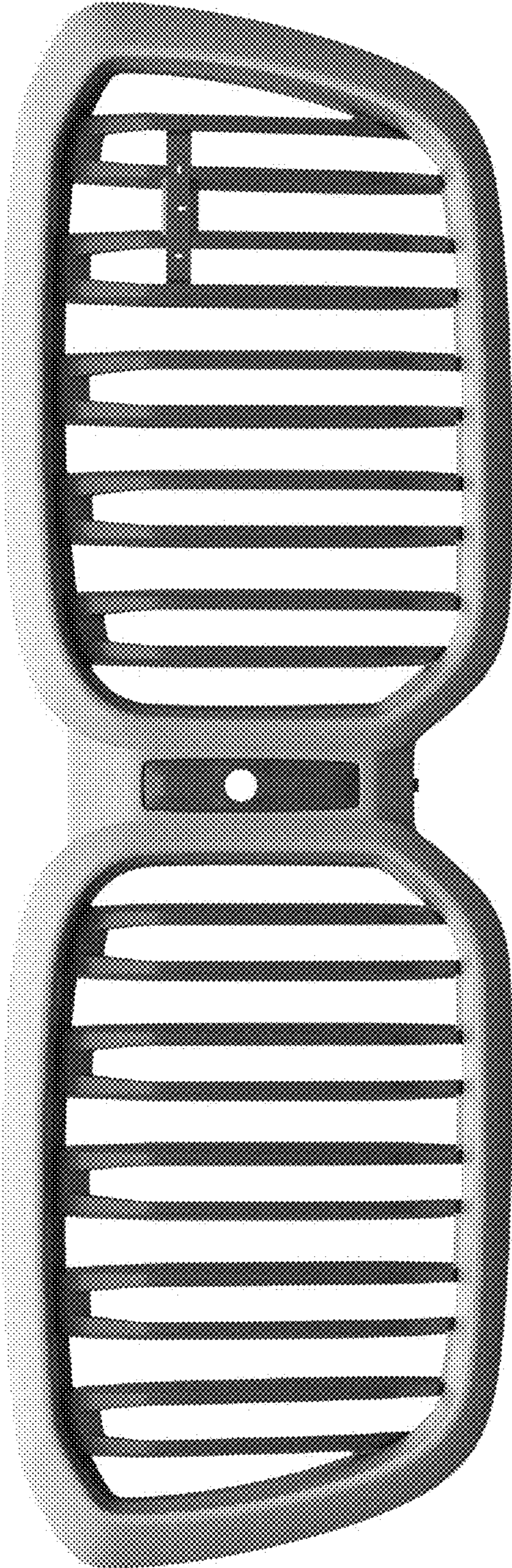

Fig. 1

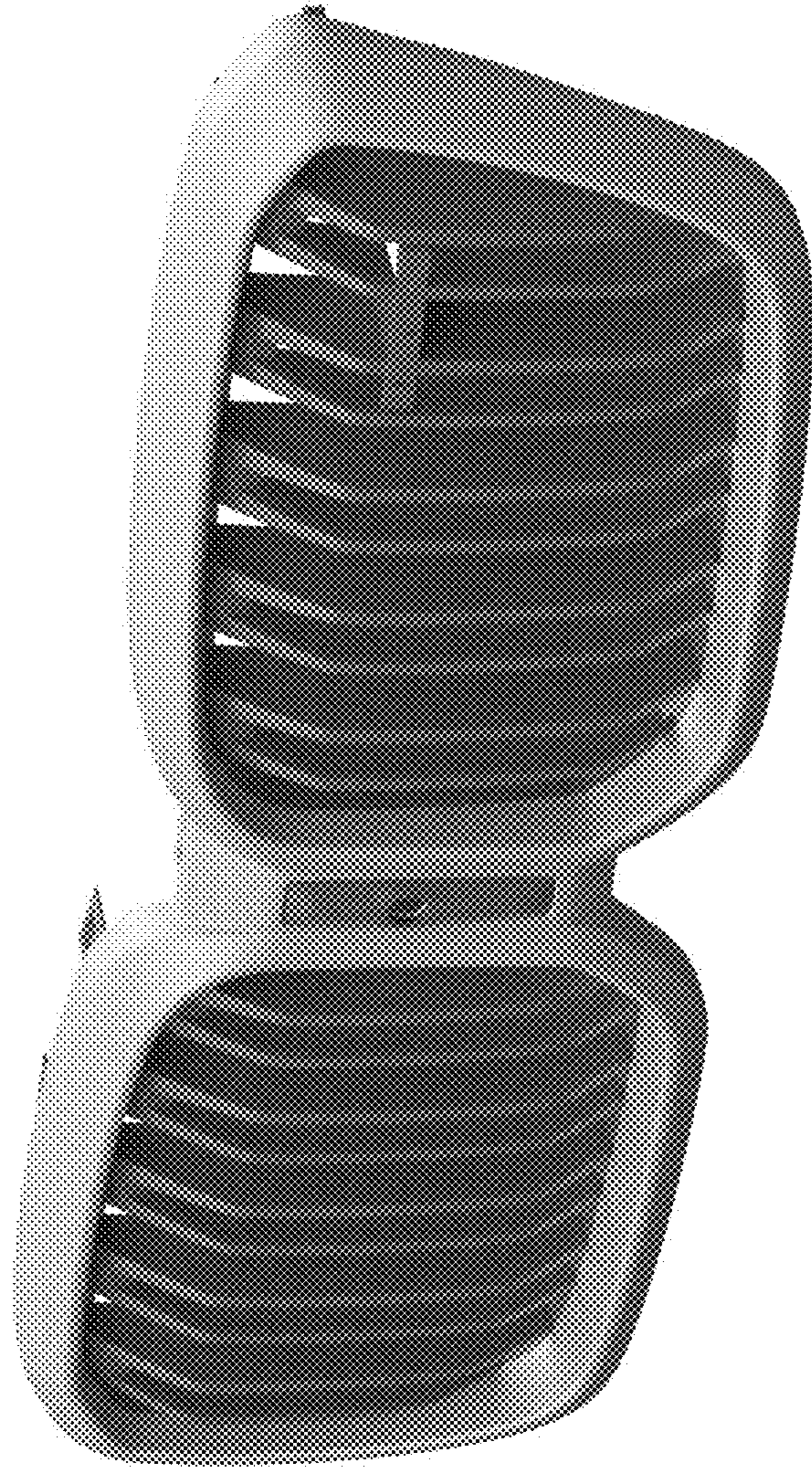

Fig. 2

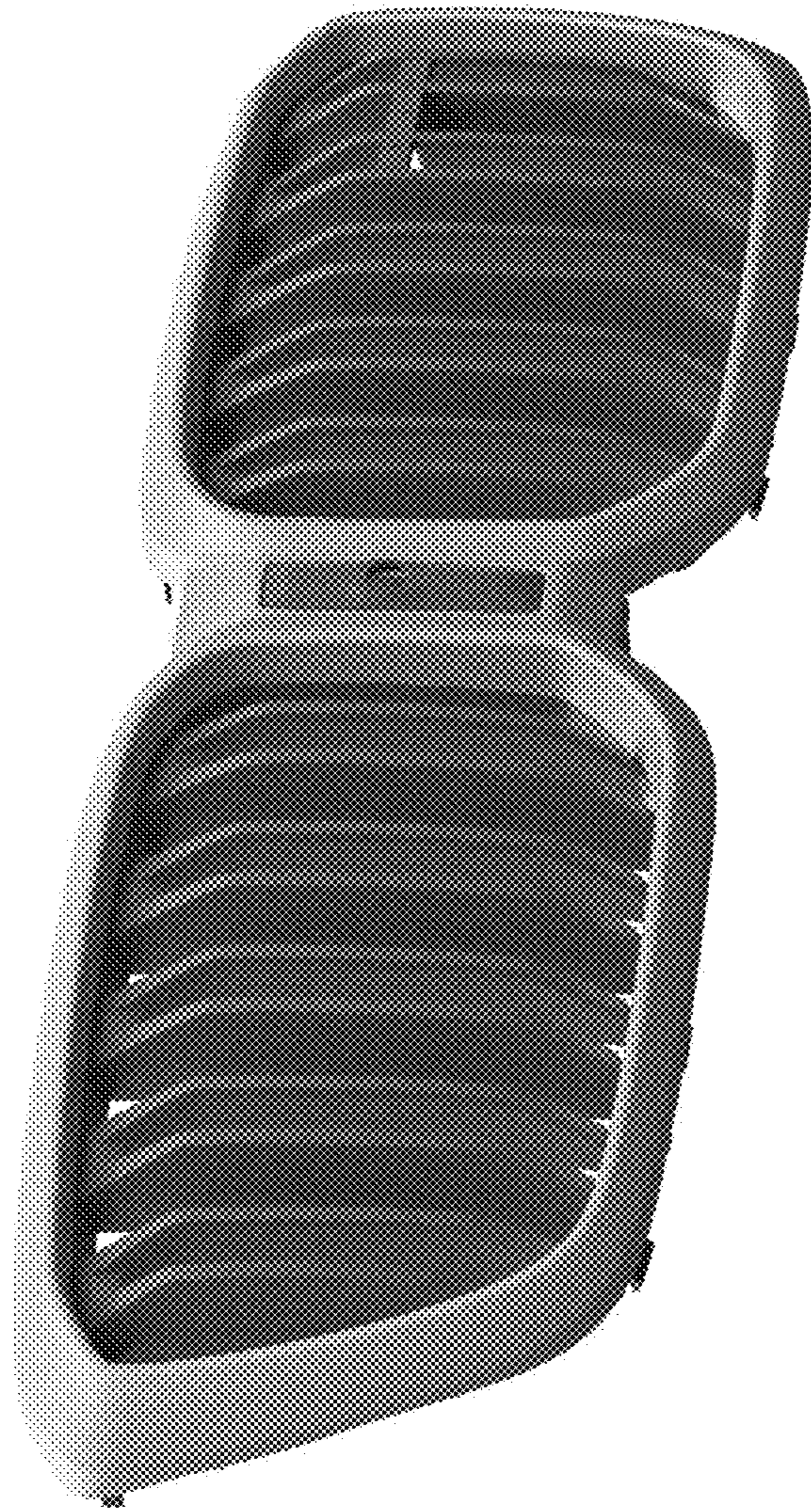

Fig. 3

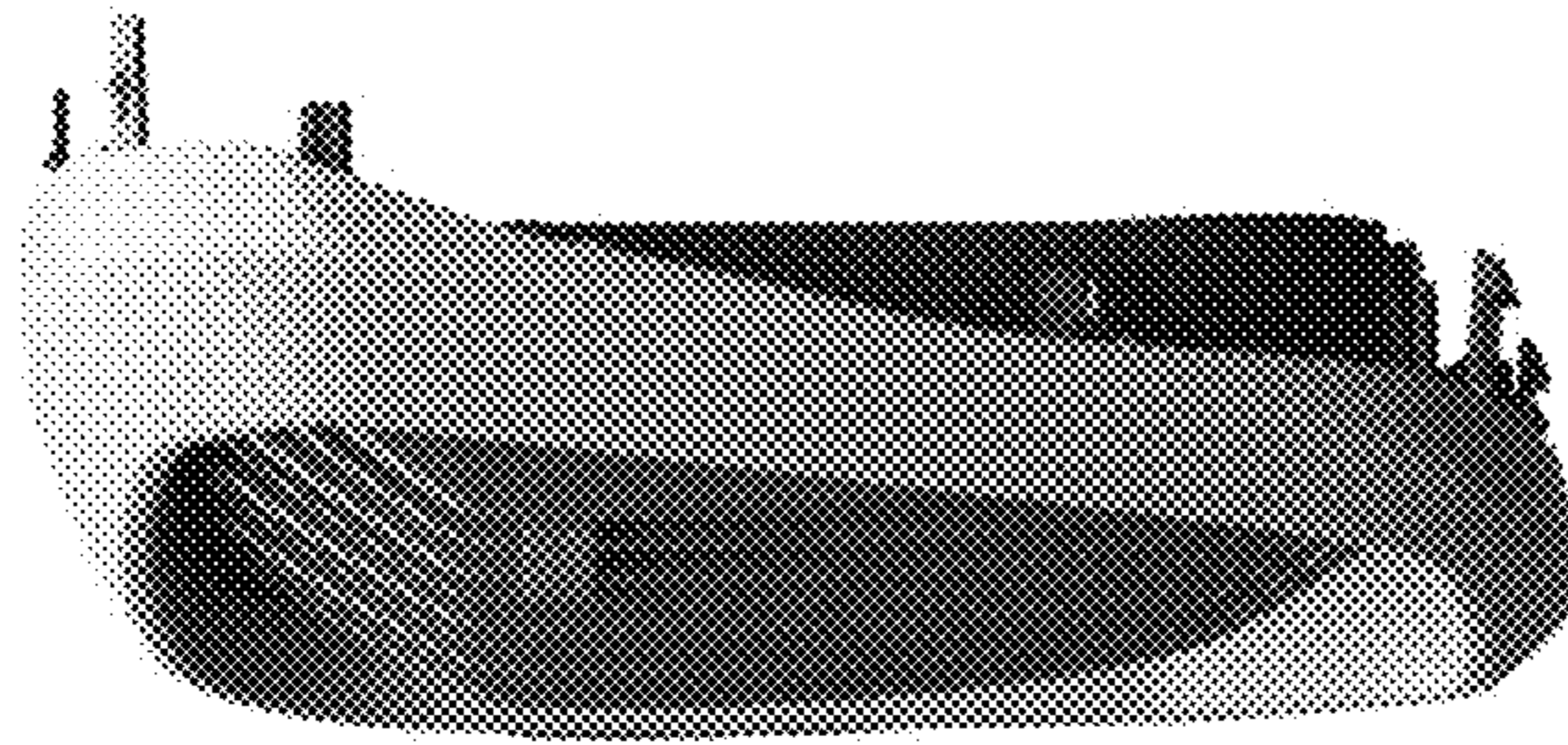

Fig. 4

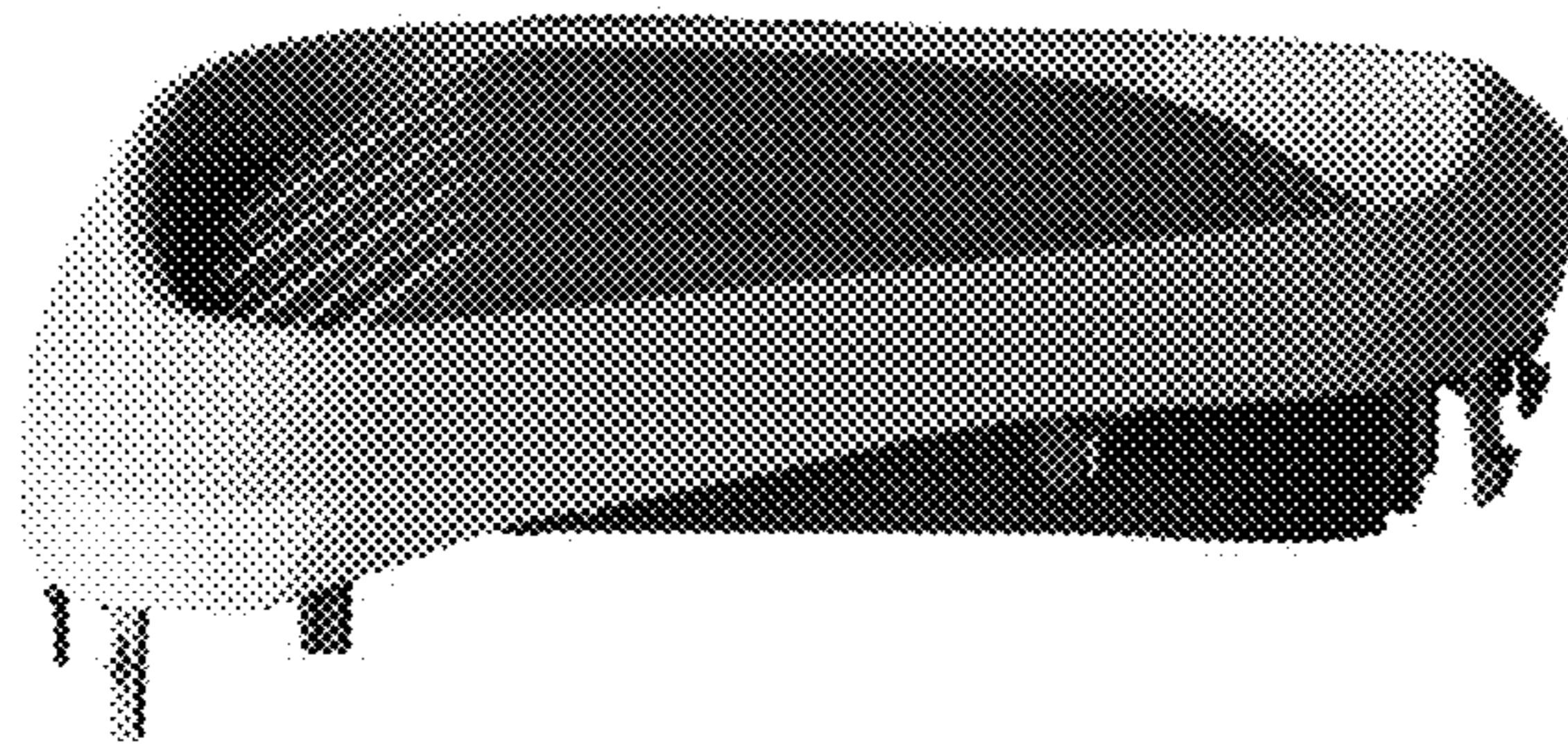

Fig. 5

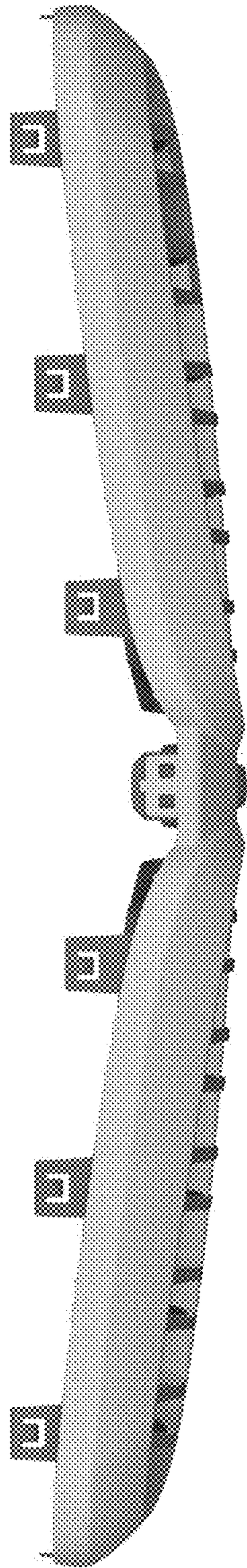

Fig. 6

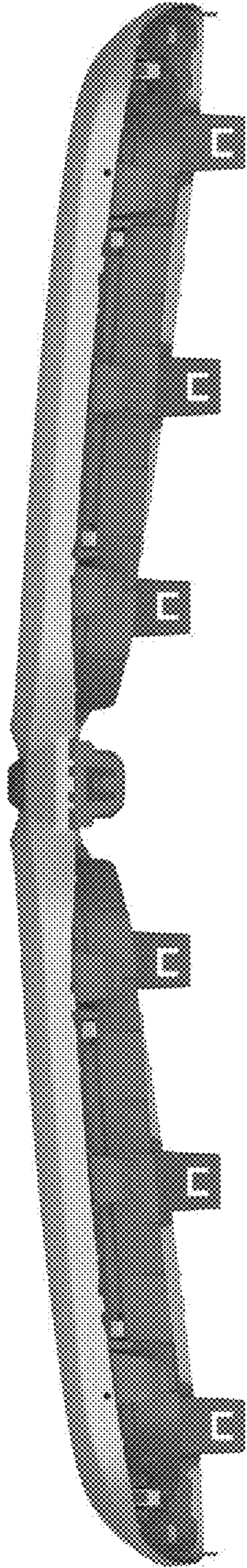

Fig. 7

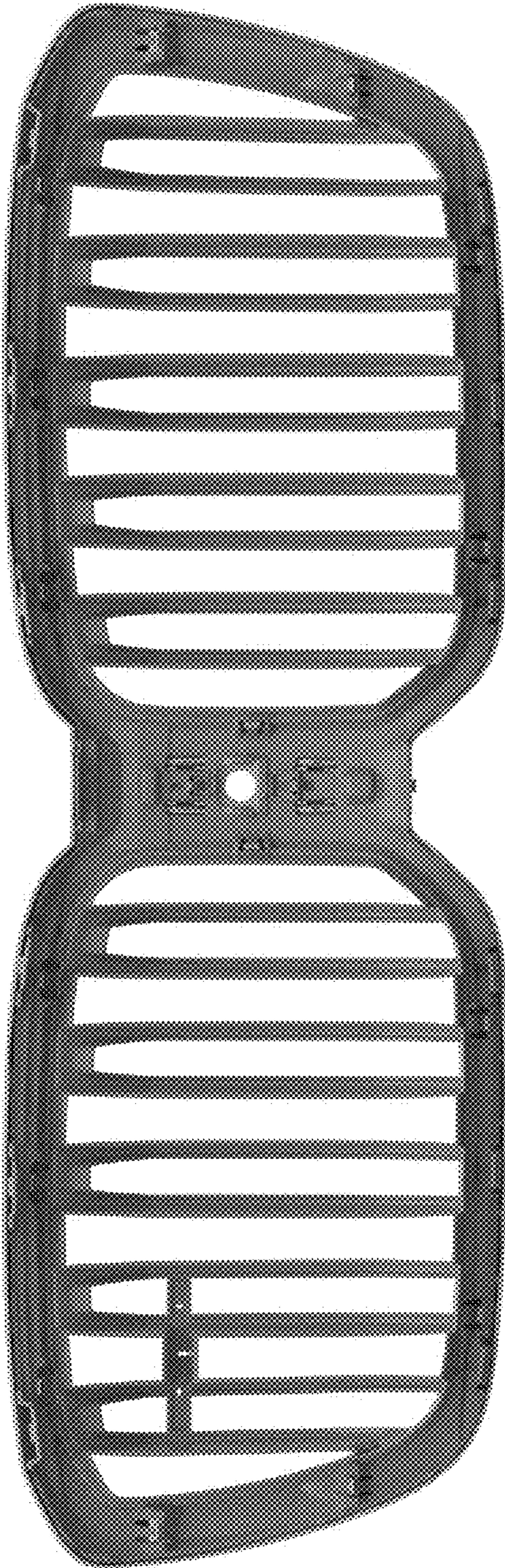

Fig. 8