



US00D968930S

(12) **United States Design Patent** (10) **Patent No.:** **US D968,930 S**  
**Agbato** (45) **Date of Patent:** **\*\* Nov. 8, 2022**

(54) **COOLER LATCH**

(71) Applicant: **Olufemi A. Agbato**, Alpharetta, GA (US)

(72) Inventor: **Olufemi A. Agbato**, Alpharetta, GA (US)

(73) Assignee: **Dam Coolers, LLC**, Alpharetta, GA (US)

(\*\*) Term: **15 Years**

(21) Appl. No.: **29/741,438**

(22) Filed: **Jul. 13, 2020**

(51) **LOC (13) Cl.** ..... **08-07**

(52) **U.S. Cl.**  
USPC ..... **D8/336**

(58) **Field of Classification Search**  
USPC ..... D8/336  
CPC ..... E05B 65/48; E05B 65/50; E05B 65/5276;  
E05B 65/52; E05B 65/5246; E05B  
65/5253; E05B 65/5215; B65D 43/164;  
B65D 45/00; B65D 45/025; B65D 45/02;  
A45C 13/00; A45C 13/10; A45C 13/14;  
A45C 13/1084; A45C 13/1076; E05C  
5/00; E05C 7/00; E05C 3/12

See application file for complete search history.

(56) **References Cited**

U.S. PATENT DOCUMENTS

6,497,438 B1 \* 12/2002 Holub ..... E05B 17/0025  
292/240  
D727,134 S \* 4/2015 Yamamoto ..... D8/336  
2014/0376992 A1 \* 12/2014 Wu ..... A45C 13/00  
403/155  
2018/0354687 A1 \* 12/2018 Seiders ..... B65D 45/24

\* cited by examiner

*Primary Examiner* — Doris Clark

(57) **CLAIM**

The ornamental design for a cooler latch, as shown and described.

**DESCRIPTION**

FIG. 1 is a perspective view of a cooler latch showing my new design;  
FIG. 2 is a front elevation view thereof;  
FIG. 3 is a right-side elevation view thereof;  
FIG. 4 is a left-side elevation view thereof;  
FIG. 5 is a top plan view thereof; and,  
FIG. 6 is a bottom plan view thereof.

**1 Claim, 6 Drawing Sheets**

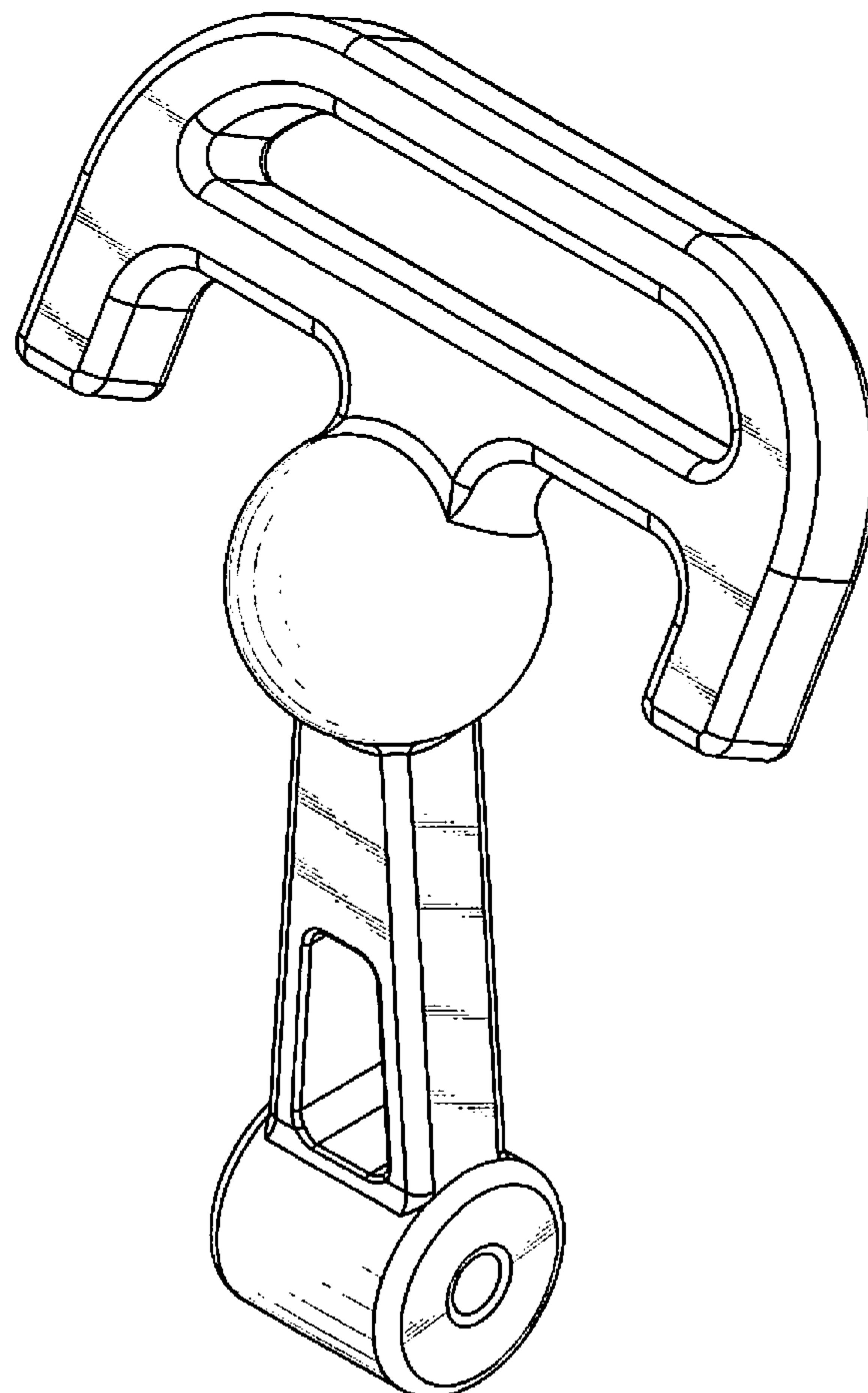

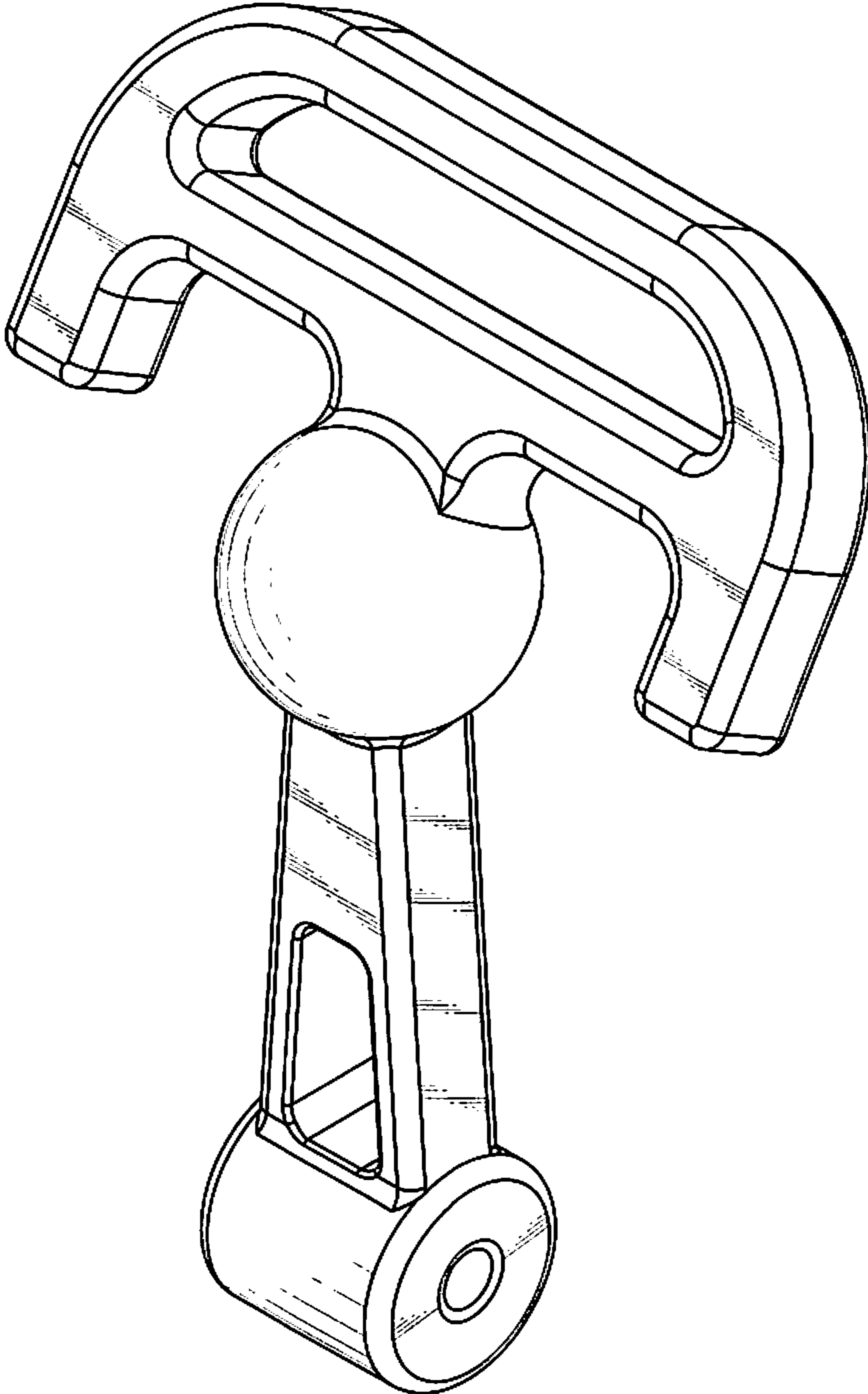

FIG. 1

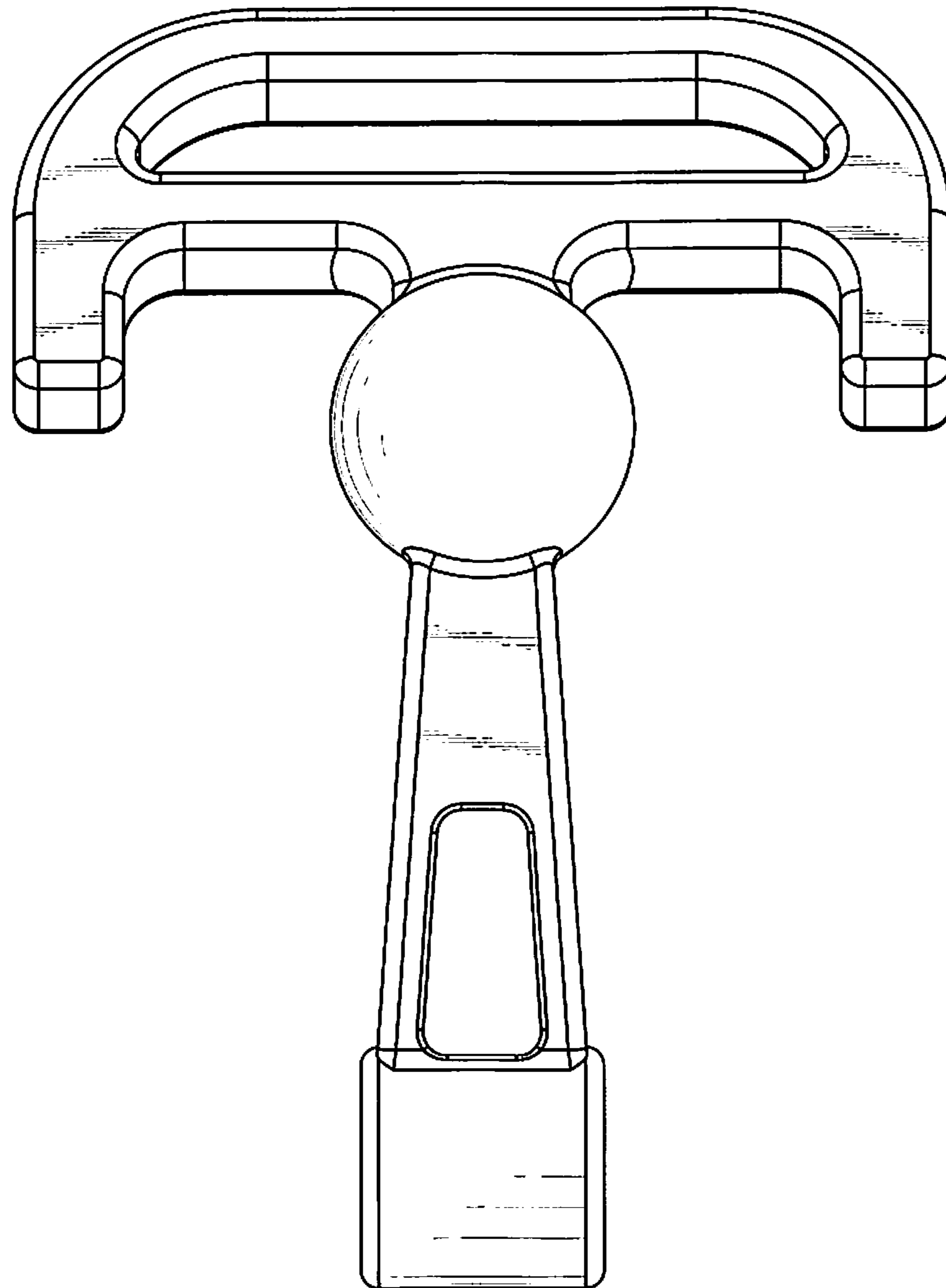

FIG. 2

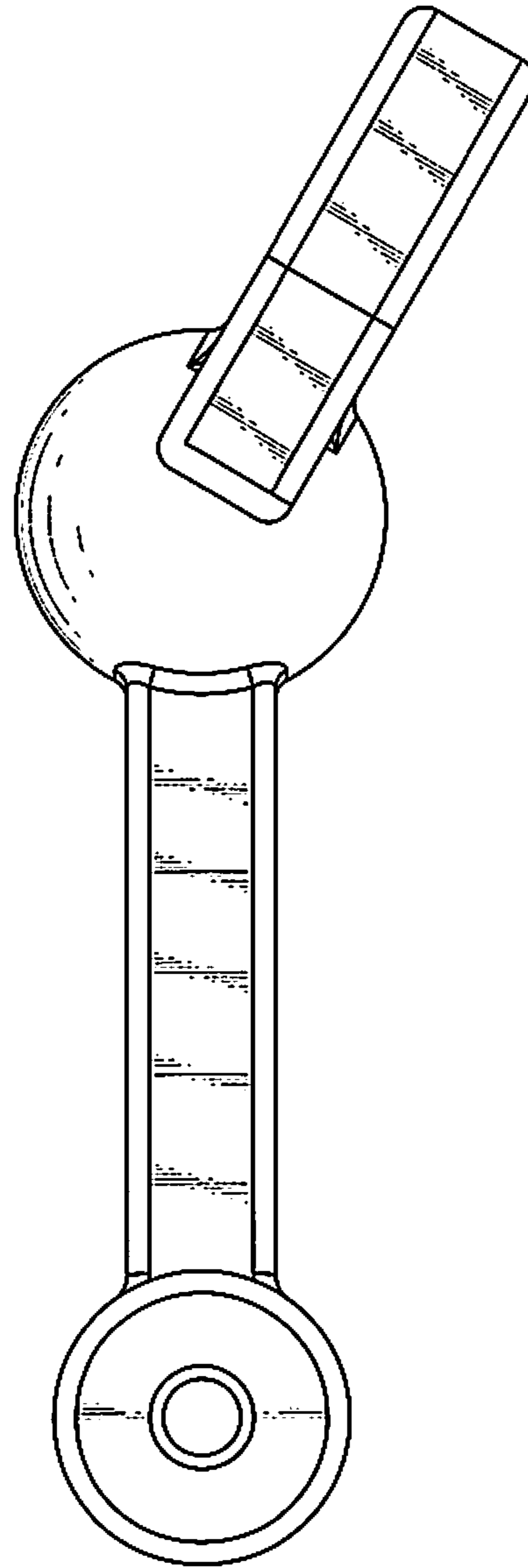

FIG. 3

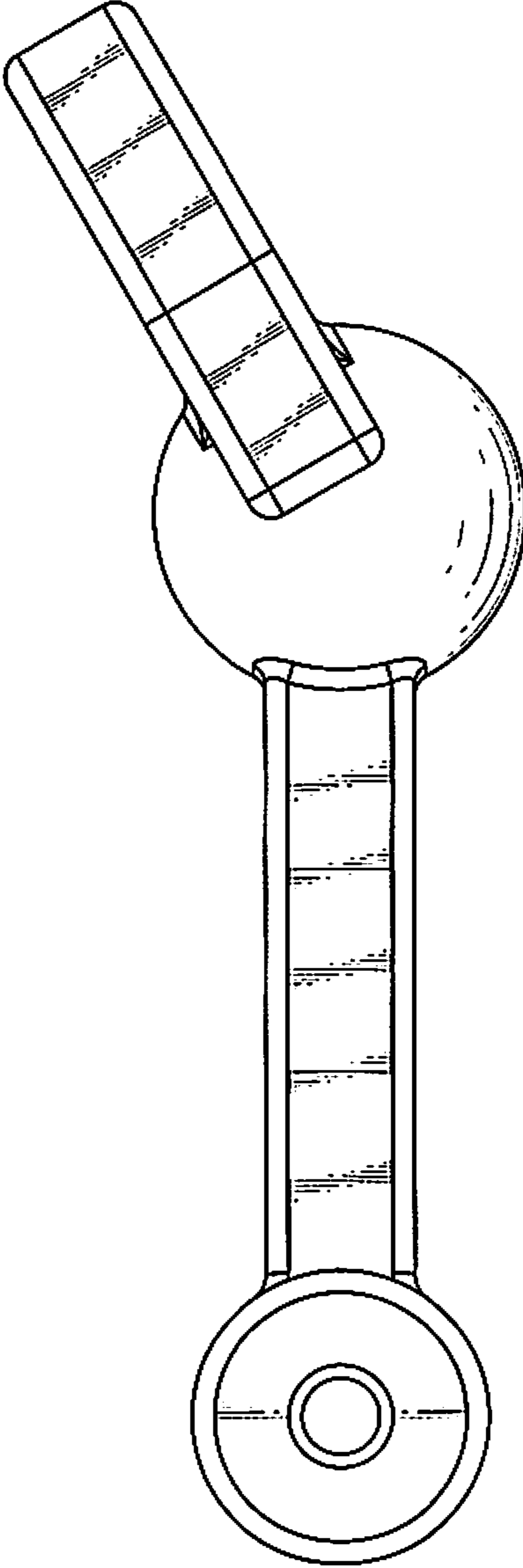

FIG. 4

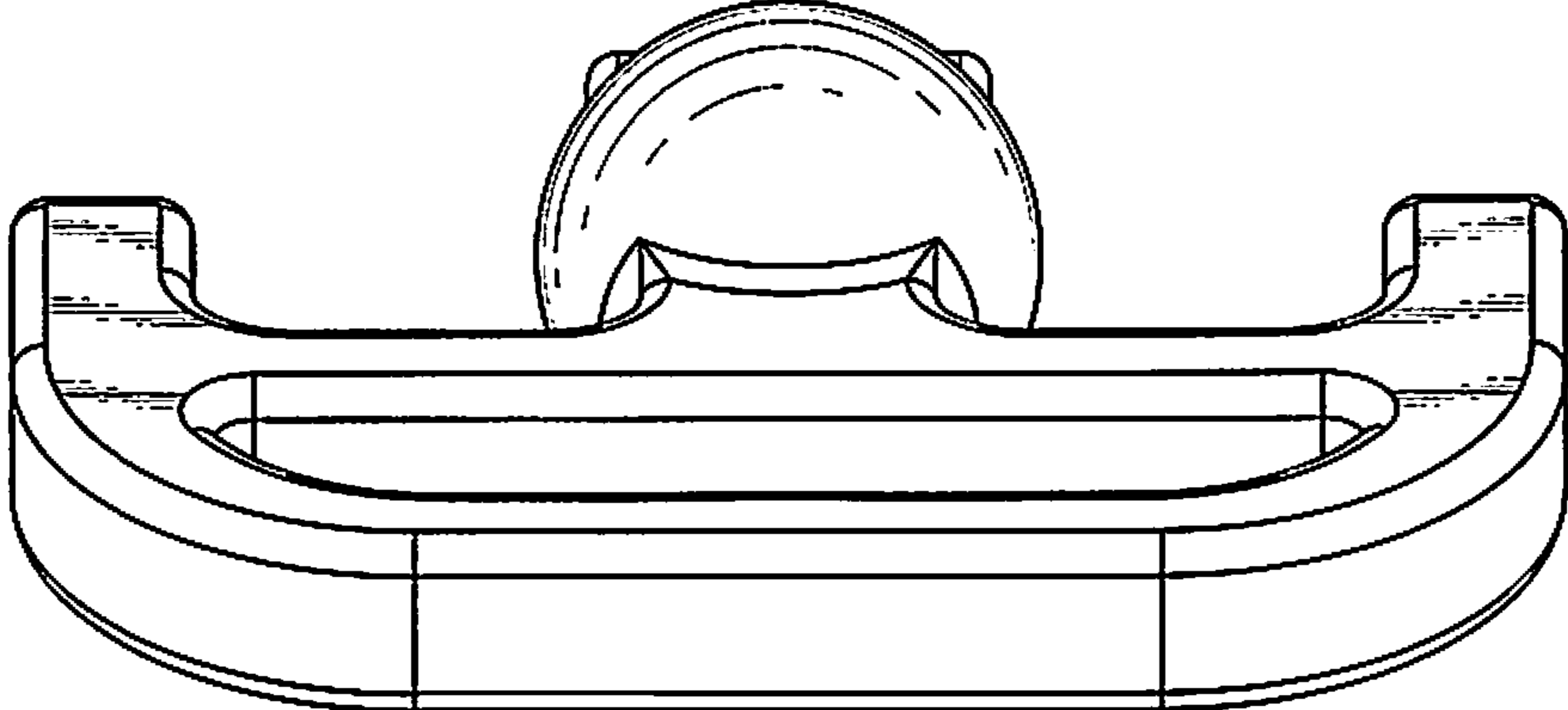

FIG. 5

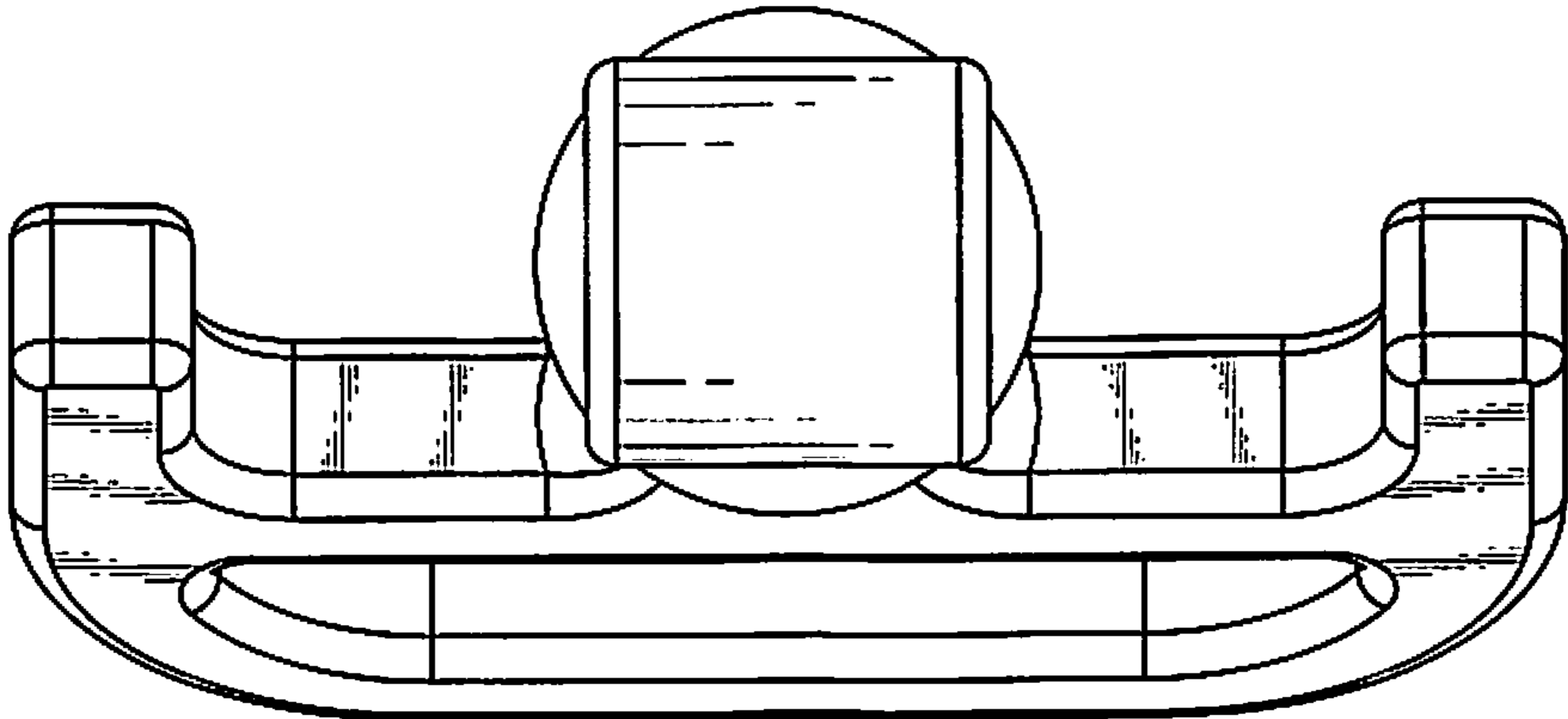

FIG. 6