



US00D968756S

(12) **United States Design Patent** (10) **Patent No.:** **US D968,756 S**
Chen (45) **Date of Patent:** **** Nov. 8, 2022**

(54) **MEN'S SPORTS SHORT**
(71) Applicant: **Quanzhou Lejia Trading Co., Ltd.,**
Quanzhou (CN)
(72) Inventor: **Rongyi Chen, Quanzhou (CN)**
(**) Term: **15 Years**
(21) Appl. No.: **29/842,656**
(22) Filed: **Jun. 15, 2022**
(51) **LOC (13) Cl.** **02-02**
(52) **U.S. Cl.**
USPC **D2/731**
(58) **Field of Classification Search**
USPC D2/700, 704, 712, 713, 716, 718, 728,
D2/731-734, 738, 742
CPC . A41D 1/08; A41D 1/089; A41D 7/00; A41D
7/005; A41D 13/0015; A41B 9/00; A41B
9/001; A41B 9/02
See application file for complete search history.

D778,539 S 2/2017 Kandarian
D779,158 S * 2/2017 Lomax D2/731
D792,057 S * 7/2017 Krocheski D2/731
D796,783 S * 9/2017 Moore D2/731
D801,634 S * 11/2017 Jackson D2/731
D803,520 S * 11/2017 Kelley D2/731
D821,061 S * 6/2018 Do D2/731
D825,140 S 8/2018 Bassett Asam
D827,250 S 9/2018 Sandieson
D839,540 S 2/2019 Elzeisa
10,219,553 B2 * 3/2019 Curran A41D 1/084
D866,125 S * 11/2019 Young D2/731
D915,030 S 4/2021 Pirene
D927,131 S * 8/2021 Manos-Gully D2/728
D939,189 S 12/2021 De Mulder
2010/0235964 A1 * 9/2010 Mickey A41D 13/129
112/475.13

(Continued)

Primary Examiner — Michelle E. Wilson
Assistant Examiner — Clese Moore, Jr.
(74) *Attorney, Agent, or Firm* — Rumit Ranjit Kanakia

(57) **CLAIM**

The ornamental design for a men's sports short, as shown and described.

DESCRIPTION

FIG. 1 is a perspective view of a men's sports short showing my new design;
FIG. 2 is another perspective view thereof;
FIG. 3 is a front elevational view thereof;
FIG. 4 is a rear elevational view thereof;
FIG. 5 is a left side view thereof;
FIG. 6 is a right side view thereof;
FIG. 7 is a top plan view thereof;
FIG. 8 is a bottom plan view thereof;
FIG. 9 is a partial enlarged view of FIG. 1;
FIG. 10 is a partial enlarged view of FIG. 2; and,
FIG. 11 is a partial enlarged view of FIG. 7.

1 Claim, 11 Drawing Sheets

(56) **References Cited**
U.S. PATENT DOCUMENTS

D352,814 S * 11/1994 Sherman D2/734
D377,557 S * 1/1997 Jagger D2/738
D383,889 S * 9/1997 Gallegos D2/742
D403,487 S * 1/1999 Crupi D2/731
D467,055 S 12/2002 Lyden
D487,609 S * 3/2004 Cruz D2/731
D597,281 S * 8/2009 Young D2/738
D673,347 S 1/2013 Sumpton
D674,166 S * 1/2013 Wilson D2/738
D690,079 S * 9/2013 Grosbol D2/738
D714,523 S * 10/2014 Stinson D2/738
D742,095 S 11/2015 Savage
D746,544 S * 1/2016 Curran D2/738
D747,845 S * 1/2016 Pasloski D2/731
D764,143 S 8/2016 Gallo
D774,279 S * 12/2016 Hawkins D2/731

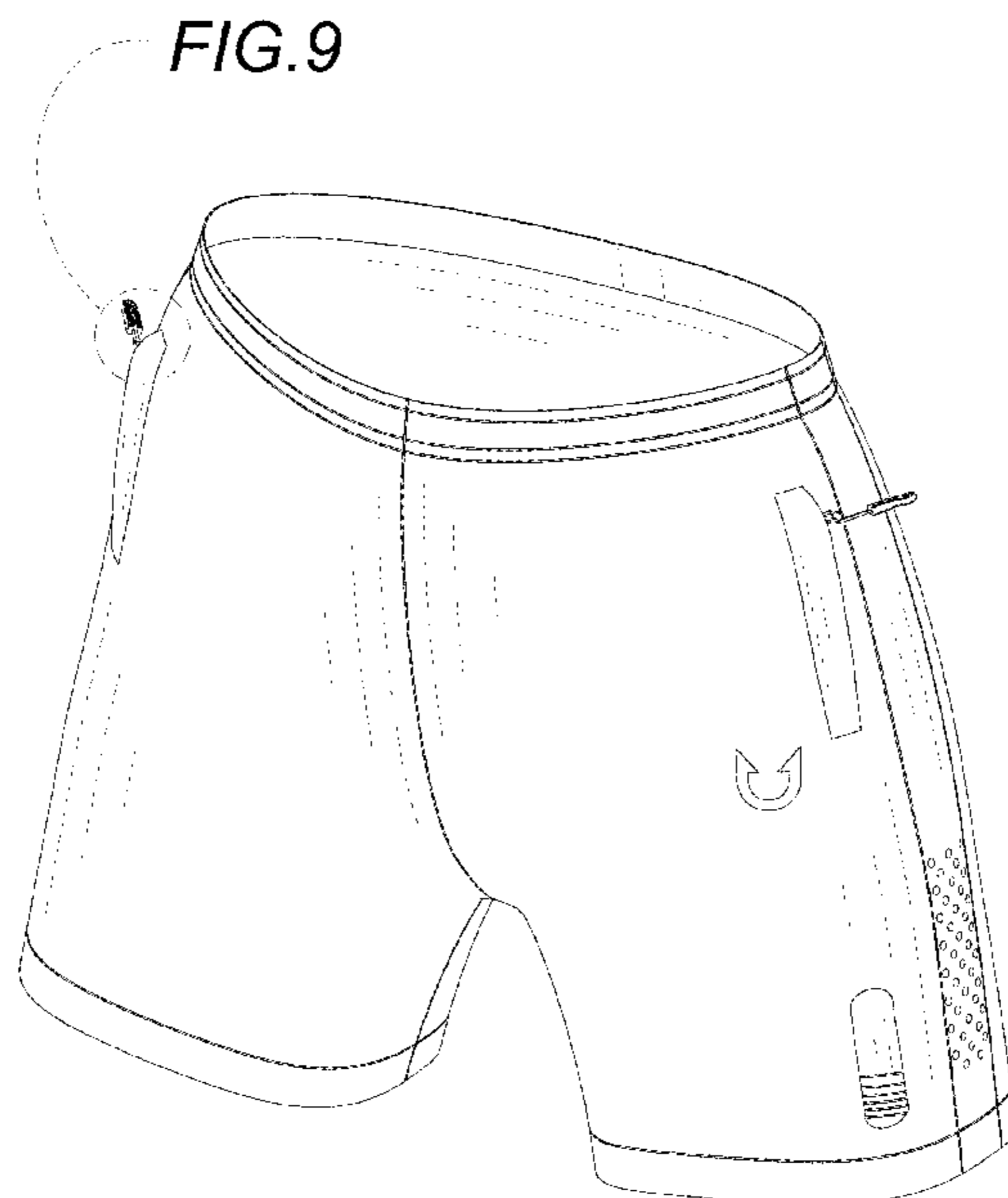

(56)

References Cited

U.S. PATENT DOCUMENTS

2011/0107495 A1* 5/2011 Moore A41D 7/005
2/236
2017/0035123 A1* 2/2017 Rodd A41D 15/00
2018/0035736 A1* 2/2018 Le A41D 27/20
2019/0274374 A1* 9/2019 Marconi A41B 9/026

* cited by examiner

FIG. 9

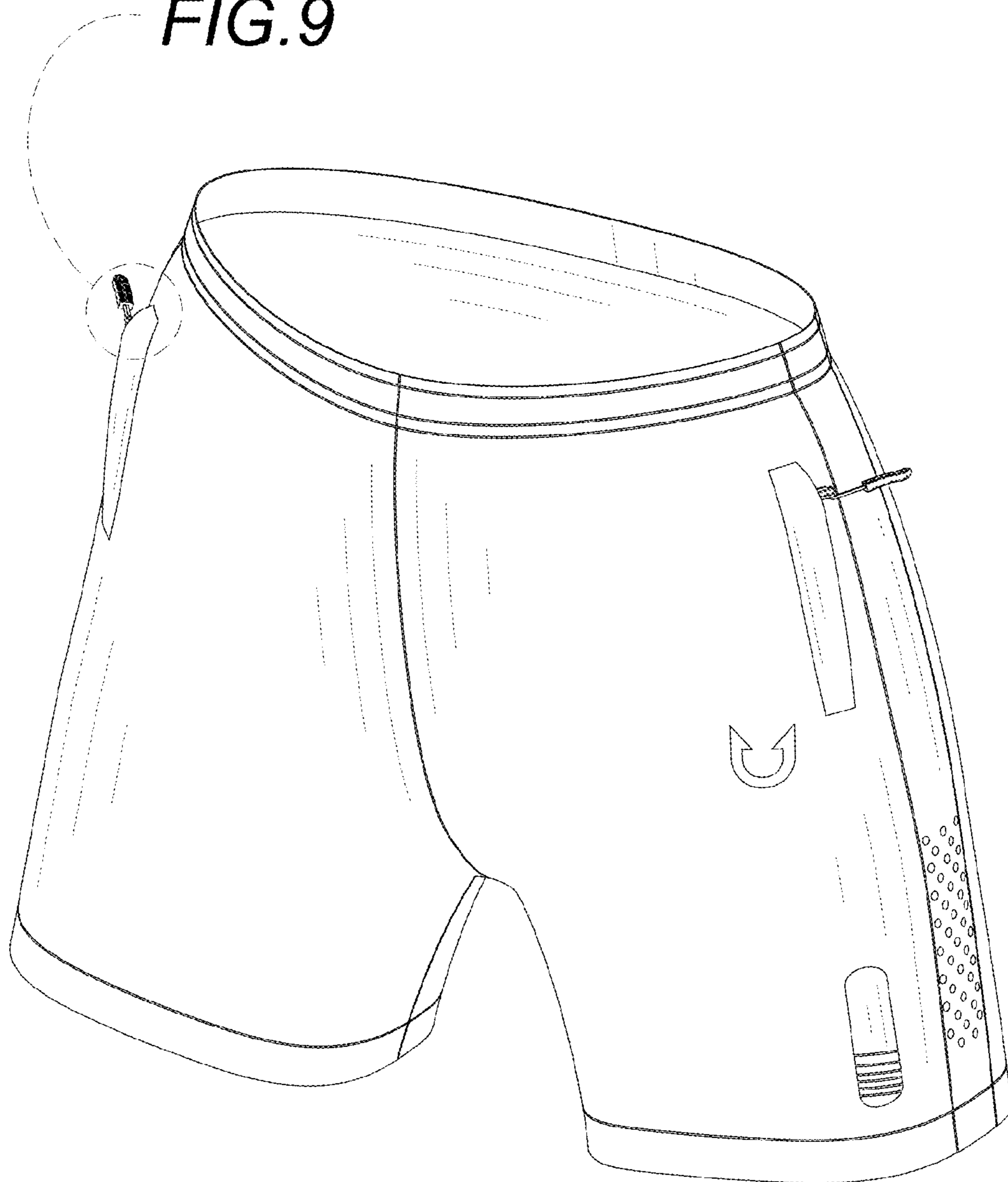

FIG. 1

FIG. 10

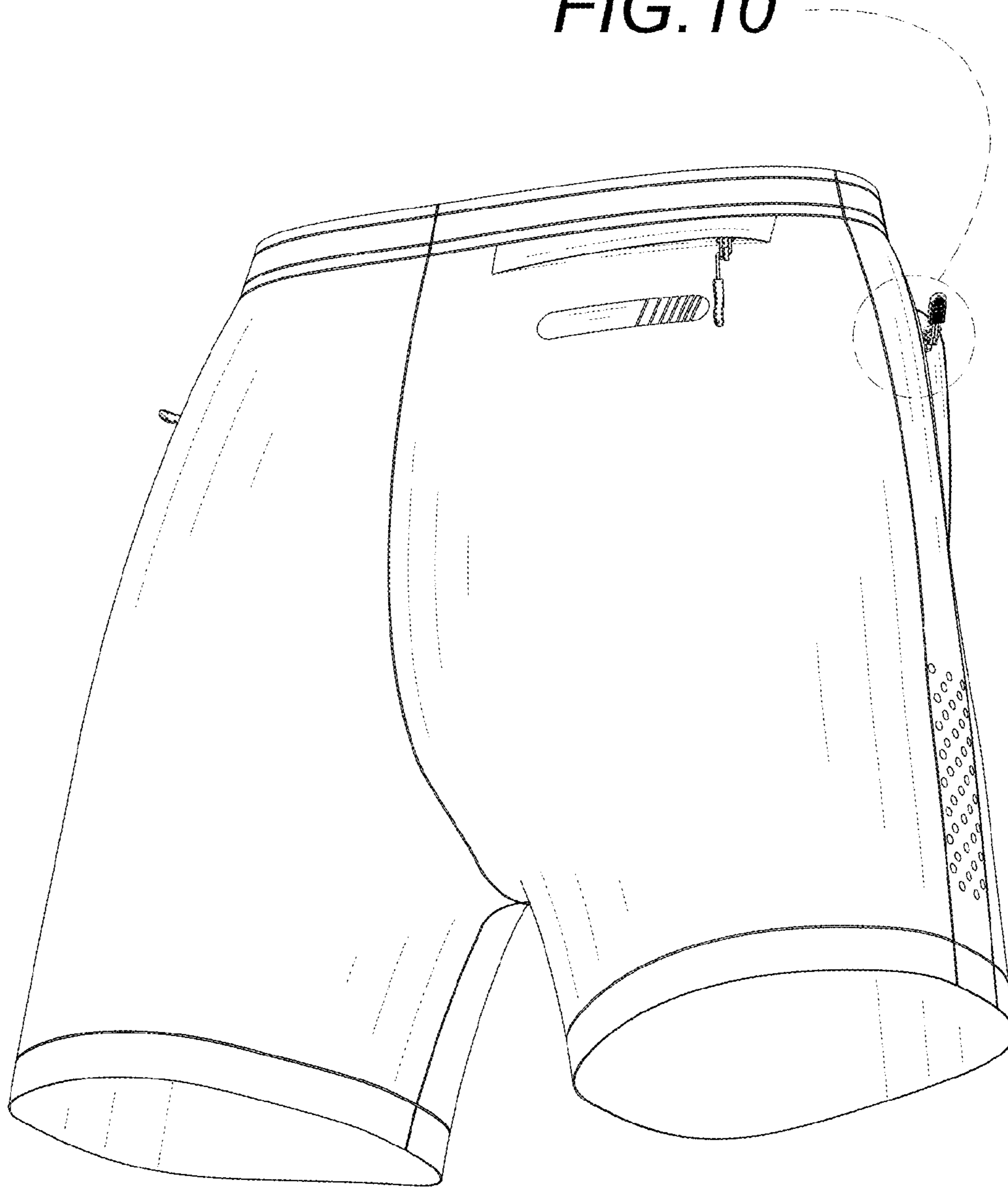

FIG. 2

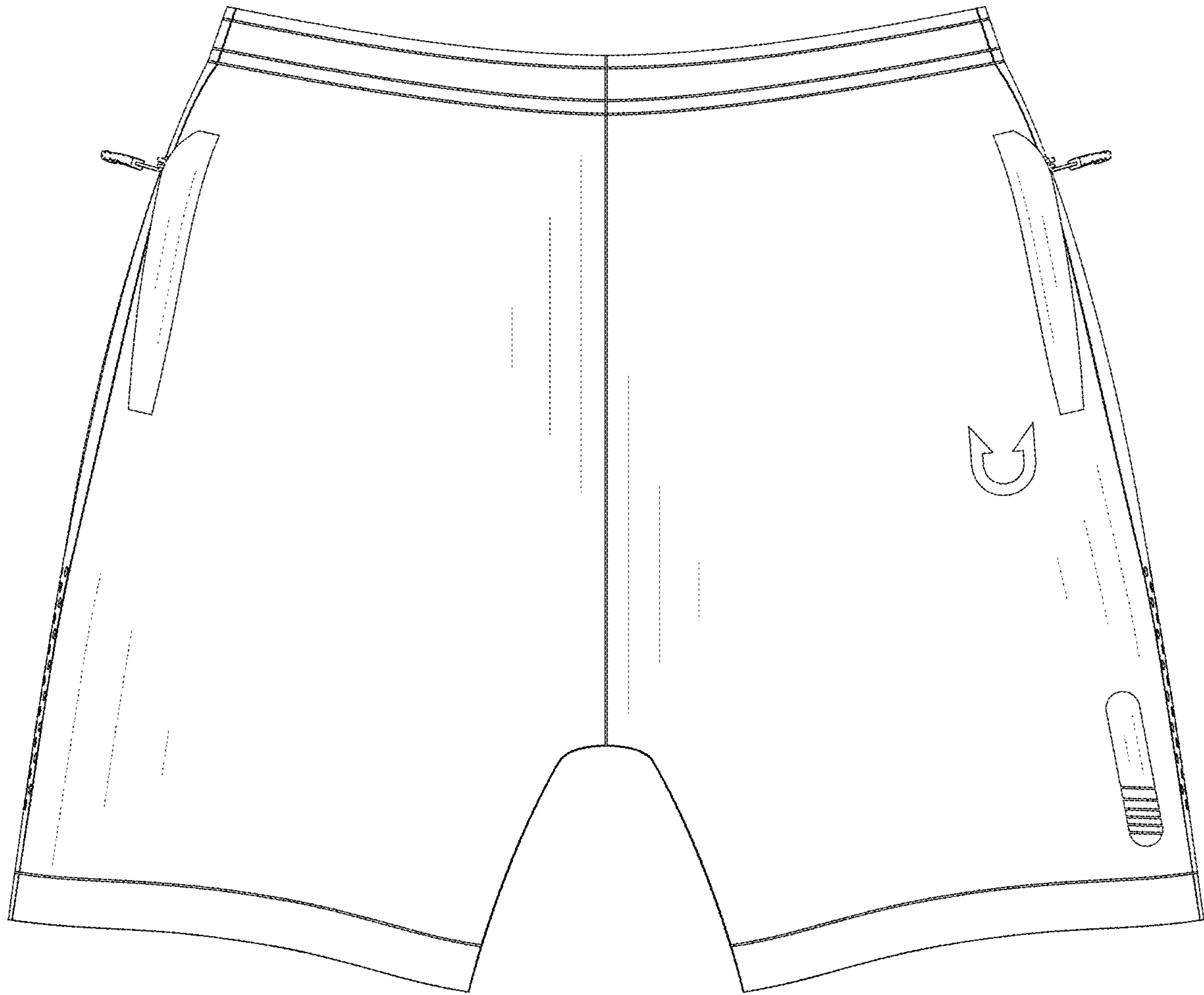

FIG. 3

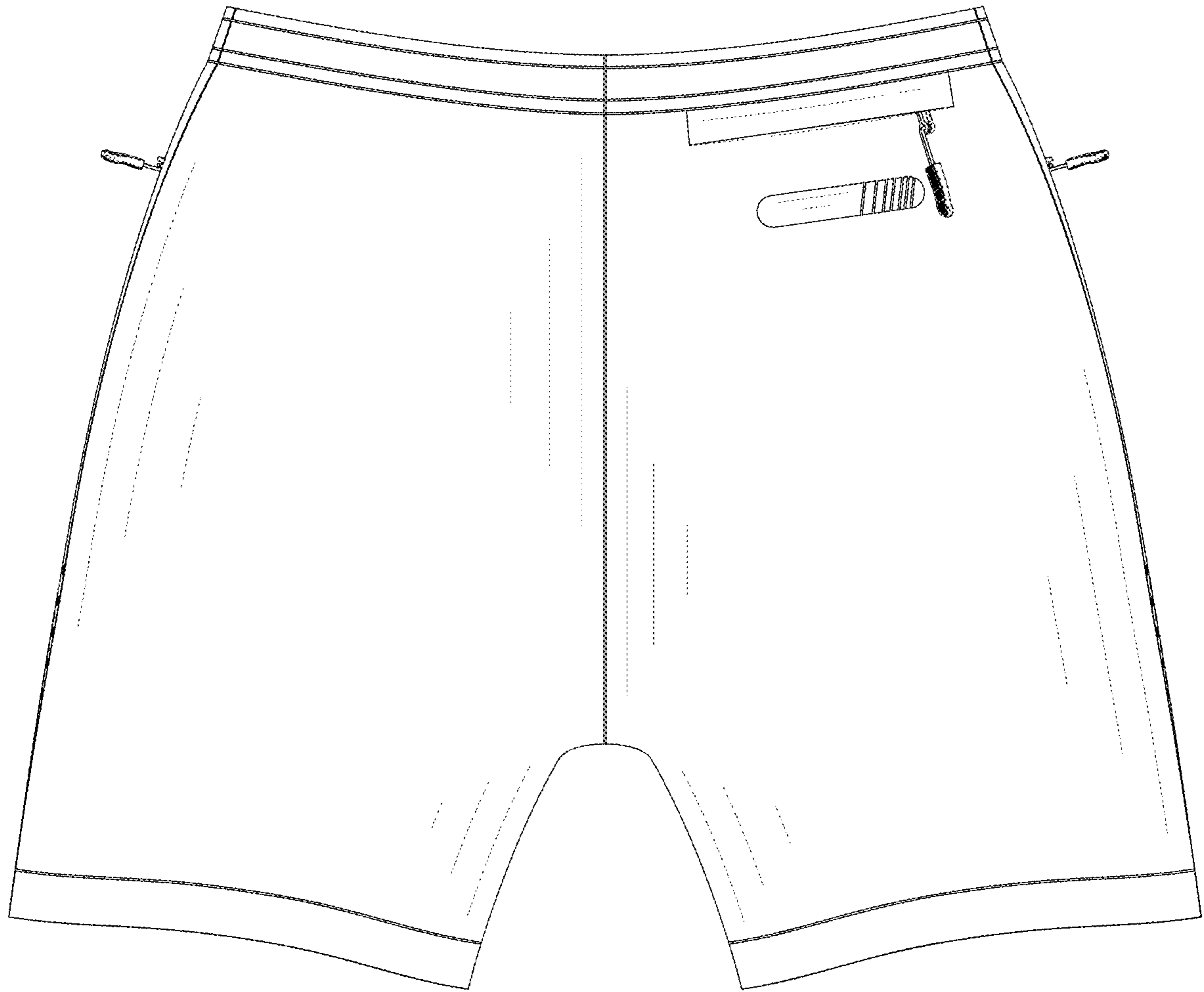

FIG. 4

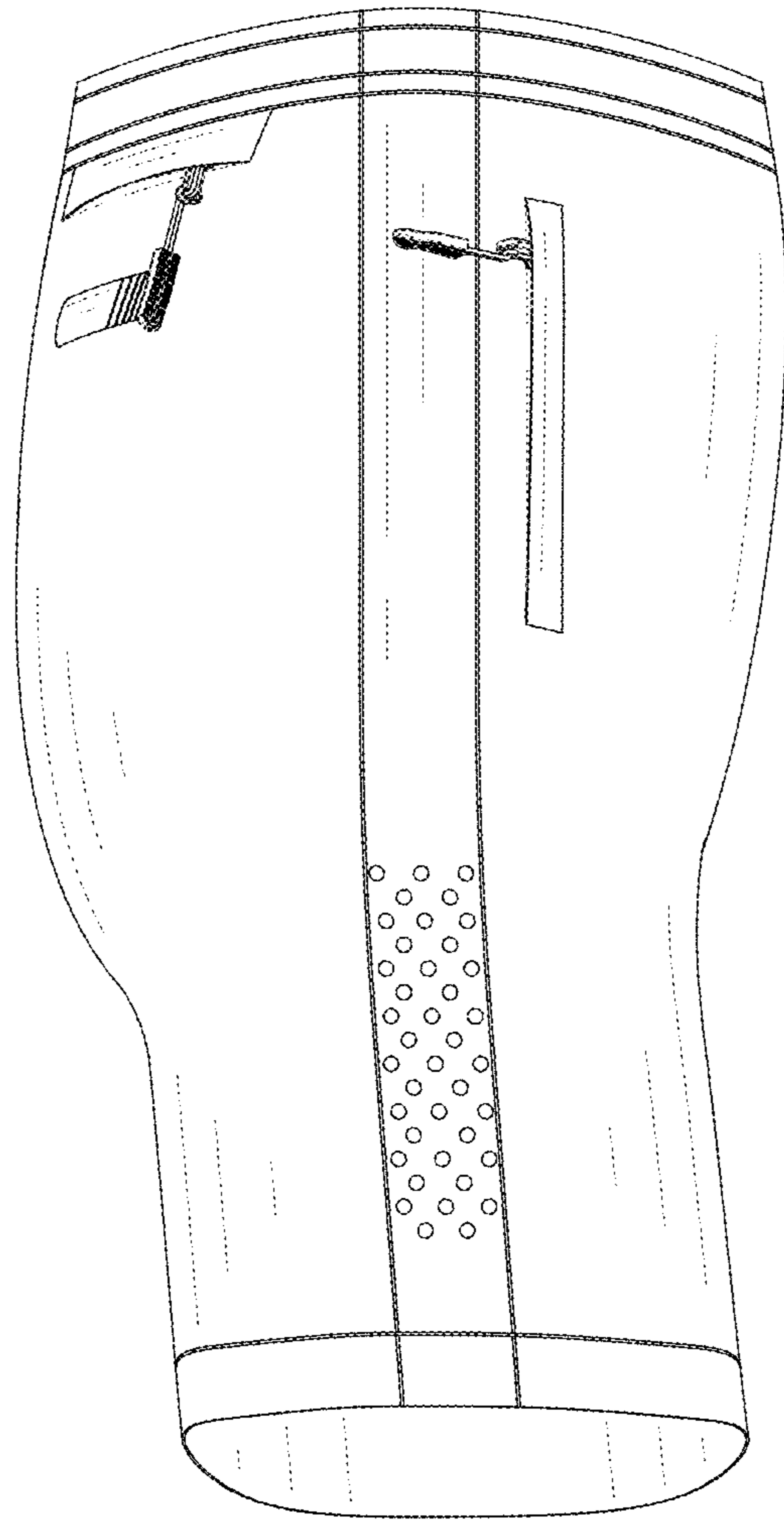

FIG. 5

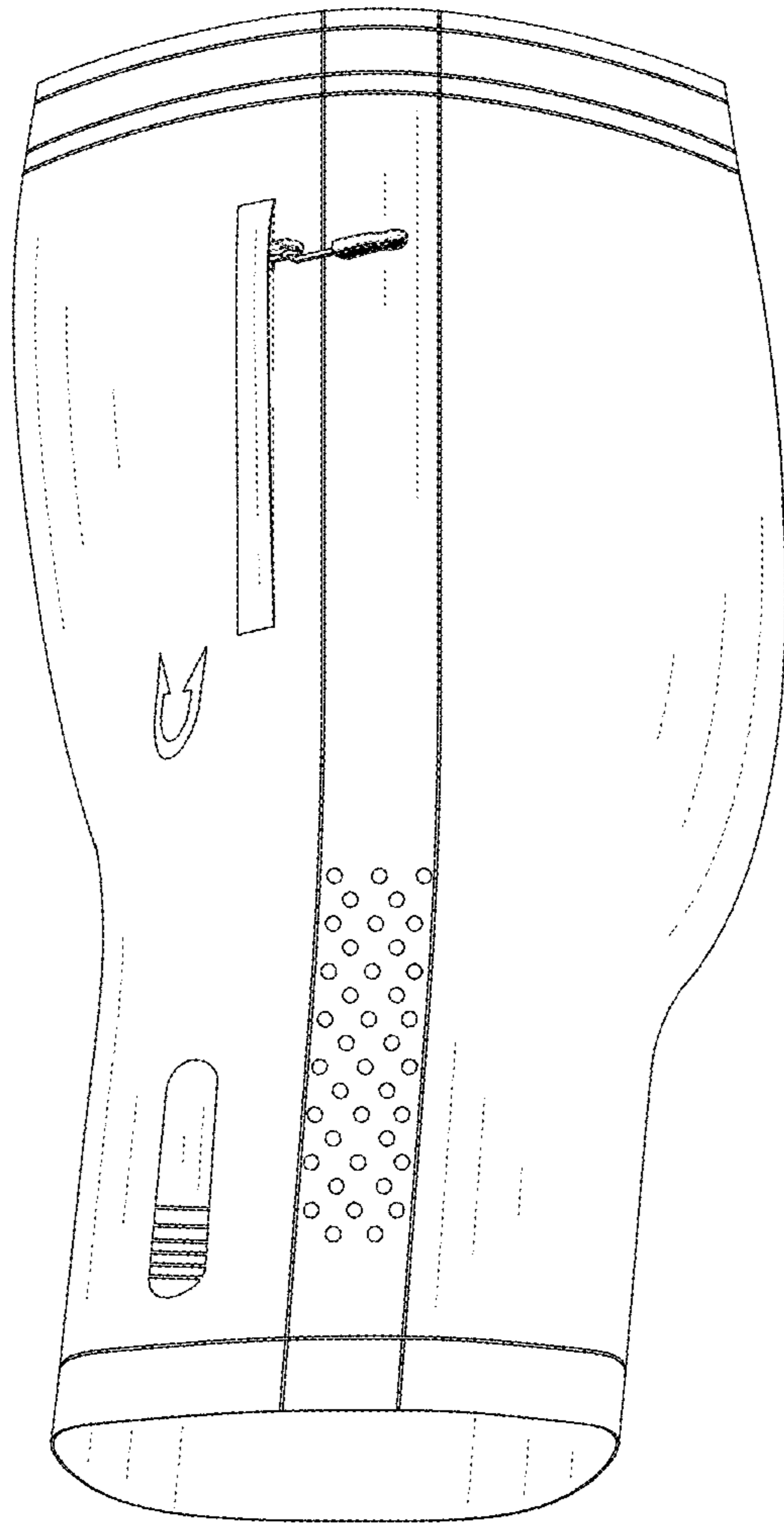

FIG. 6

FIG.11

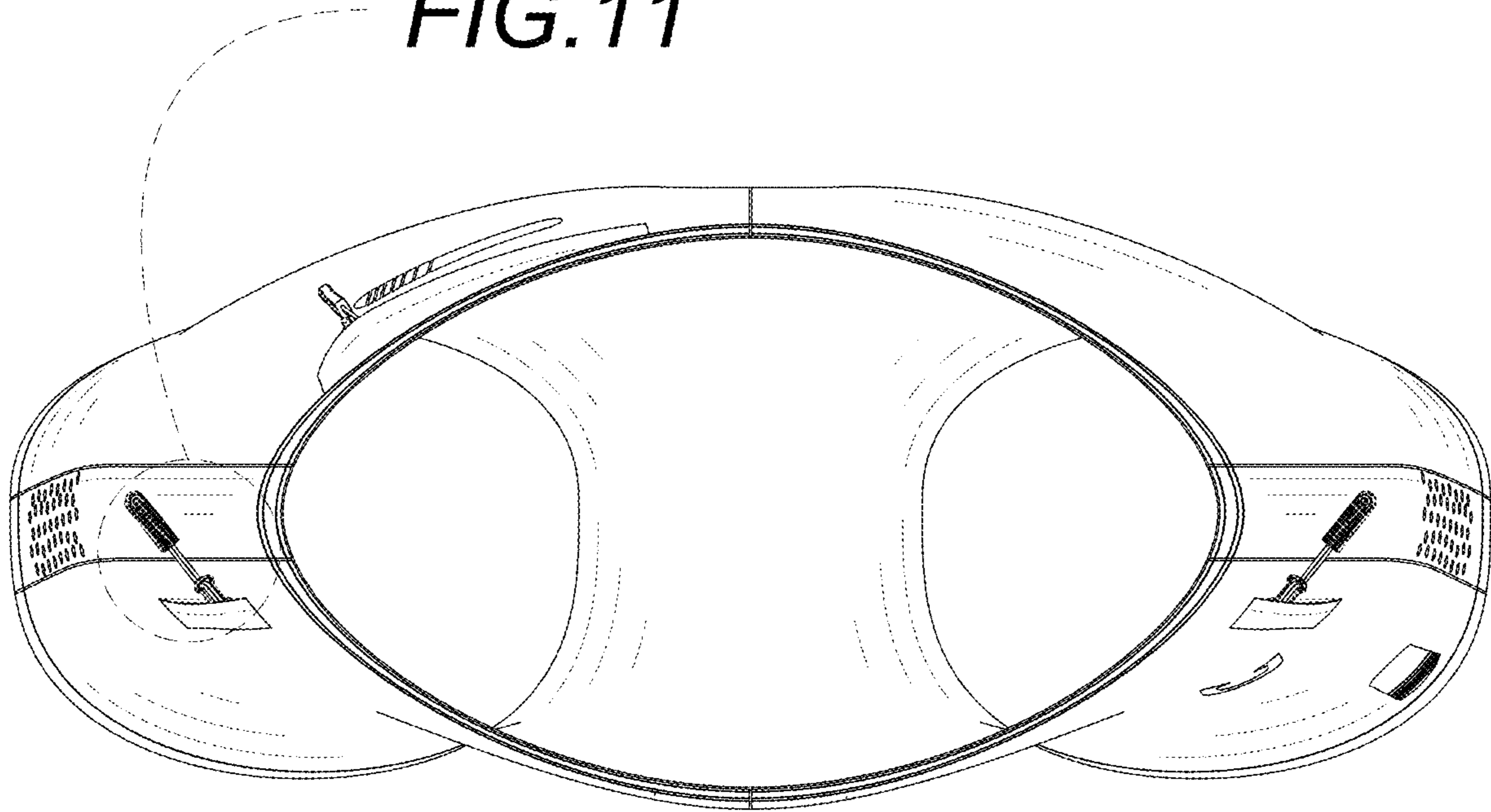

FIG.7

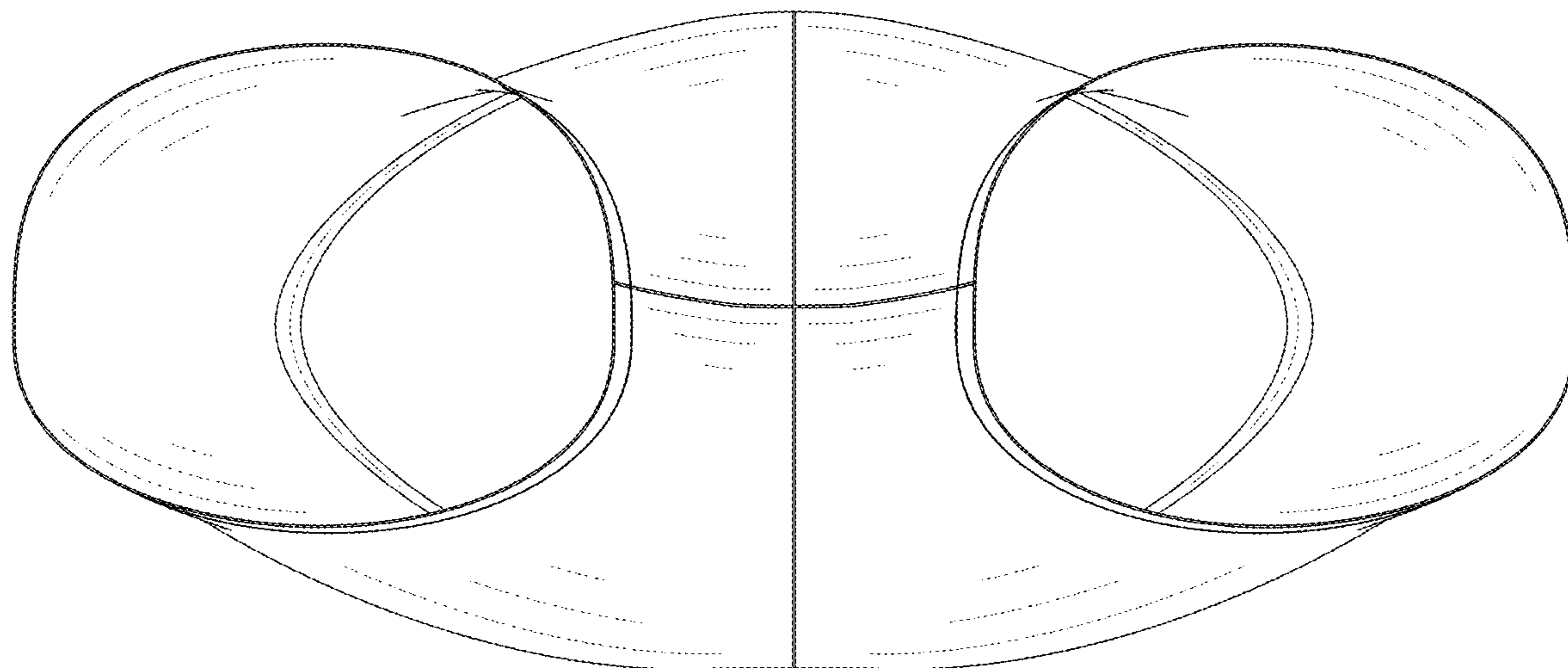

FIG. 8

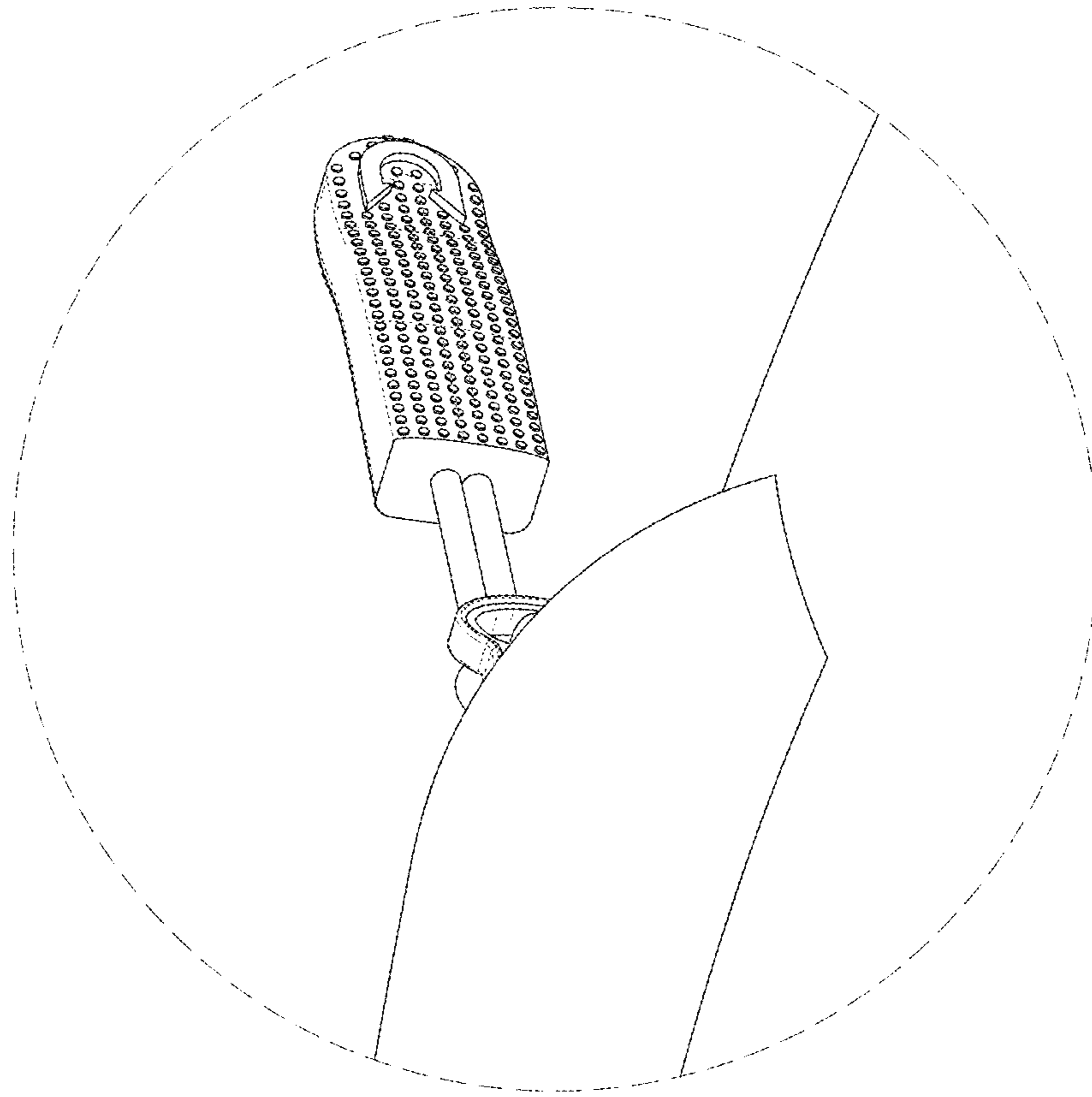

FIG. 9

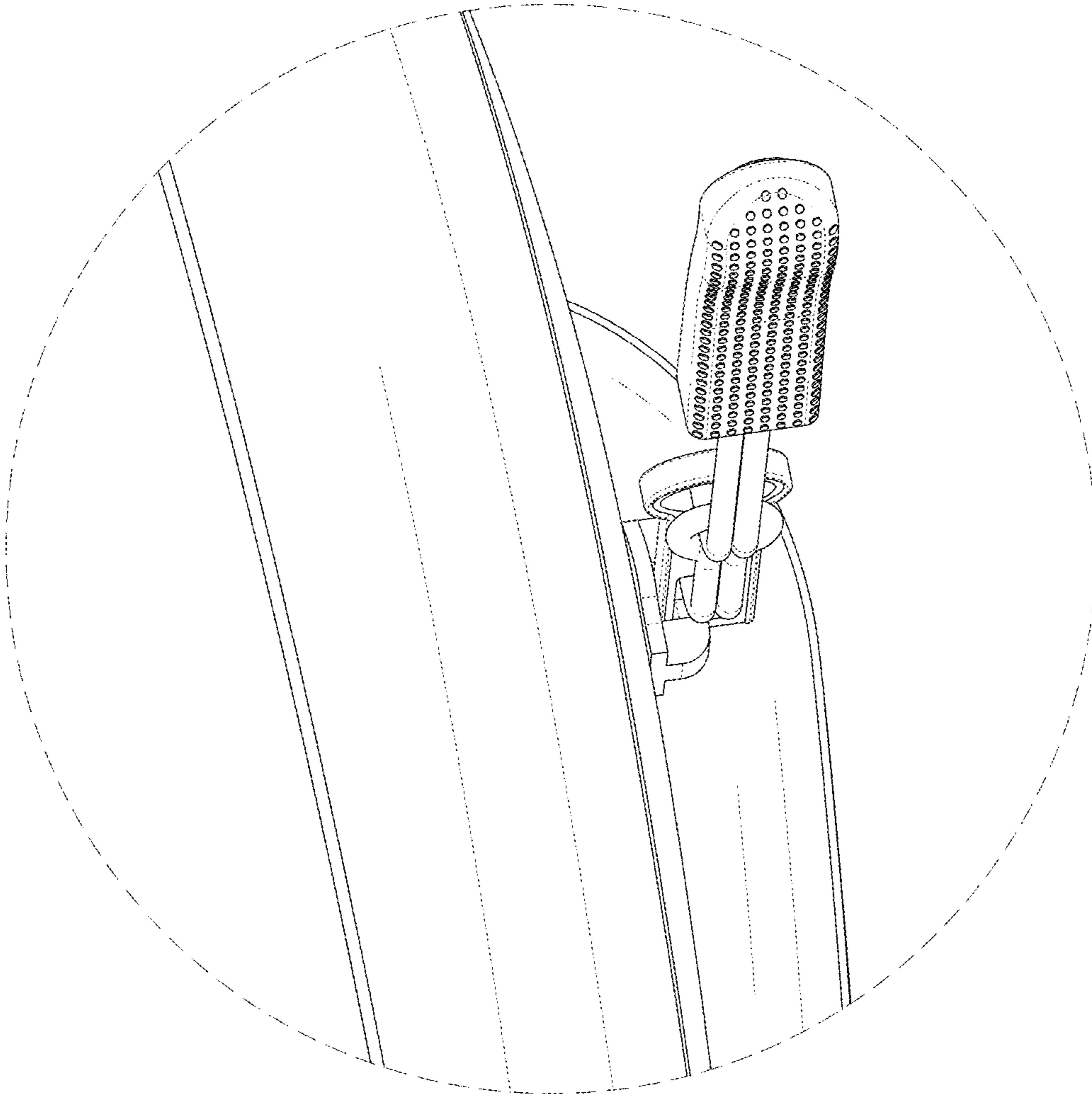

FIG. 10

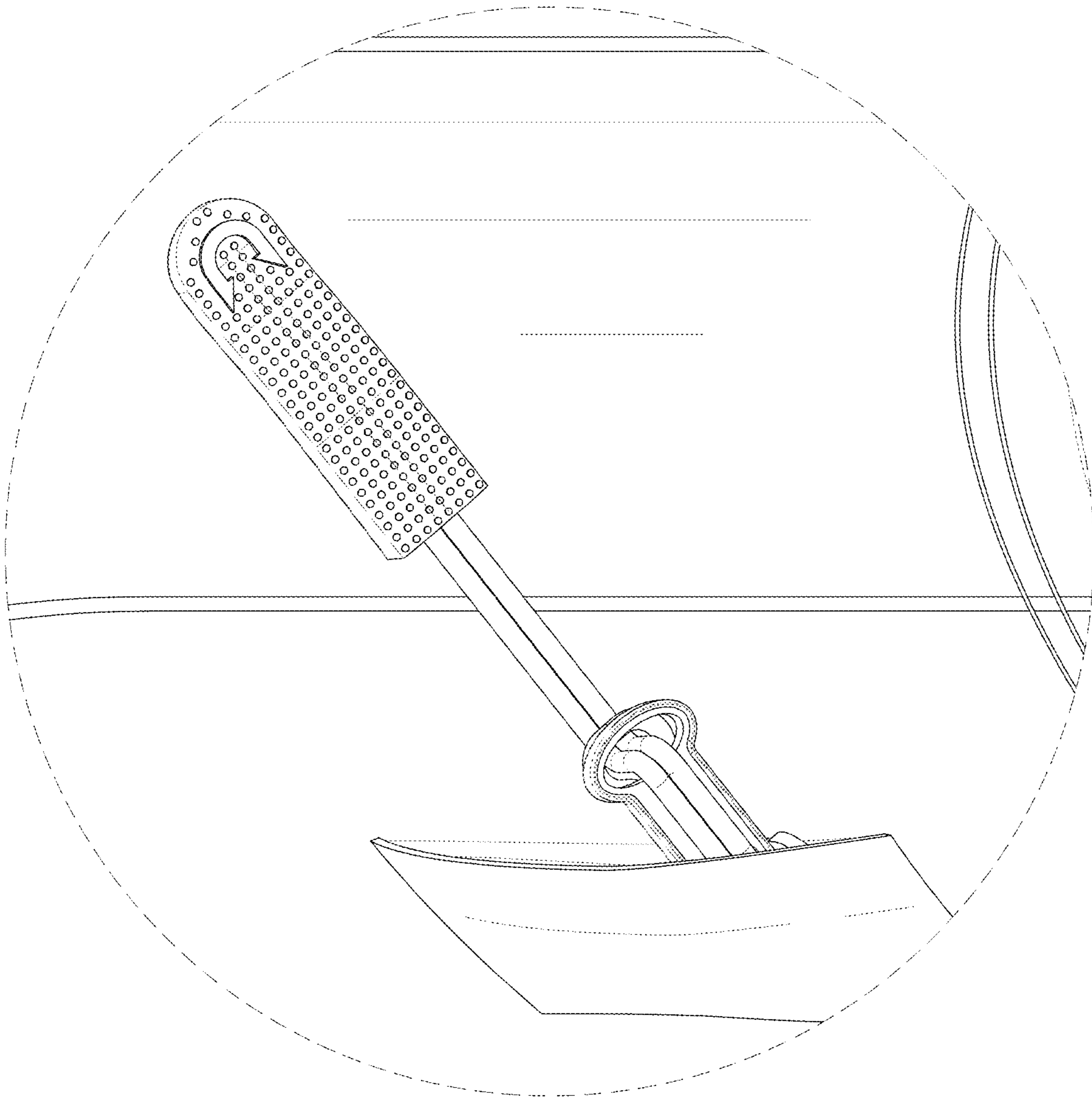

FIG. 11