



US00D968748S

(12) **United States Design Patent**  
**van Eyk et al.**

(10) **Patent No.:** **US D968,748 S**

(45) **Date of Patent:** **\*\* Nov. 8, 2022**

(54) **KABOB PET TREAT**

(71) Applicant: **Spectrum Brands, Inc.**, Middleton, WI (US)

(72) Inventors: **Gregory van Eyk**, Christiansburg, VA (US); **Tiffany Dawn Potter**, Pearisburg, VA (US); **Victoria Gray Kendrick**, Boones Mill, VA (US)

(73) Assignee: **Spectrum Brands, Inc.**, Middleton, WI (US)

(\*\*) Term: **15 Years**

(21) Appl. No.: **29/820,584**

(22) Filed: **Dec. 22, 2021**

**Related U.S. Application Data**

(60) Continuation of application No. 29/788,781, filed on Jul. 27, 2021, which is a division of application No. (Continued)

(51) **LOC (13) Cl.** ..... **01-01**

(52) **U.S. Cl.**  
USPC ..... **D1/106**

(58) **Field of Classification Search**  
USPC ..... D1/100-130, 199; 426/5, 76, 87, 92, 94, 426/95, 99, 101, 103, 104, 108, 134,  
(Continued)

(56) **References Cited**

**U.S. PATENT DOCUMENTS**

1,778,485 A 1/1929 Davidson  
2,036,706 A 4/1936 Law  
(Continued)

**FOREIGN PATENT DOCUMENTS**

CN 2755968 Y 2/2006  
CN 201207894 Y 3/2009  
(Continued)

**OTHER PUBLICATIONS**

Valentina. "Ground Beef Kabobs." <https://valentinascorner.com/ground-beef-kabobs/>. Jul. 6, 2018. Web. Jul. 16, 2022. <<https://valentinascorner.com/ground-beef-kabobs/>>.\*

(Continued)

*Primary Examiner* — Katie Jane Stofko

(74) *Attorney, Agent, or Firm* — Merchant & Gould P.C.

(57) **CLAIM**

The ornamental design for a kabob pet treat, as shown and described.

**DESCRIPTION**

FIG. 1 is front, top and right side perspective view of a first embodiment of a kabob pet treat according to the new design;

FIG. 2 is a back, bottom and left side perspective view thereof;

FIG. 3 is a front elevation view thereof;

FIG. 4 is a back elevation view thereof;

FIG. 5 is a right side elevation view thereof;

FIG. 6 is a left side elevation view thereof;

FIG. 7 is a top plan view thereof;

FIG. 8 is a bottom plan view thereof;

FIG. 9 is front, top and right side perspective view of a second embodiment of a kabob pet treat according to the new design;

FIG. 10 is a back, bottom and left side perspective view thereof;

FIG. 11 is a front elevation view thereof;

FIG. 12 is a back elevation view thereof;

FIG. 13 is a right side elevation view thereof;

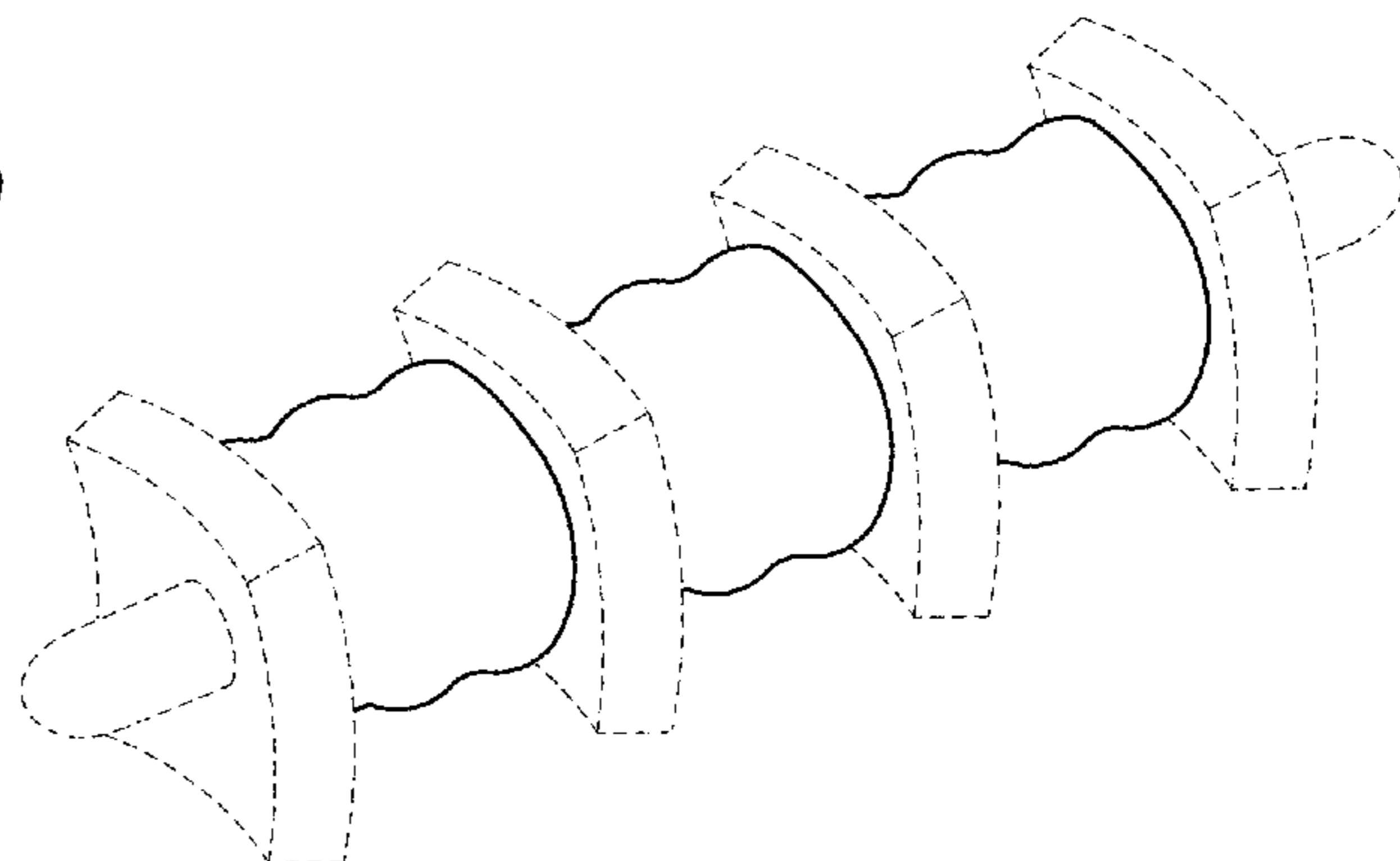
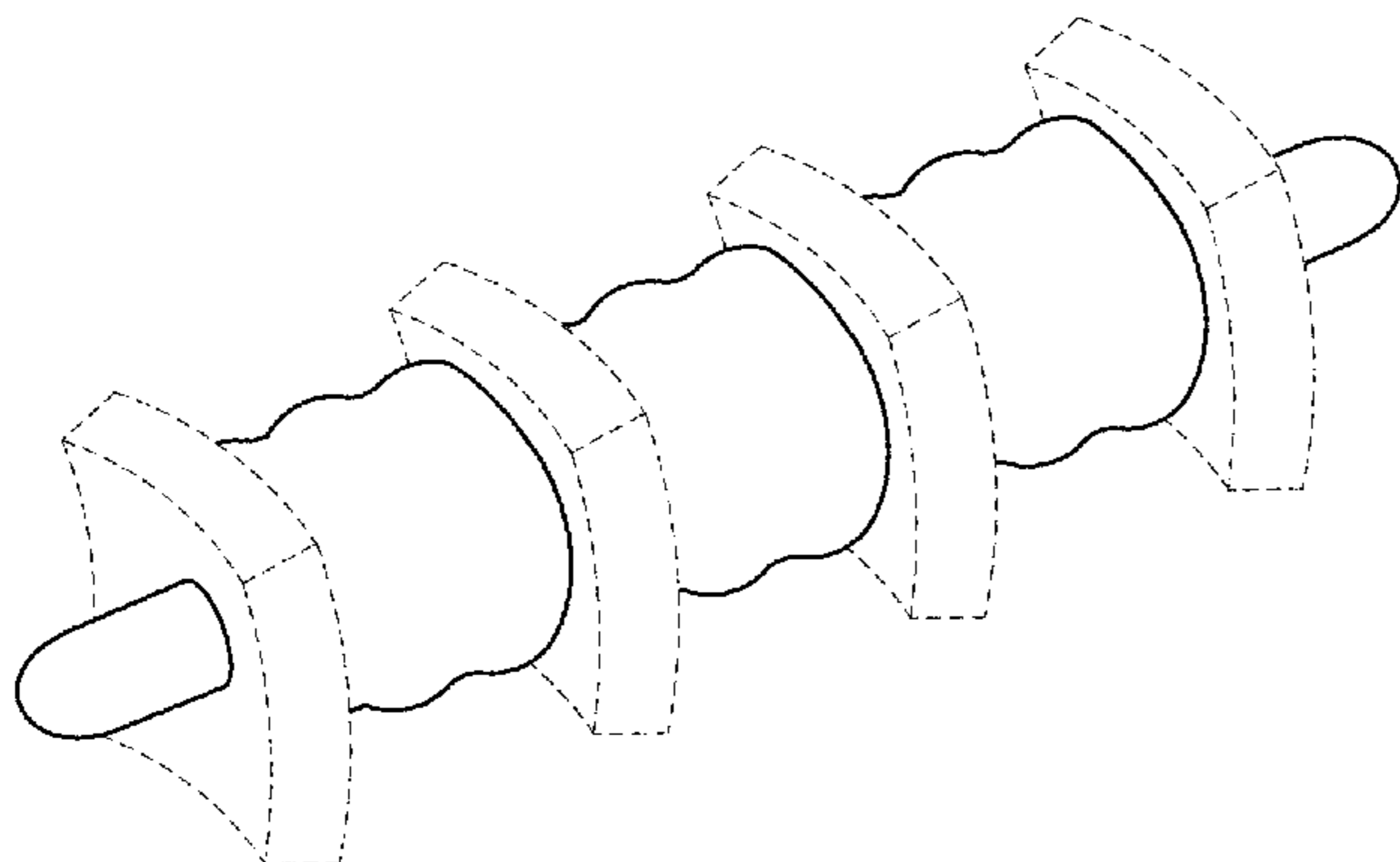
FIG. 14 is a left side elevation view thereof;

FIG. 15 is a top plan view thereof; and,

FIG. 16 is a bottom plan view thereof.

The broken lines shown FIGS. 1-16 illustrate portions of the pet treat that form no part of the claimed design.

**1 Claim, 8 Drawing Sheets**



**Related U.S. Application Data**

29/733,294, filed on Apr. 30, 2020, now Pat. No. Des. 929,072.

(58) **Field of Classification Search**

USPC ..... 426/138-139, 143, 144, 279, 282, 283, 426/391, 514, 549, 559, 560, 660, 808; D9/439, 669; D24/130; D6/597, 598, D6/601; D21/488-490, 493, 680; D23/366, 386, 415; 239/44; D8/83; D30/160

CPC . A23G 3/50; A23G 3/54; A23G 9/282; A23G 3/28; A23J 3/26; A23L 1/0067

See application file for complete search history.

(56) **References Cited**

U.S. PATENT DOCUMENTS

2,116,310	A	5/1938	Harvey
2,185,547	A	1/1940	Fowler
D133,869	S	9/1942	Donahue
2,469,589	A	5/1949	Barricini
D174,999	S	6/1955	Schall
2,988,045	A	6/1961	Fisher
3,858,495	A	1/1975	Gotwalt
3,939,761	A	2/1976	McGinty
4,902,519	A	2/1990	Ream et al.
4,924,811	A	5/1990	Axelrod
5,168,798	A	12/1992	Kristofich et al.
5,193,443	A	3/1993	Carney
5,296,209	A	3/1994	Simone et al.
5,532,014	A	7/1996	Kobussen et al.
D391,735	S	3/1998	Baker
D392,435	S	3/1998	Mocking et al.
D408,948	S	4/1999	Huettner et al.
D415,803	S	10/1999	Cousins
6,042,873	A	3/2000	Lawson
6,054,159	A	4/2000	Manzone
D427,391	S	6/2000	Gill
6,113,956	A	9/2000	Bower
6,159,508	A	12/2000	Wolf et al.
6,228,402	B1	5/2001	Wolf et al.
6,277,420	B1	8/2001	Andersen et al.
6,455,083	B1	9/2002	Wang
6,601,539	B1	8/2003	Snook
D485,046	S	1/2004	Hague
D497,457	S	10/2004	Willinger
6,827,041	B2	12/2004	Hague et al.
D503,507	S	4/2005	Jia et al.
D505,533	S	5/2005	Jia et al.
D508,762	S	8/2005	Jia et al.
D522,711	S	6/2006	Nakata
D525,397	S	7/2006	Wang
D569,077	S	5/2008	Axelrod
D582,628	S	12/2008	Mammana
7,485,330	B2	2/2009	Anderson et al.
D594,182	S	6/2009	Hague
D626,706	S	11/2010	Ragonetti
D645,640	S	9/2011	Mingyun et al.
D649,736	S	12/2011	Cheung
D650,137	S	12/2011	Byrne
D650,146	S	12/2011	Cheung
D651,771	S	1/2012	Shanghai
D655,888	S	3/2012	Mingyun et al.
D661,458	S	6/2012	Mingyun et al.
D661,850	S	6/2012	Byrne
D672,099	S	12/2012	Simms et al.
8,491,950	B2	7/2013	Grammer et al.
D696,836	S	1/2014	Chen
D706,091	S	6/2014	DiCosimo
D708,417	S	7/2014	Allen
D708,418	S	7/2014	Allen
D708,818	S	7/2014	Axelrod et al.
D713,991	S	9/2014	Escalante, III
D721,210	S	1/2015	Diskin

D726,991	S	4/2015	Albuja
9,010,821	B2	4/2015	Stern
9,044,039	B2	6/2015	Xu
D741,555	S	10/2015	Byrne
D743,639	S	11/2015	Byrne
D744,175	S	11/2015	Byrne
D747,841	S	1/2016	Petersen
D752,841	S	4/2016	Neely et al.
D759,341	S	6/2016	Templeman et al.
D761,496	S	7/2016	Byrne
D762,042	S	7/2016	Osenga
D778,001	S	1/2017	Byrne
D781,525	S	3/2017	Kreamer
D831,297	S	10/2018	Kreamer
D836,880	S	1/2019	Kreamer
2002/0168452	A1	11/2002	Best et al.
2003/0106500	A1	6/2003	Kirch
2003/0215547	A1	11/2003	Leyh, Jr.
2004/0005392	A1	1/2004	Filipi et al.
2004/0028783	A1	2/2004	Fullwood et al.
2004/0126462	A1	7/2004	Tepper et al.
2004/0213876	A1	10/2004	Olson
2004/0219260	A1	11/2004	Anderson et al.
2005/0069609	A1	3/2005	Straus et al.
2005/0147719	A1	7/2005	Hill et al.
2006/0134278	A1	6/2006	Miller
2006/0240175	A1	10/2006	Weiss et al.
2007/0193531	A1	8/2007	Anderson et al.
2007/0218171	A1	9/2007	Mehrle et al.
2007/0264415	A1	11/2007	Axelrod et al.
2008/0014311	A1	1/2008	Tepper et al.
2008/0050477	A1	2/2008	Valles Luque
2008/0145485	A1	6/2008	Tepper et al.
2008/0175962	A1	7/2008	Grammer et al.
2008/0193607	A1	8/2008	Tepper et al.
2009/0148567	A1	6/2009	Philips
2009/0235872	A1	9/2009	Filipi et al.
2009/0241784	A1	10/2009	Colby
2009/0269449	A1	10/2009	Taguchi et al.
2009/0297666	A1	12/2009	Neijnens
2010/0055254	A1	3/2010	Hu
2010/0062111	A1	3/2010	Langford
2010/0124588	A1	5/2010	Bhatnagar
2010/0173045	A1	7/2010	Cervantes
2010/0303970	A1	12/2010	Grammer et al.
2010/0304002	A1	12/2010	Grammer et al.
2012/0234259	A1	9/2012	Xu
2013/0209616	A1	8/2013	Bottini et al.
2013/0266696	A1	10/2013	Shrestha et al.
2013/0266712	A1	10/2013	Shrestha
2013/0295235	A1	11/2013	Albuja et al.
2013/0309359	A1	11/2013	Langford
2014/0134300	A1	5/2014	Bramley et al.
2014/0186276	A1	7/2014	Mahe
2014/0335223	A1	11/2014	Grammer et al.
2015/0090192	A1	4/2015	Powers et al.
2015/0181839	A1	7/2015	Baikie
2015/0246066	A1	9/2015	Nelson
2016/0143320	A1	5/2016	Mahe et al.
2017/0181449	A1	6/2017	Harbour

FOREIGN PATENT DOCUMENTS

DE	10 2015 107 453	A1	8/2016
WO	2004/062522	A2	7/2004
WO	2008/003140	A1	1/2008

OTHER PUBLICATIONS

Blonde Chicken, "Fluffy Cheesy Weiner Kebab," Instructable, (Aug. 11, 2010), Web. Jul. 27, 2018, <<https://www.instructables.com/id/Fluffy-Cheesy-Weiner-Kabobs/>>.

Dingo, Porkie Roll Pork and Porkhide Dog Chew Sticks, <http://www.dingobrand.com/Products/Rawhide-sticks-for-dogs/Porkie-porkhide-dog-chew-sticks.aspx>, printed Decembers, 2016.

Dingo, Dynostix Rawhide Chew Sticks, <http://www.dingobrand.com/Products/Rawhide-sticks-for-dogs/Copy-of-Dynostix-rawhide-chew-sticks.aspx>, printed Dec. 8, 2016.

(56)

**References Cited**

## OTHER PUBLICATIONS

Dingo, Twist Sticks Chicken Rawhide Twists, <http://www.dingobrand.com/Products/Rawhide-sticks-for-dogs/Twist-Sticks-Chicken-50-Pack.aspx>, printed Dec. 8, 2016.

Dingo, Tartar Control Dental Sticks for Dogs, <http://www.dingobrand.com/Products/Dog-tartar-control-and-removal/How-to-remove-dog-tartar-dental-sticks.aspx>, printed Dec. 8, 2016.

Elfenbein. "Cooking for Dogs—Shish Kebabs." <http://twolittlecavaliers.com>, Jun. 10, 2012, 3 pages.

Elle, "Elle's Kitchen: Adana Kebab," American Homestead, <http://americanhomestead.blogspot.com/2012/06/elles-kitchen-adana-kebab.html>, 11 pages (Jun. 16, 2012).

Hair, Jaden. "Asian Steak Kabobs," Steamy Kitchen, <http://web.archive.org/web/20110717185015/http://steamykitchen.com/16839-asian-steak-kabobs-recipe.html#comments>, 21 pages (Jul. 15, 2011).

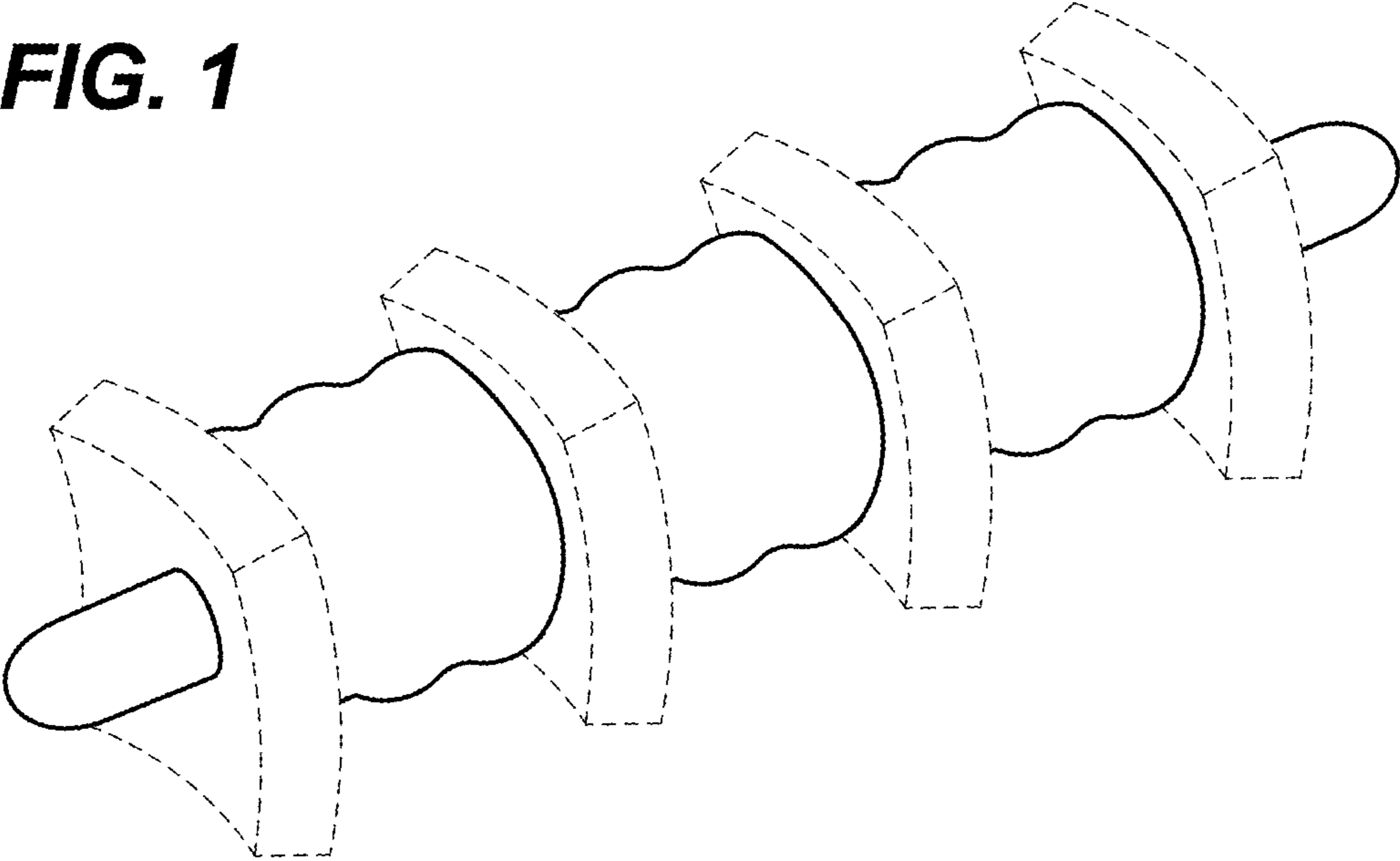
Sacco, Brooke Dowd. "Web's Tastiest Halloween Food, Marshmallow & Pretzel Bones" Kid Crave. (Oct. 22, 2012), Web. May 24, 2017, <<http://kidcrave.com/scoop/webs-tastiest-halloween-food/>>.

Unknown. "Griddled glazed vegetable kebabs." BBC Good Food, Jul. 2010, 3 pages retrieved from [www.bbcgoodfood.com/recipes/588651/griddled-glazed-vegetable-kebabs](http://www.bbcgoodfood.com/recipes/588651/griddled-glazed-vegetable-kebabs).

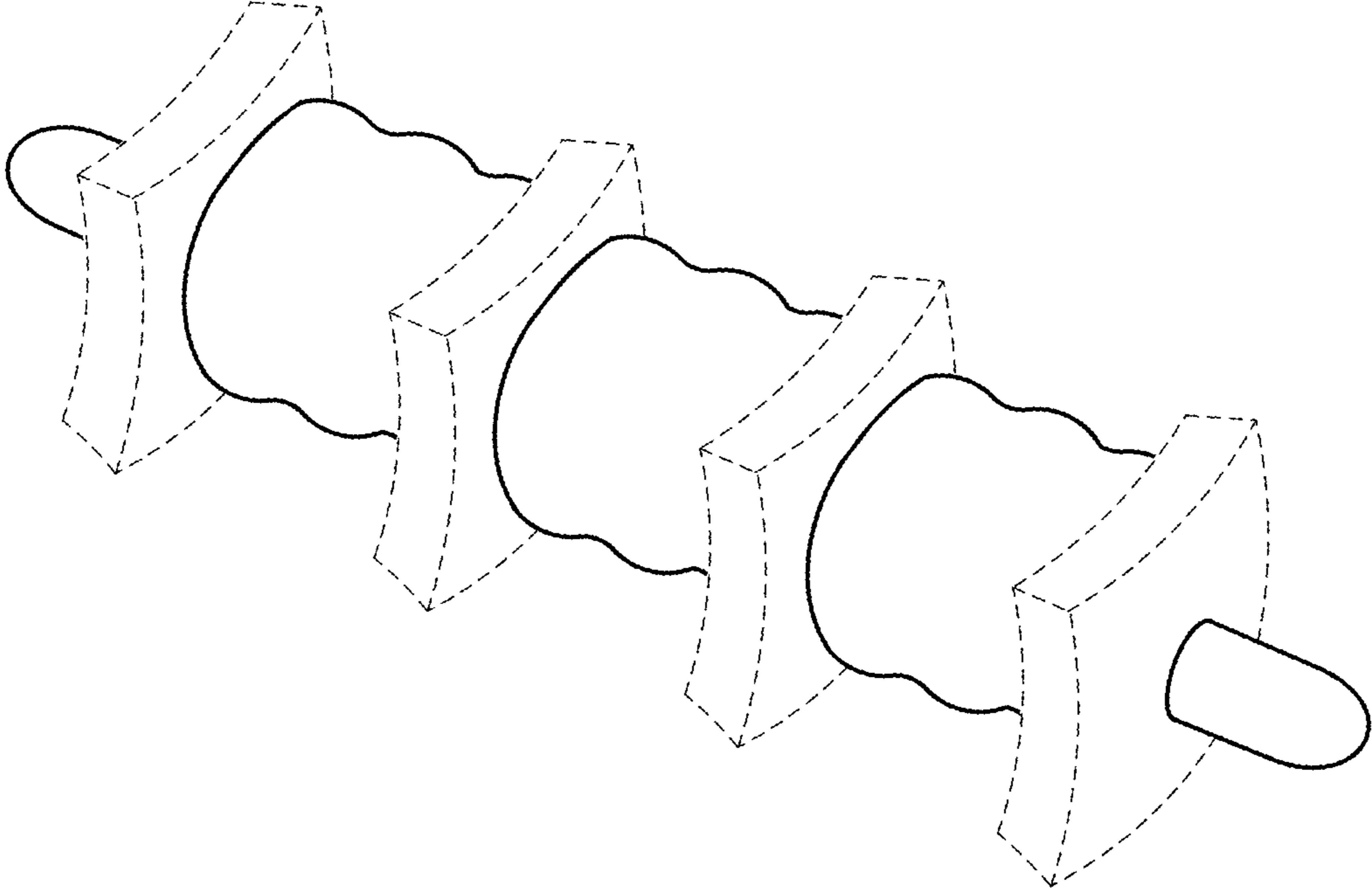
Bee. "Chicken Kebab Recipe." Rasa Malaysia. Mar. 27, 2009. Web. Oct. 24, 2016. <<https://rasamalaysia.com/chicken-kebab-recipe/>>.

\* cited by examiner

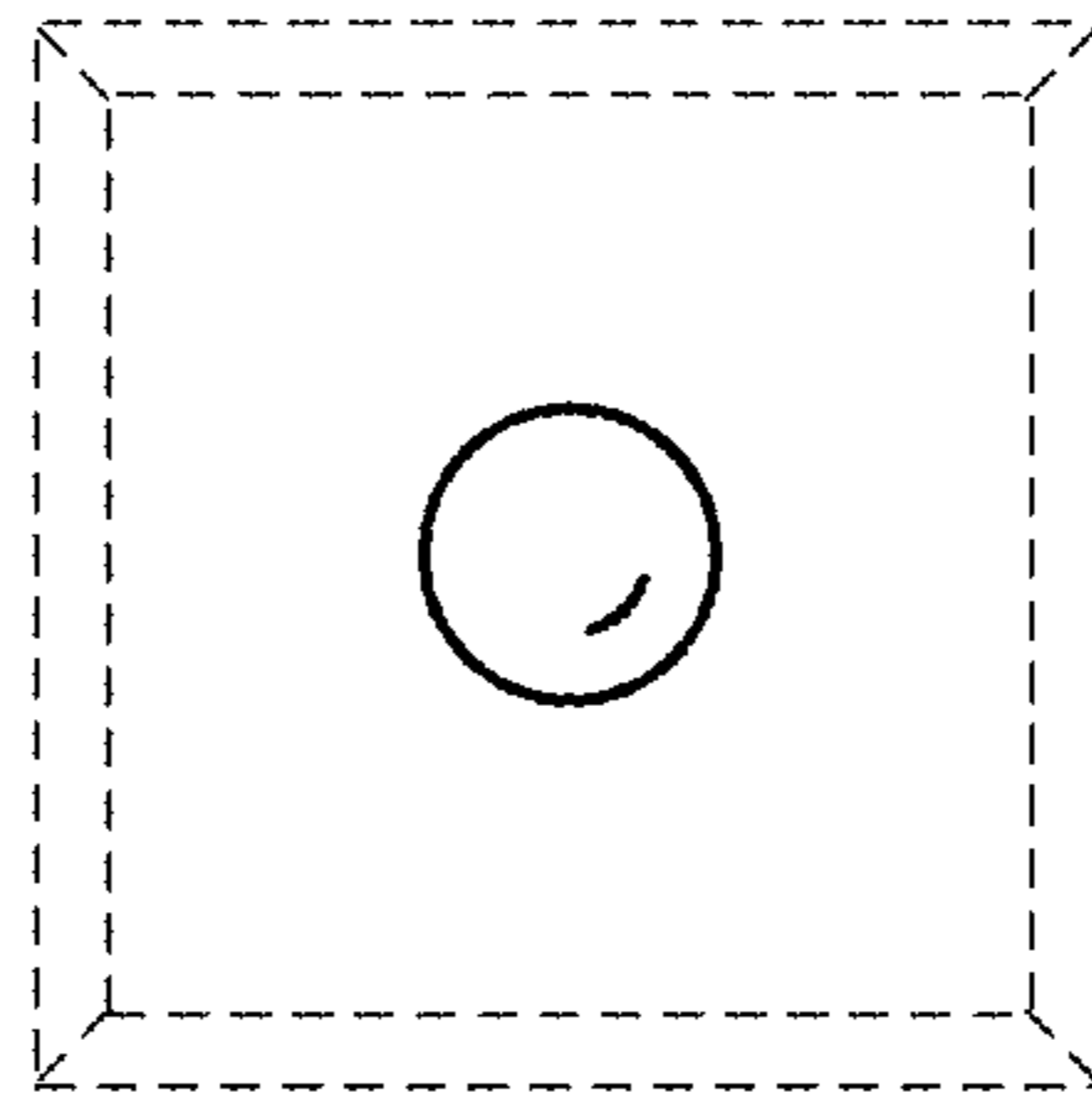
**FIG. 1**



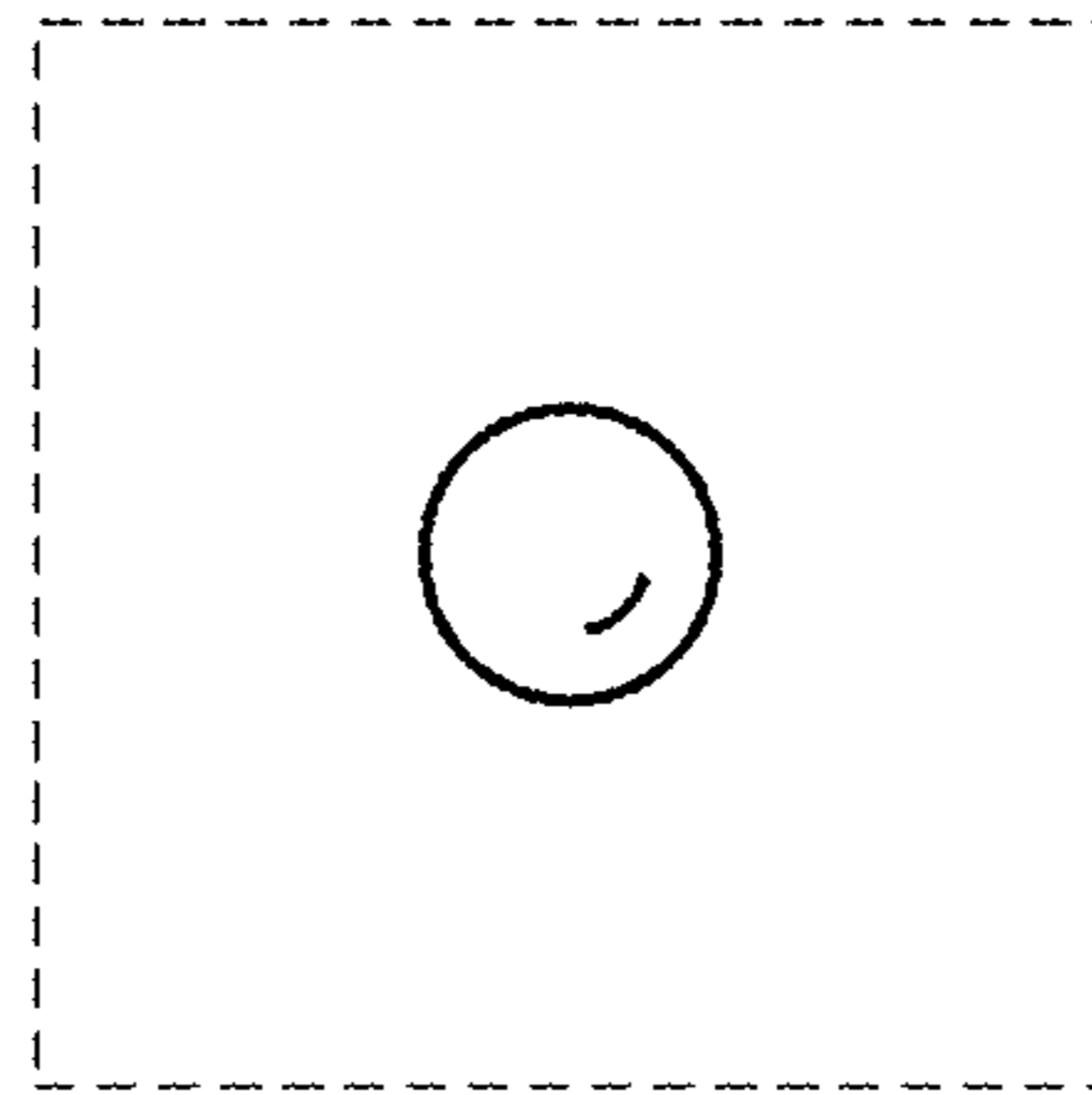
**FIG. 2**



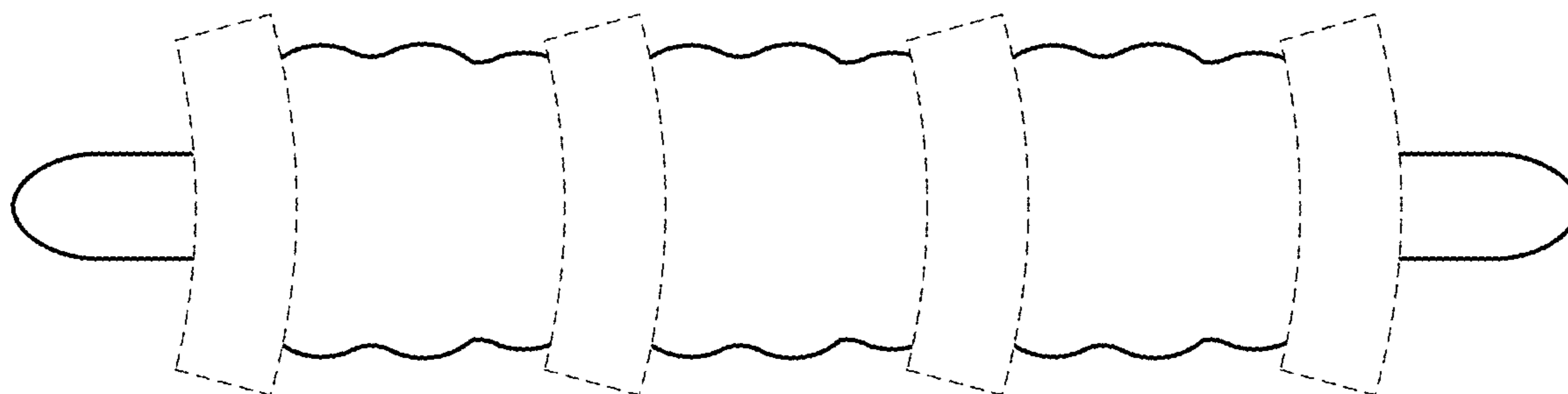
**FIG. 3**



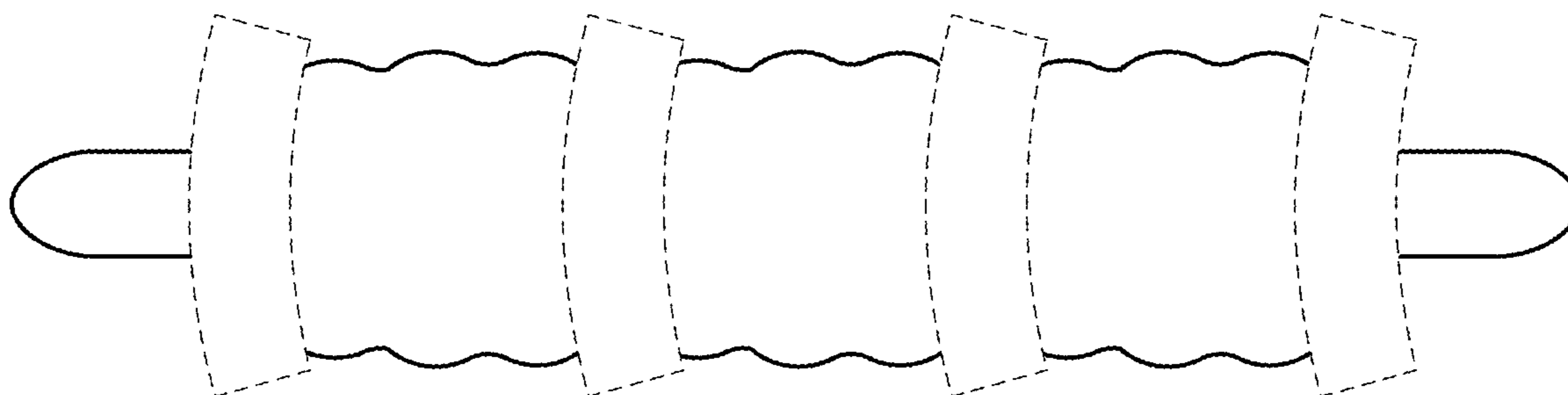
**FIG. 4**



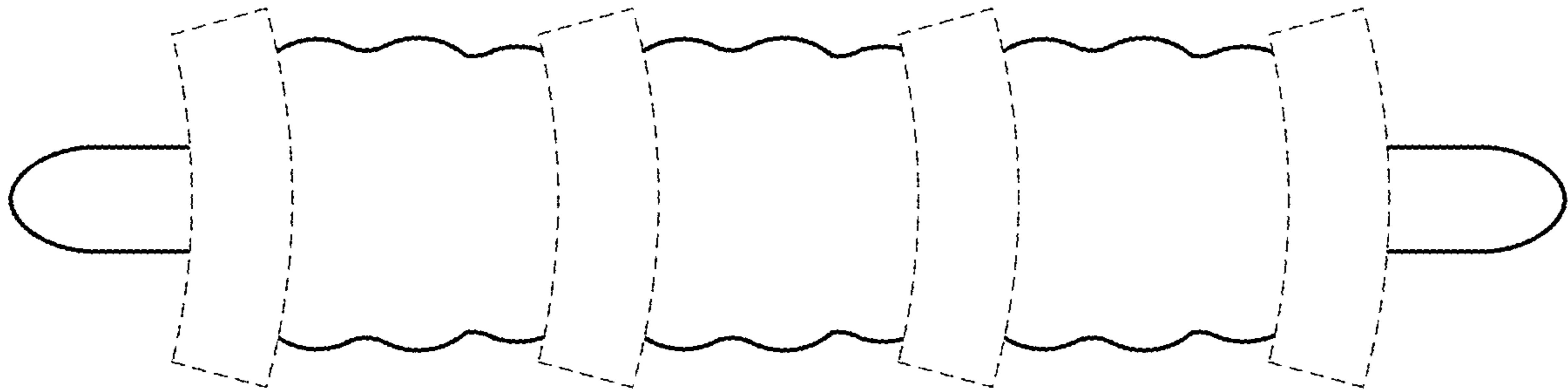
**FIG. 5**



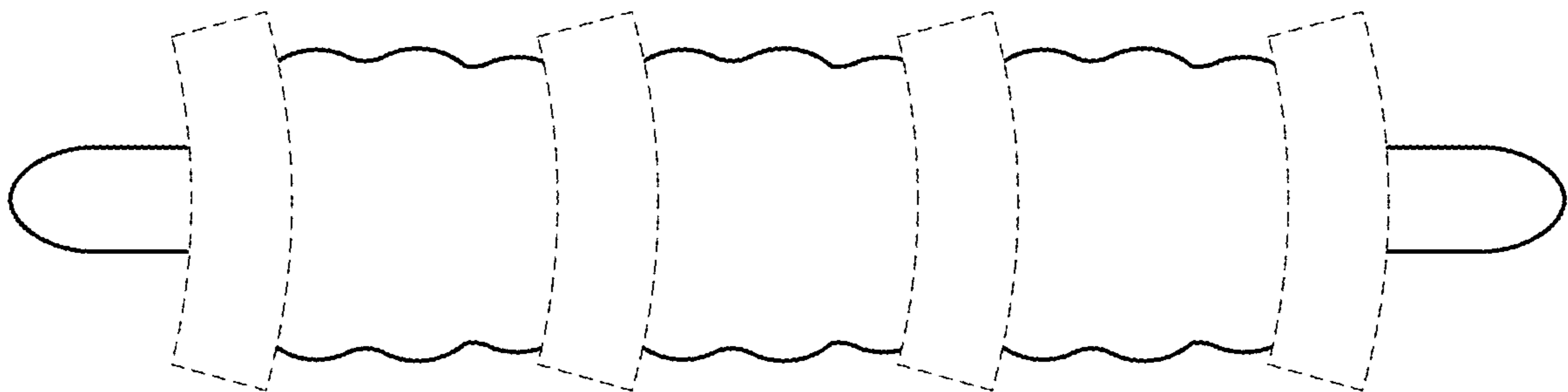
**FIG. 6**



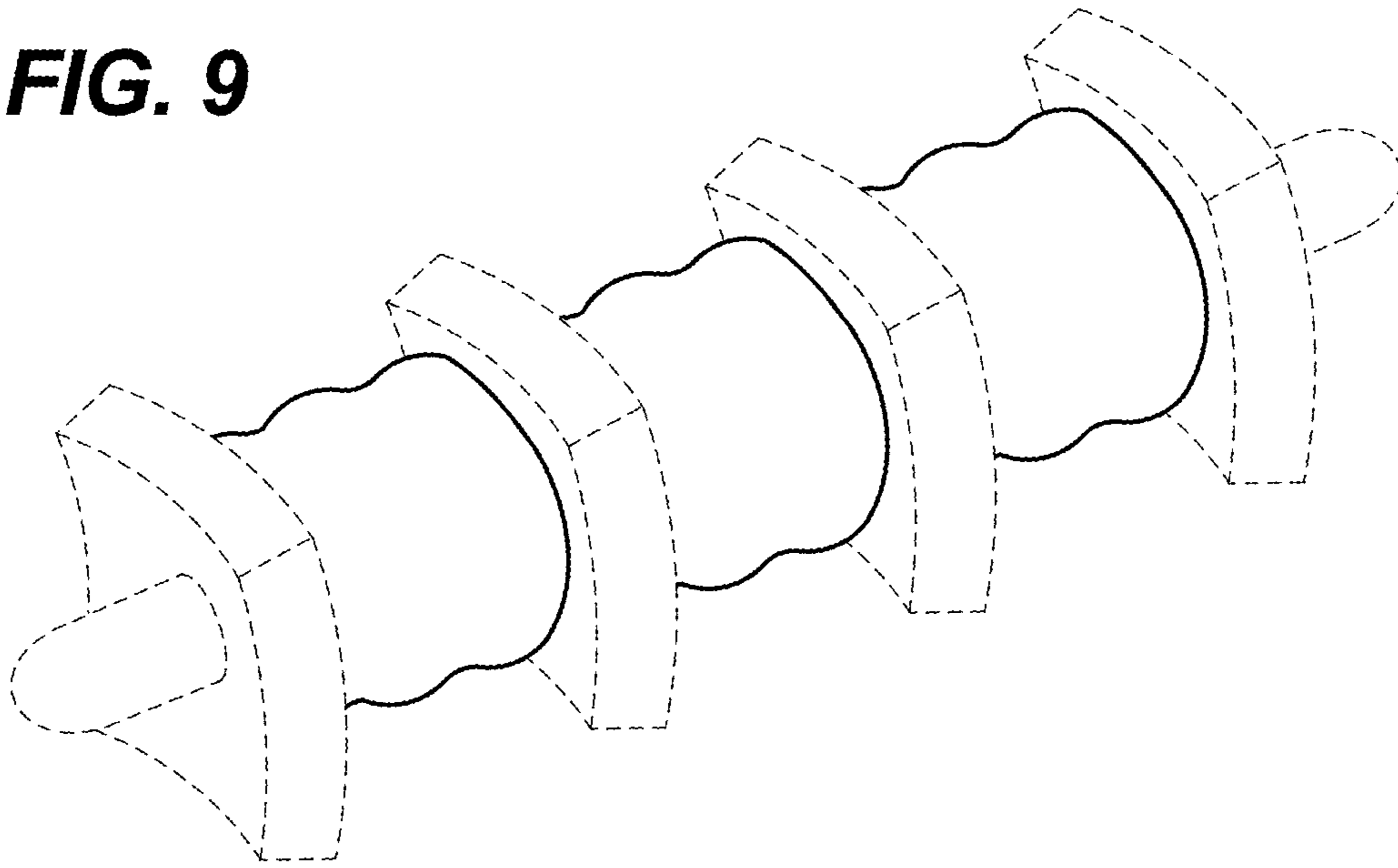
**FIG. 7**



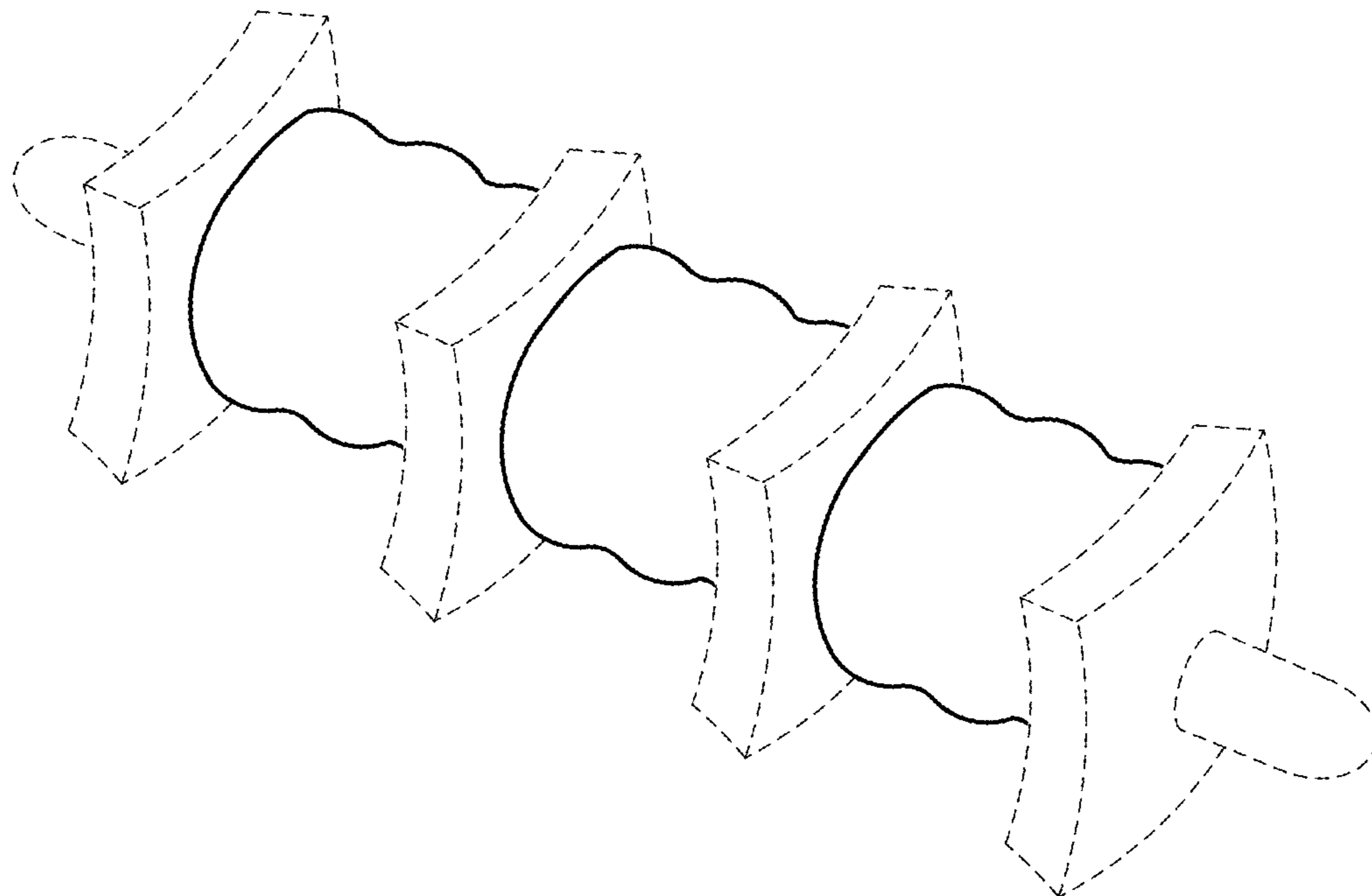
**FIG. 8**



**FIG. 9**

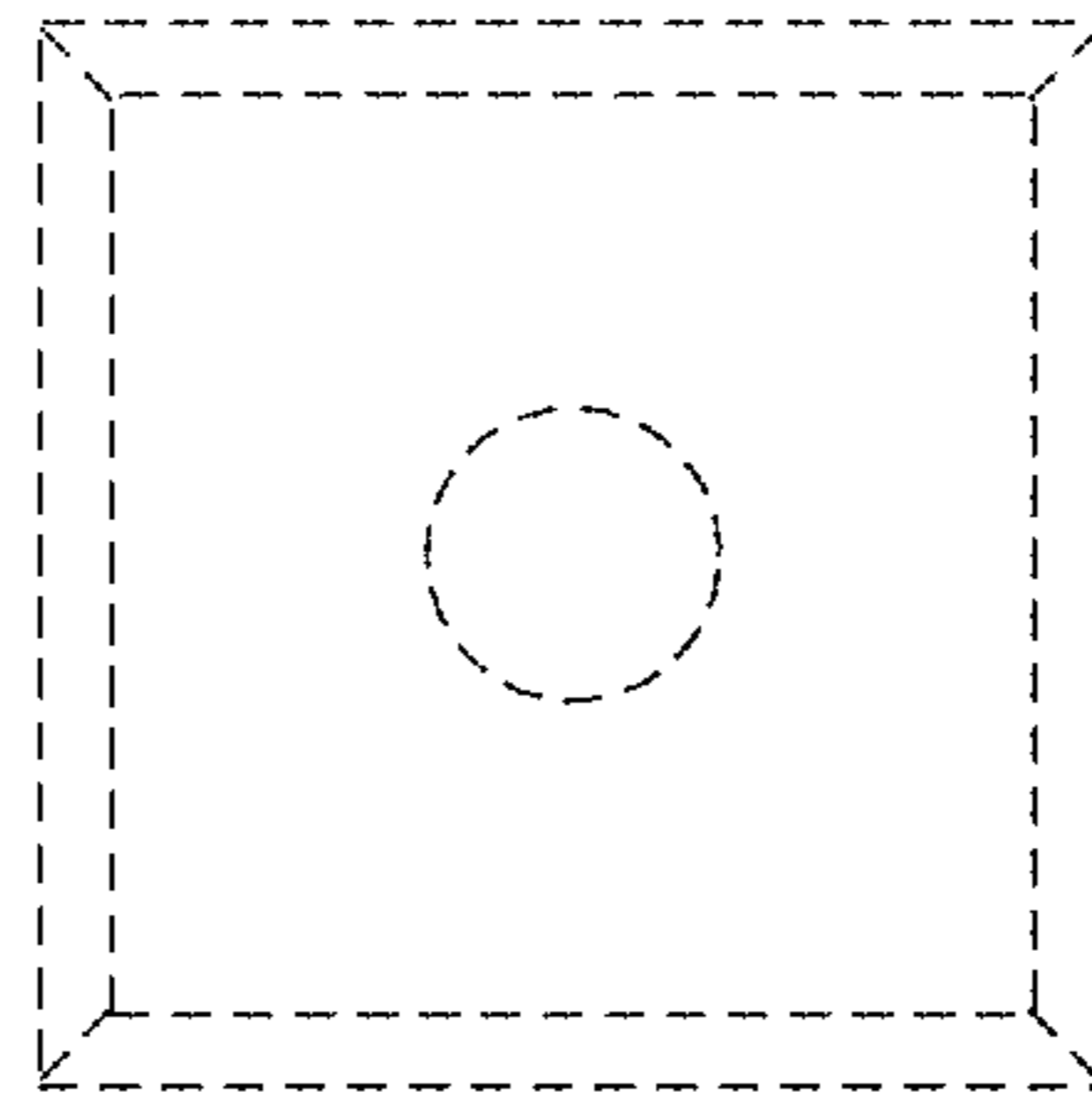


**FIG. 10**

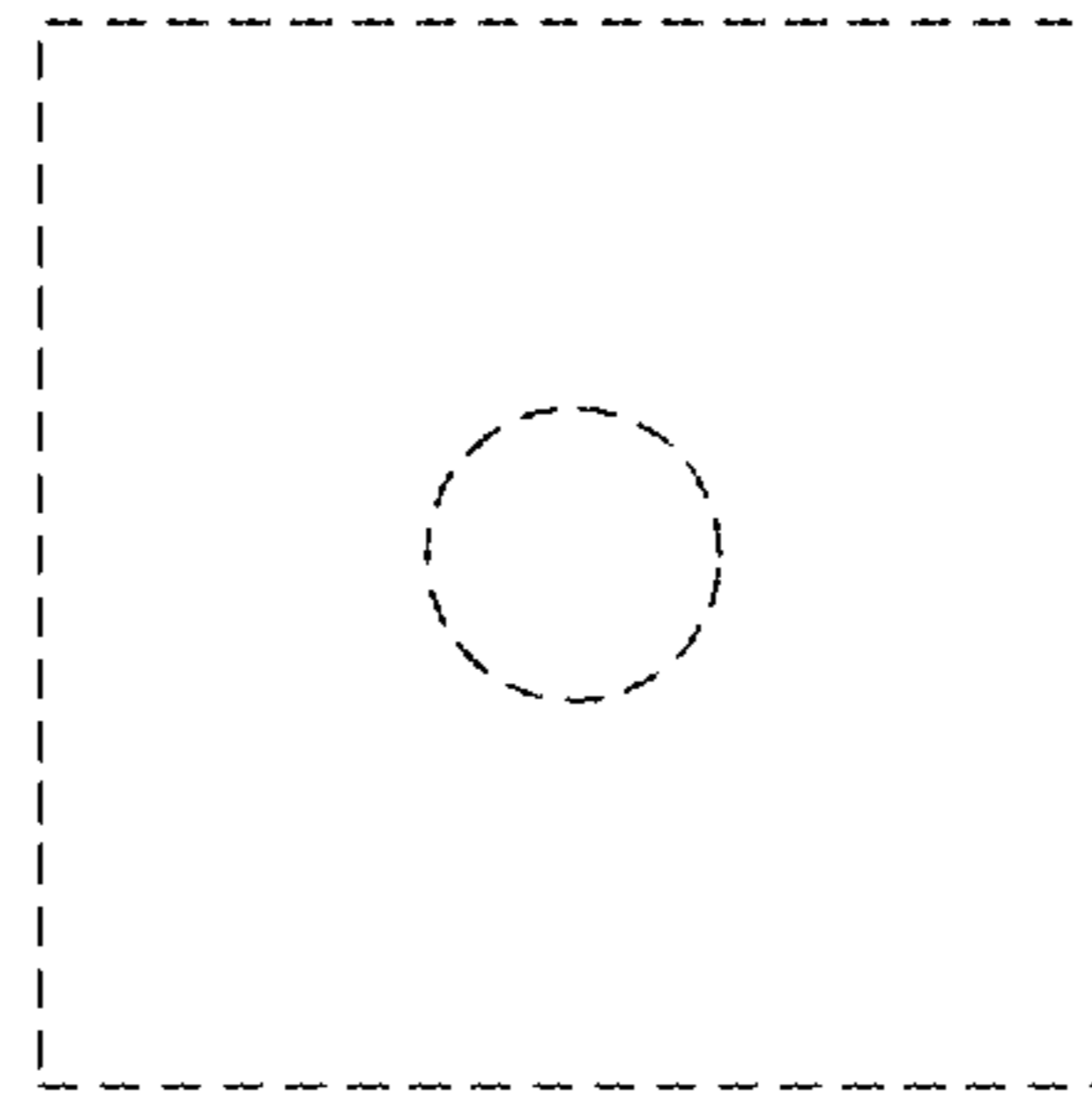




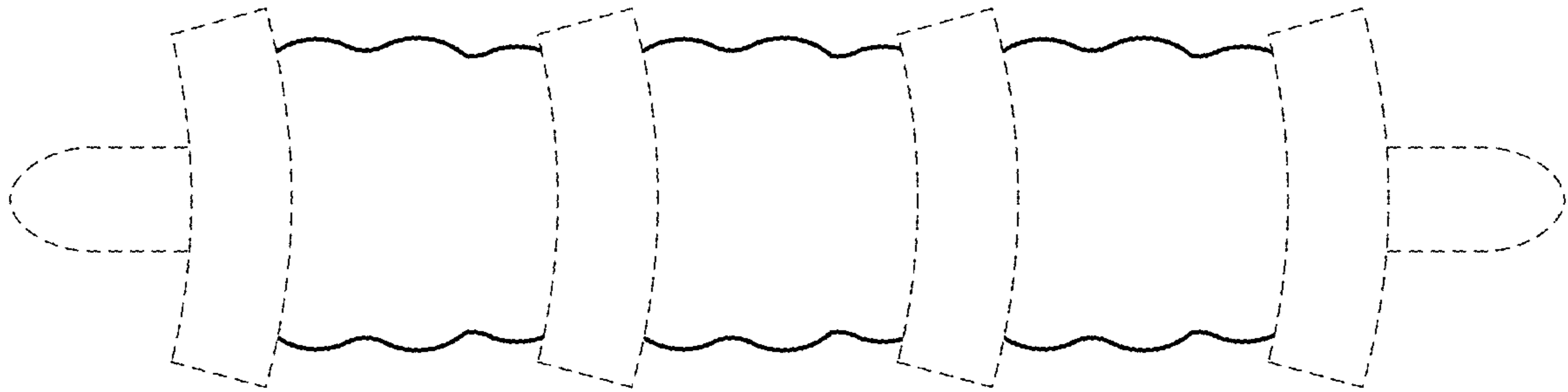
**FIG. 11**



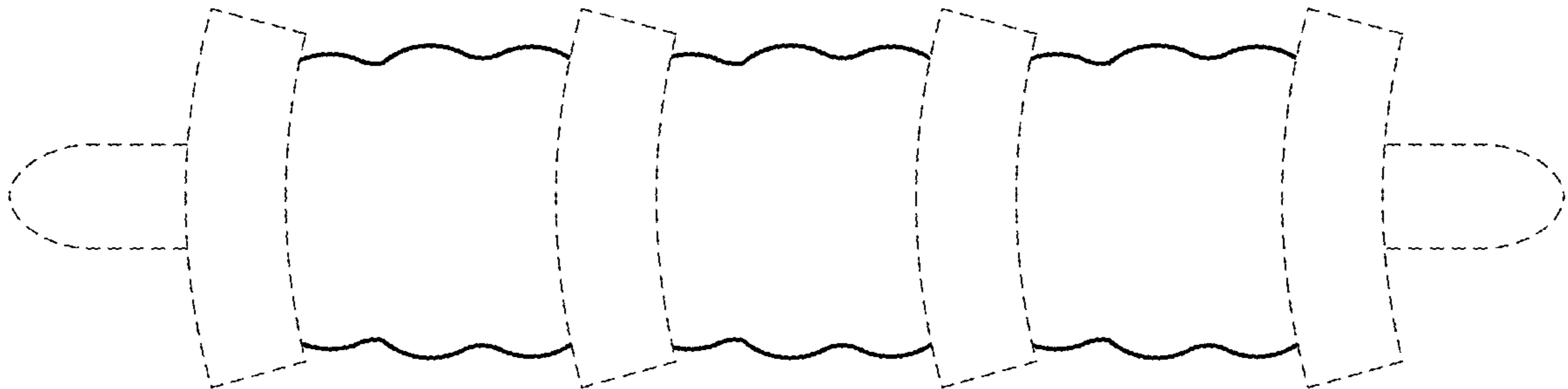
**FIG. 12**



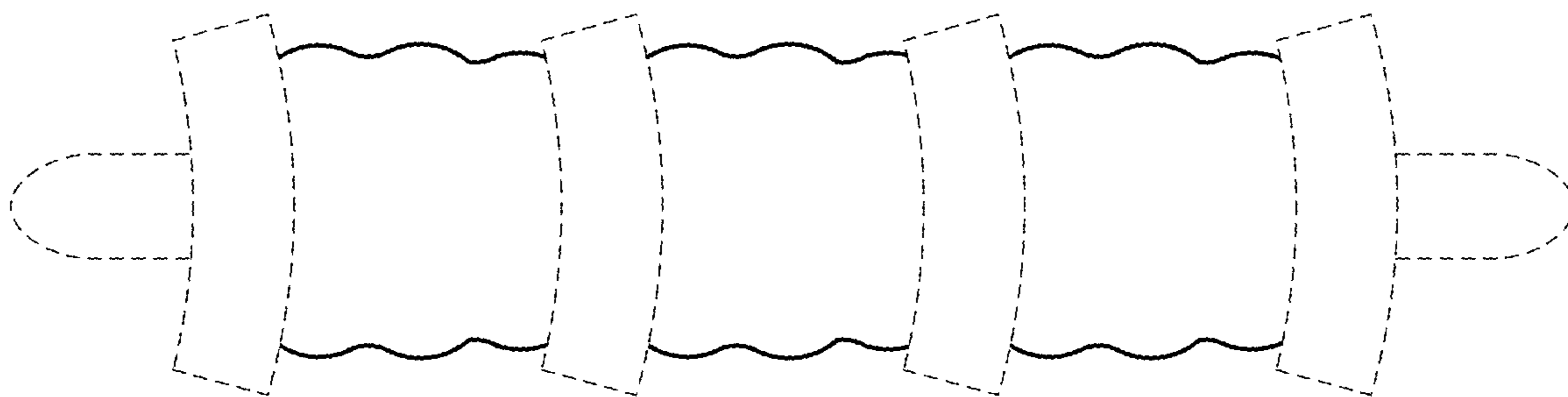
**FIG. 13**



**FIG. 14**



**FIG. 15**



**FIG. 16**

