

US00D968678S

(12) **United States Design Patent** (10) **Patent No.:** **US D968,678 S**
Garrett et al. (45) **Date of Patent:** **** Nov. 1, 2022**

(54) **DECORATIVE SPHERICAL LIGHT**
(71) Applicant: **Jem Accessories, Inc.**, Edison, NJ (US)
(72) Inventors: **Jennifer Garrett**, Rahway, NJ (US);
Elie Chemtob, Eatontown, NJ (US)
(73) Assignee: **Jem Accessories, Inc.**, Edison, NJ (US)
(**) Term: **15 Years**
(21) Appl. No.: **29/811,287**
(22) Filed: **Oct. 13, 2021**

Related U.S. Application Data

(63) Continuation of application No. 29/737,932, filed on Jun. 12, 2020, now Pat. No. Des. 935,683.
(51) **LOC (13) Cl.** **26-05**
(52) **U.S. Cl.**
USPC **D26/104**
(58) **Field of Classification Search**
USPC D26/1, 24, 26, 60, 93, 104, 106, 110,
D26/118, 123, 124, 137; D14/172, 188,
D14/506, 507, 509

(Continued)

(56) **References Cited**

U.S. PATENT DOCUMENTS

D395,715 S * 6/1998 Queen D26/104
D469,207 S * 1/2003 Chang D26/104

(Continued)

Primary Examiner — Wan Laymon

Assistant Examiner — Clint A Samuel

(74) *Attorney, Agent, or Firm* — Goldberg Cohen LLP

(57) **CLAIM**

The ornamental design for a decorative spherical light, as shown and described.

DESCRIPTION

FIG. 1 is an isometric right front view of a decorative spherical light;
FIG. 2 is an isometric top, right rear view thereof;
FIG. 3 is an isometric bottom, left front view thereof;
FIG. 4 is a front view thereof;
FIG. 5 is a rear view thereof;
FIG. 6 is a right side view thereof;
FIG. 7 is a left side view thereof;
FIG. 8 is a top view thereof;
FIG. 9 is a bottom view thereof;
FIG. 10 is a right elevation sectional view of the decorative spherical light taken along the line 10-10 of FIG. 8;
FIG. 11 is a rear elevation sectional view of the decorative spherical light taken along the line 11-11 of FIG. 8;
FIG. 12 is an isometric rear elevation sectional view of the decorative spherical light taken along the line 11-11 of FIG. 8;
FIG. 13 is an isometric right front view of an alternate embodiment decorative spherical light;
FIG. 14 is an isometric top, right rear view thereof;
FIG. 15 is an isometric bottom, left front view thereof;
FIG. 16 is a front view thereof;
FIG. 17 is a rear view thereof;
FIG. 18 is a right side view thereof;
FIG. 19 is a left side view thereof;
FIG. 20 is a top view thereof;
FIG. 21 is a bottom view thereof;
FIG. 22 is a right elevation sectional view of the decorative spherical light taken along the line 22-22 of FIG. 20;
FIG. 23 is a rear elevation sectional view of the decorative spherical light taken along the line 23-23 of FIG. 20; and,
FIG. 24 is an isometric rear elevation sectional view of the decorative spherical light taken along the line 23-23 of FIG. 20.

The evenly spaced broken lines in the drawings depict portions of the embodiments of the decorative spherical light which form no part of the claim.

1 Claim, 24 Drawing Sheets

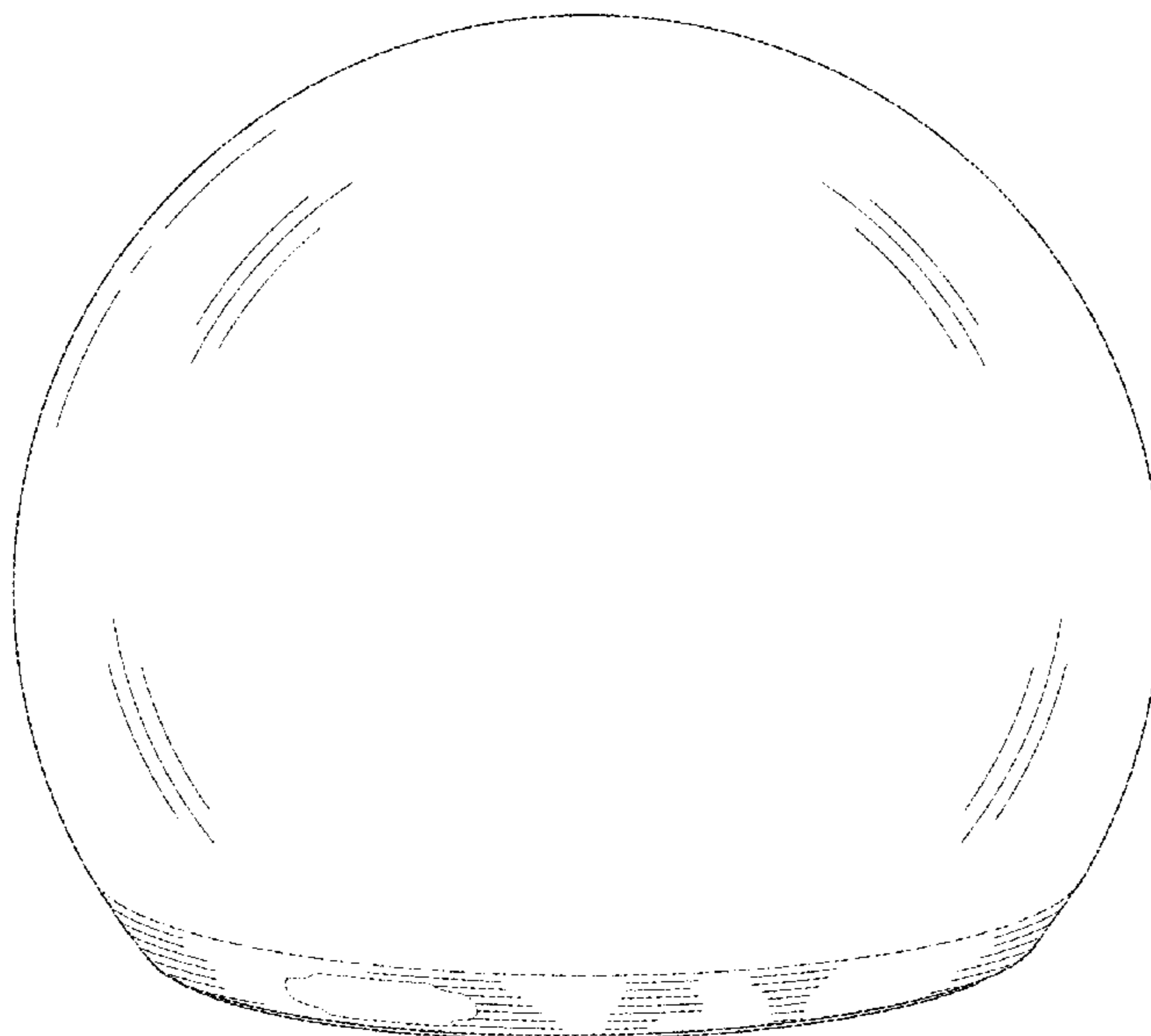

(58) **Field of Classification Search**

CPC F21S 6/00; F21S 6/002; F21S 6/003; F21S 6/006; F21S 8/00; F21S 8/02; F21S 8/03; F21S 8/04; F21S 9/02; F21S 9/03; F21S 9/022; F21V 21/08; F21V 21/092; F21V 21/095; F21V 37/00; F21V 37/0095; F21W 2131/30; F21W 2131/302

See application file for complete search history.

(56) **References Cited**

U.S. PATENT DOCUMENTS

D605,337	S	*	12/2009	Zhang	D26/104
D696,298	S	*	12/2013	Britt, Jr.	D14/496
D731,107	S	*	6/2015	Wu	D26/104
D756,541	S	*	5/2016	Lagier	D26/1
D848,051	S	*	5/2019	Huang	D26/104
D854,226	S	*	7/2019	Lin	D26/104
D858,860	S	*	9/2019	Lin	D26/106
D861,964	S	*	10/2019	Lin	D26/110
D875,994	S	*	2/2020	Yu	D26/104
D884,955	S	*	5/2020	Yi	D26/104
D887,069	S	*	6/2020	Dou	D26/104
D887,073	S	*	6/2020	Lin	D26/106
D890,406	S	*	7/2020	Chen	D26/104
D891,682	S	*	7/2020	Wei	D29/104
D896,808	S	*	9/2020	Koh	D14/496
D901,065	S	*	11/2020	Wang	D26/104
D905,318	S	*	12/2020	Cui	D26/106
D907,280	S	*	1/2021	Zeng	D26/104
D907,281	S	*	1/2021	Wu	D26/104
D917,416	S	*	4/2021	DeMaio	D10/22
D918,437	S	*	5/2021	Lum	D26/24
D925,810	S	*	7/2021	Yi	D26/110
D930,212	S	*	9/2021	Liu	D26/63
D935,683	S	*	11/2021	Garrett	D26/104

* cited by examiner

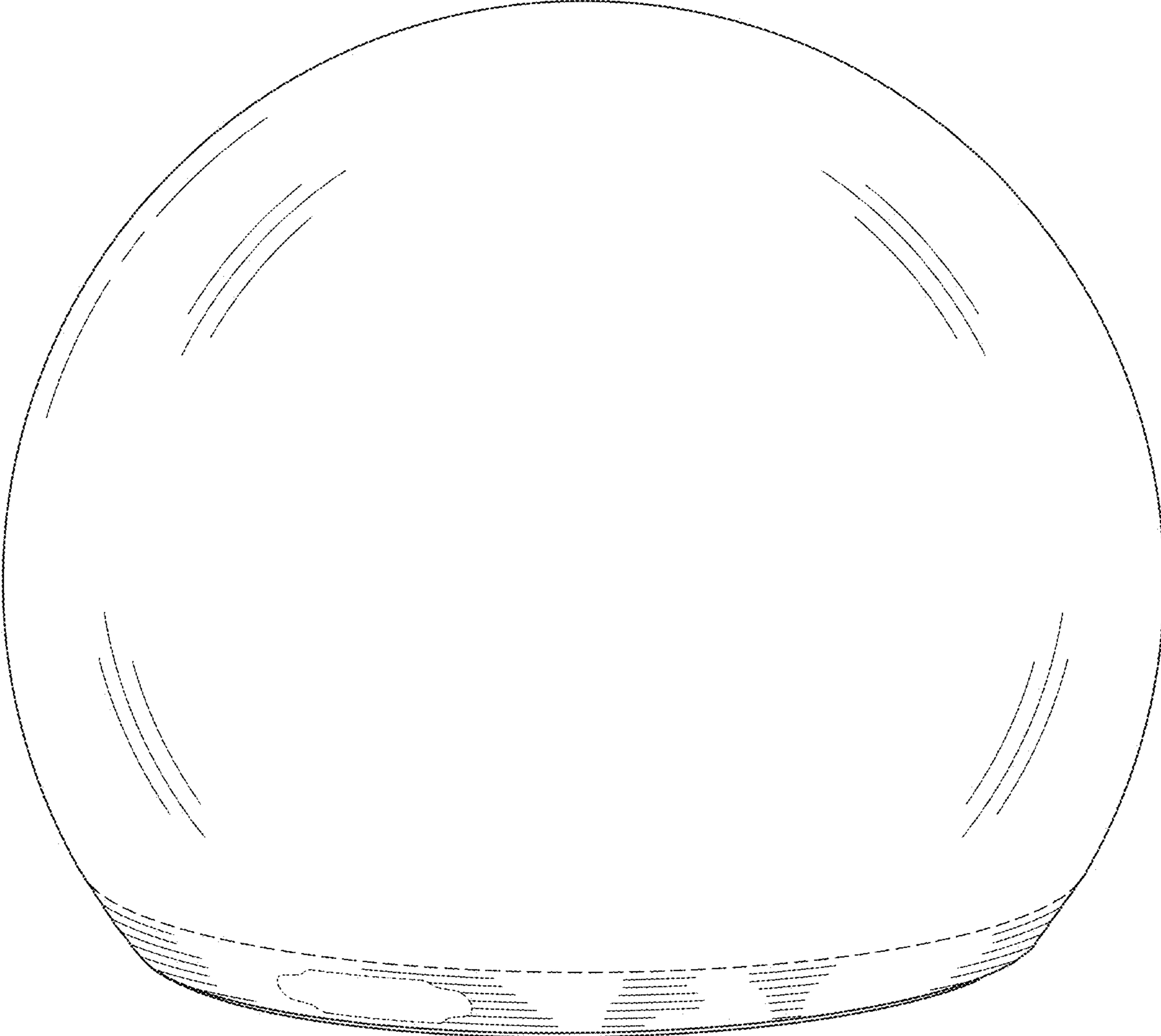

FIG. 1

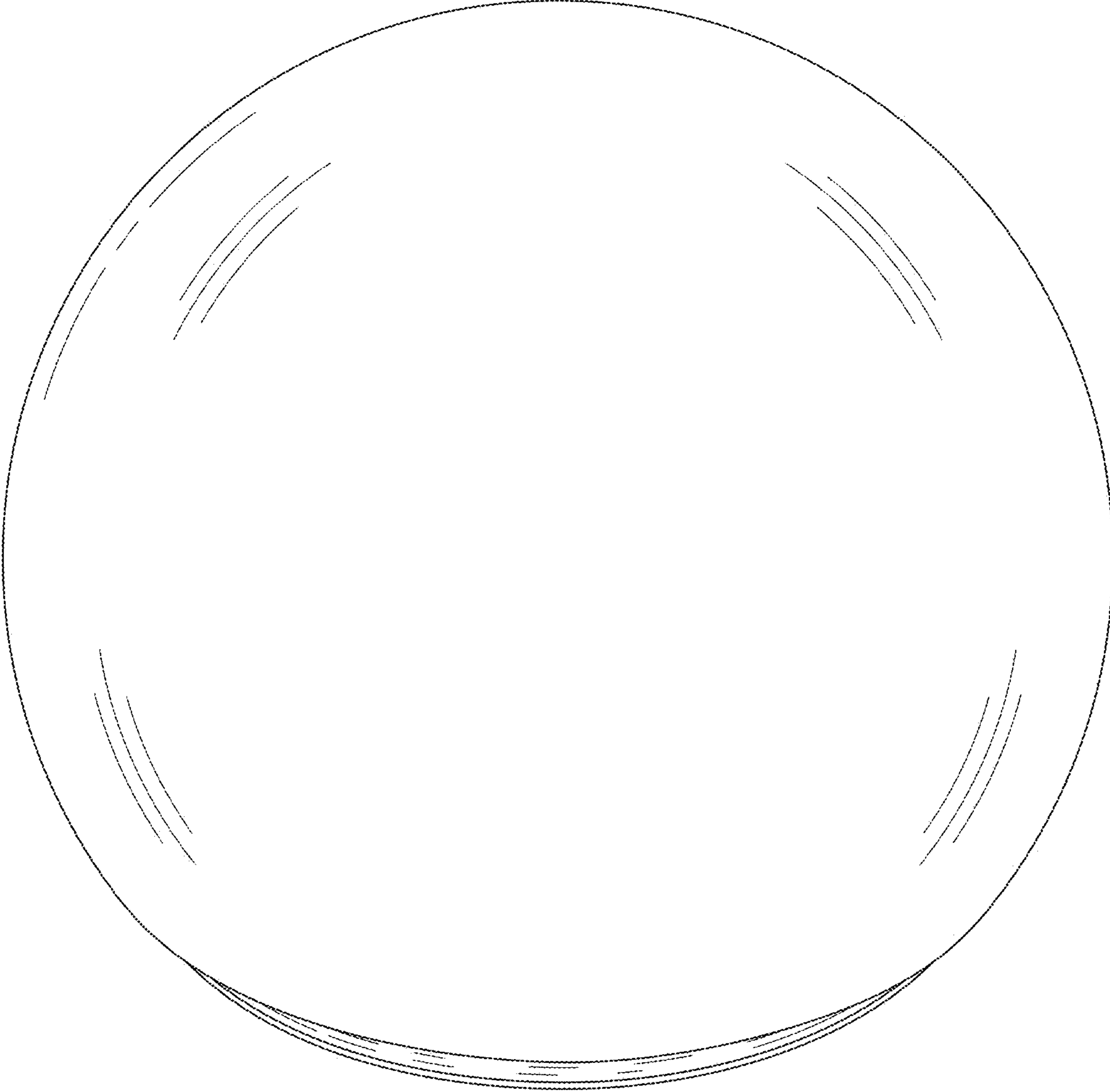

FIG. 2

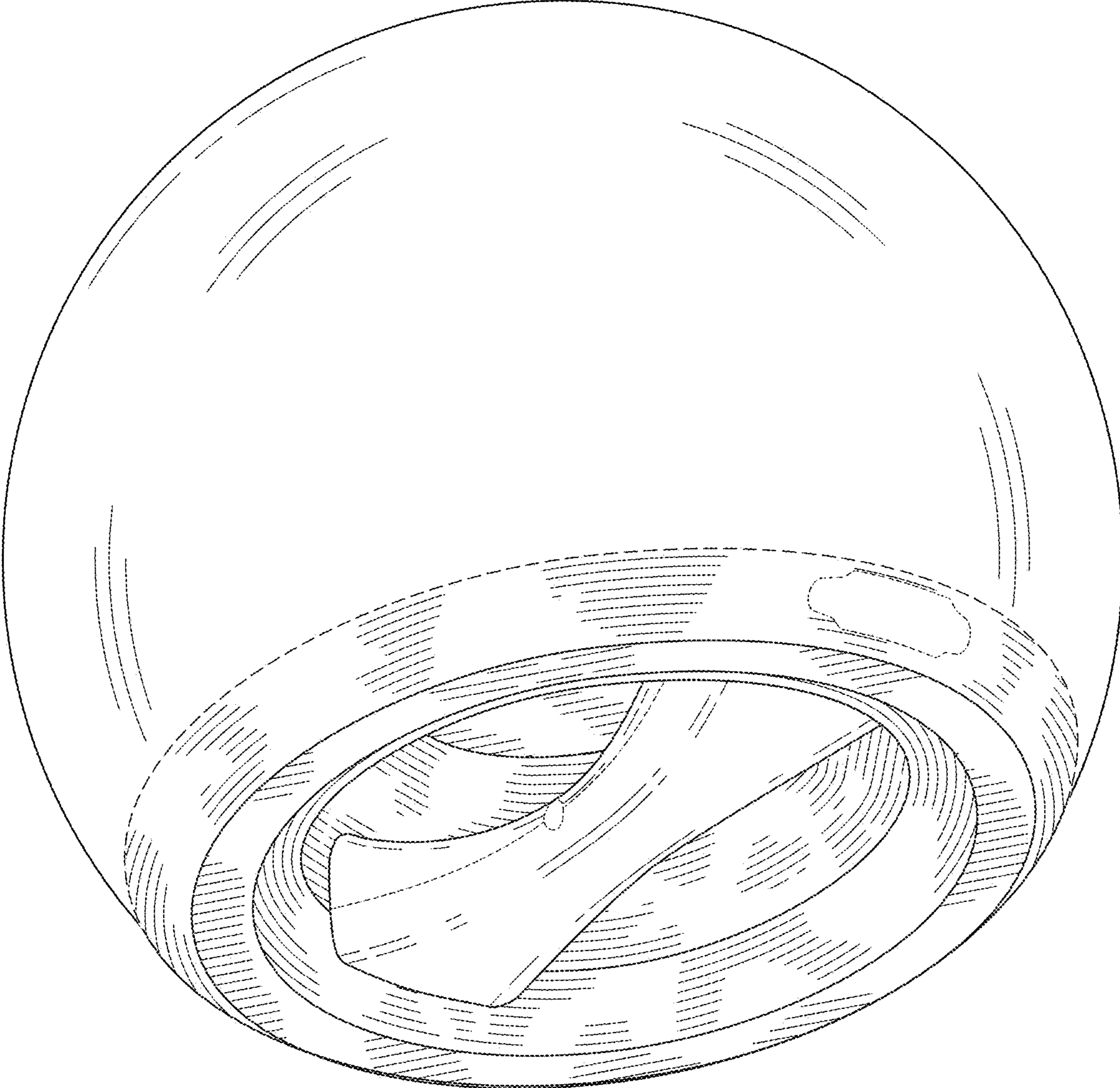

FIG. 3

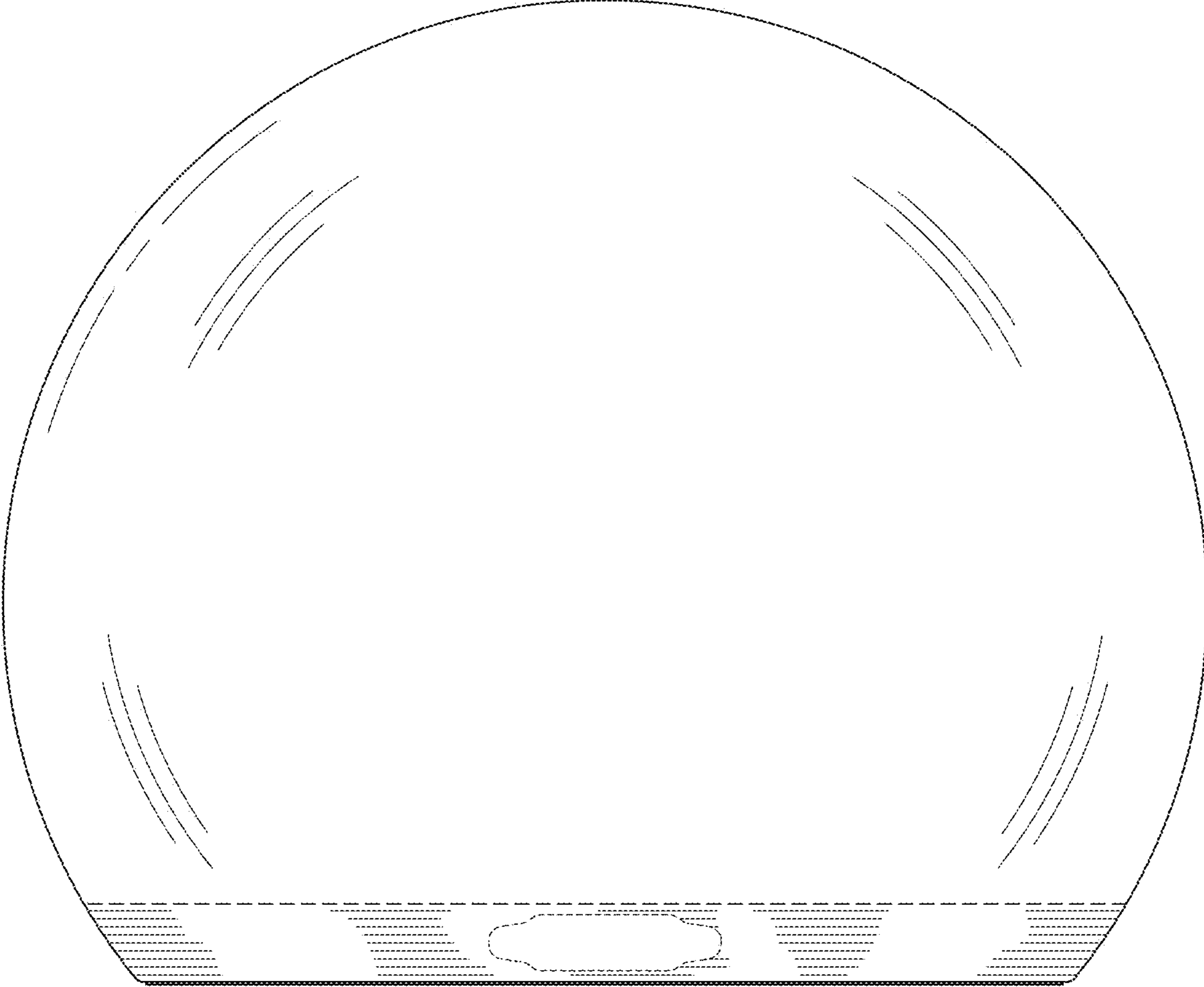

FIG. 4

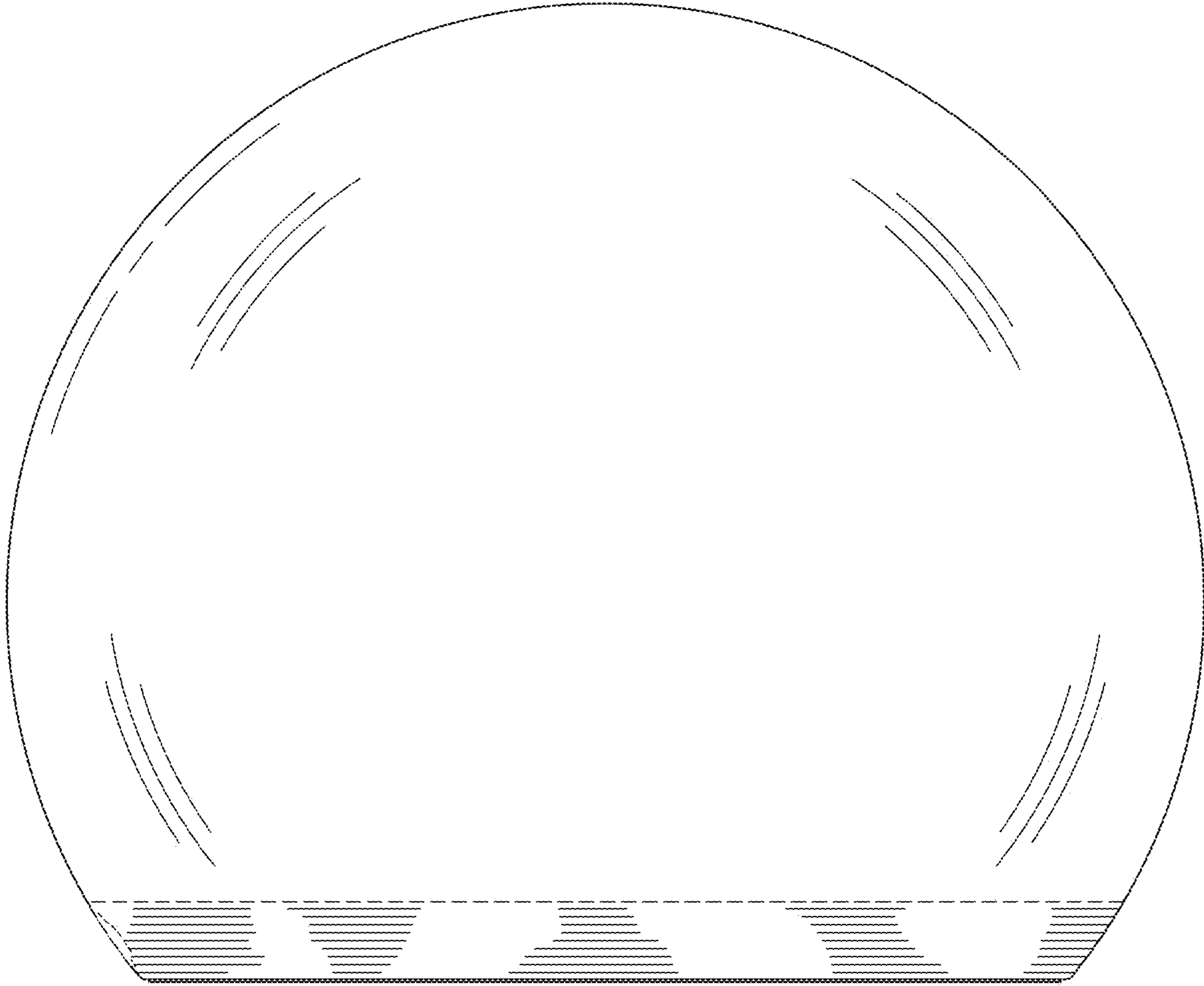

FIG. 5

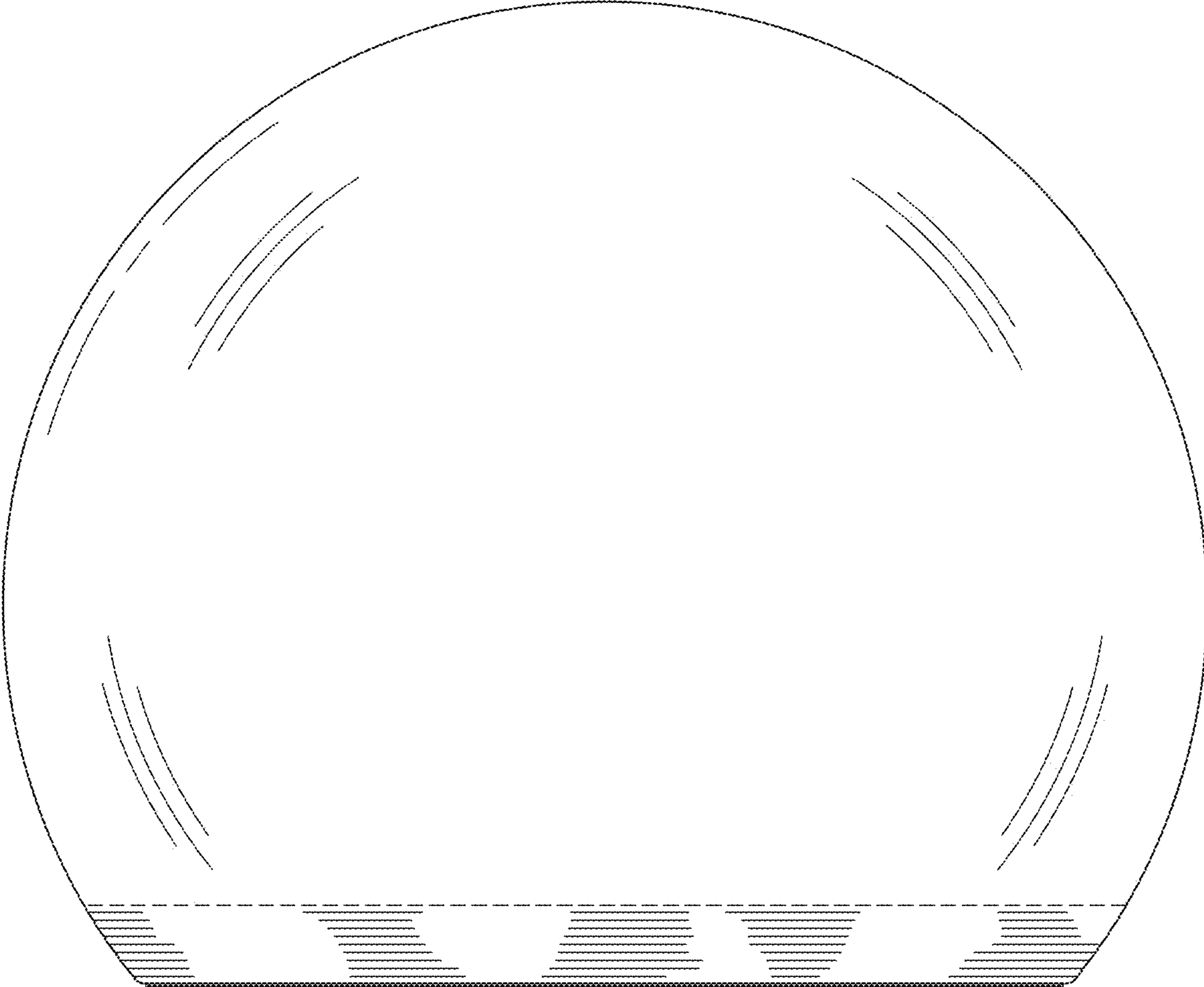

FIG. 6

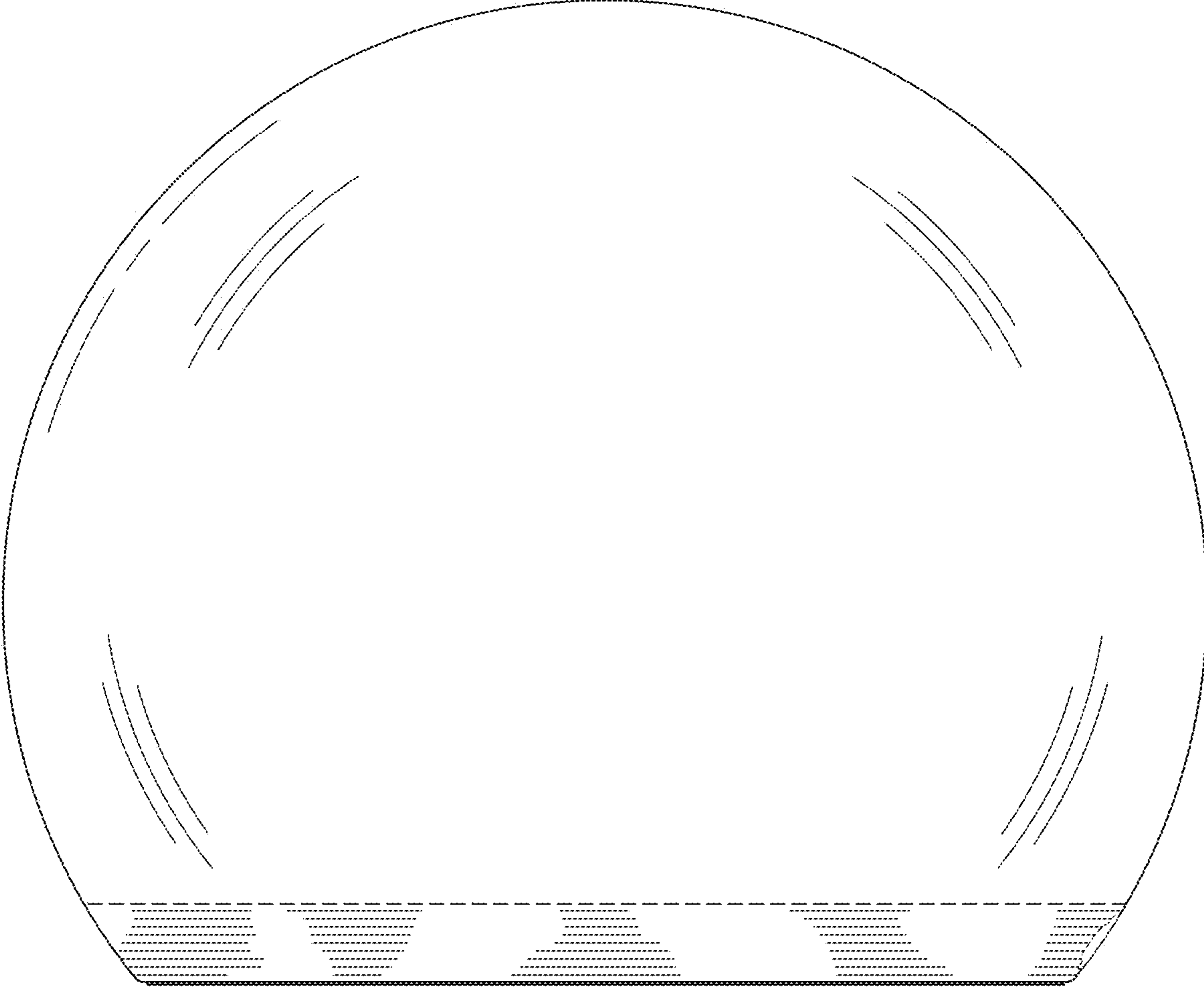

FIG. 7

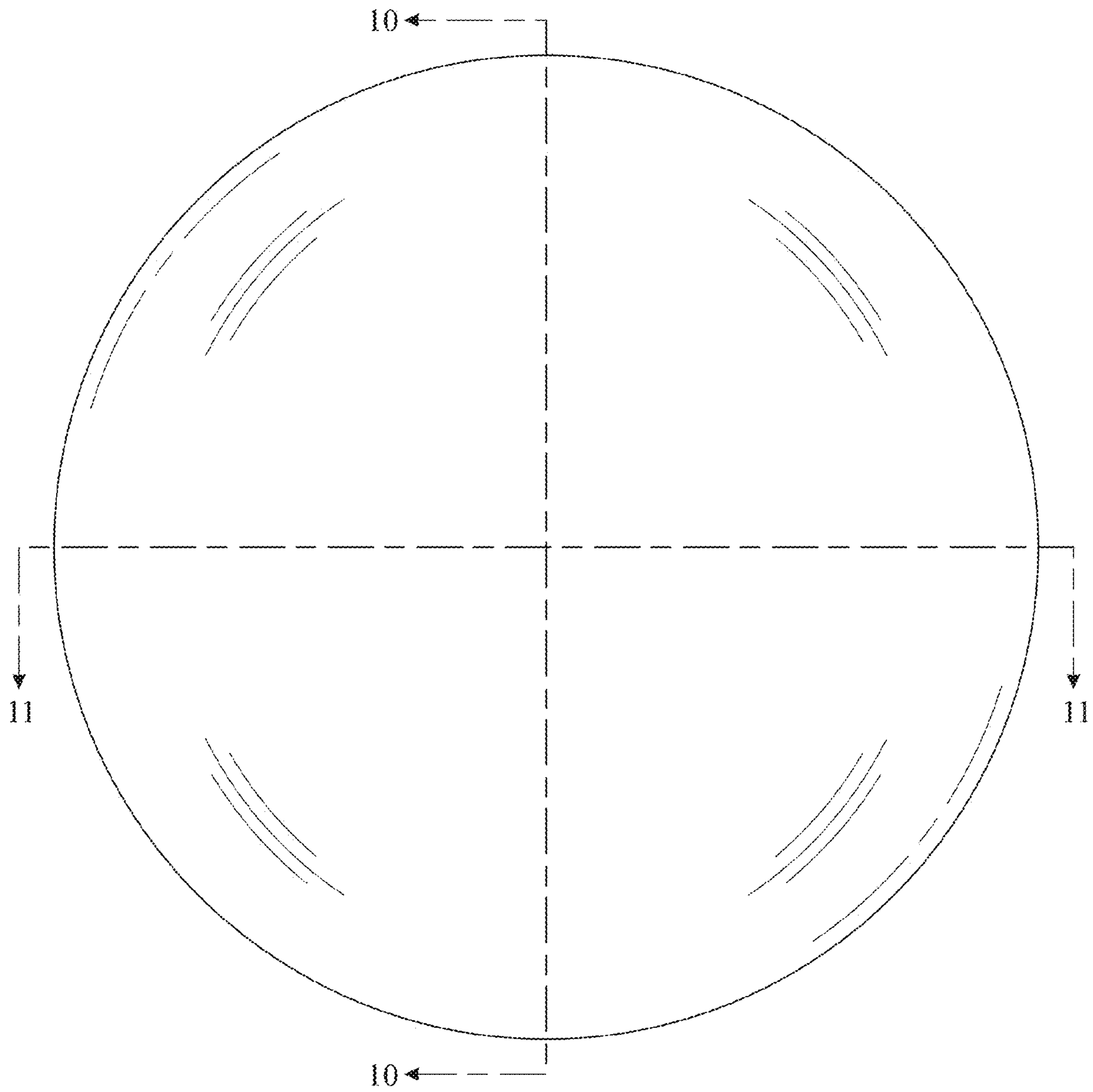

FIG. 8

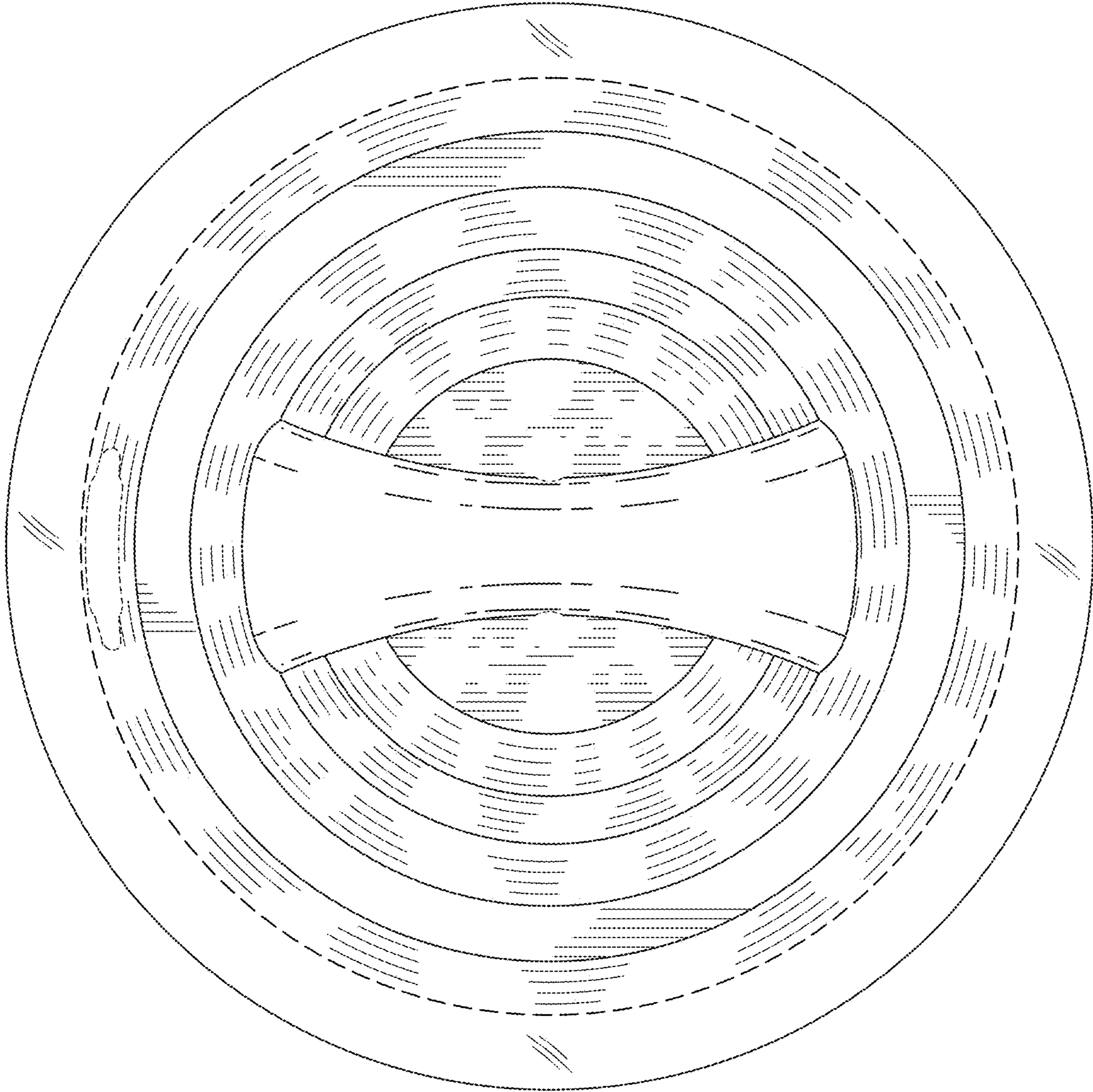

FIG. 9

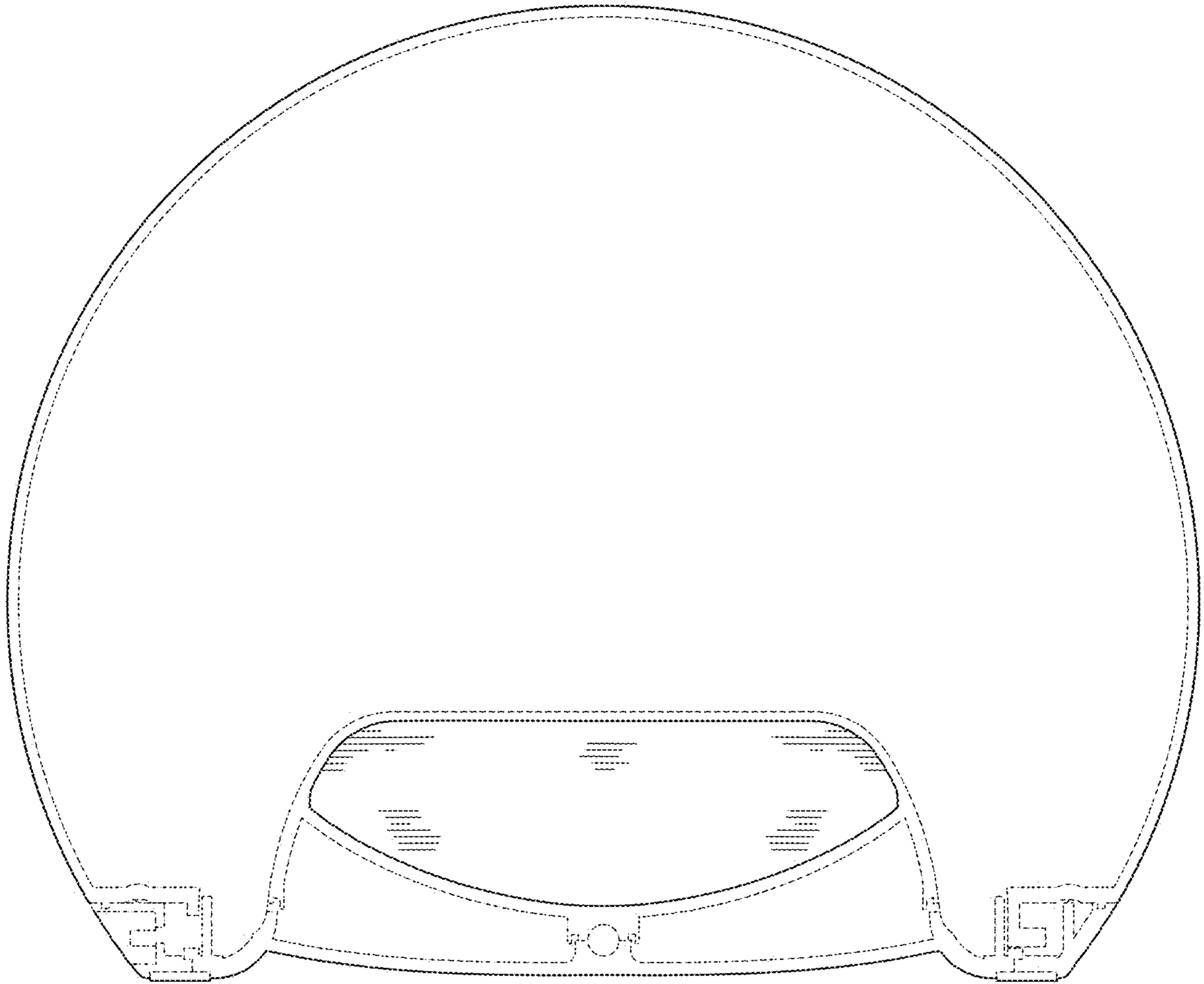

FIG. 10

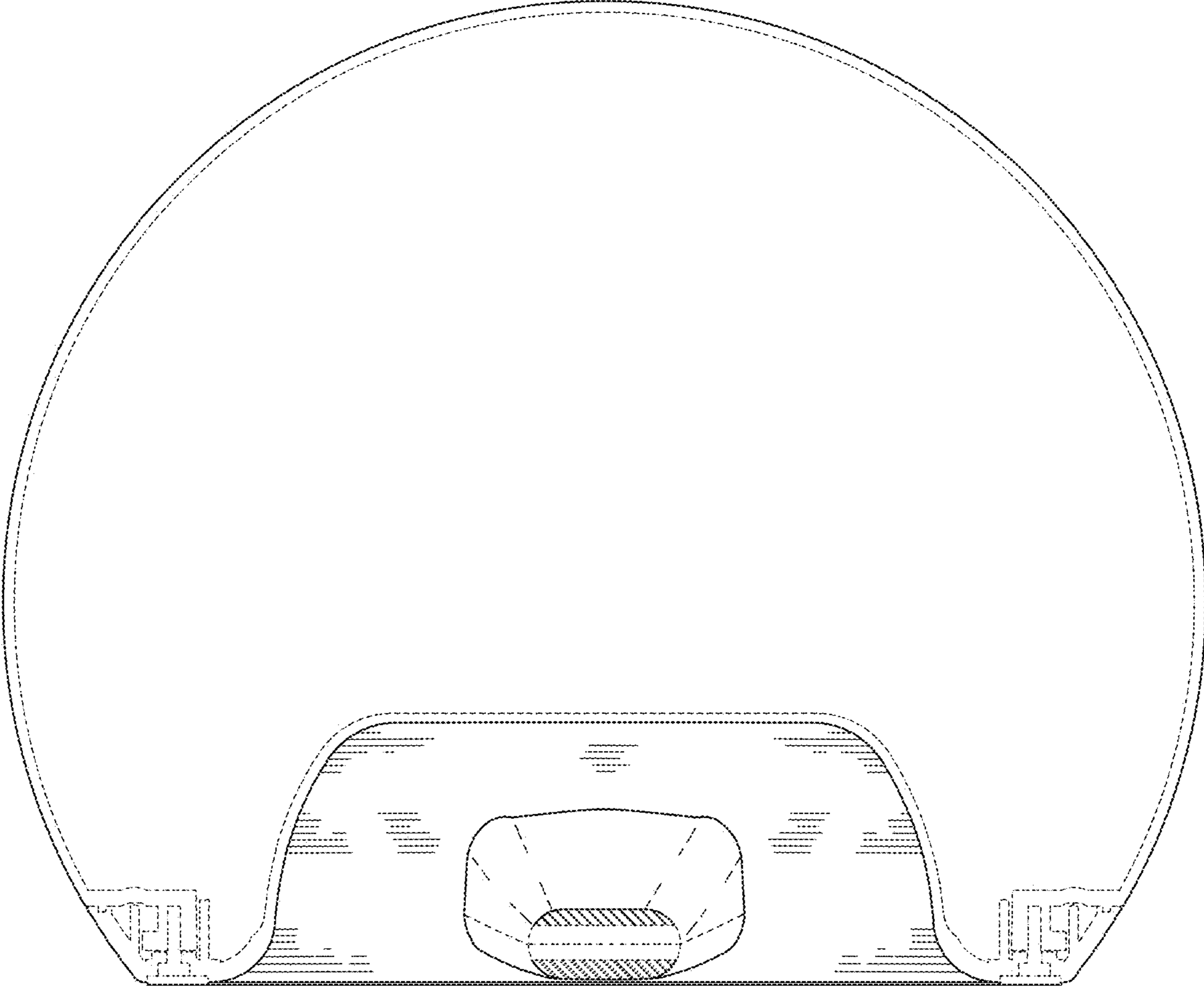

FIG. 11

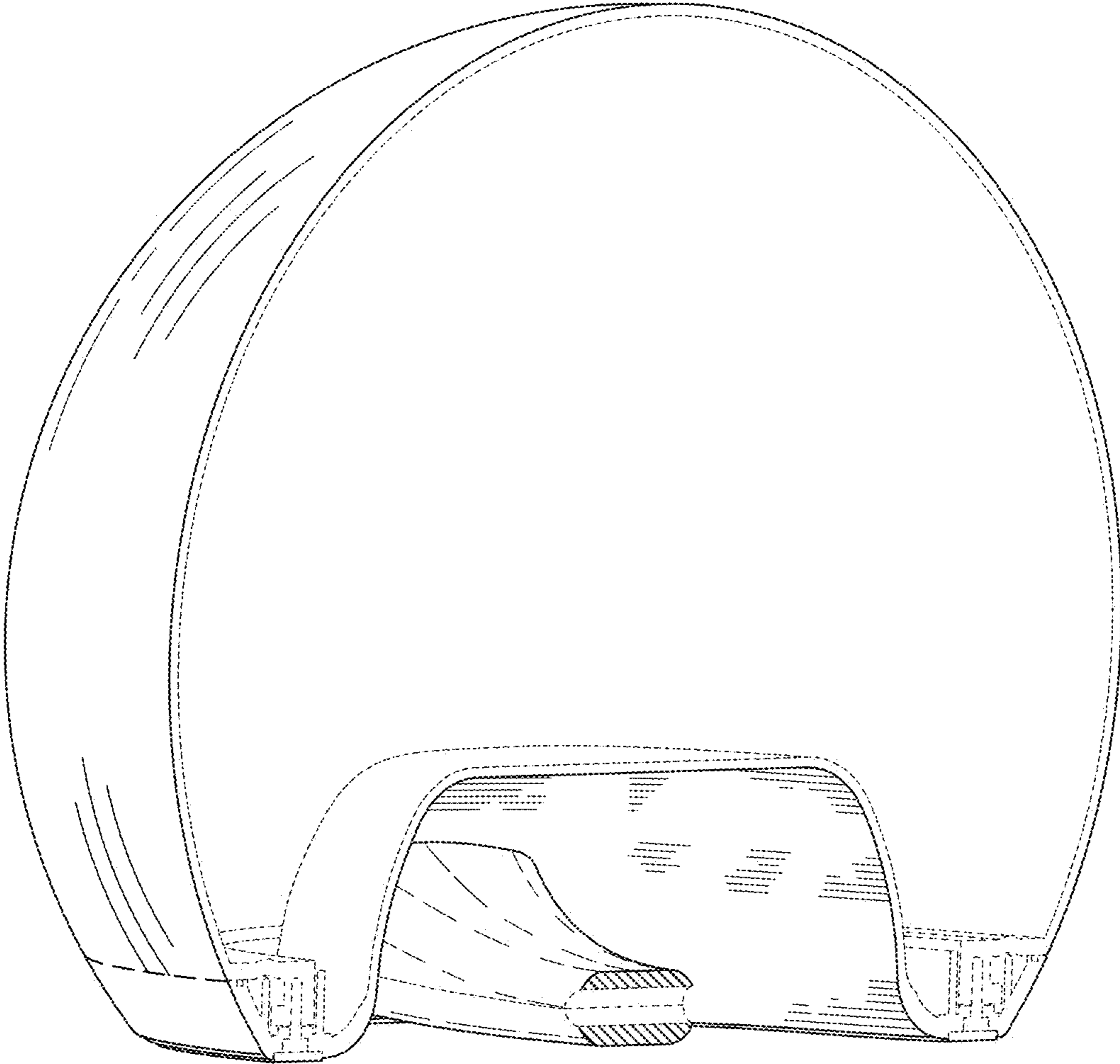

FIG. 12

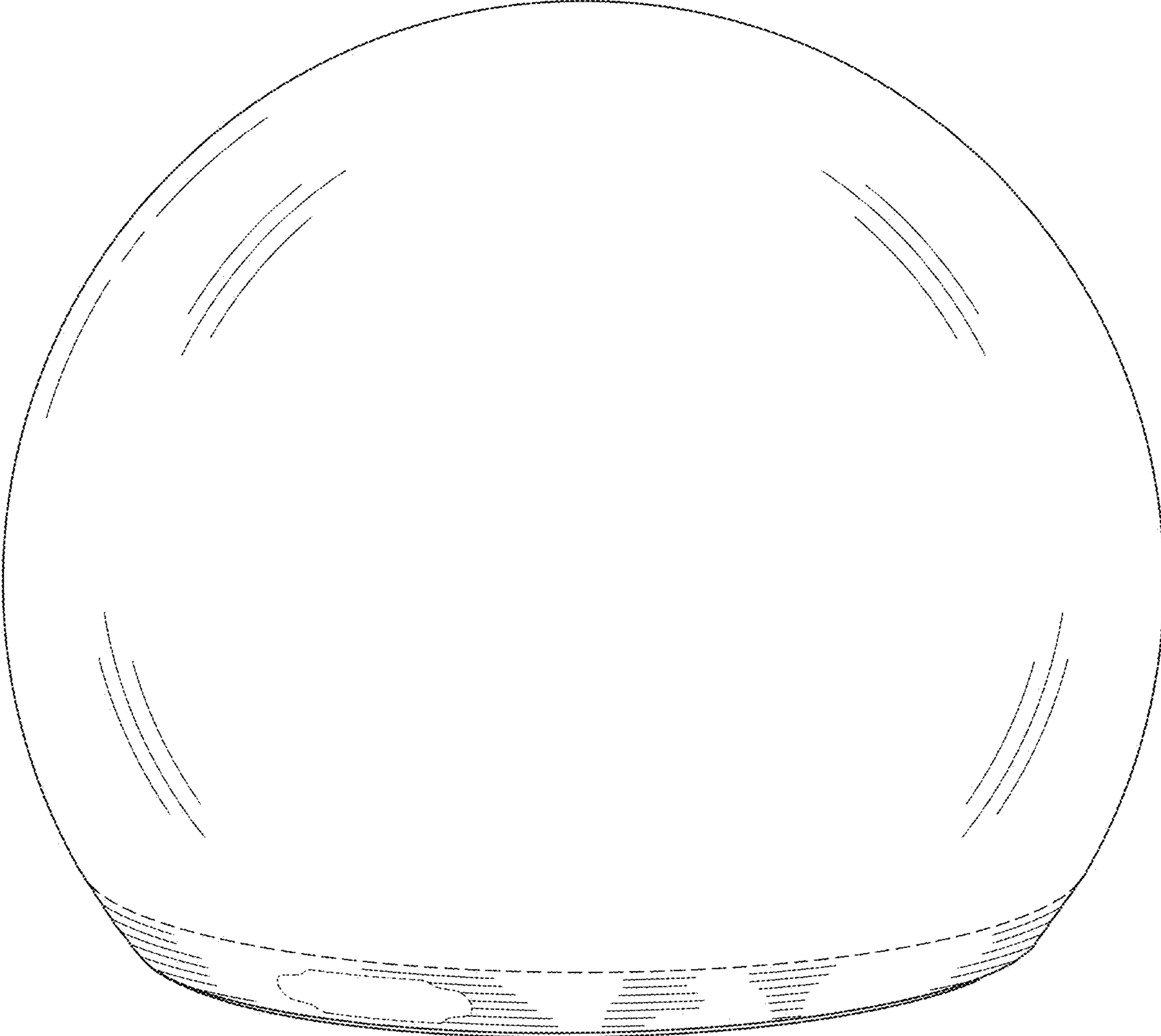

FIG. 13

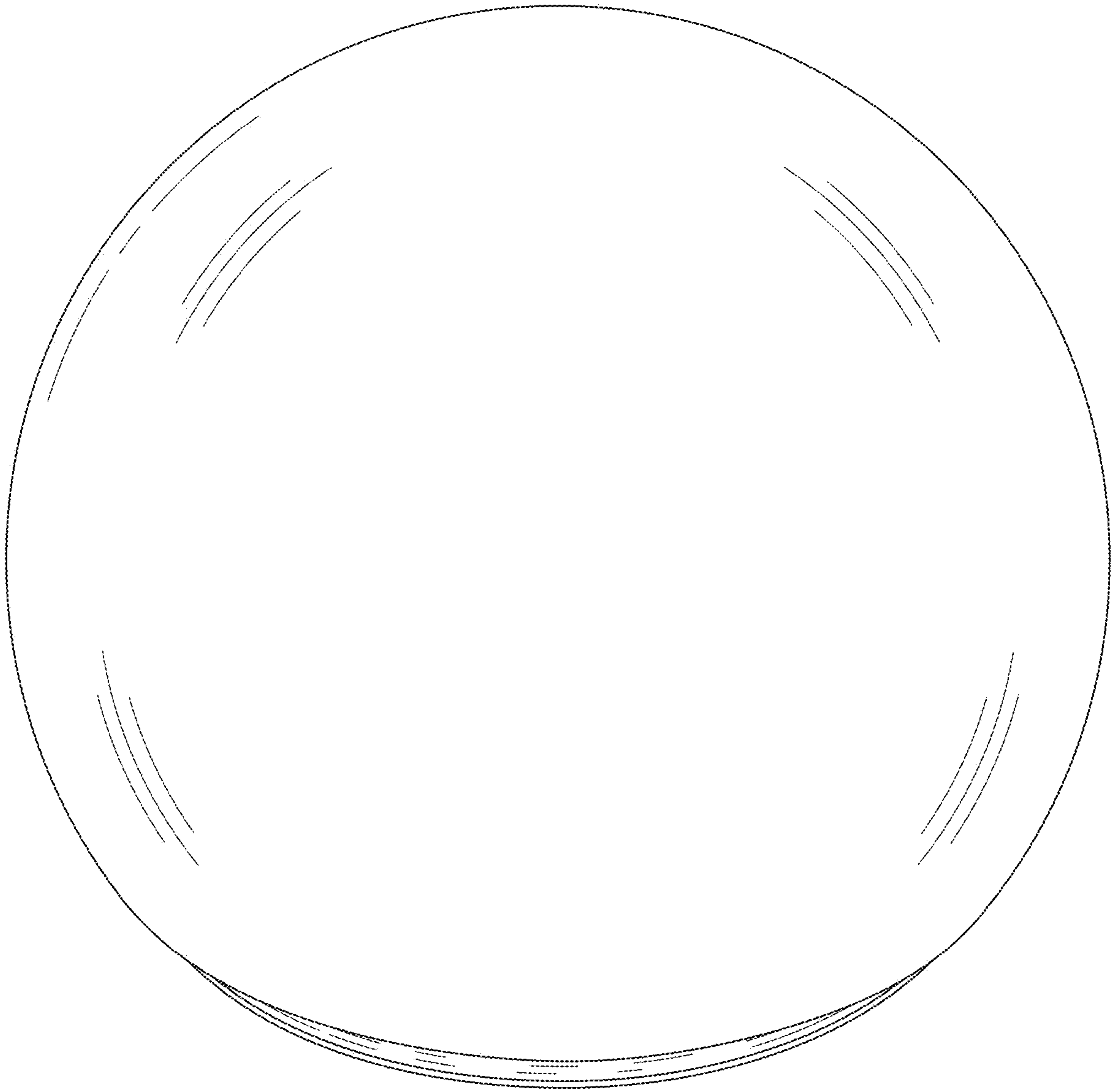

FIG. 14

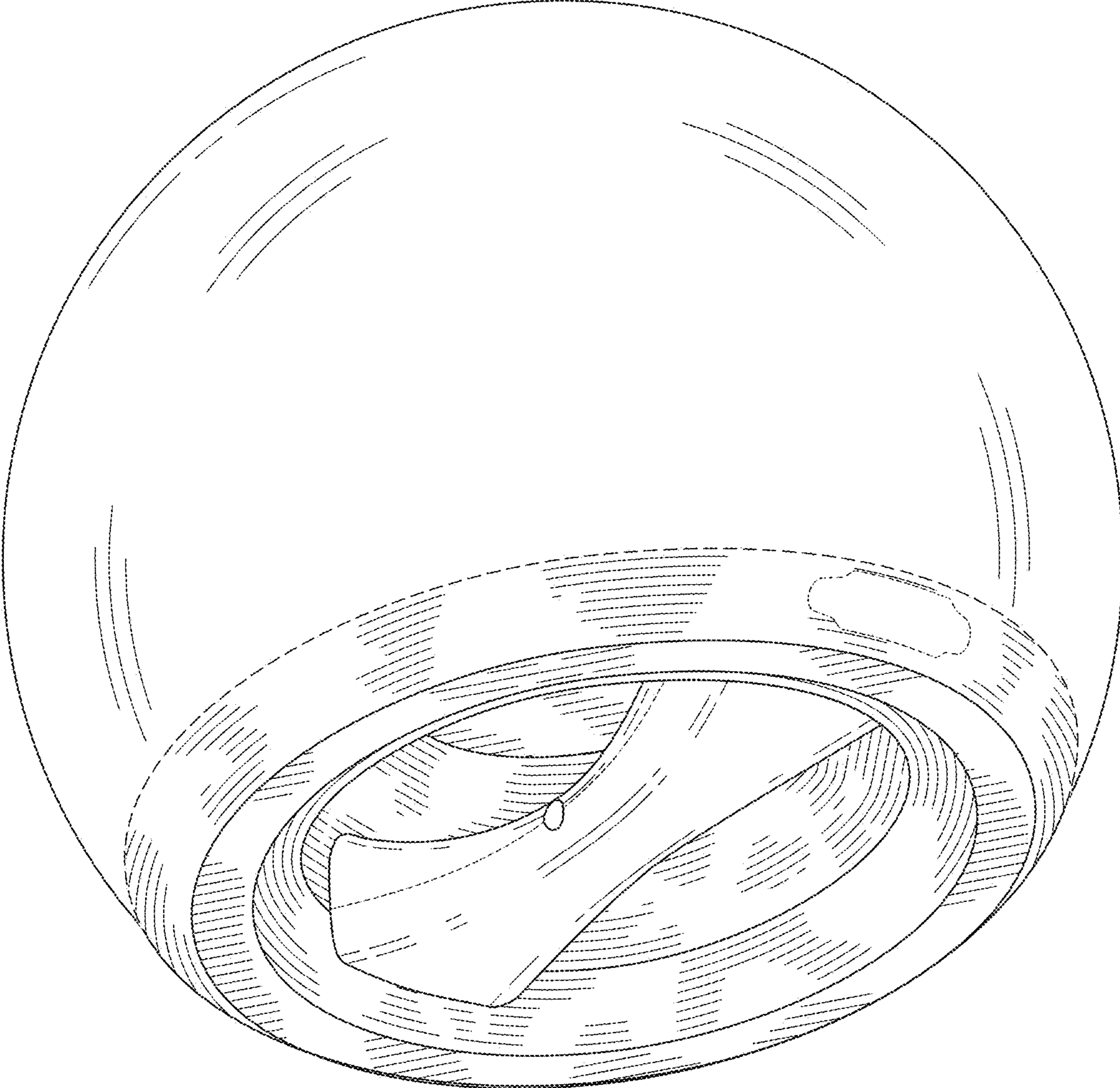

FIG. 15

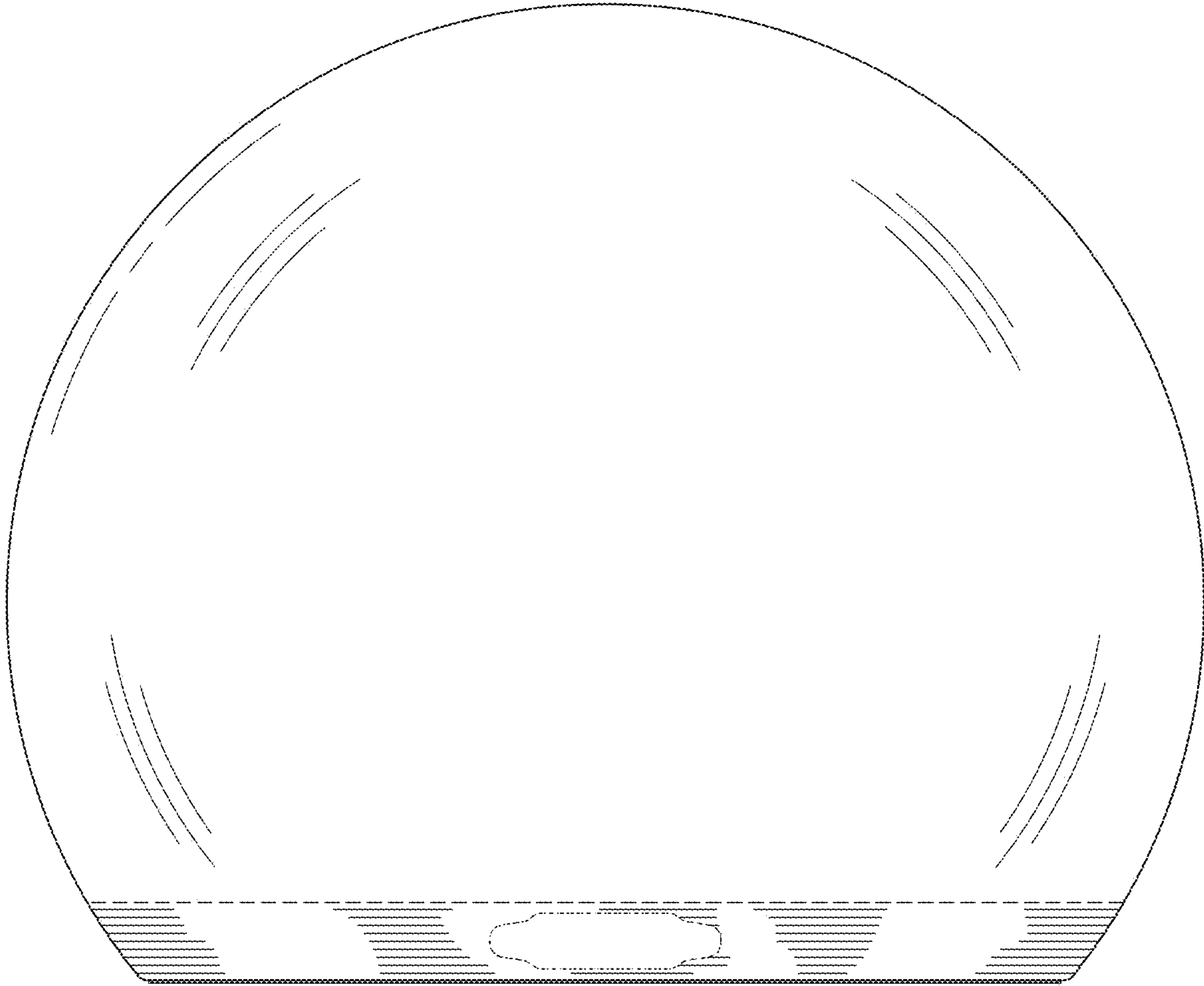

FIG. 16

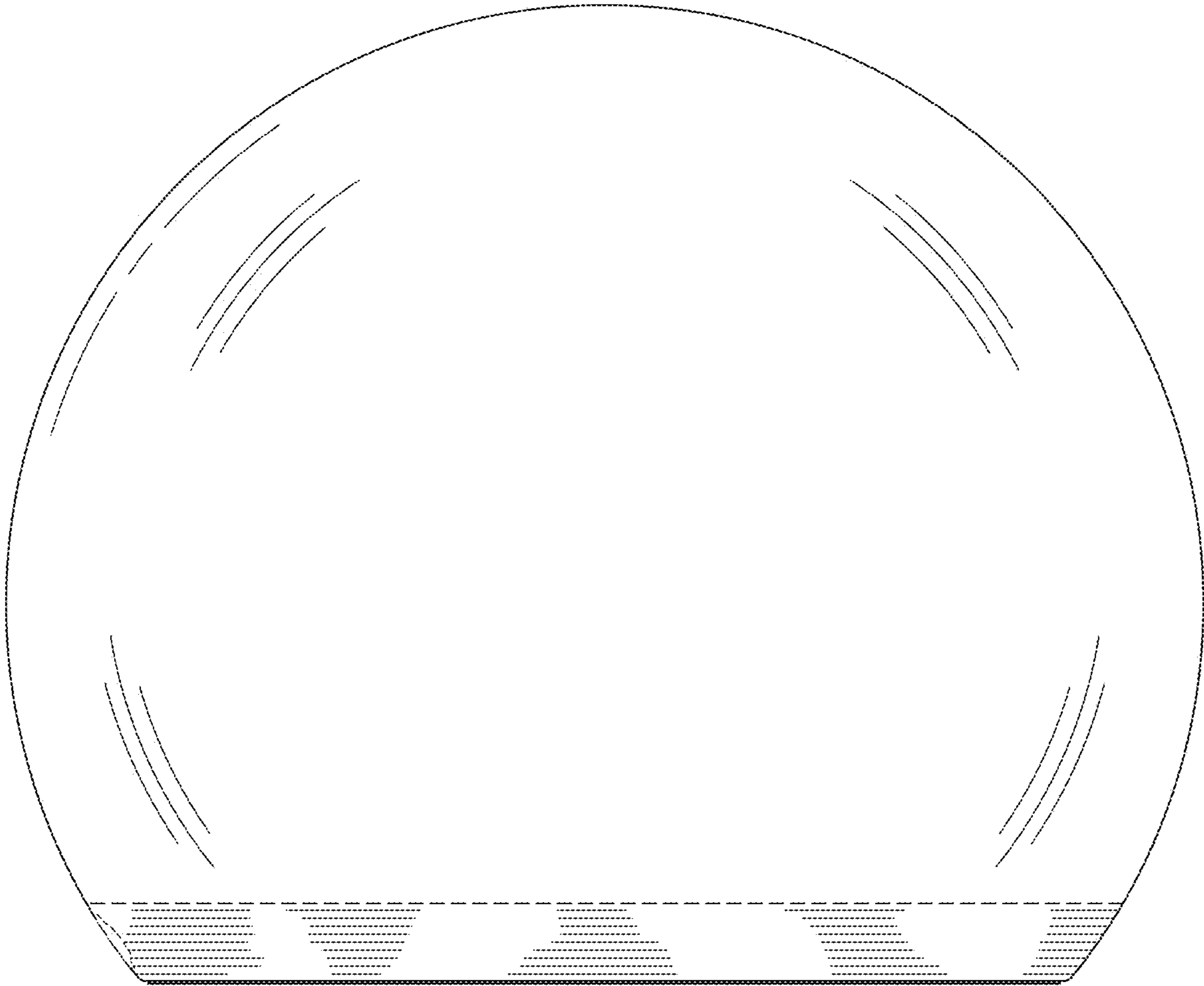

FIG. 17

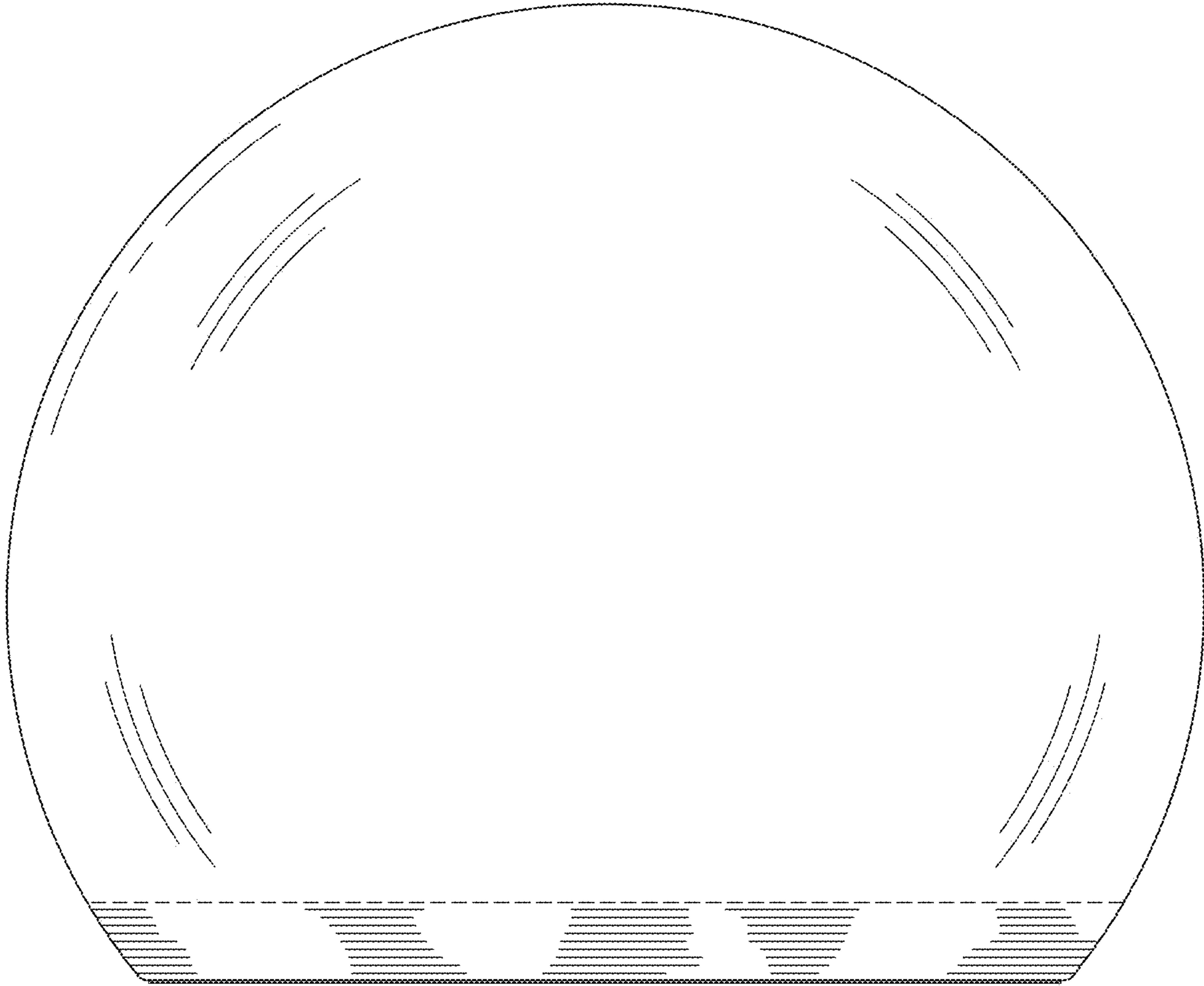

FIG. 18

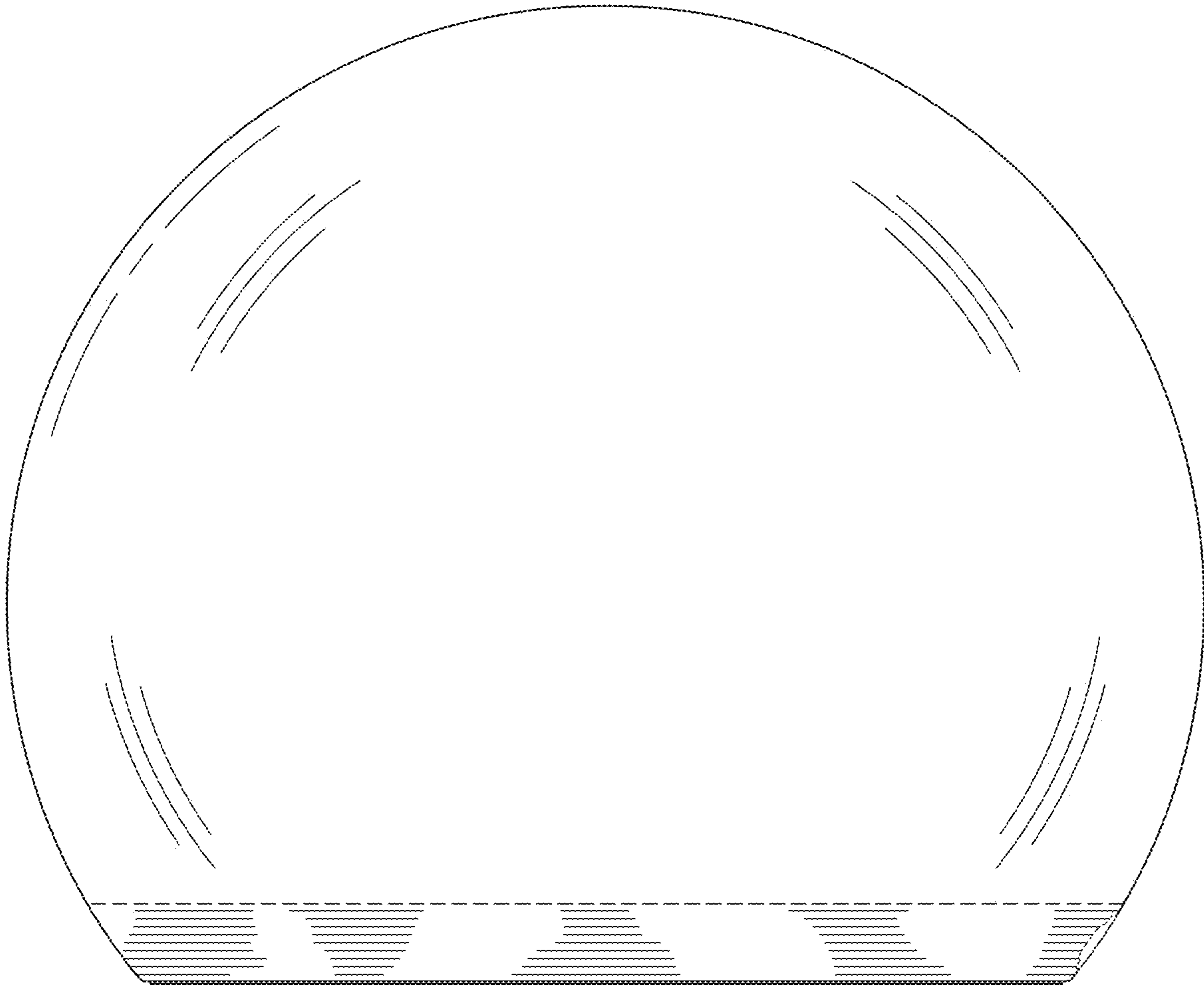

FIG. 19

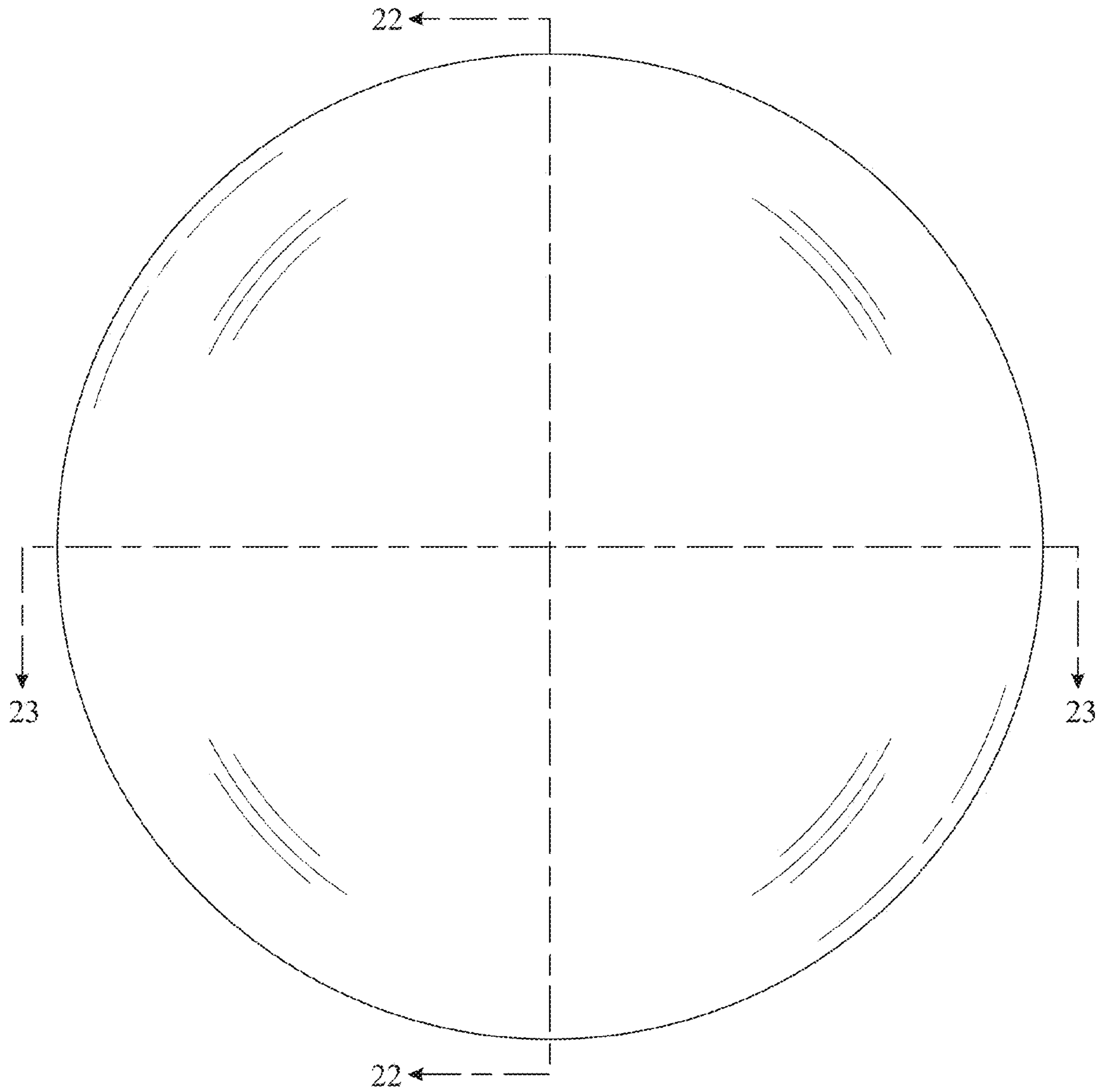

FIG. 20

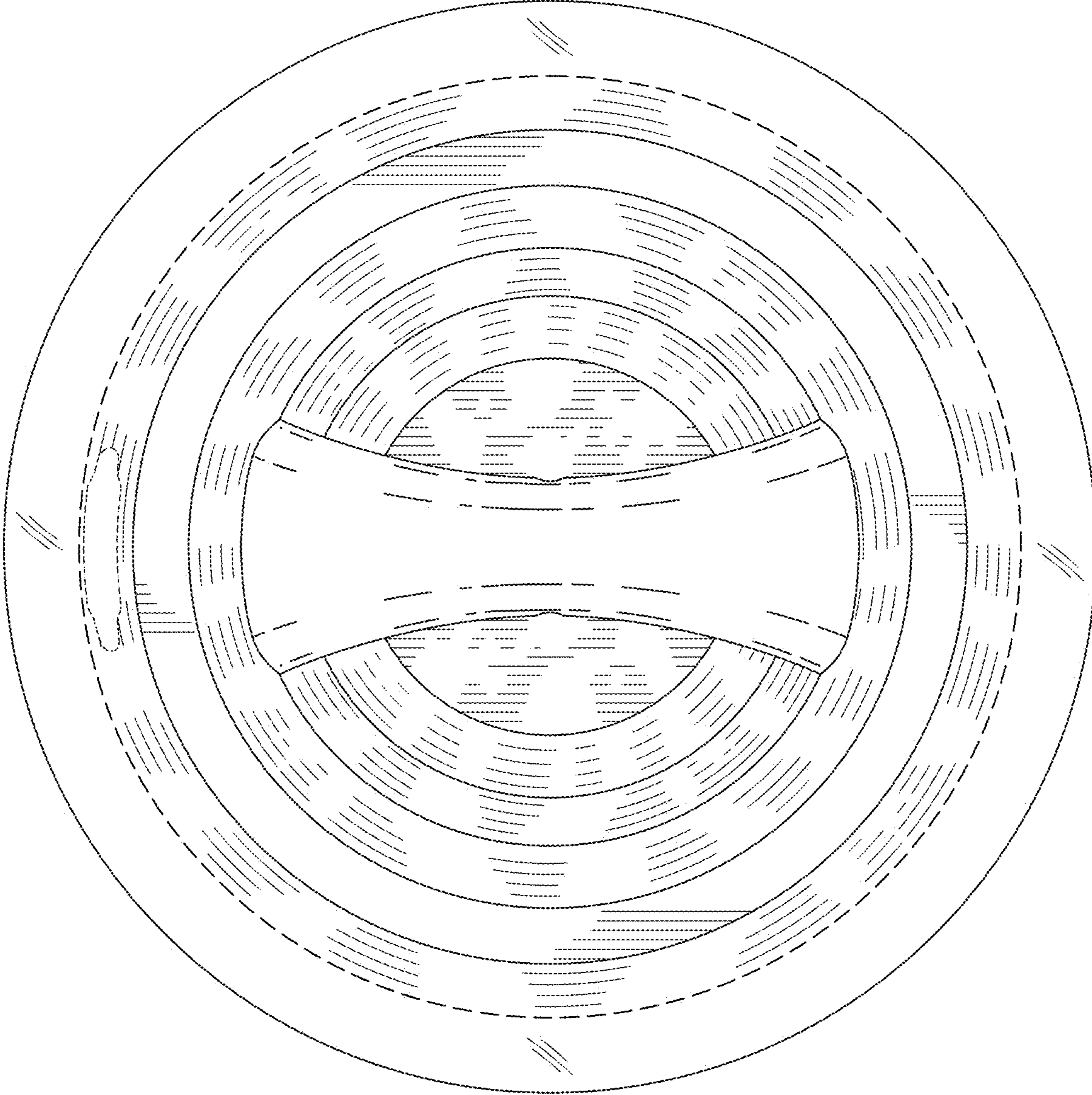

FIG. 21

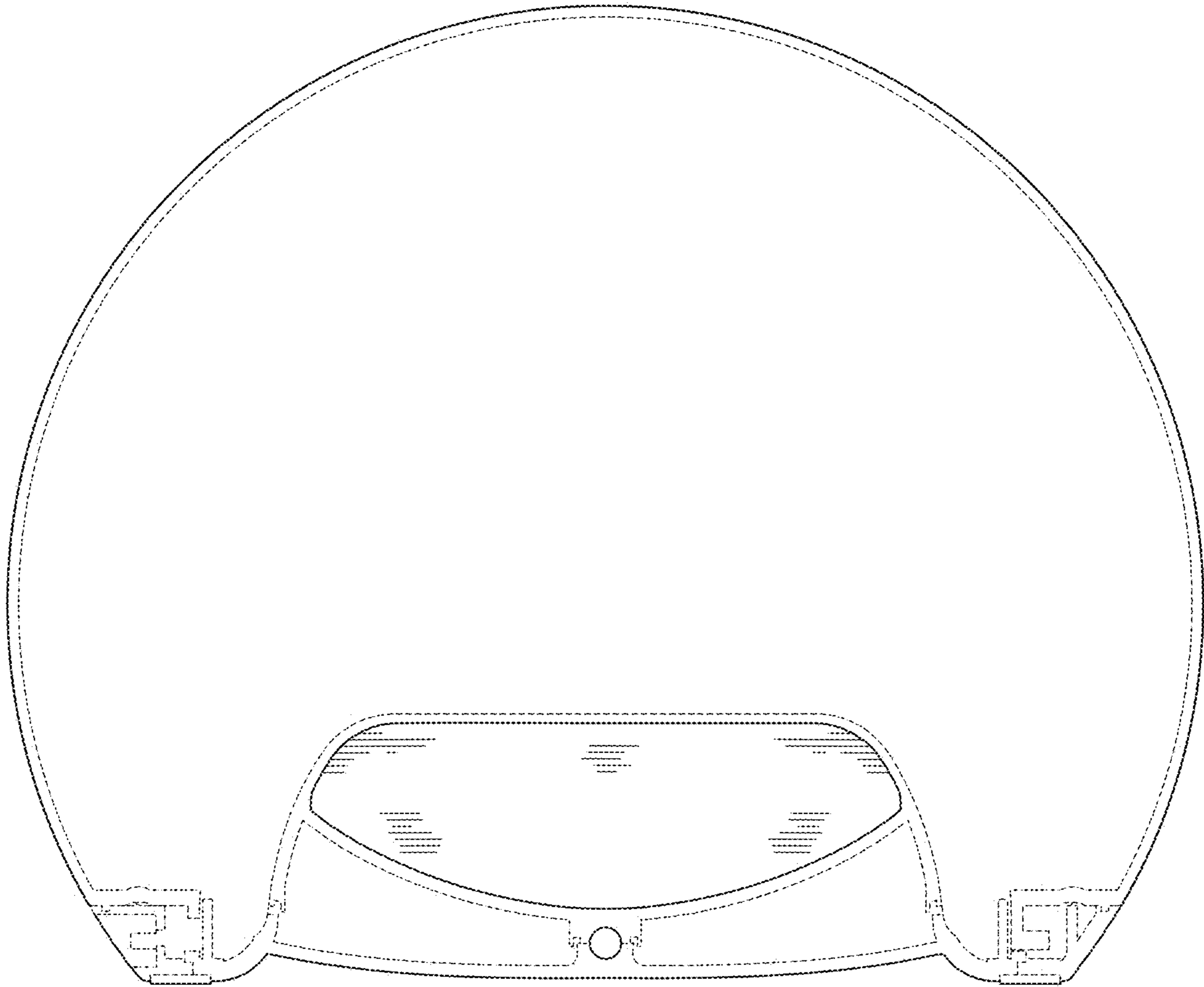

FIG. 22

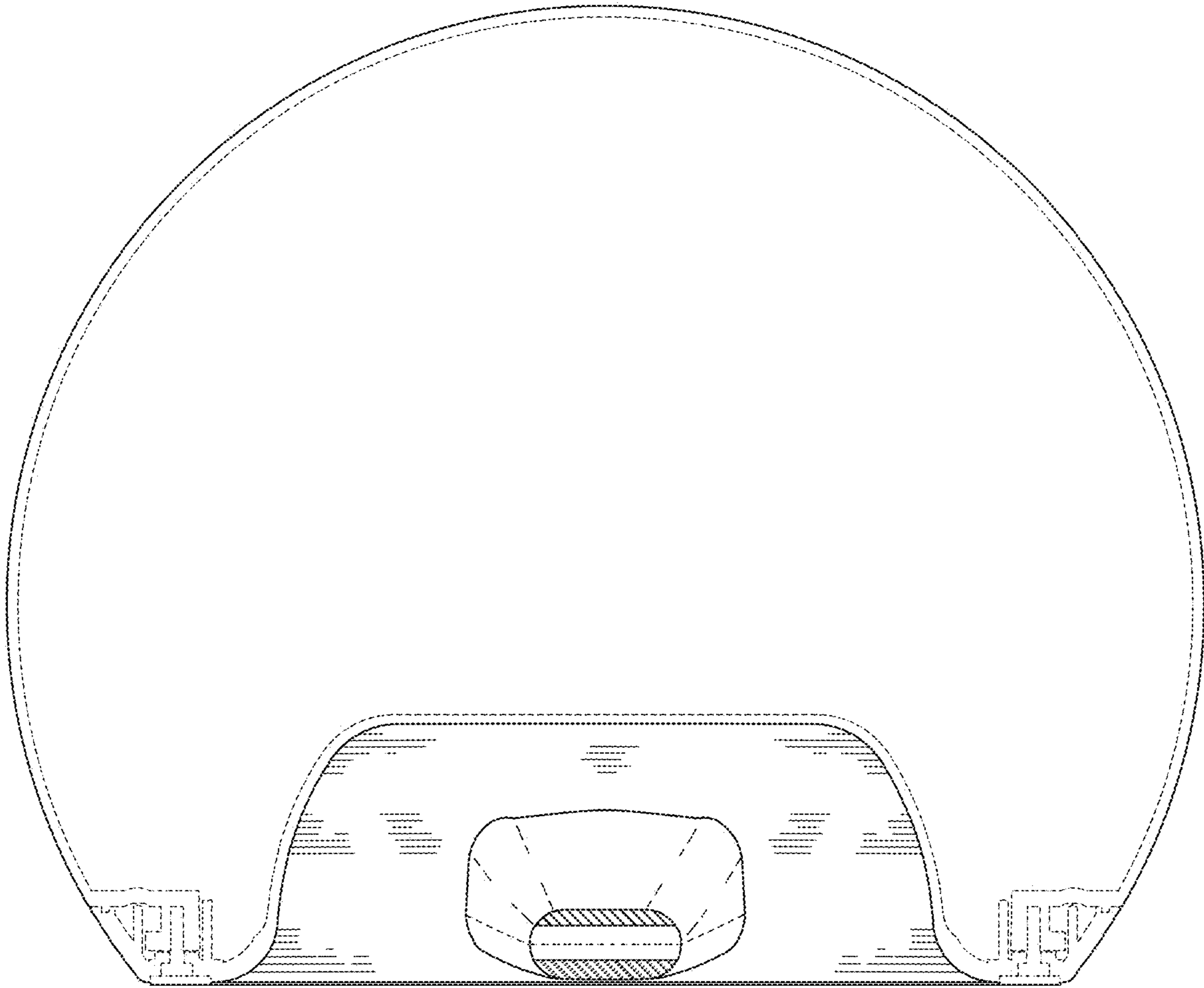

FIG. 23

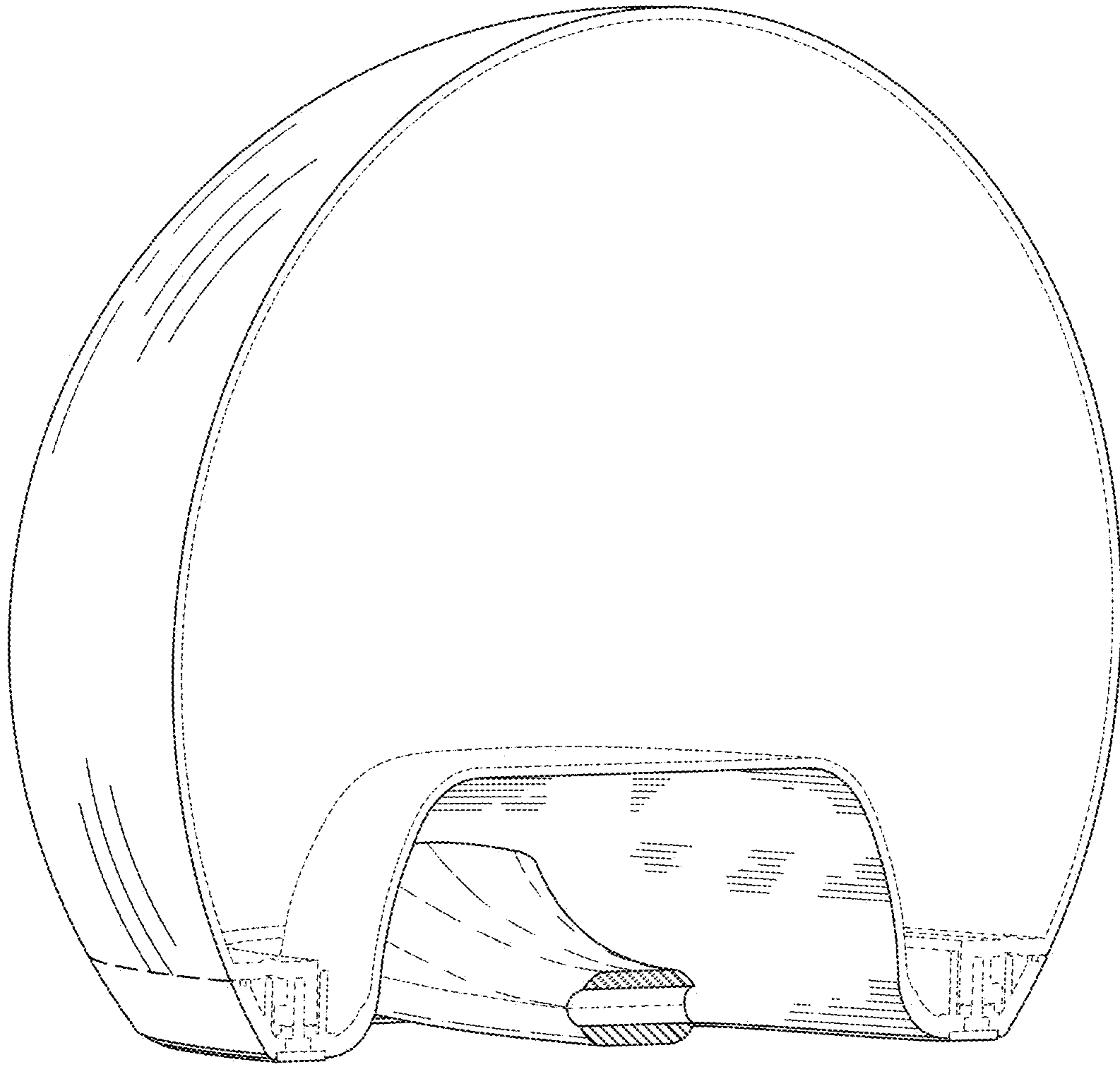

FIG. 24