



US00D968622S

(12) **United States Design Patent**
Robran

(10) **Patent No.:** **US D968,622 S**
(45) **Date of Patent:** **** Nov. 1, 2022**

(54) **MODULAR KNEE EXTENSION DEVICE**

(71) Applicant: **BONE FOAM, INC.**, Corcoran, MN (US)

(72) Inventor: **Chad L. Robran**, Plymouth, MN (US)

(73) Assignee: **Bone Foam, Inc.**, Corcoran, MN (US)

(**) Term: **15 Years**

(21) Appl. No.: **29/712,251**

(22) Filed: **Nov. 6, 2019**

(51) **LOC (13) Cl.** **24-02**

(52) **U.S. Cl.**
USPC **D24/190**

(58) **Field of Classification Search**

USPC D24/188-190, 145, 191, 192, 200, 211,
D24/212, 213, 214, 215, 107, 143,
D24/164-169, 206, 183; D6/596-604
CPC A47G 9/10; A47C 20/021; A47C 20/023;
A47C 20/026; A47C 20/027; A47C
16/00; A61G 7/0755; A61G 7/075; A61G
13/121; A61G 13/1235; A61F 5/0111;
A61F 5/0127; A61F 13/066; A61F 2/6607
See application file for complete search history.

(56) **References Cited**

U.S. PATENT DOCUMENTS

D318,923 S *	8/1991	Marsh	D24/183
D319,700 S *	9/1991	Michelson	D24/183
D321,562 S *	11/1991	Ljungvall	D24/183
D321,760 S *	11/1991	Carney	D24/190
D325,087 S *	3/1992	Brinker	D24/190
D328,349 S *	7/1992	Waldrop	D24/183
D336,134 S *	6/1993	Kalatsky	D24/190
D337,824 S *	7/1993	Campbell	D24/190
D342,856 S *	1/1994	Hagen	5/632
D343,001 S *	1/1994	Boland	D24/183
D345,797 S *	4/1994	Gardner	5/648
D347,476 S *	5/1994	McDonald	D24/190
D348,175 S *	6/1994	Kilbey	D24/190
D359,190 S *	6/1995	Hargest	5/650
D359,804 S *	6/1995	Carter	D24/183

D360,796 S *	8/1995	Goldado	5/648
D364,202 S *	11/1995	Benson	D21/686
D366,527 S *	1/1996	Paterson	D24/158
D366,801 S *	2/1996	Gray	5/648
D367,535 S *	2/1996	Stenberg	D24/190
D369,391 S *	4/1996	Jump, Jr.	D21/685
D370,066 S *	5/1996	Kennemore	D24/183
D370,820 S *	6/1996	Kilbey	D6/596
D384,850 S *	10/1997	Fanuzzi	D6/596
D386,643 S *	11/1997	Farrell	D6/596
5,687,742 A *	11/1997	Johnson	A61F 5/0585 5/650
D387,167 S *	12/1997	Klein	D24/183
D390,665 S *	2/1998	Kennemore	D24/183
D391,371 S *	2/1998	Coakley	5/636
D392,495 S *	3/1998	Baousson	D6/596
D392,830 S *	3/1998	Warner	D6/596
D399,968 S *	10/1998	Petersen	D24/190
D400,386 S *	11/1998	Keilhauer	D6/601
D413,980 S *	9/1999	Sioufi	D24/183
D413,981 S *	9/1999	Swedberg	D24/190
D413,982 S *	9/1999	Swedberg	D24/190
D414,368 S *	9/1999	Wingard	D6/601
D415,281 S *	10/1999	Swedberg	D24/183
6,032,669 A *	3/2000	Klein	A47C 20/021 128/845
D424,698 S *	5/2000	Ames	D24/183
D426,307 S *	6/2000	Swedberg	D24/183
D428,898 S *	8/2000	Hixson	D15/90
D431,143 S *	9/2000	Sekelsky	D6/601
D439,671 S *	3/2001	Casillo	D24/199
D447,568 S *	9/2001	Hall	D24/183
D456,906 S *	5/2002	Graham	5/630
D457,707 S *	5/2002	Smith	D2/706
D476,185 S *	6/2003	Siegal	D6/601
D516,726 S *	3/2006	Hoenecke	D24/183
D521,301 S *	5/2006	Dickson	D6/601
D543,064 S *	5/2007	Hale	D6/596
D543,214 S *	5/2007	Stewart	D14/460
D543,407 S *	5/2007	Thom	D6/604
D546,107 S *	7/2007	Babcock	D6/601
D548,479 S *	8/2007	Clark	D21/809
D549,826 S *	8/2007	Aoki	D24/158
D551,355 S *	9/2007	Tao	D24/200
D565,372 S *	4/2008	Stegmeier	D8/45
D565,734 S *	4/2008	Scott	D24/183
D569,000 S *	5/2008	Itonaga	D24/186
D573,830 S *	7/2008	Kalatsky	D6/601
D578,219 S *	10/2008	Daggett	D24/183
D578,355 S *	10/2008	Arney	D7/601
D580,230 S *	11/2008	Arney	D7/601
D581,715 S *	12/2008	Scheuch	D6/601
D587,507 S *	3/2009	Martin	D6/604

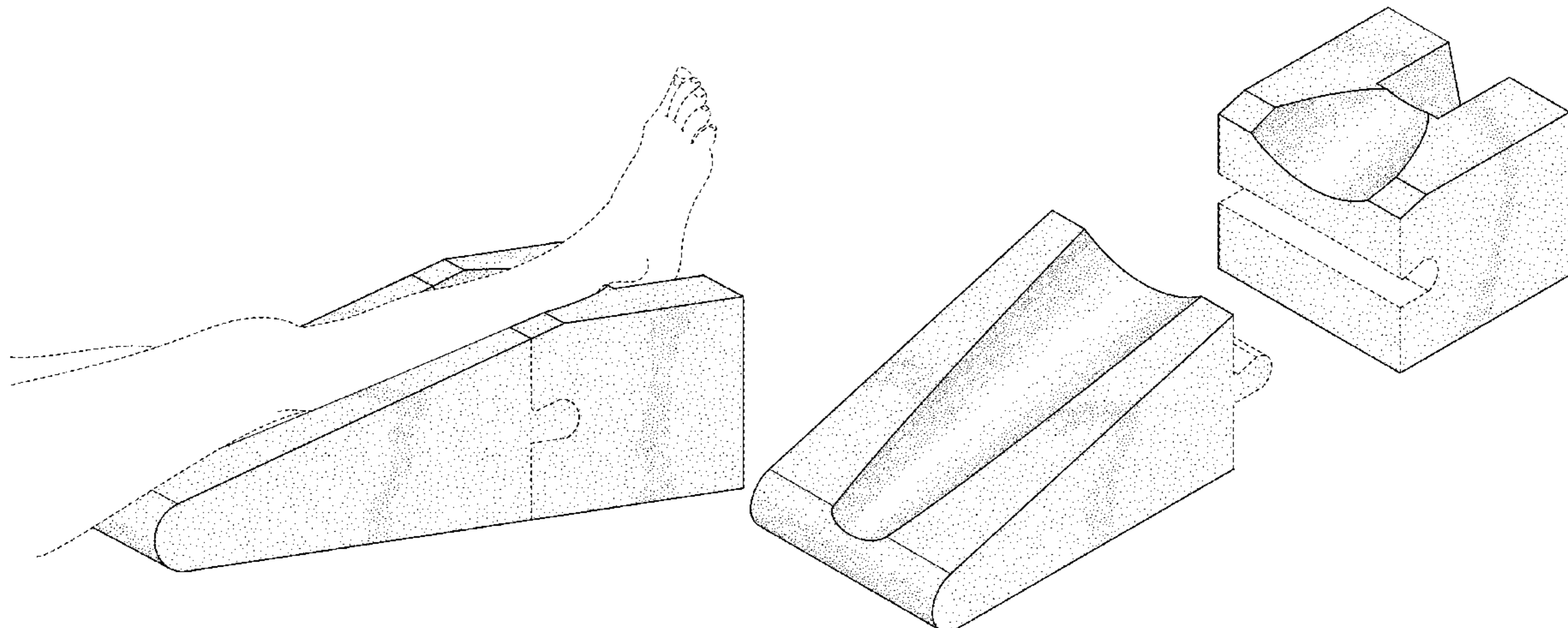

US D968,622 S

D595,725 S *	7/2009	Zuckerman	D14/461	D769,026 S *	10/2016	Weiss	D6/596
D598,106 S *	8/2009	Goumas	D24/184	D771,414 S *	11/2016	Krishtul	D6/601
D601,261 S *	9/2009	Levan	D24/184	9,510,686 B2 *	12/2016	Abraham	A47C 20/026
D610,852 S *	3/2010	Rothschild	D6/601	D779,236 S *	2/2017	Ribble	A61G 7/018
D618,354 S *	6/2010	Francucci	D24/183				D6/605
D618,943 S *	7/2010	Gold	D6/596	D781,073 S *	3/2017	Kashierski	D6/601
D625,421 S *	10/2010	Sharps	D24/184	D781,429 S *	3/2017	Westdyk	D24/190
D631,109 S *	1/2011	Morin	D21/694	D783,313 S *	4/2017	Trubac	D6/601
D639,876 S *	6/2011	Tsou	D21/686	D783,834 S *	4/2017	Johnson	D24/184
D642,278 S *	7/2011	Sharps	D24/184	D787,072 S *	5/2017	Pryce-Jones	D24/183
D642,280 S *	7/2011	Goumas	D24/190	D791,509 S *	7/2017	Jones	D6/601
D642,412 S *	8/2011	Cuba	D6/601	D793,769 S *	8/2017	Nacey	D6/601
D642,694 S *	8/2011	Sharps	D24/190	D800,480 S *	10/2017	Paperno	A47D 13/08
D649,253 S *	11/2011	Held	D24/183				D6/596
D652,935 S *	1/2012	Held	D24/183	D800,852 S *	10/2017	Flook	D21/671
D655,559 S *	3/2012	Cheng	D6/601	D804,850 S *	12/2017	Acosta De Nicolo	D6/601
D656,356 S *	3/2012	Cheng	D6/601	D805,206 S *	12/2017	Hill	D24/184
D657,468 S *	4/2012	Held	D24/184	D805,325 S *	12/2017	Chan	D6/601
D658,421 S *	5/2012	Williams	D6/604	D807,080 S *	1/2018	Abernethy, Jr.	D6/601
D660,856 S *	5/2012	Josefek	D14/461	D807,694 S *	1/2018	Jewett	D7/397
D664,148 S *	7/2012	Josefek	D14/459	D807,973 S *	1/2018	Leonardo	D21/686
D664,256 S *	7/2012	Dennewald	D24/183	D808,195 S *	1/2018	Wyborn	D6/601
D665,503 S *	8/2012	Dennewald	D24/183	D808,532 S *	1/2018	Richey	D24/183
D666,025 S *	8/2012	Cobbett	D6/682.1	D815,294 S *	4/2018	Bartolotta	D24/190
D666,026 S *	8/2012	Alvarez	D6/682.3	9,968,375 B2 *	5/2018	Kao	A61G 13/0009
D673,684 S *	1/2013	Piermarini	D24/183	D821,780 S *	7/2018	Strandberg	D6/596
D675,267 S *	1/2013	Jamison, Jr.	D21/686	D822,410 S *	7/2018	Berry, Jr.	D6/604
D680,654 S *	4/2013	Borrelli	D24/188	D823,479 S *	7/2018	Mollohan	D24/215
D681,751 S *	5/2013	Meyer-Hayoz	D21/686	D824,467 S *	7/2018	Rademacher	D21/803
D681,994 S *	5/2013	Morgan, II	D6/601	D824,601 S *	7/2018	Fallgatter	D29/124
D690,308 S *	9/2013	McCoy	D14/458	10,022,001 B1 *	7/2018	Hawkins	A47C 7/383
D693,164 S *	11/2013	Caforio	D6/716	D824,695 S *	8/2018	Campilii	D6/601
D697,326 S *	1/2014	De Ridder	D6/349	D831,385 S *	10/2018	Wyborn	D6/601
D698,030 S *	1/2014	Crisco	D24/190	D831,761 S *	10/2018	Stricklin	D21/688
D701,710 S *	4/2014	Martinez	D6/601	D833,628 S *	11/2018	Davis	D24/190
D702,980 S *	4/2014	Caforio	D6/716.1	D837,799 S *	1/2019	Chan	D14/451
8,713,732 B2 *	5/2014	Dennewald	A47G 9/1081	D838,054 S *	1/2019	Franson	D29/121.1
			5/636	D838,122 S *	1/2019	Faniku	D6/596
D707,358 S *	6/2014	Mantilla	D24/184	D838,580 S *	1/2019	Apple	D8/374
D708,752 S *	7/2014	Oberst	D24/190	10,188,575 B2 *	1/2019	Norstrem	A61H 1/0296
D710,999 S *	8/2014	Gurall	D24/183	D841,819 S *	2/2019	Clark	D24/183
D711,000 S *	8/2014	Ravikumar	D24/184	10,226,551 B2 *	3/2019	Richey	A61L 31/18
D712,556 S *	9/2014	Abbey	A42B 3/0473	D845,035 S *	4/2019	Raad	D6/601
			D24/191	D846,312 S *	4/2019	Davis	D6/601
D713,665 S *	9/2014	Caforio	D6/716.1	D846,744 S *	4/2019	Simson	D24/184
D718,456 S *	11/2014	McNamee	D24/171	10,271,981 B2 *	4/2019	Raniere	A61F 5/012
D720,145 S *	12/2014	Pierre	D6/361	D848,763 S *	5/2019	Potter	D6/601
D721,465 S *	1/2015	Heinz	B62B 3/02	10,357,419 B2 *	7/2019	Zilkha	A61H 1/02
			D34/35	D856,706 S *	8/2019	Moffett	D6/601
D728,165 S *	4/2015	Davis	D29/121.2	D858,779 S *	9/2019	Durfee	D24/190
D728,270 S *	5/2015	Hauer	D6/601	D859,664 S *	9/2019	Dennewald	D24/183
D728,799 S *	5/2015	Ravikumar	D24/184	D859,668 S *	9/2019	Durfee	D24/190
D731,817 S *	6/2015	Rogers	D6/601	D863,824 S *	10/2019	Comercio	D6/601
D732,174 S *	6/2015	Johnson	D24/184	D864,318 S *	10/2019	Szonyi	D21/686
D732,312 S *	6/2015	Tiffin	D6/601	D864,612 S *	10/2019	Castellano	D6/601
D732,671 S *	6/2015	Moy	D24/184	D868,500 S *	12/2019	Rowe	D6/601
D733,897 S *	7/2015	Rossouw	D24/190	D869,666 S *	12/2019	Michaud	D24/188
D734,545 S *	7/2015	Cantu	D28/57	D871,593 S *	12/2019	Rossouw	D24/190
D736,391 S *	8/2015	Johnson	D24/184	D872,199 S *	1/2020	Krishock	D21/686
D736,397 S *	8/2015	McAviney	D24/211	D872,504 S *	1/2020	Toft	D6/601
D736,542 S *	8/2015	Fenton	A47C 20/02	D874,011 S *	1/2020	John	D24/190
			D6/601	D875,412 S *	2/2020	Davis, III	D6/361
D739,036 S *	9/2015	McAviney	D24/211	D875,437 S *	2/2020	Nicholson	D6/601
D741,621 S *	10/2015	Van Grieken	D6/601	D875,949 S *	2/2020	Clark	D24/183
D741,962 S *	10/2015	Terrian	D21/686	10,575,665 B2 *	3/2020	Rosenberg	A47G 9/1081
D748,931 S *	2/2016	Corigliano	D6/601	D880,877 S *	4/2020	Zavala	D6/330
D749,873 S *	2/2016	Latrofa	D6/601	D880,901 S *	4/2020	Raad	D6/601
D752,358 S *	3/2016	Pribyl	D6/595	D882,296 S *	4/2020	Huang	D6/601
D752,359 S *	3/2016	Lee	D6/601	10,617,584 B1 *	4/2020	Moudy	A61G 7/0755
9,271,581 B2 *	3/2016	Williams	A47D 13/083	D883,713 S *	5/2020	Glatt	D6/601
9,289,344 B2 *	3/2016	Pi	A61G 13/1215	D885,589 S *	5/2020	Marcil	D24/190
D755,543 S *	5/2016	Upadhyay	D6/601	10,660,817 B2 *	5/2020	Johnson	A61H 1/0292
D756,687 S *	5/2016	Durkin	D6/601	D886,991 S *	6/2020	Kindler	D24/128
D758,098 S *	6/2016	Pham	D6/601	D886,992 S *	6/2020	Kindler	D24/128
D759,406 S *	6/2016	Peterson	D6/601	D896,550 S *	9/2020	Cane	D6/601
D759,825 S *	6/2016	Johnson	D24/184	D898,430 S *	10/2020	Kulik	D6/601
9,427,366 B2 *	8/2016	Melcher	A47C 20/023	D898,443 S *	10/2020	Romano	D6/601
D767,148 S *	9/2016	Perreault	D24/183	D898,444 S *	10/2020	Chen	D6/601
9,433,309 B2 *	9/2016	Cheng	A47G 9/109	D899,141 S *	10/2020	Du	D6/601

D899,536	S	*	10/2020	Endelman	D21/686
D902,488	S	*	11/2020	Song	D28/56
D902,489	S	*	11/2020	Song	D28/56
10,835,063	B2	*	11/2020	Bourgeois	A47G 9/1009
D904,074	S	*	12/2020	Yang	D6/601
10,857,061	B2	*	12/2020	Alexander	A61H 1/008
D906,733	S	*	1/2021	Graham	D6/601
D907,777	S	*	1/2021	Hahn	D24/171
D907,781	S	*	1/2021	Moudy	A61G 7/057 D24/184
D907,941	S	*	1/2021	Chanfrau, IV	D6/601
D908,392	S	*	1/2021	Despen	D6/601
D908,393	S	*	1/2021	Yang	D6/601
10,881,226	B1	*	1/2021	Ou	A47G 9/10
D910,339	S	*	2/2021	Dennewald	D6/601
D911,069	S	*	2/2021	Lin	D6/601
D911,072	S	*	2/2021	Moore	A61F 5/37 D6/601
D911,748	S	*	3/2021	Luo	D6/601
D911,750	S	*	3/2021	Chiang	A61F 5/37 D6/604
D913,725	S	*	3/2021	Yan	D6/601
D915,792	S	*	4/2021	Shi	D6/601
D916,527	S	*	4/2021	Feng	D6/601
D920,006	S	*	5/2021	Yan	D6/601
11,013,336	B2	*	5/2021	Langer	A61G 7/05715
D921,203	S	*	6/2021	Clark	D24/183
D921,399	S	*	6/2021	Michover	D6/601
D923,189	S	*	6/2021	Cai	D24/213
D923,358	S	*	6/2021	Leverett	D6/601
D923,807	S	*	6/2021	Long	D24/213
D923,972	S	*	7/2021	Ou	D6/601
D924,341	S	*	7/2021	Stotter	D21/686
D924,601	S	*	7/2021	Lian	D6/601
D925,947	S	*	7/2021	Howard	D6/596
D925,948	S	*	7/2021	Feng	D6/601
D927,225	S	*	8/2021	Wang	D6/601
D928,968	S	*	8/2021	Robran	D24/184
D936,229	S	*	11/2021	Szparski	D6/601
D941,059	S	*	1/2022	Xiaoping	D6/601
D943,311	S	*	2/2022	Szparski	D6/601
D943,752	S	*	2/2022	Watters, III	D24/190
D944,037	S	*	2/2022	Yang	D6/601
D948,060	S	*	4/2022	Szparski	D24/190
D950,067	S	*	4/2022	Grindstaff	D24/190
D950,068	S	*	4/2022	Grindstaff	D24/190
D950,073	S	*	4/2022	Langer	D24/188
D950,665	S	*	5/2022	Rademacher	D21/803
D953,539	S	*	5/2022	Szparski	D24/183
2016/0331574	A1	*	11/2016	Lucey	A61F 5/37
2018/0008499	A1	*	1/2018	Lucey	A61G 7/0755
2020/0060428	A1	*	2/2020	Langer	A61F 5/01
2020/0060917	A1	*	2/2020	Lucey	A61F 5/37
2020/0397608	A1	*	12/2020	Roban	A61G 13/125
2021/0077287	A1	*	3/2021	Robran	A61F 5/0116
2021/0186738	A1	*	6/2021	Robran	A61F 5/3776

OTHER PUBLICATIONS

Knee Elevator, [site visited Aug. 17, 2021]. Available from Internet.
URL: <https://www.bonefoam.com/product/knee-elevator/> (Year: 2021).*

* cited by examiner

Primary Examiner — T Chase Nelson

Assistant Examiner — Kelly L Gross

(74) Attorney, Agent, or Firm — Workman Nydegger

(57)

CLAIM

The ornamental design for a modular knee extension device, as shown and described.

DESCRIPTION

FIG. 1 illustrates a perspective view of an exemplary use of a modular knee extension device showing an embodiment of the design, the modular knee extension device illustrated in a flat, supine configuration.

FIG. 2 illustrates a top, right perspective view thereof;

FIG. 3 illustrates a front elevation view thereof;

FIG. 4 illustrates a rear elevation view thereof;

FIG. 5 illustrates a bottom plan view thereof;

FIG. 6 illustrates a top plan view thereof;

FIG. 7 illustrates a right side elevation view thereof;

FIG. 8 illustrates a left side elevation view thereof;

FIG. 9 illustrates a top, right perspective view of the modular knee extension device disassembled in a flat, supine configuration;

FIG. 10 illustrates a front elevation view thereof;

FIG. 11 illustrates a rear elevation view thereof;

FIG. 12 illustrates a top plan view thereof;

FIG. 13 illustrates a bottom plan view thereof;

FIG. 14 illustrates a right side elevational view thereof;

FIG. 15 illustrates a left side elevational view thereof;

FIG. 16 illustrates a top, right perspective view of a first section of the modular knee extension device, the first section of a modular knee extension device illustrated in a flat, supine configuration;

FIG. 17 illustrates a front elevational view thereof;

FIG. 18 illustrates a rear elevational view thereof;

FIG. 19 illustrates a top plan view thereof;

FIG. 20 illustrates a bottom plan view thereof;

FIG. 21 illustrates a right side elevational view thereof;

FIG. 22 illustrates a left side elevational view thereof;

FIG. 23 illustrates a perspective view of an exemplary use of a second section of the modular knee extension device, the second section of the modular knee extension device illustrated in a flat, supine position;

FIG. 24 illustrates a top, right perspective view of the second section of the modular knee extension device, the second section of a modular knee extension device illustrated in a flat, supine configuration;

FIG. 25 illustrates a front elevational view thereof;

FIG. 26 illustrates a rear elevational view thereof;

FIG. 27 illustrates a top plan view thereof;

FIG. 28 illustrates a bottom plan view thereof;

FIG. 29 illustrates a right side elevational view thereof; and,

FIG. 30 illustrates a left side elevational view thereof.

In the drawings, the broken lines of FIG. 1 and FIG. 23 showing a human figure is for the purpose of illustrating a potential environment of the embodiment incorporating the new design and therefore form no part of the claimed design. The broken lines shown throughout the drawings illustrate portions of the modular knee extension device and form no part of the claimed design.

1 Claim, 13 Drawing Sheets

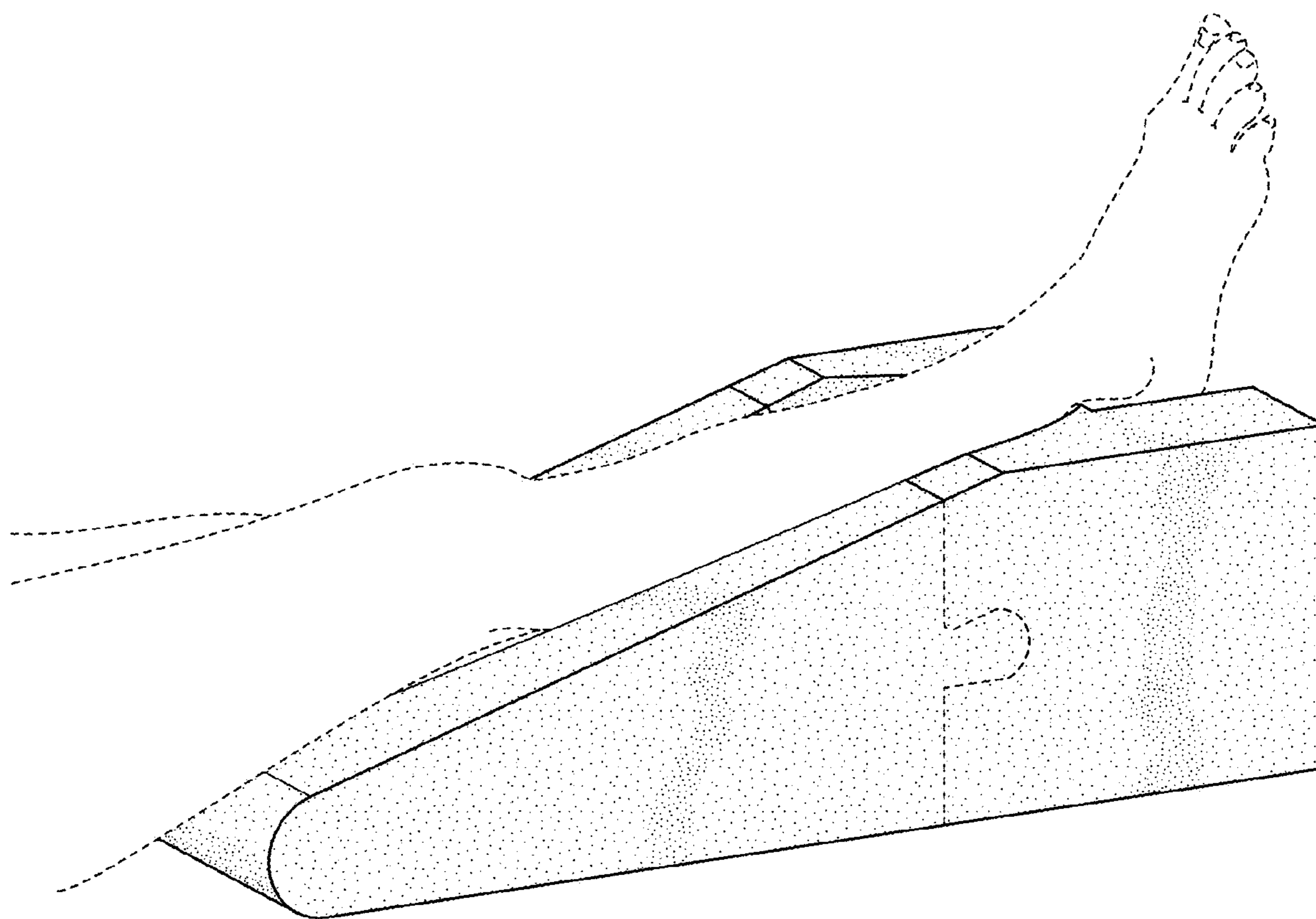

FIG. 1

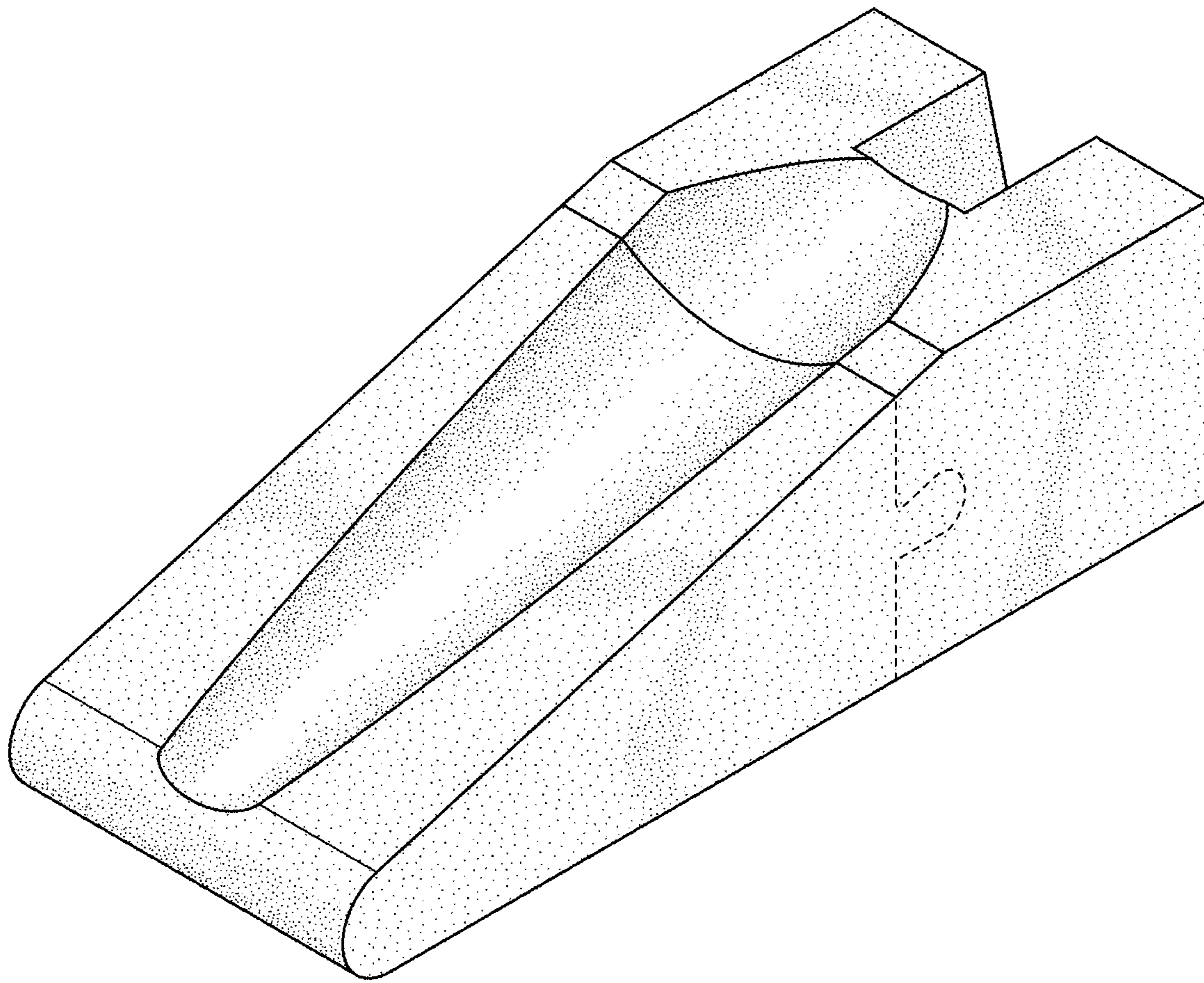

FIG. 2

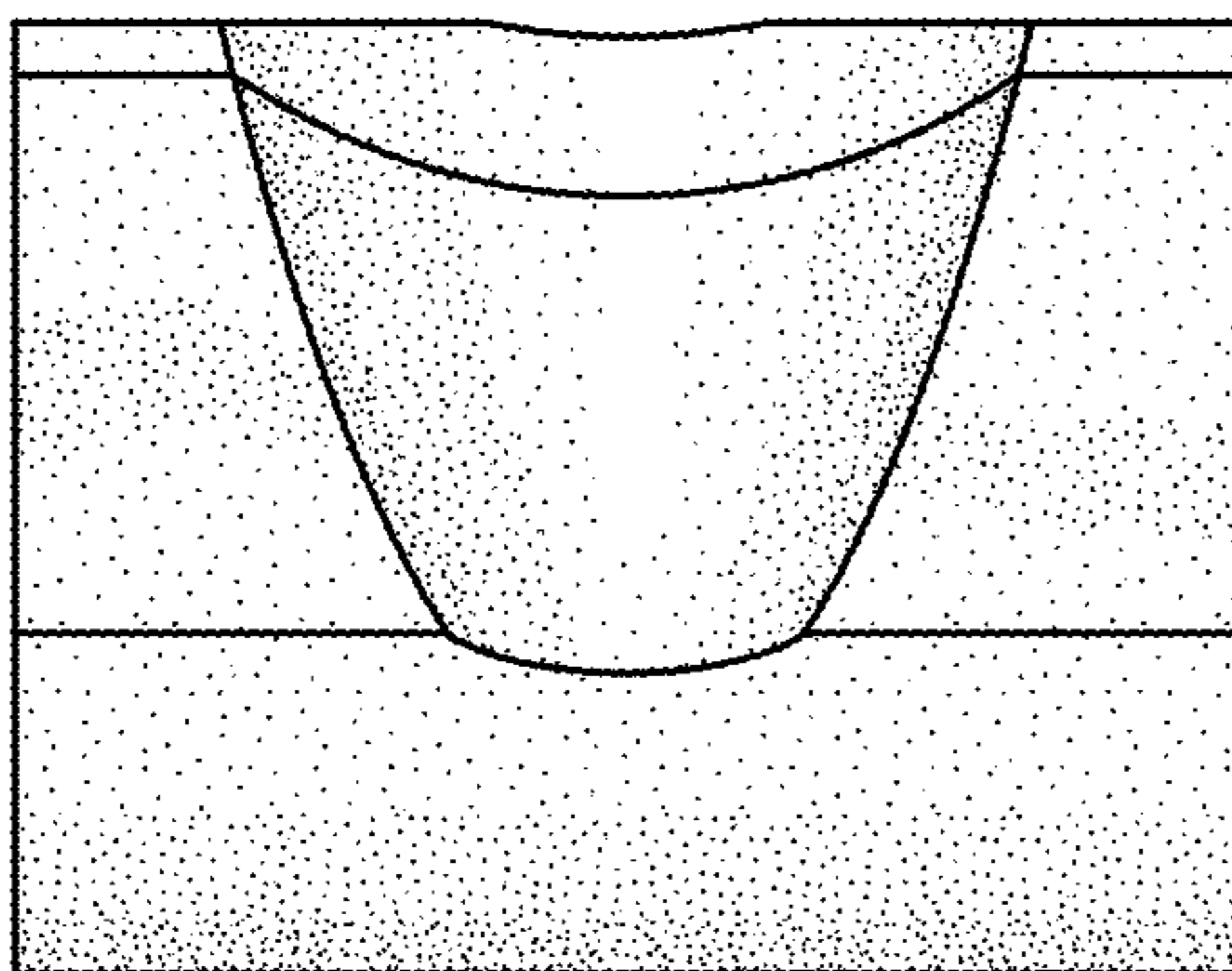

FIG. 3

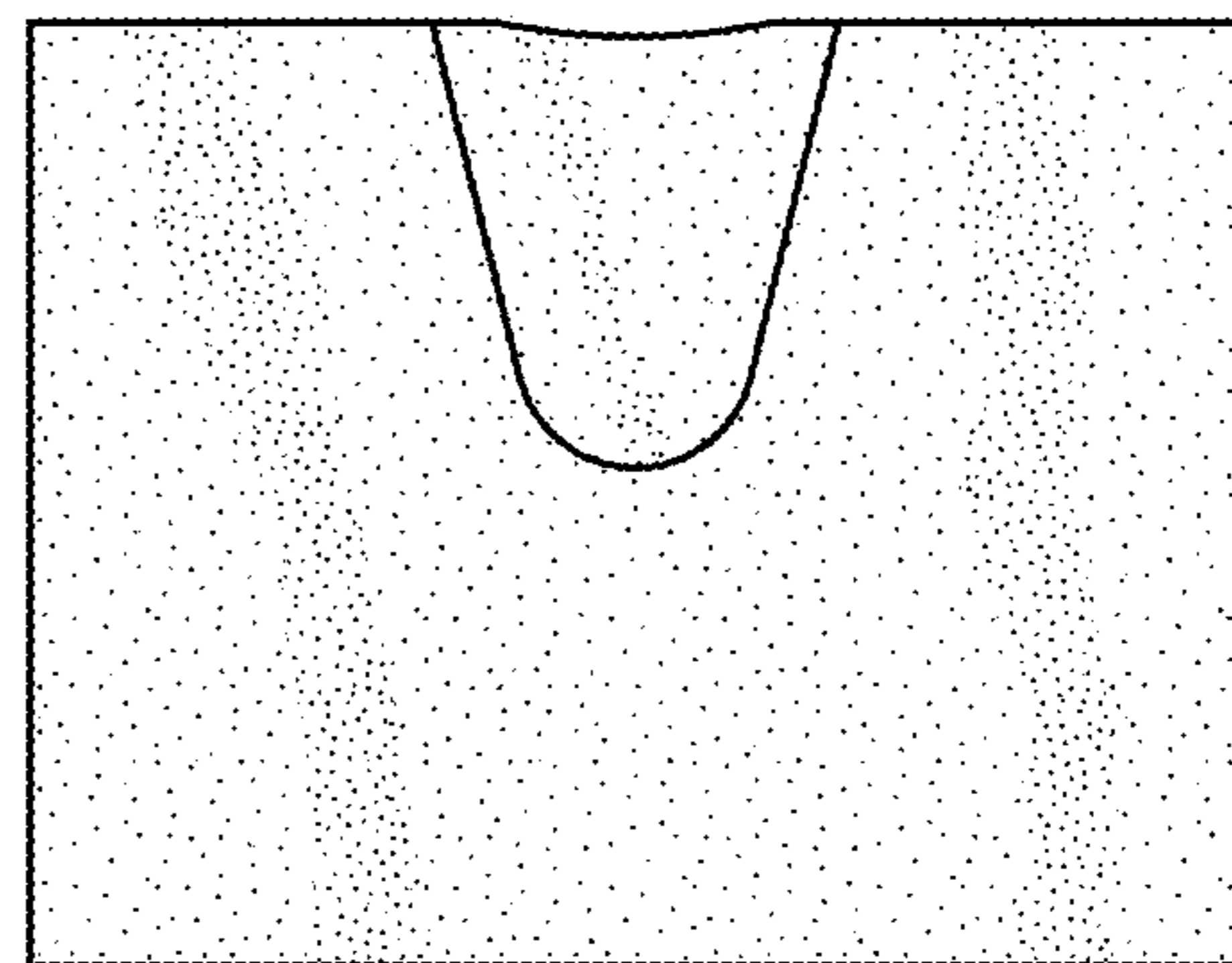

FIG. 4

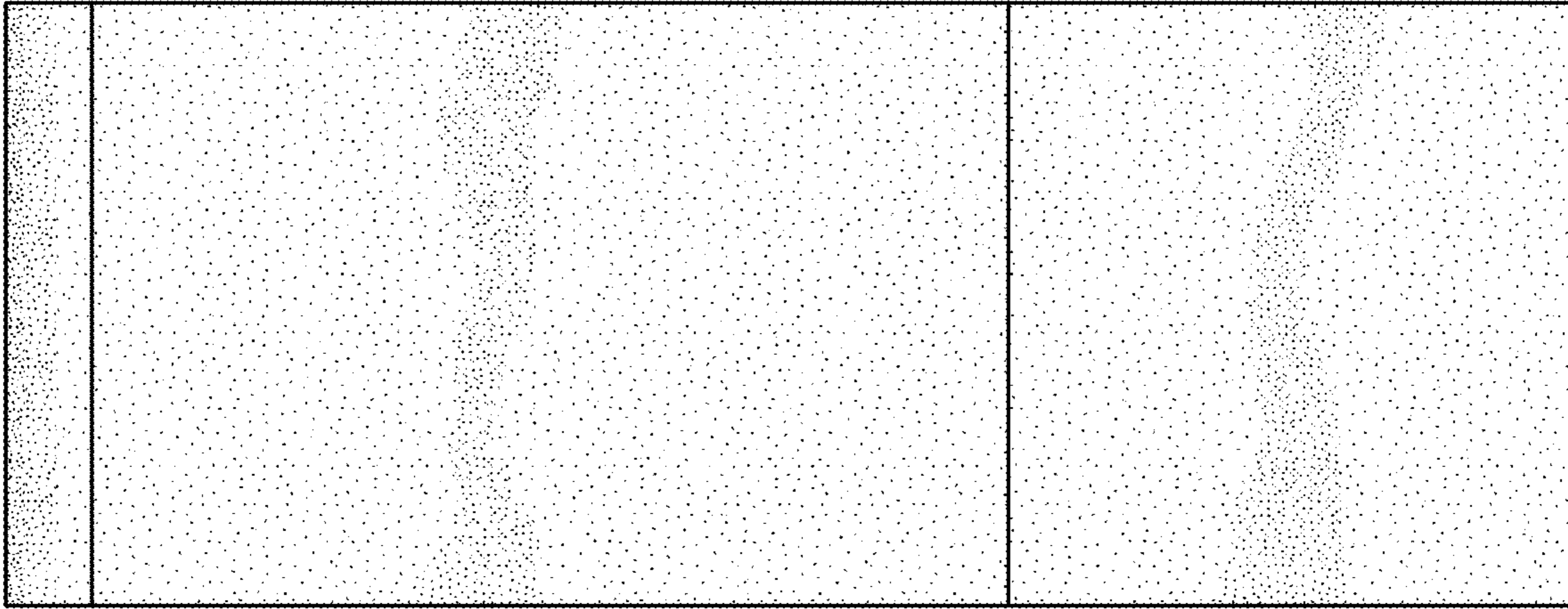

FIG. 5

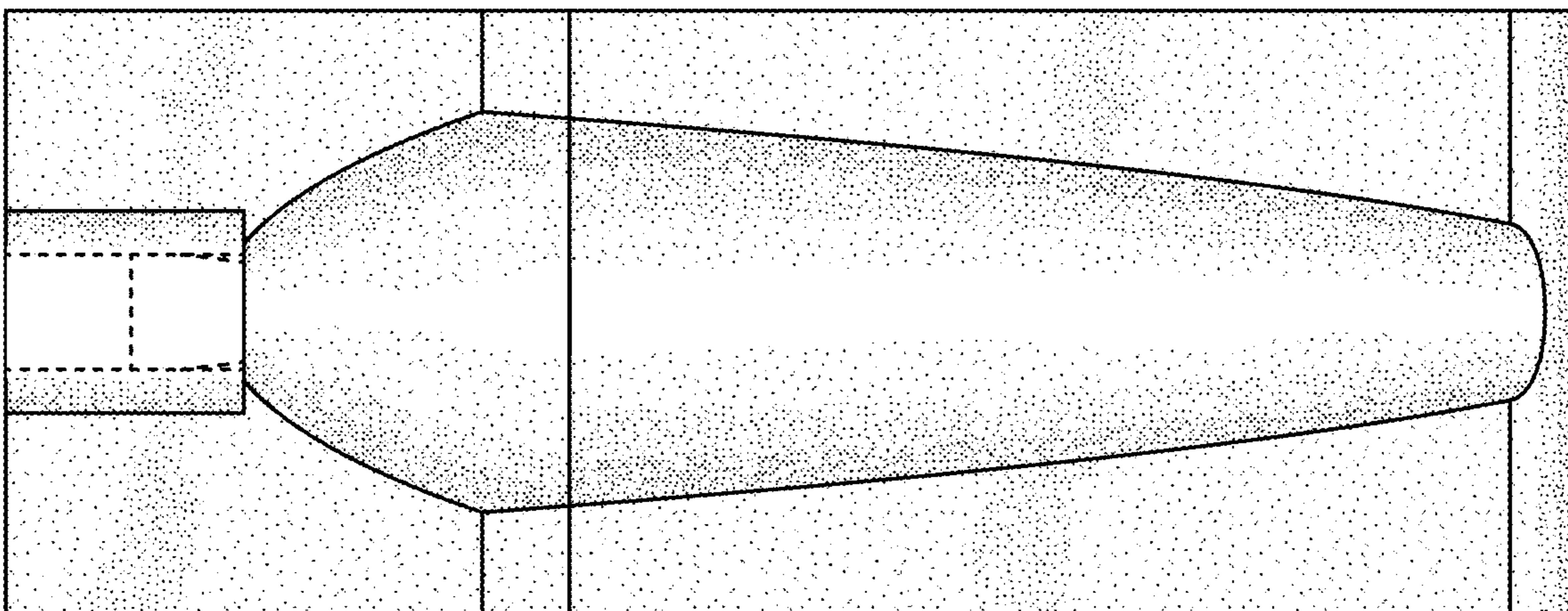

FIG. 6

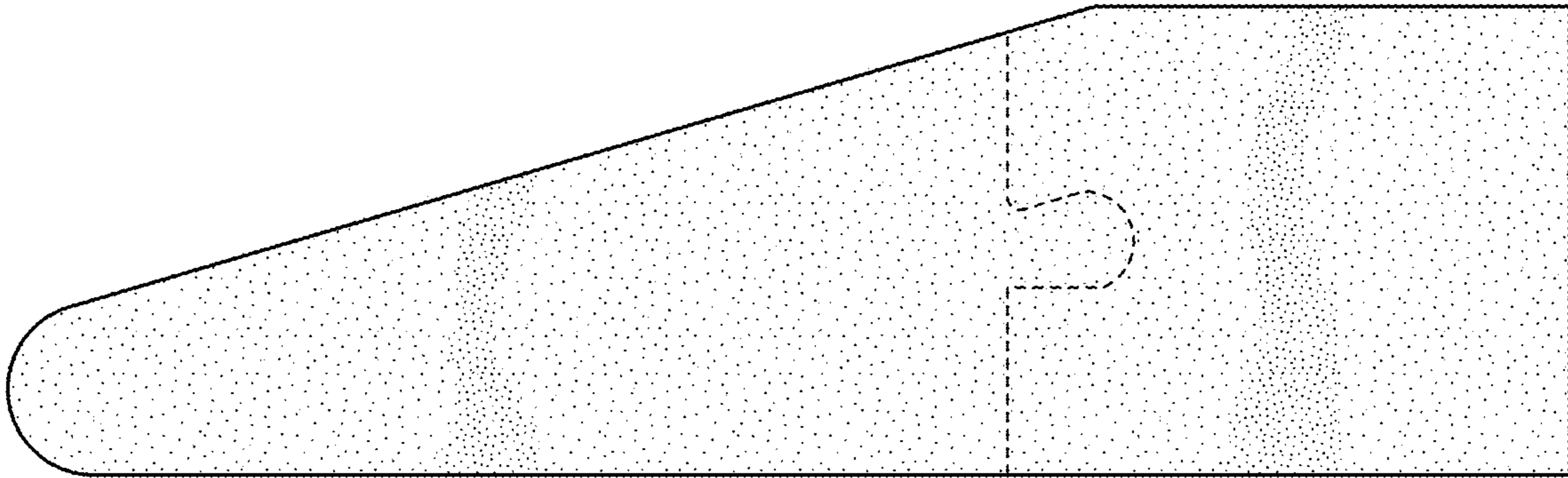

FIG. 7

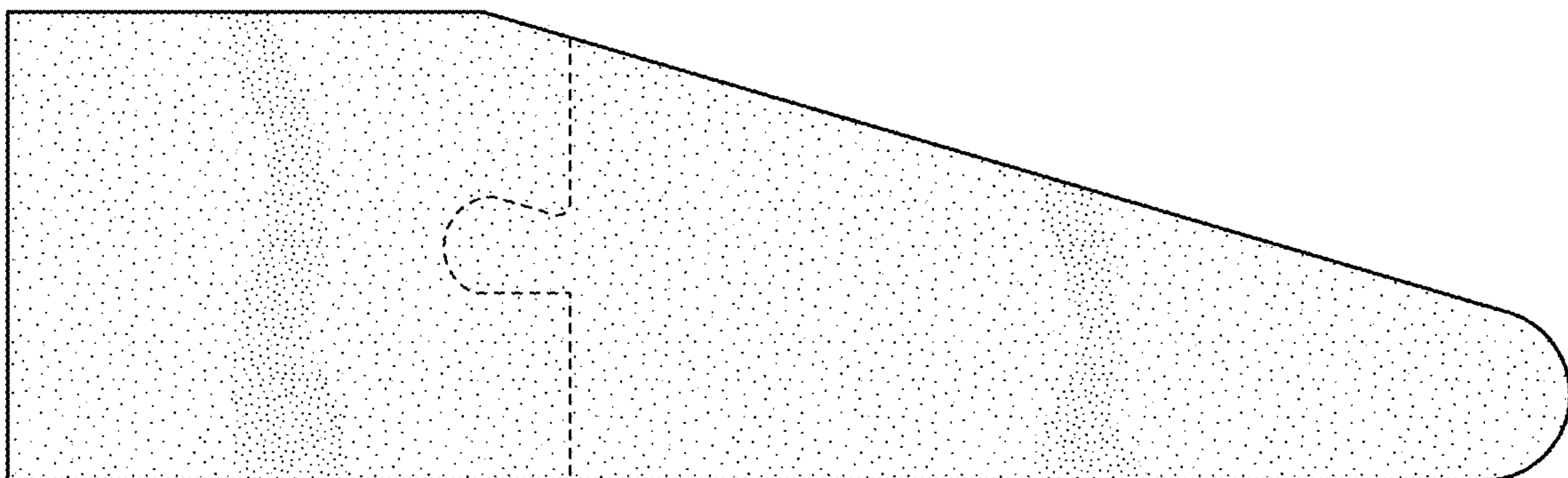

FIG. 8

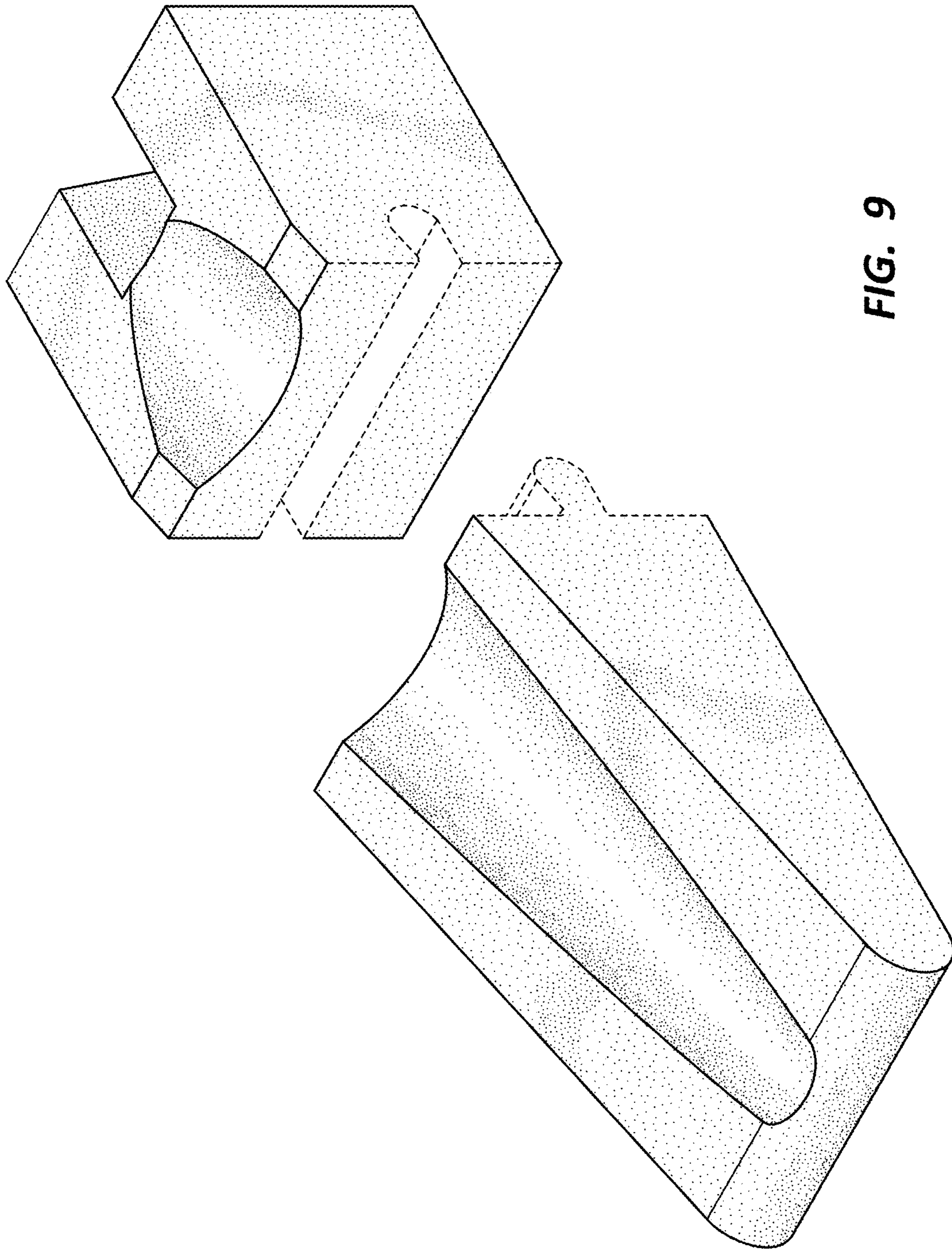

FIG. 9

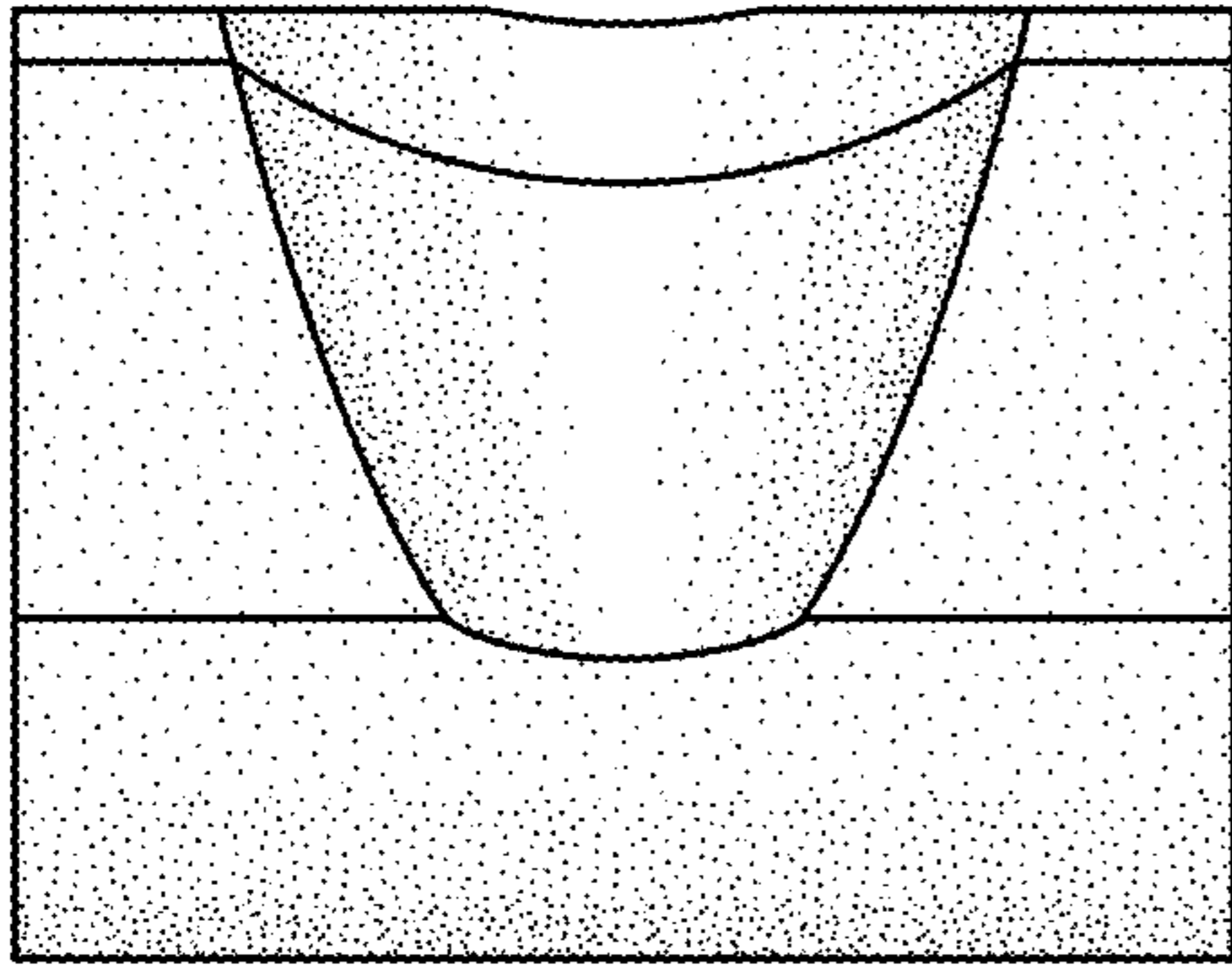

FIG. 10

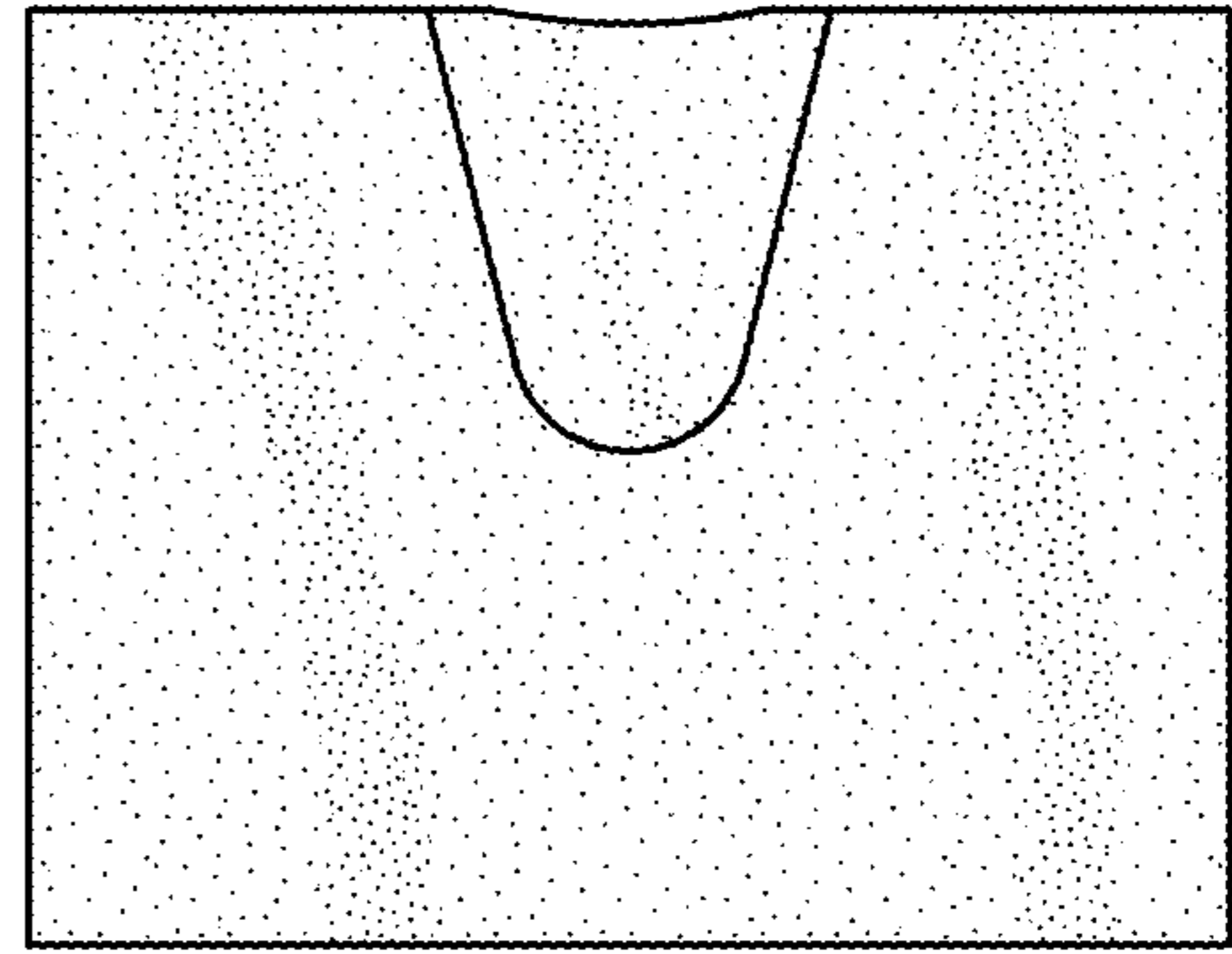

FIG. 11

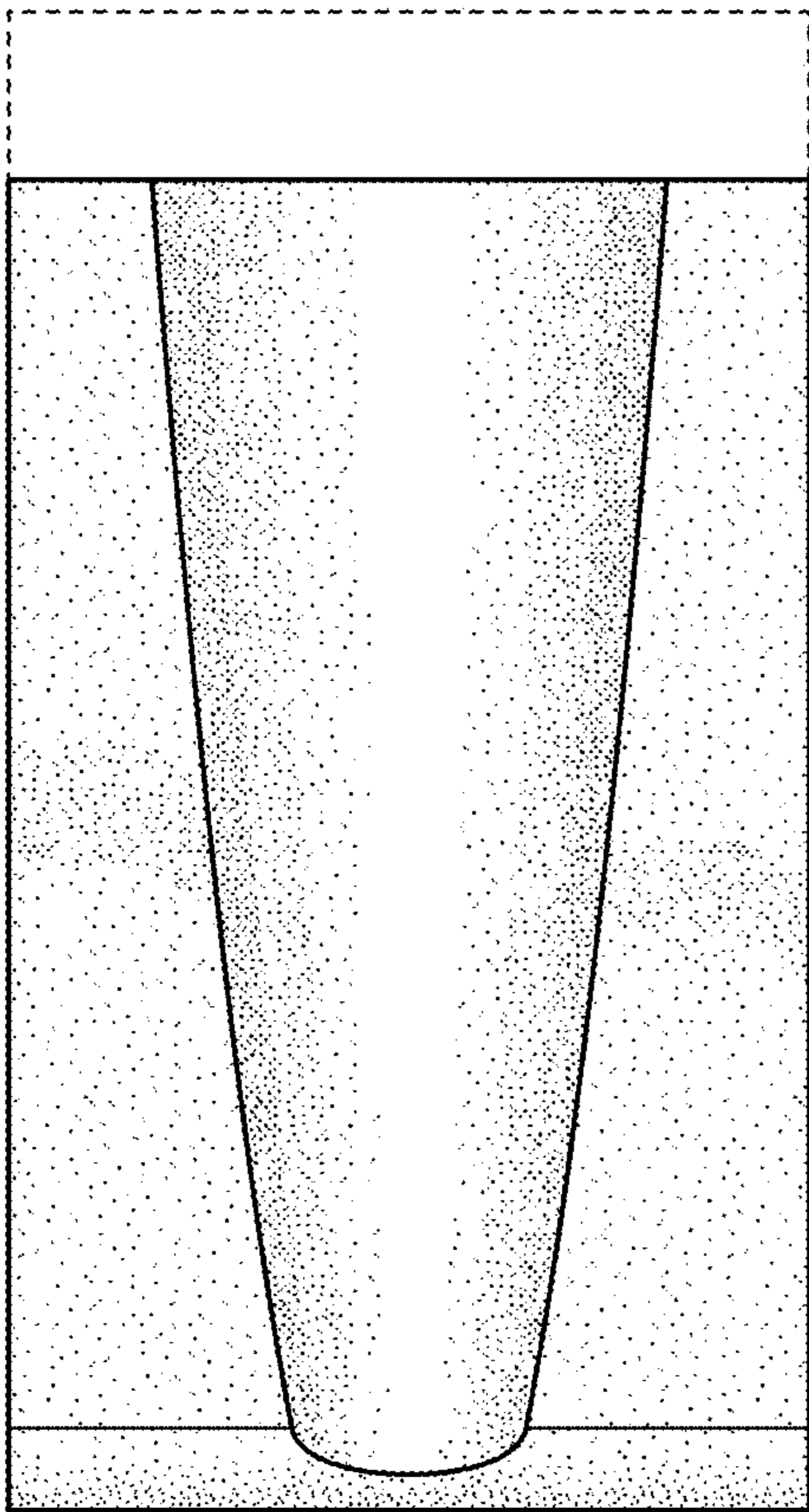
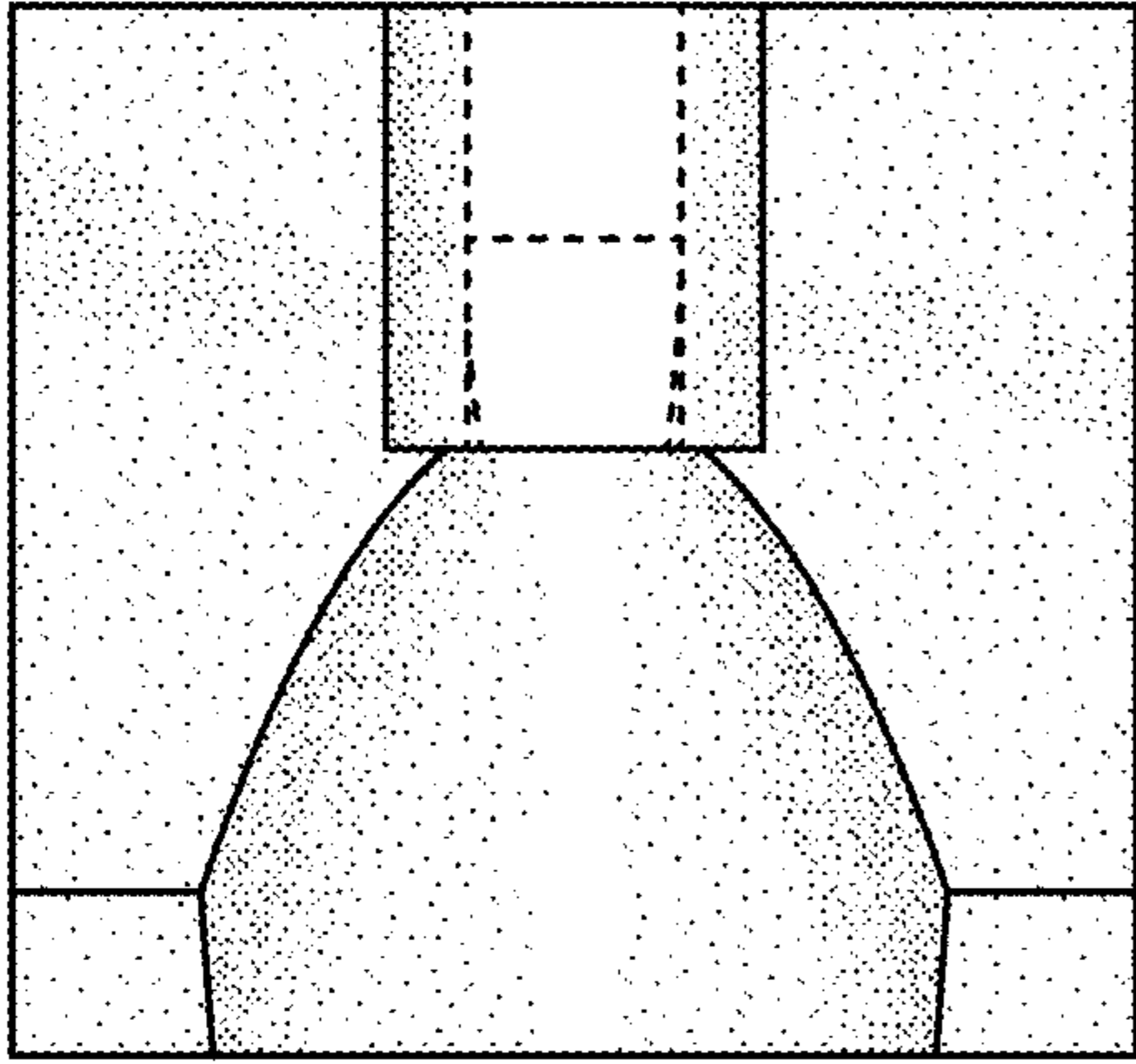

FIG. 12

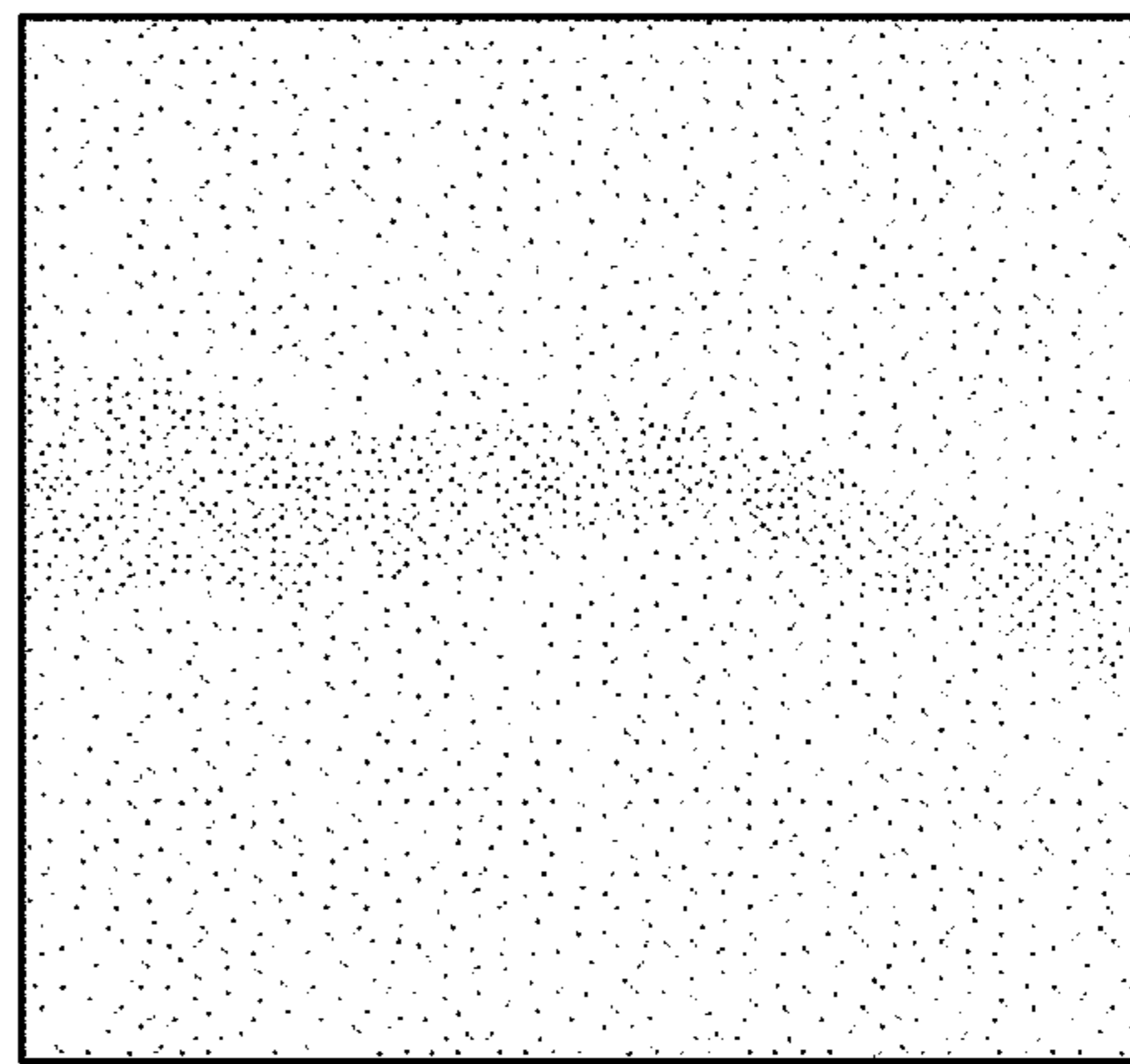
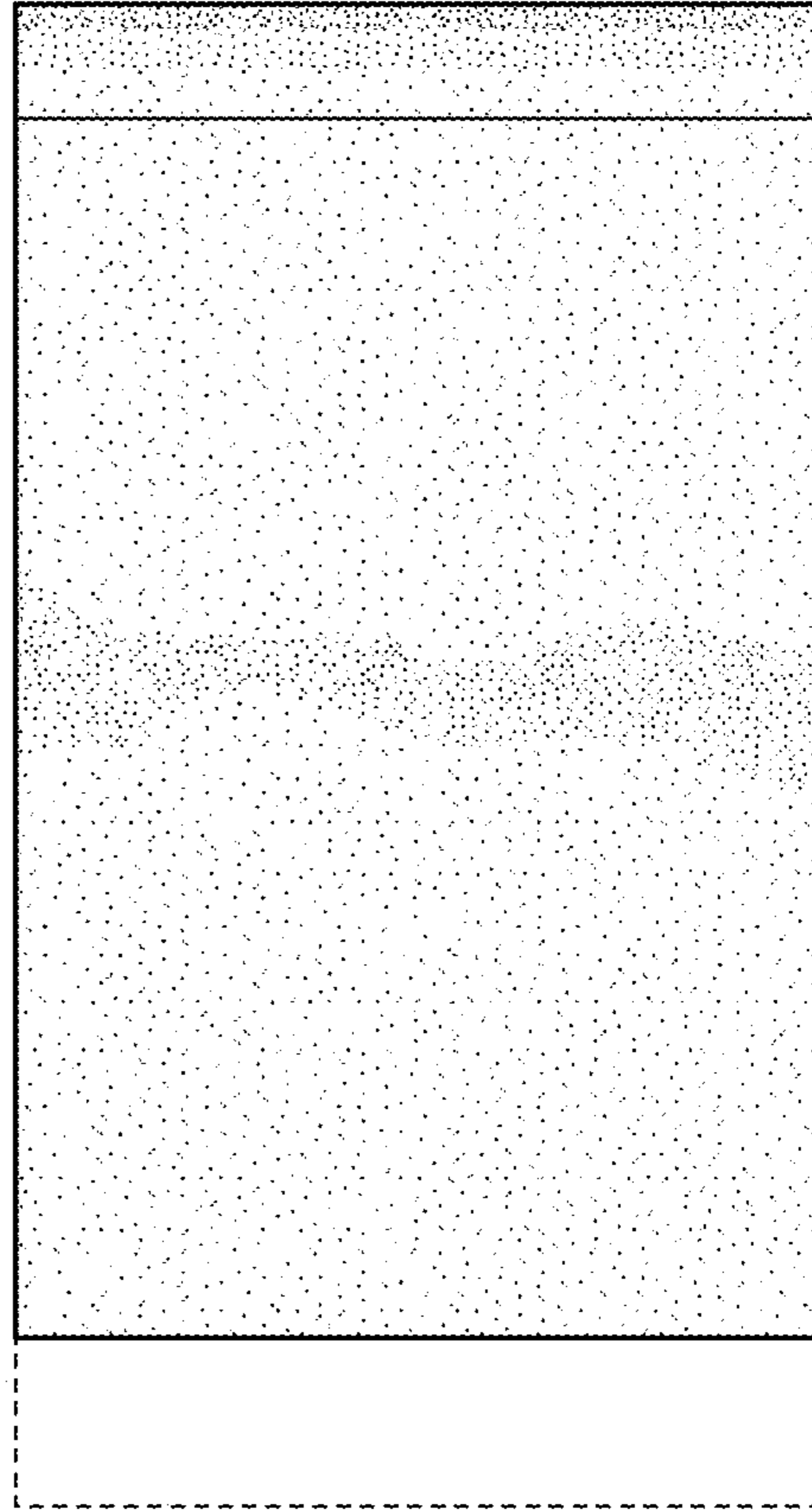

FIG. 13

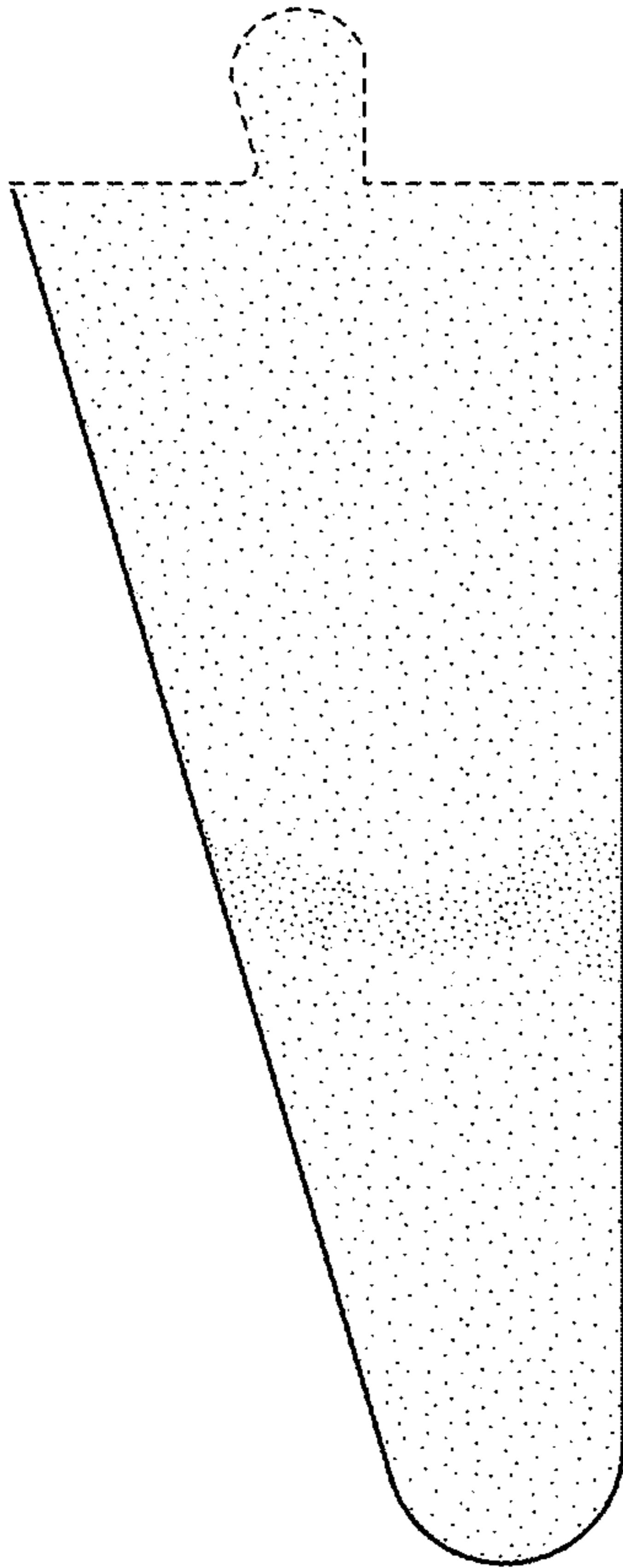
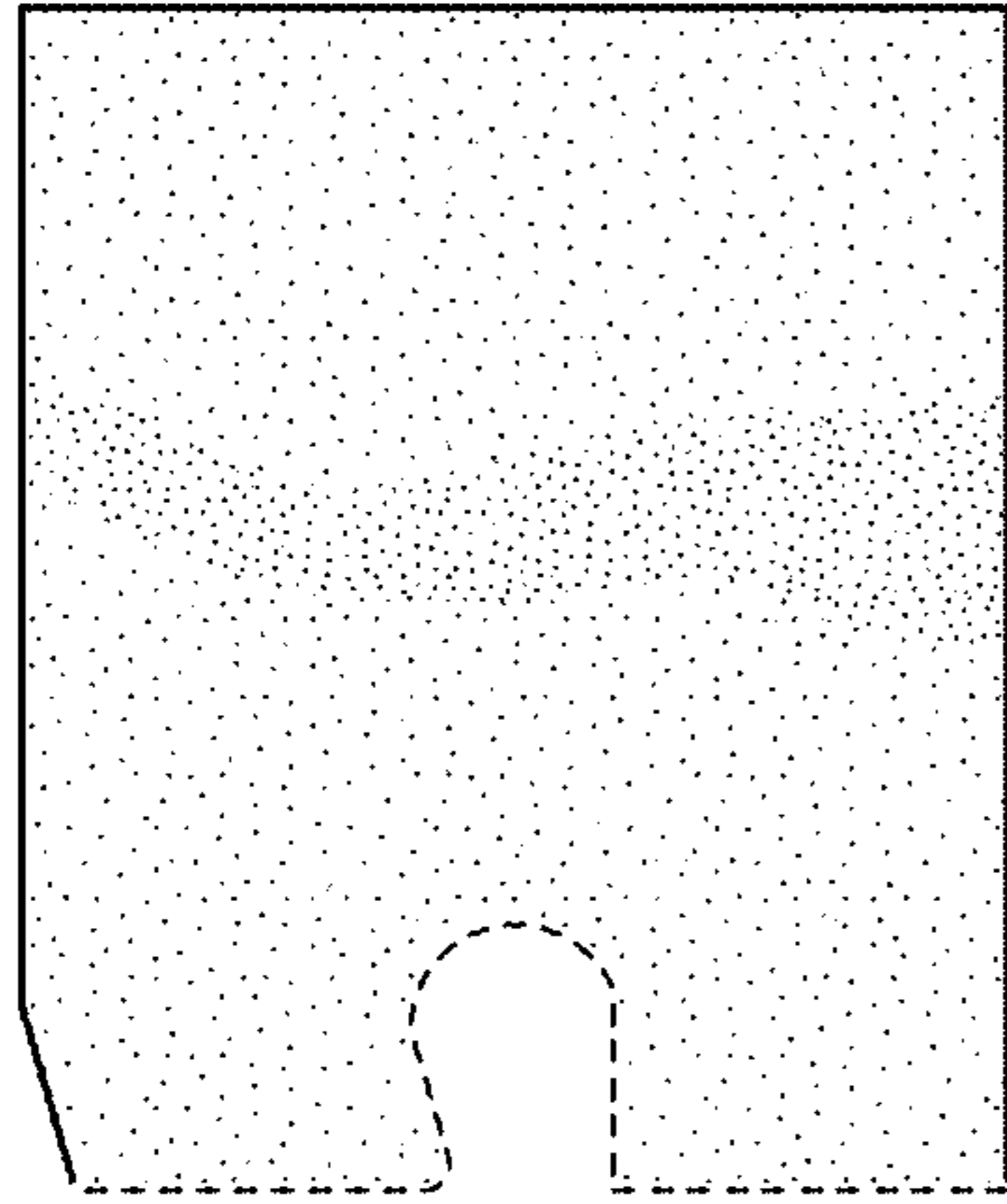

FIG. 14

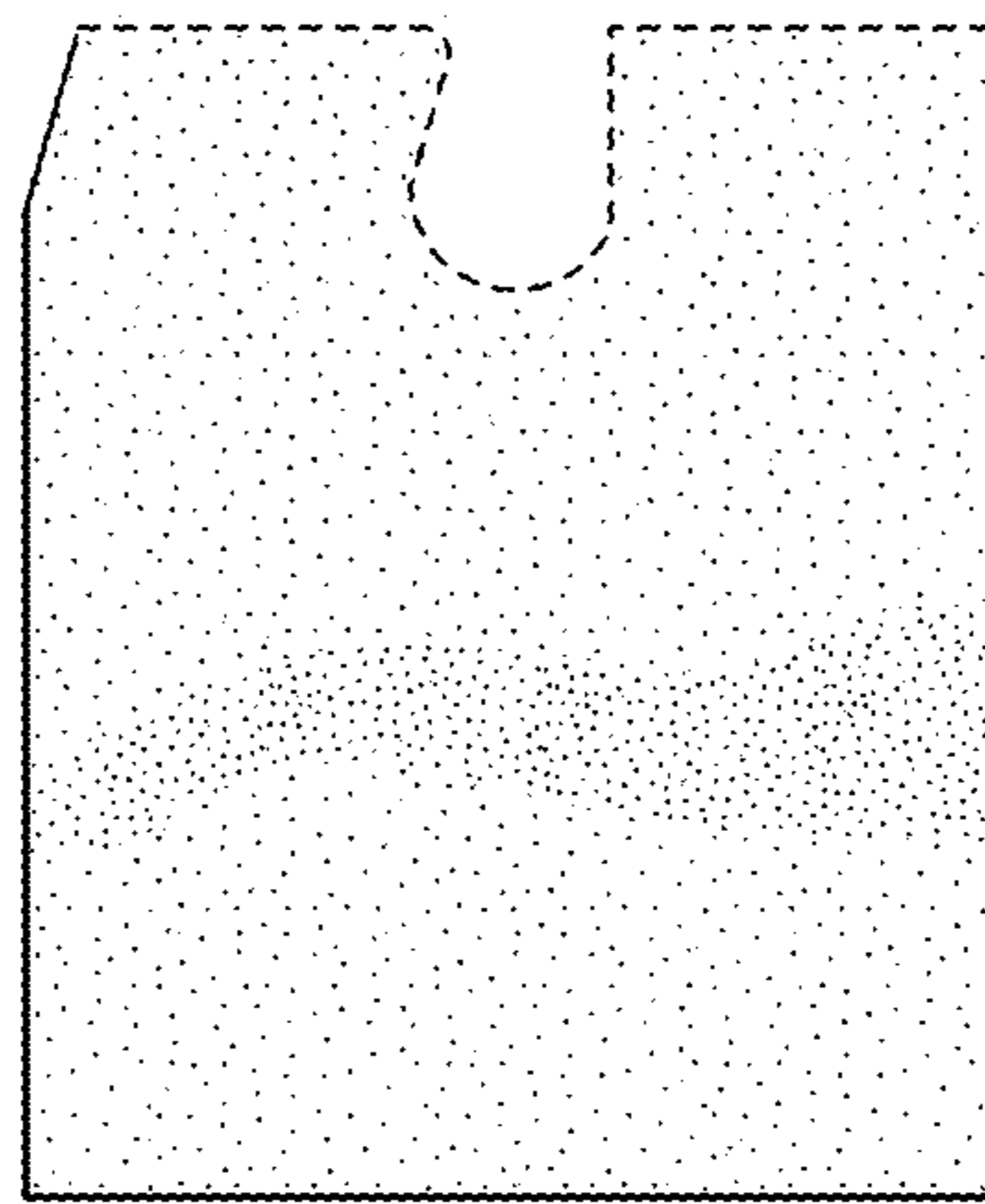
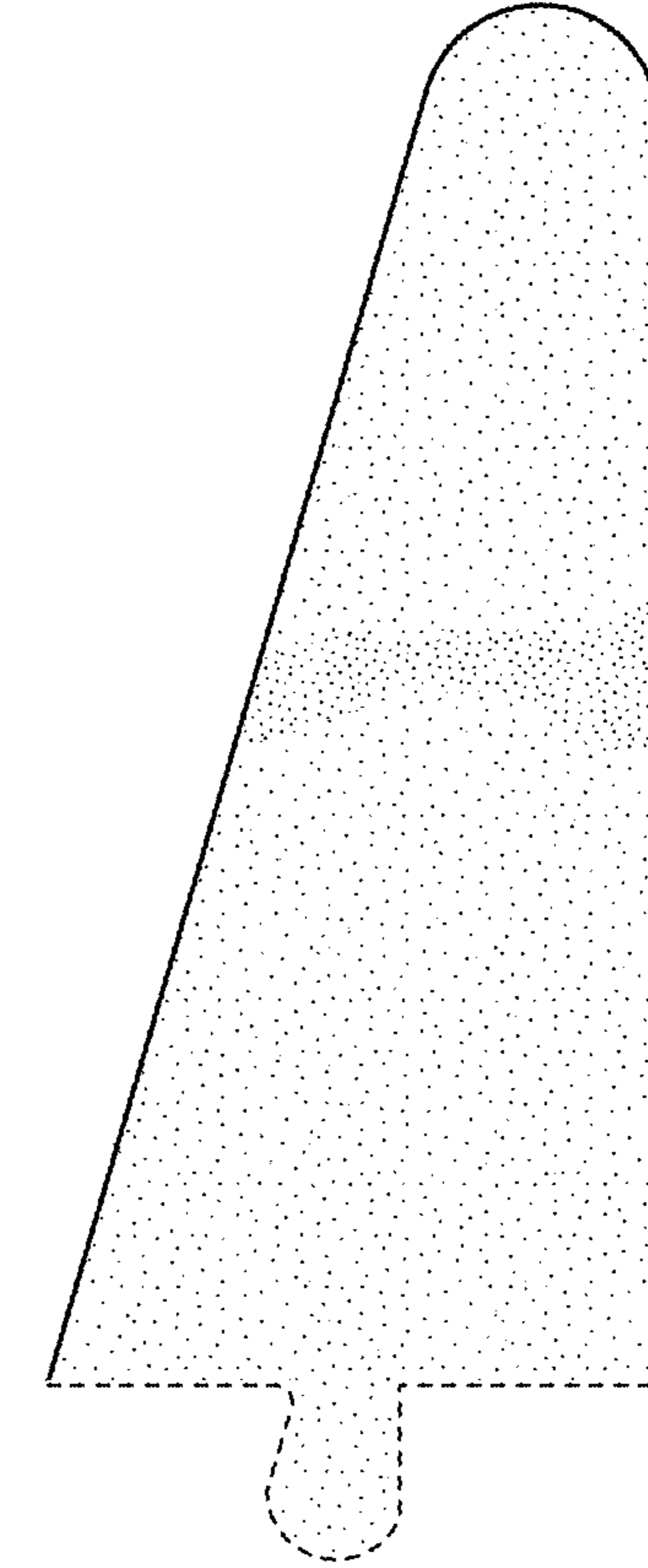

FIG. 15

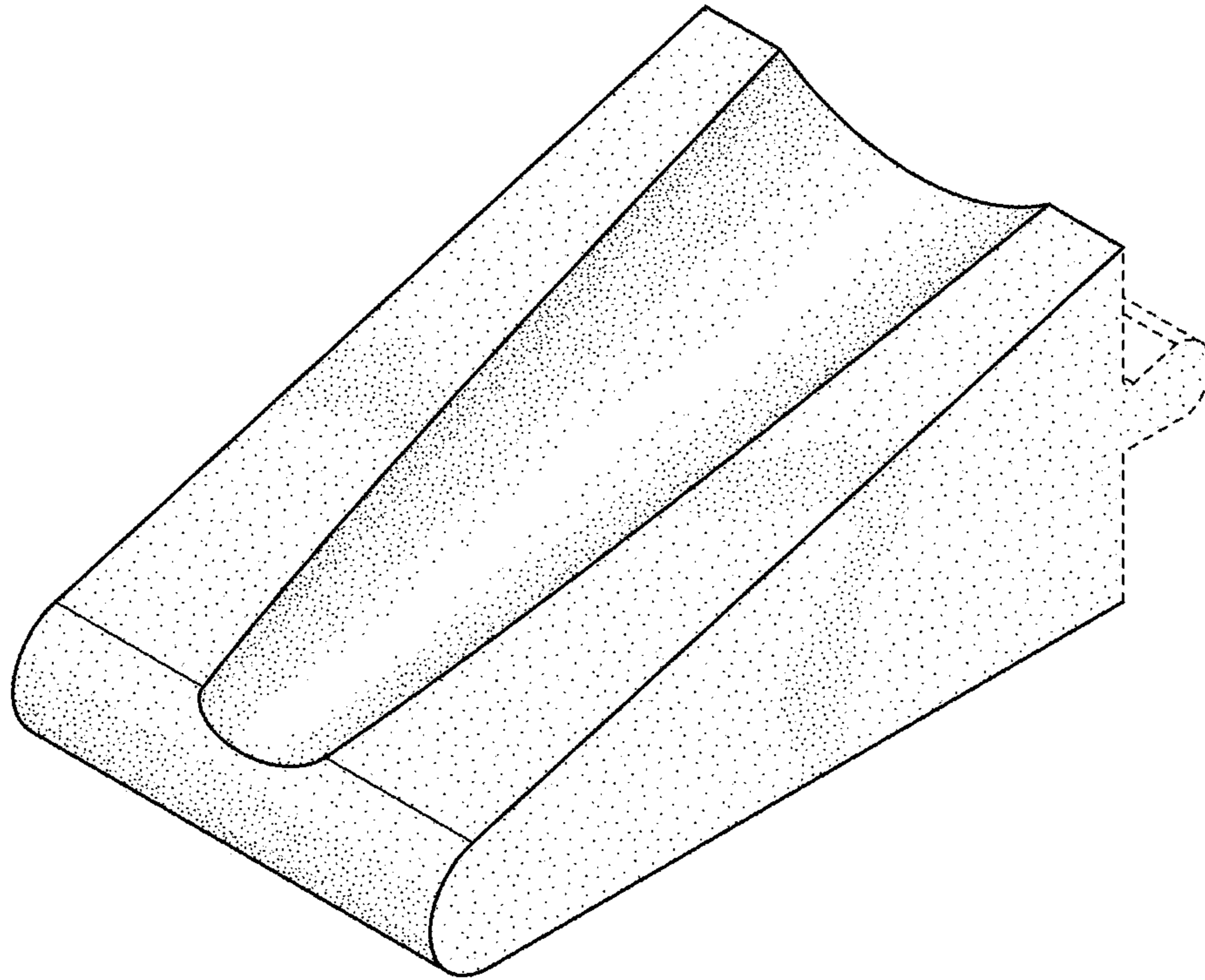

FIG. 16

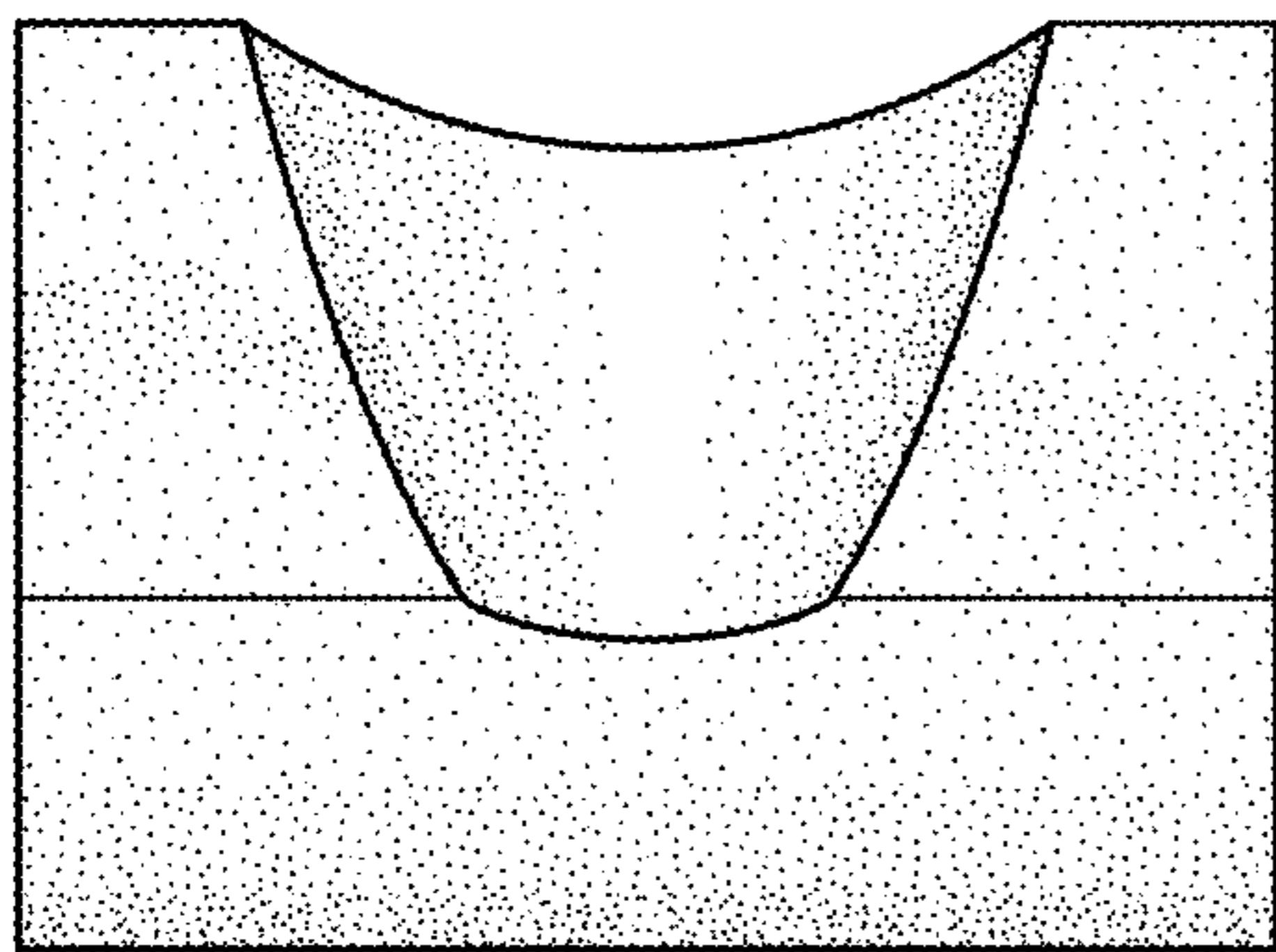

FIG. 17

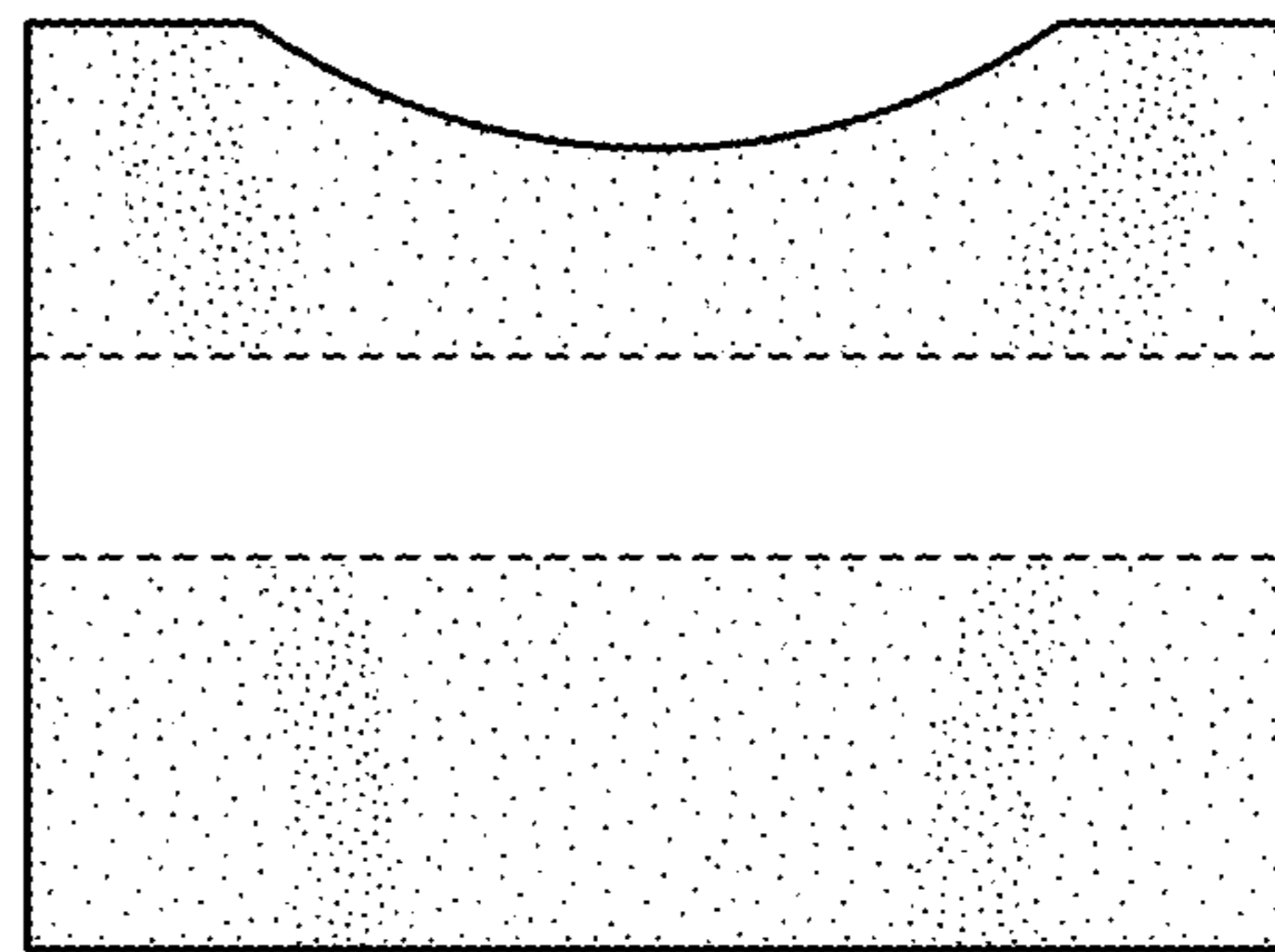

FIG. 18

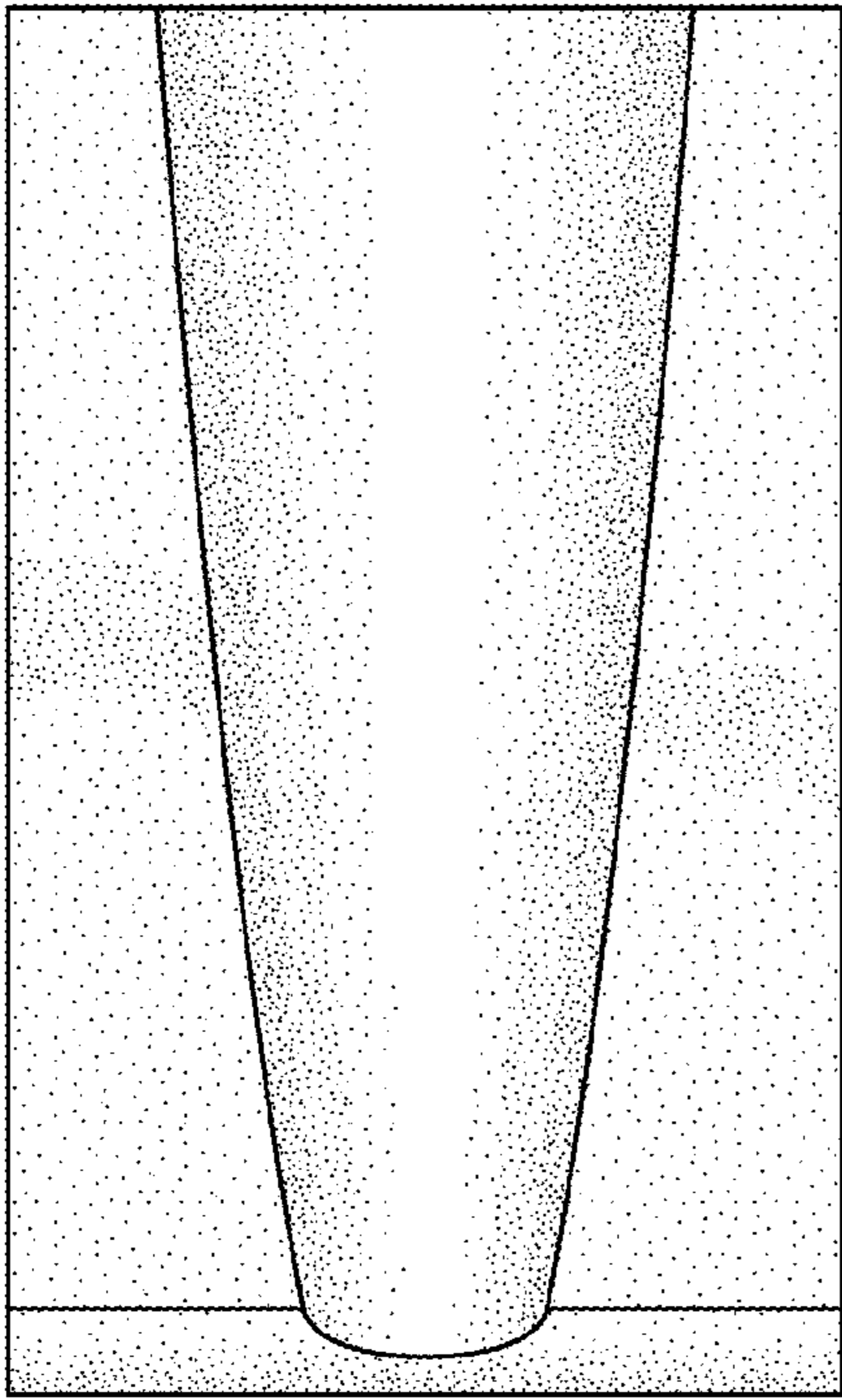

FIG. 19

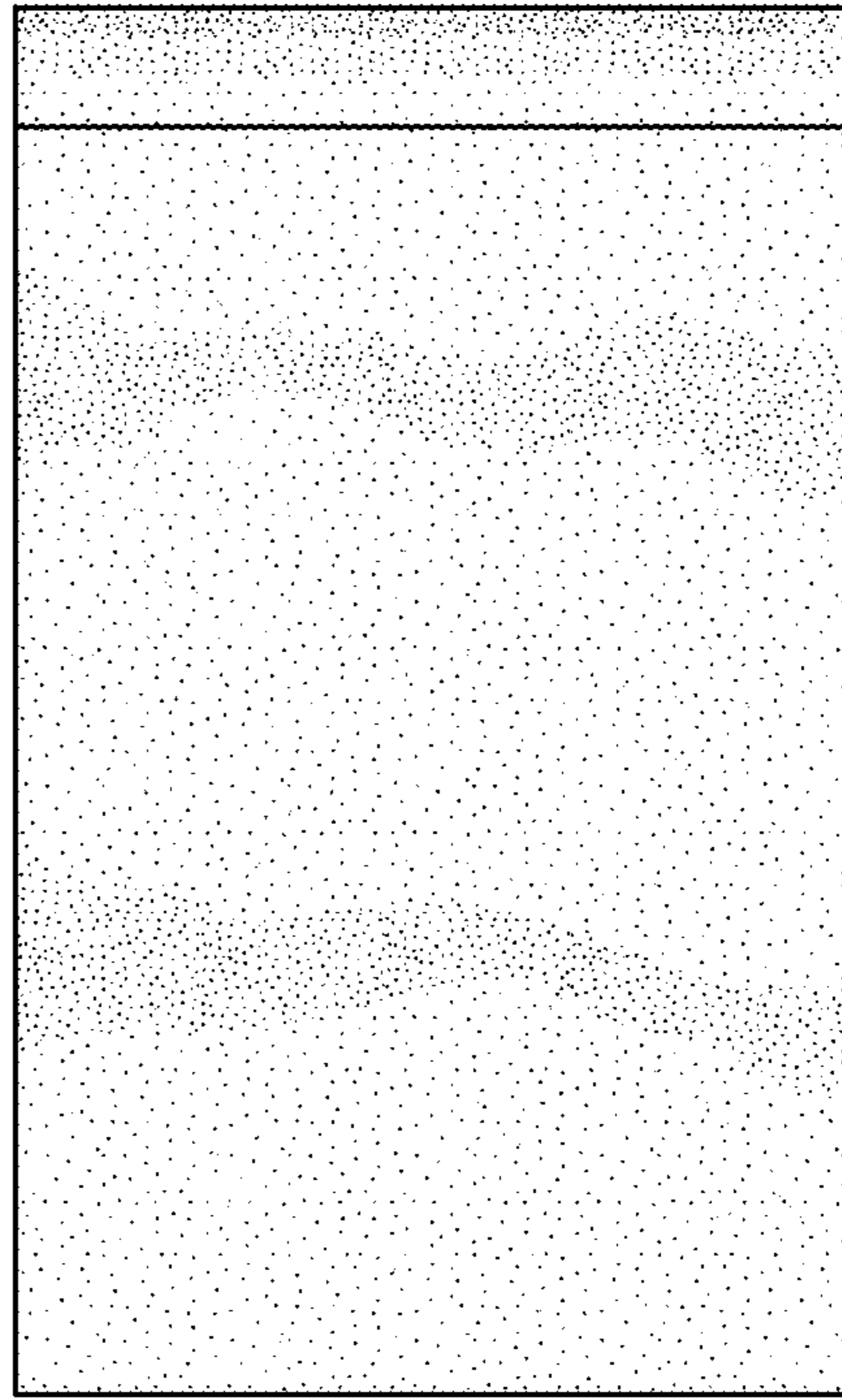

FIG. 20

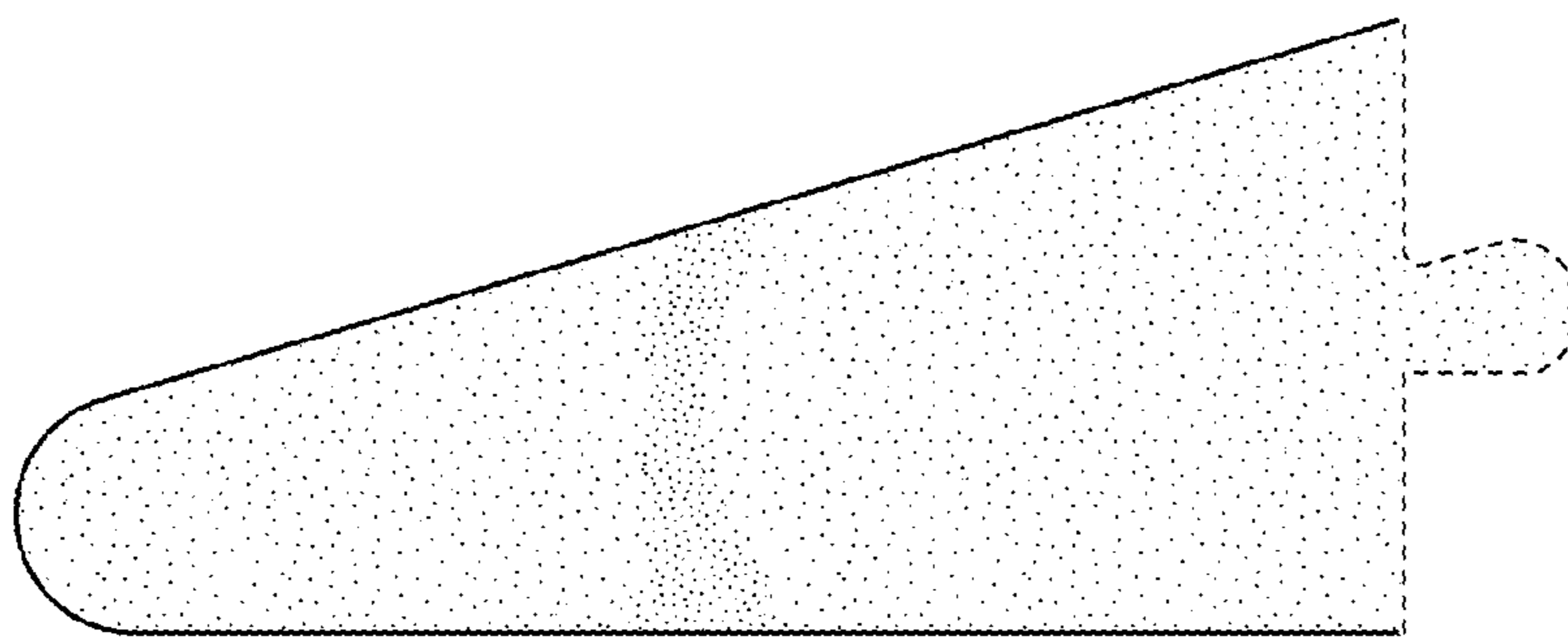

FIG. 21

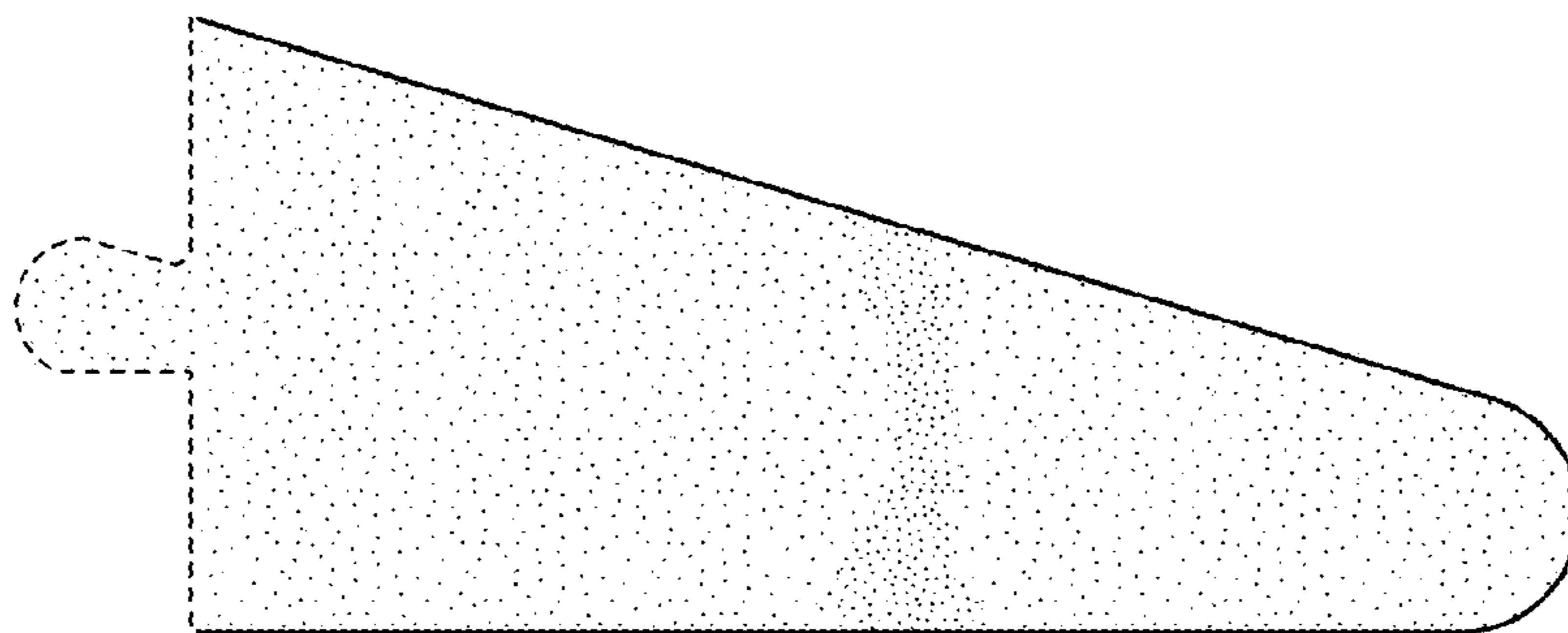

FIG. 22

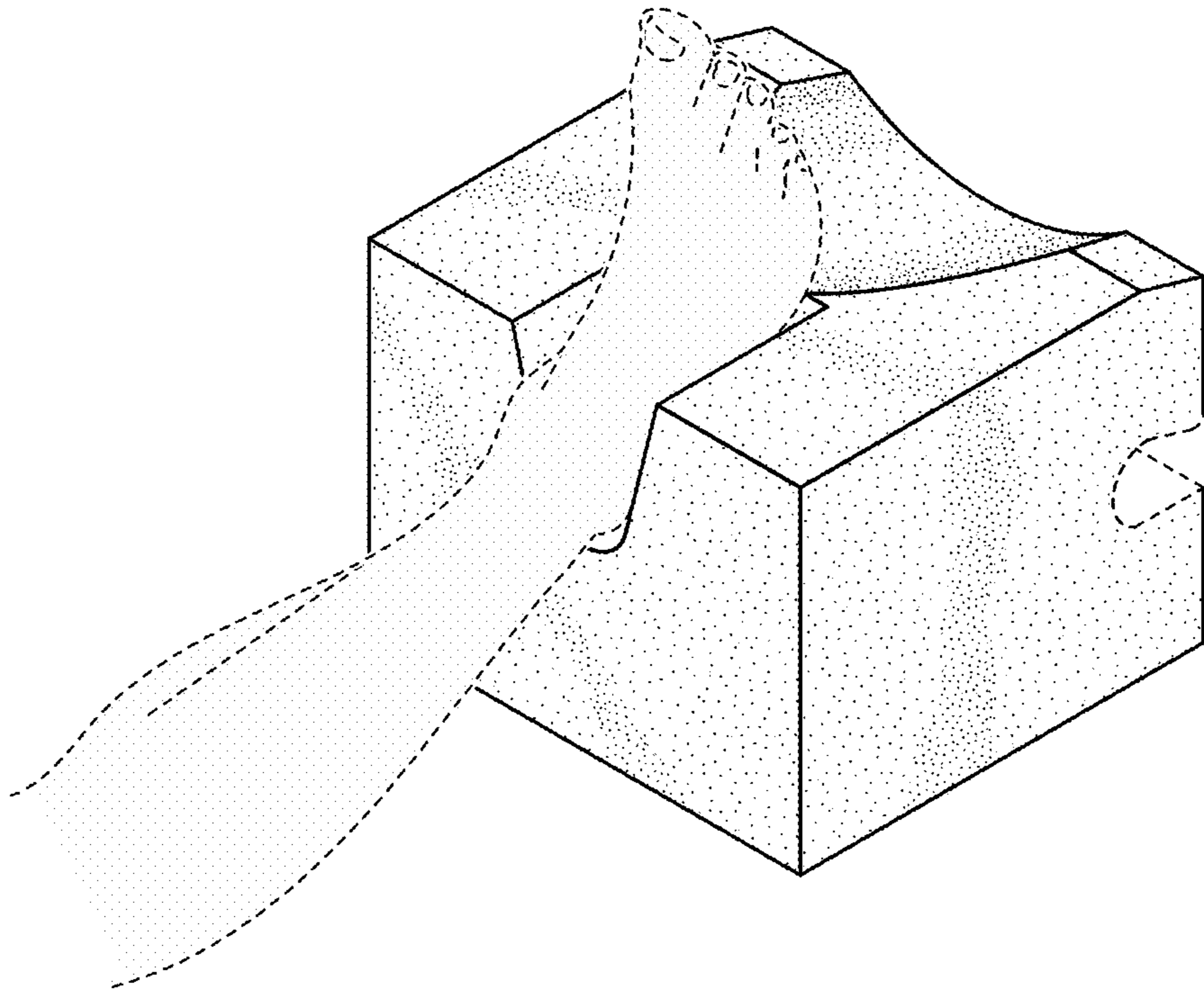

FIG. 23

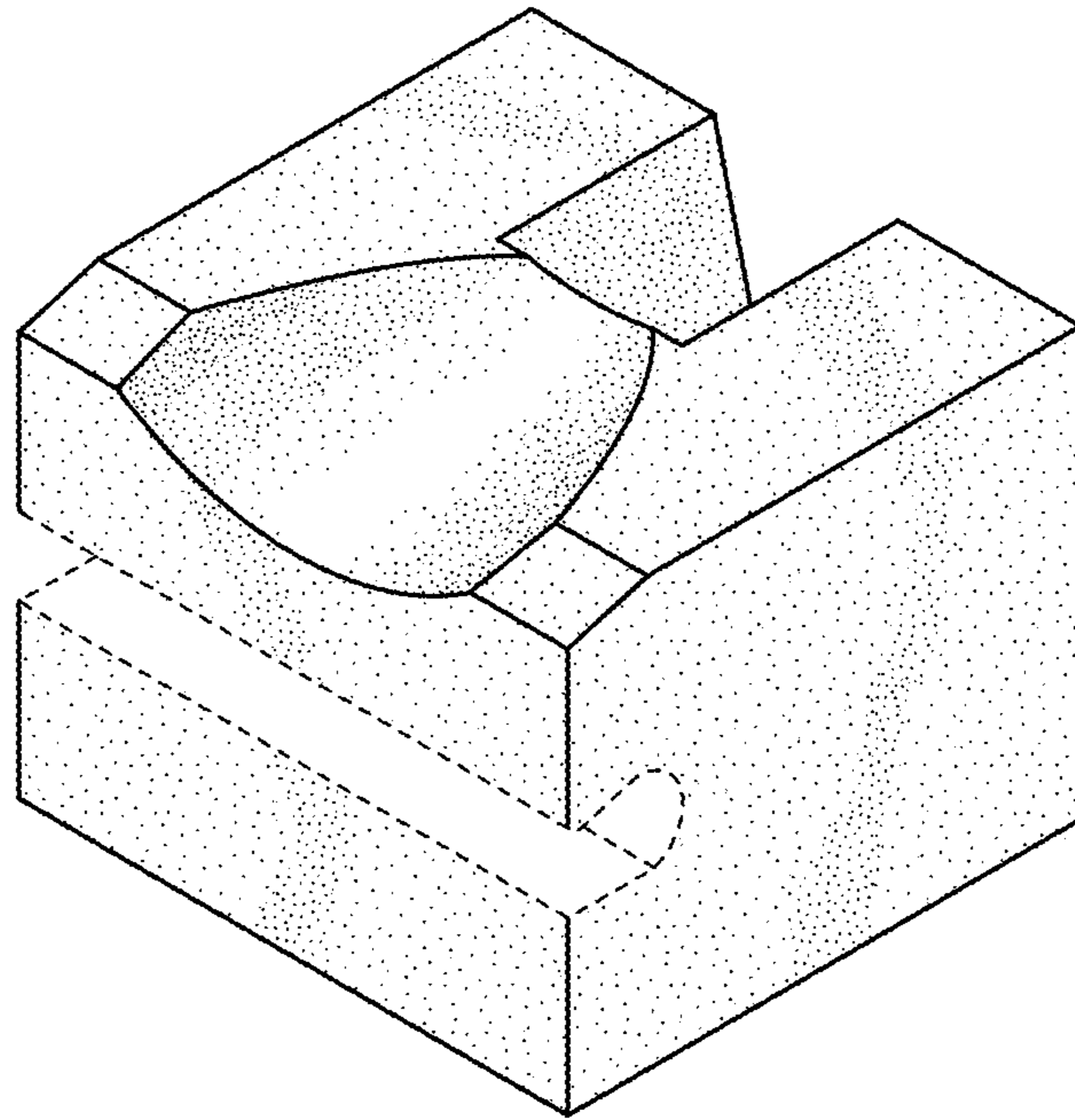

FIG. 24

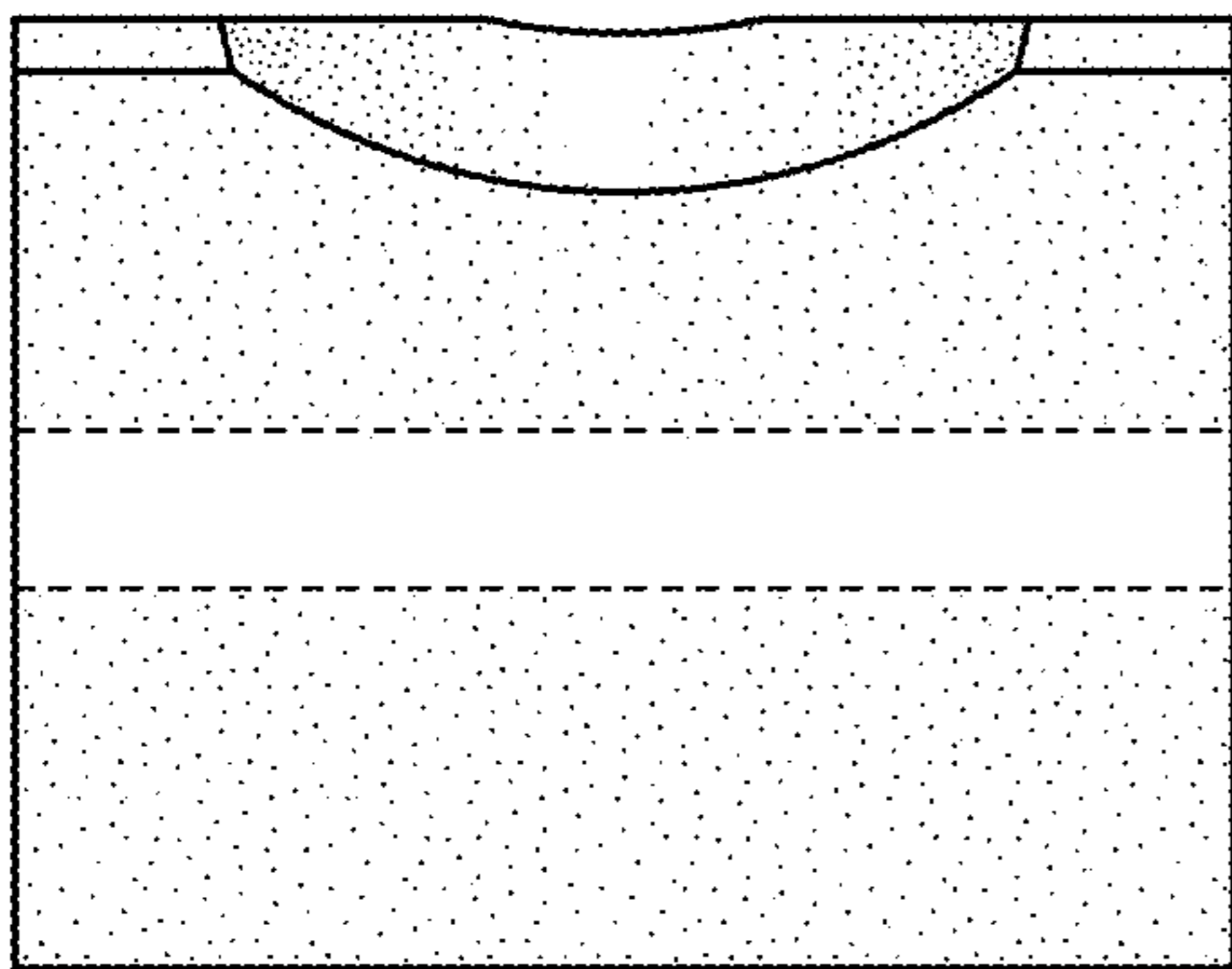

FIG. 25

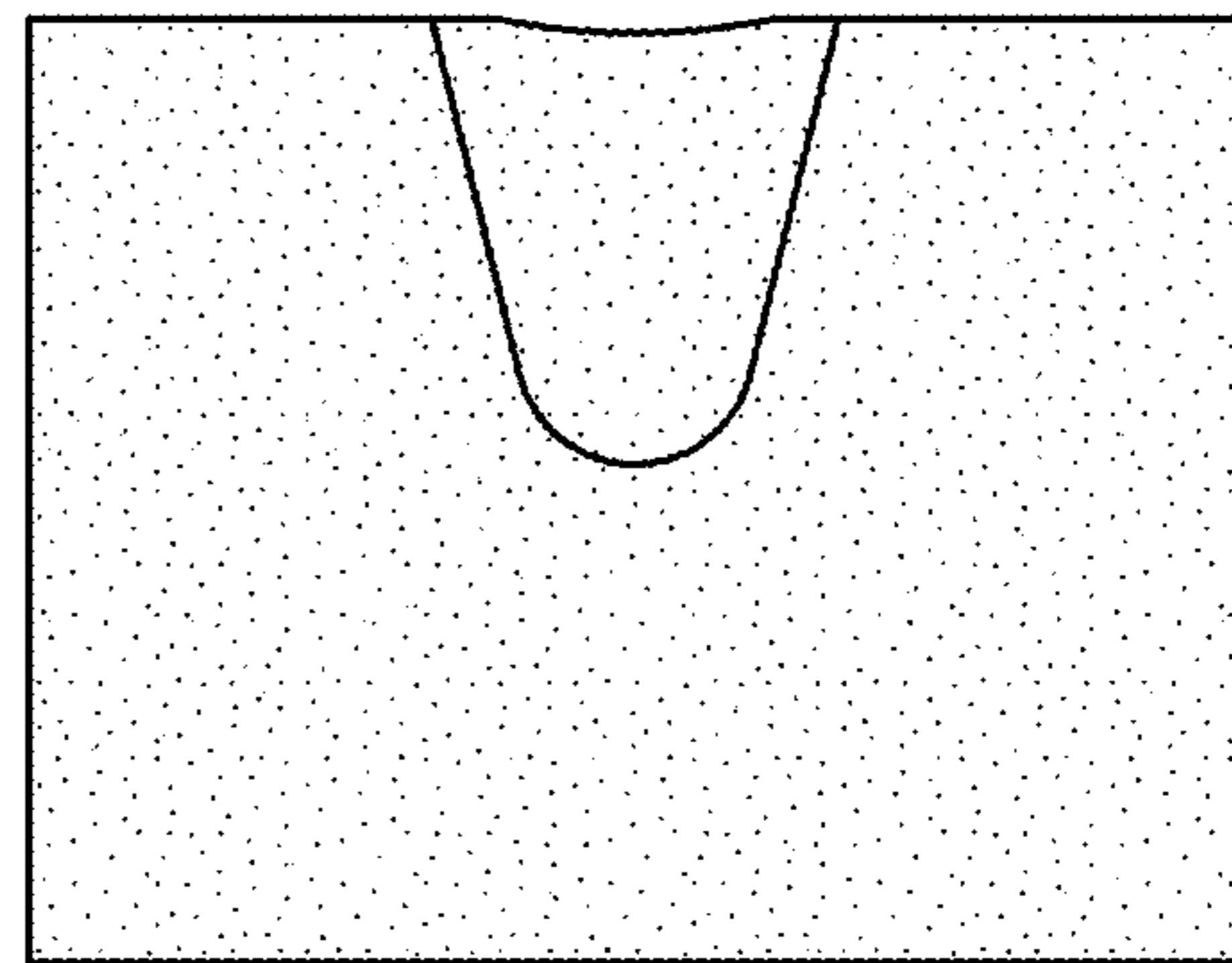

FIG. 26

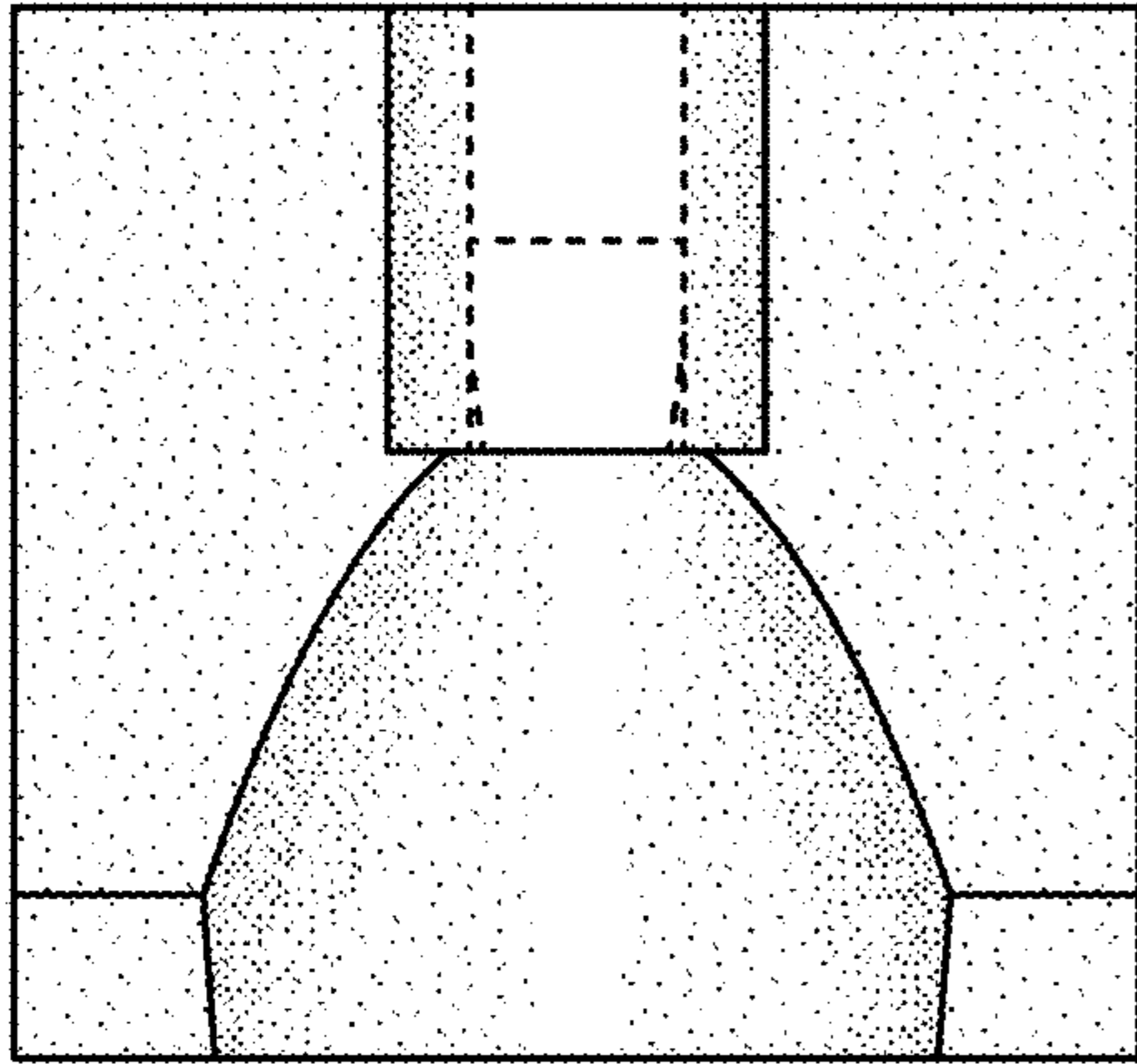

FIG. 27

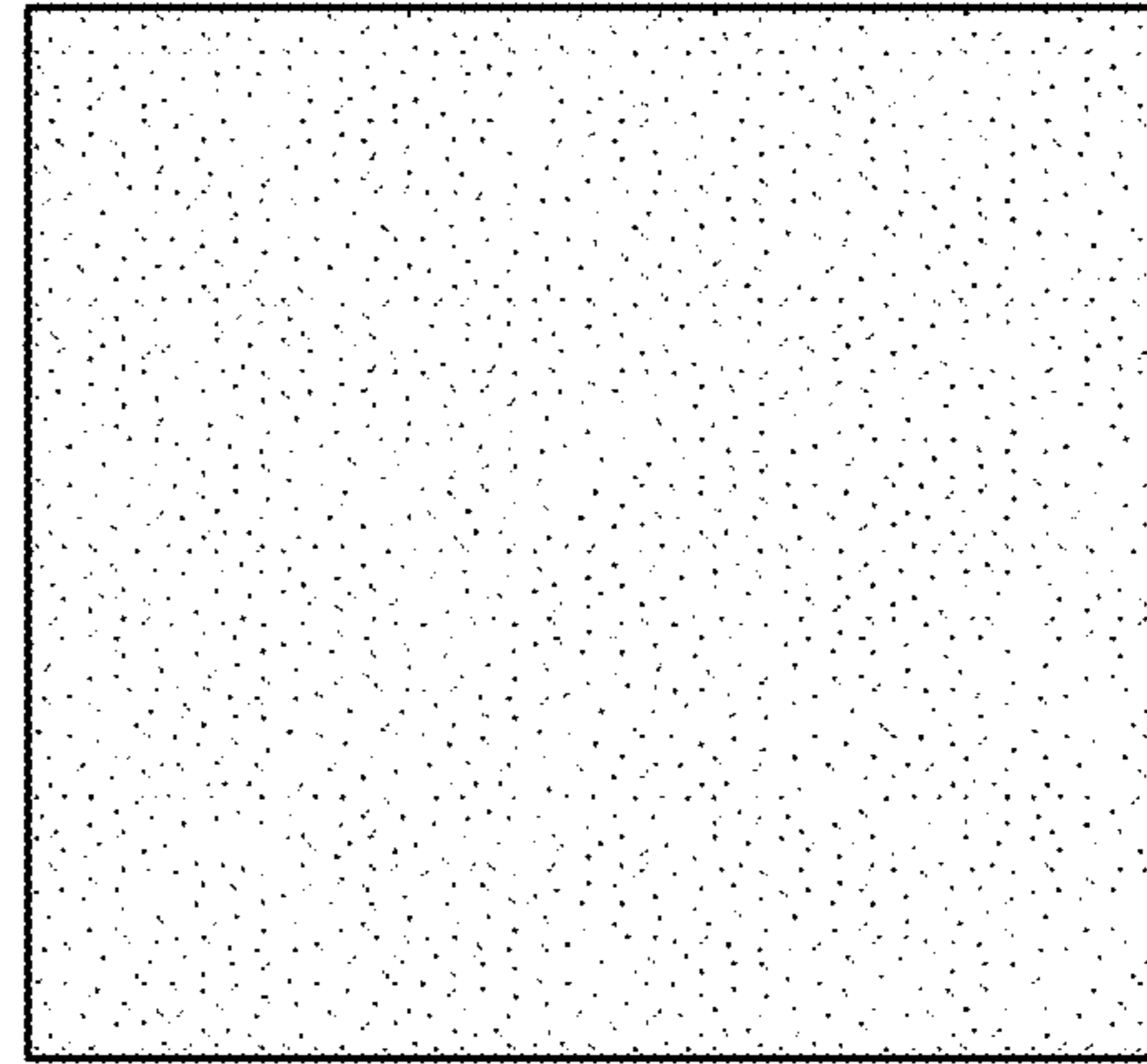

FIG. 28

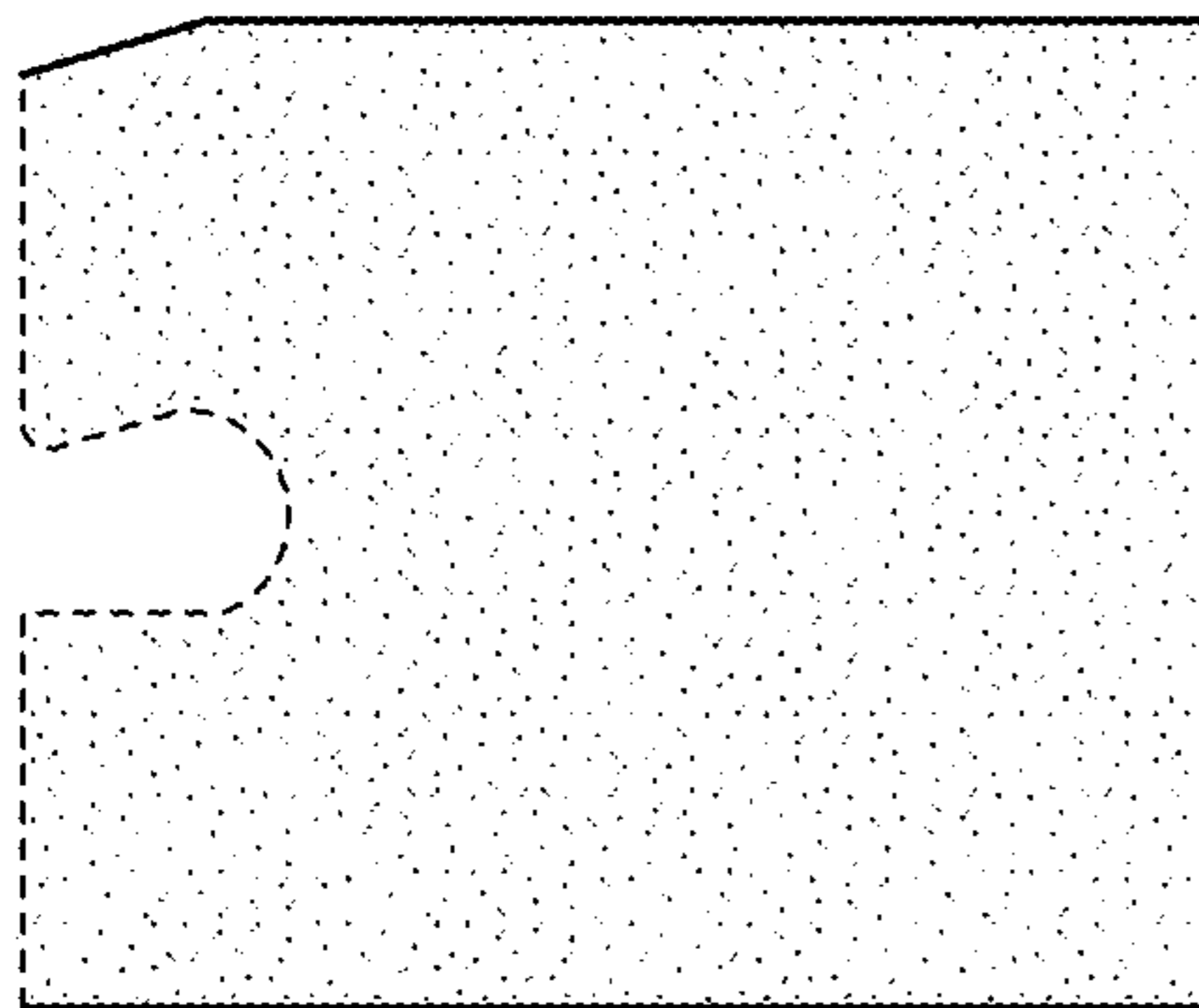

FIG. 29

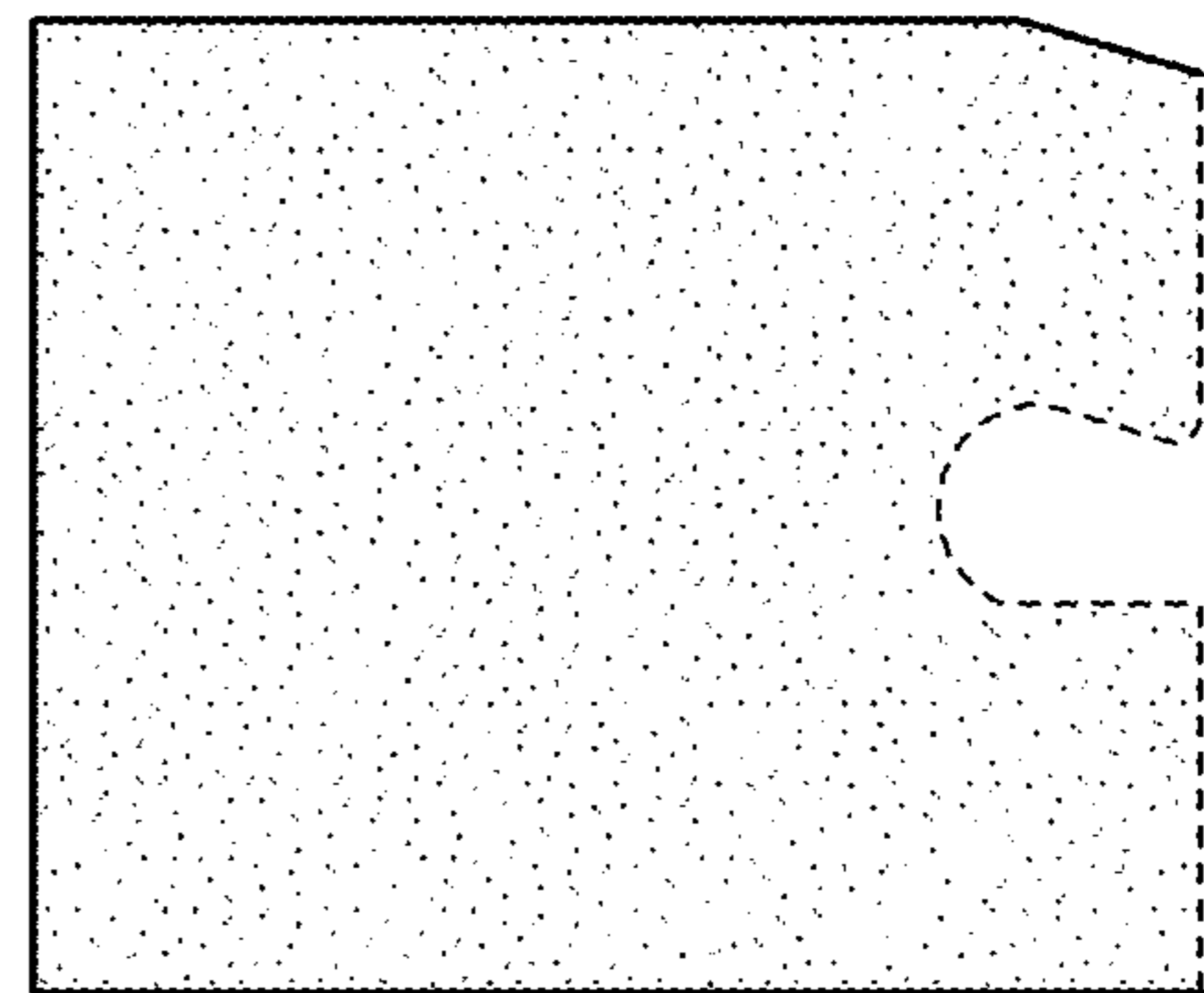

FIG. 30