



US00D968346S

(12) **United States Design Patent** (10) **Patent No.:** **US D968,346 S**
Marten et al. (45) **Date of Patent:** **** *Nov. 1, 2022**

(54) **TELEVISION RECEIVER DEVICE**

(71) Applicant: **DISH Network L.L.C.**, Englewood, CO (US)

(72) Inventors: **Neil T. Marten**, Lakewood, CO (US);
Luke VanDuyn, Conifer, CO (US)

(73) Assignee: **DISH Network L.L.C.**, Englewood, CO (US)

(*) Notice: This patent is subject to a terminal disclaimer.

(**) Term: **15 Years**

(21) Appl. No.: **29/752,053**

(22) Filed: **Sep. 24, 2020**

(51) **LOC (13) Cl.** **14-03**

(52) **U.S. Cl.**
USPC **D14/125**

(58) **Field of Classification Search**
USPC D14/125, 240, 242, 243, 356, 357, 358,
D14/300, 301, 302, 315, 348-355, 363,
D14/365

CPC H04N 21/00; H04N 21/20; H04N 21/40
See application file for complete search history.

(56) **References Cited**

U.S. PATENT DOCUMENTS

D513,617 S *	1/2006	Tierney	D14/496
D522,531 S *	6/2006	Solomon	D14/188
D525,968 S *	8/2006	Peng	D14/300
D532,786 S *	11/2006	Iseki	D14/365
D563,433 S *	3/2008	Yu	D14/496
D640,646 S *	6/2011	Wu	D14/125
D641,327 S *	7/2011	Falakfarsa	D14/125
D661,249 S *	6/2012	Smith	D13/110
D678,258 S *	3/2013	Seto	D14/240
D684,129 S *	6/2013	Vincent	D13/184
D684,957 S *	6/2013	Smith	D14/242
D693,798 S *	11/2013	Chuang	D14/240

D706,263 S *	6/2014	Lin	D14/348
D718,752 S *	12/2014	Wang	D14/240
D722,985 S *	2/2015	Won	D14/125
D725,614 S *	3/2015	Kuh	D14/125
D727,274 S *	4/2015	Park	D14/125
D729,183 S *	5/2015	Zou	D14/125
D730,306 S *	5/2015	Tang	D14/125
D730,850 S *	6/2015	Tang	D14/125

(Continued)

OTHER PUBLICATIONS

Set-top boxes. (Design—© Questel) orbit.com. [online PDF of Foreign references selected by Examiner] 20 pgs. Print Dates Range Dec. 26, 2017 through Jun. 23, 2020 [Retrieved Mar. 21, 2022] <https://www.orbit.com/export/QPTUJ214/pdf2/cb0726c2-c2c1-42ca-9f60-c885b1d9c14d-235859.pdf>.*

(Continued)

Primary Examiner — Marie D. Fast Horse

(74) *Attorney, Agent, or Firm* — Kilpatrick Townsend & Stockton, LLP

(57) **CLAIM**

The ornamental design for a television receiver device, as shown and described.

DESCRIPTION

FIG. 1 is a front top perspective view of a television receiver device, showing our new design;
FIG. 2 is a rear top perspective view thereof;
FIG. 3 is a front elevation view thereof;
FIG. 4 is a rear elevation view thereof;
FIG. 5 is a left elevation view thereof;
FIG. 6 is a right elevation view thereof;
FIG. 7 is a top plan view thereof; and,
FIG. 8 is a bottom plan view thereof.

The broken line showing of the television receiver device is for the purpose of illustrating portions of the television receiver device and forms no part of the claimed design.

1 Claim, 8 Drawing Sheets

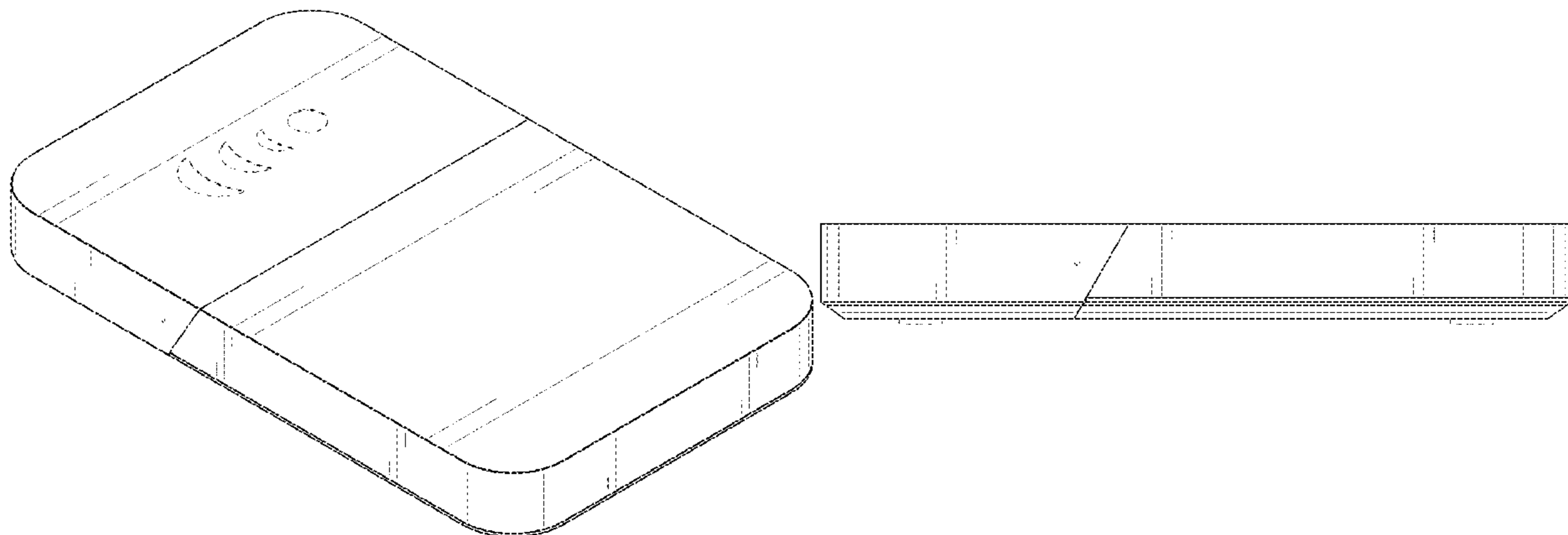

(56)

References Cited

U.S. PATENT DOCUMENTS

D732,010 S * 6/2015 Hsiau D14/240
 D733,080 S * 6/2015 Kuh D14/125
 D738,755 S * 9/2015 Druce D10/50
 D754,627 S * 4/2016 Fustino D14/188
 D777,126 S * 1/2017 Odryna D14/125
 D777,695 S * 1/2017 Odryna D14/125
 D777,696 S * 1/2017 Nichols D14/125
 D781,796 S * 3/2017 Sibley D14/125
 D782,476 S * 3/2017 Yamazaki D14/240
 D785,579 S * 5/2017 McMiller D14/125
 D785,632 S * 5/2017 VanDuyn D14/433
 D789,358 S * 6/2017 Yang D14/496
 D792,409 S * 7/2017 Shim D14/435
 D808,972 S * 1/2018 Magi D14/341
 D814,434 S * 4/2018 Li D14/125
 D815,054 S * 4/2018 Odryna D14/125
 D815,077 S * 4/2018 Sibley D14/242
 D816,624 S * 5/2018 Odryna D14/125
 D827,671 S * 9/2018 Nam D14/203.3
 D828,817 S * 9/2018 Odryna D14/125
 D829,719 S * 10/2018 Shim D14/363
 D831,597 S * 10/2018 Lee D14/125

D834,978 S * 12/2018 Kristensson D10/104.1
 D839,225 S * 1/2019 Hammarstedt D14/125
 D842,829 S * 3/2019 Wang D14/125
 D846,515 S * 4/2019 Hammarstedt D14/125
 D855,029 S * 7/2019 Odryna D14/125
 D857,640 S * 8/2019 Odryna D14/125
 D867,368 S * 11/2019 Magi D14/356
 D867,369 S * 11/2019 Magi D14/356
 D890,760 S * 7/2020 Menendez D14/434
 D930,612 S * 9/2021 Nam D14/203.1
 D938,418 S * 12/2021 Zhang D14/348
 D943,562 S * 2/2022 Ruhman D14/240

OTHER PUBLICATIONS

DISH Wally HD Receiver. (online) 4 pgs. Available as early as Apr. 14, 2017. [Retrieved Mar. 21, 2022] <https://www.dishformyrv.com/dish-wally-hd-receiver/?revpage=3#reviews>.
 DISH product page for Joey Family of Whole Home Receivers, accessed on Nov. 2, 2020, 9 pages.
 DISH product page for Hopper Duo Smart DVR, accessed on Nov. 2, 2020, 7 pages.

* cited by examiner

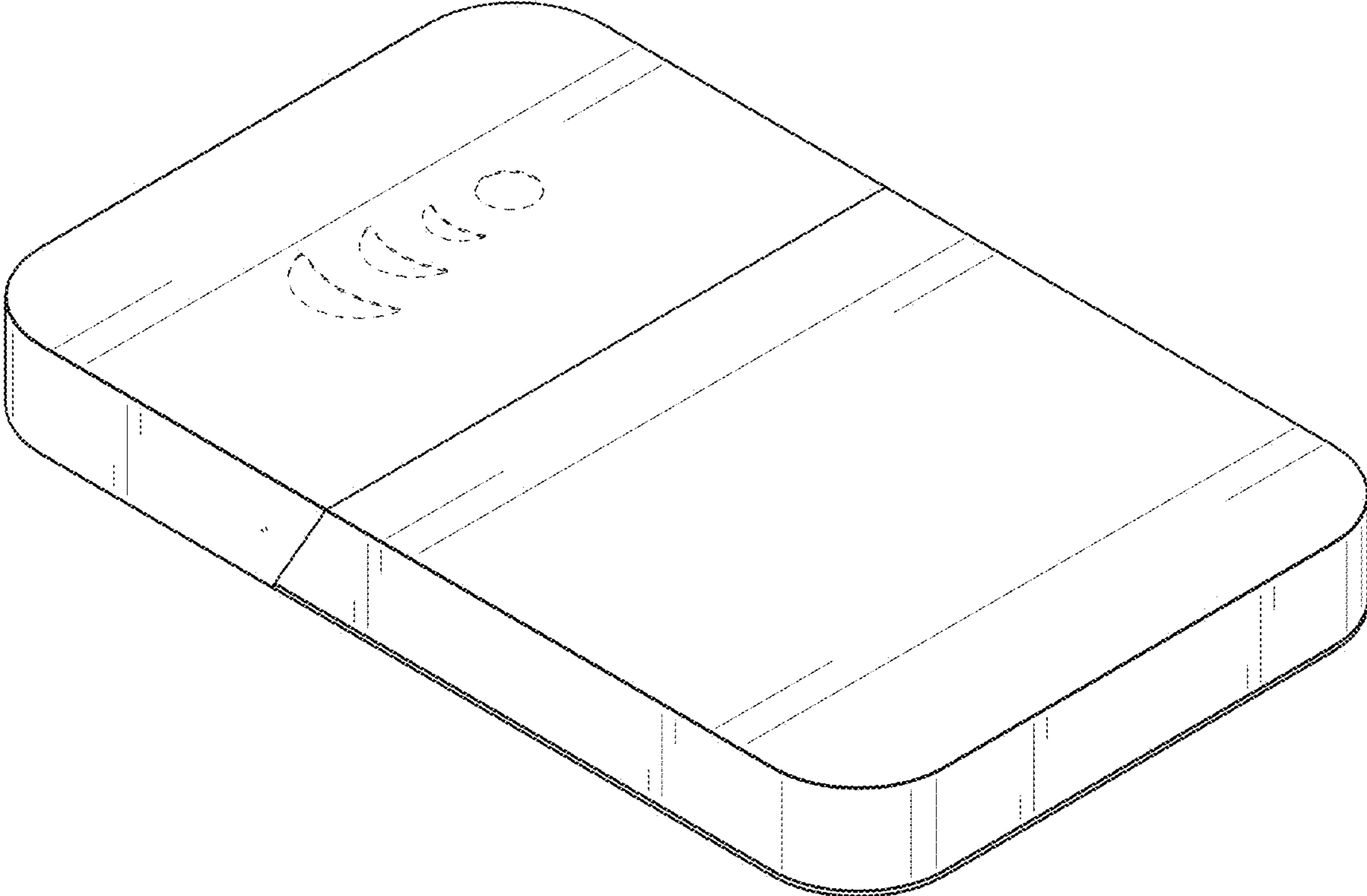

FIG. 1

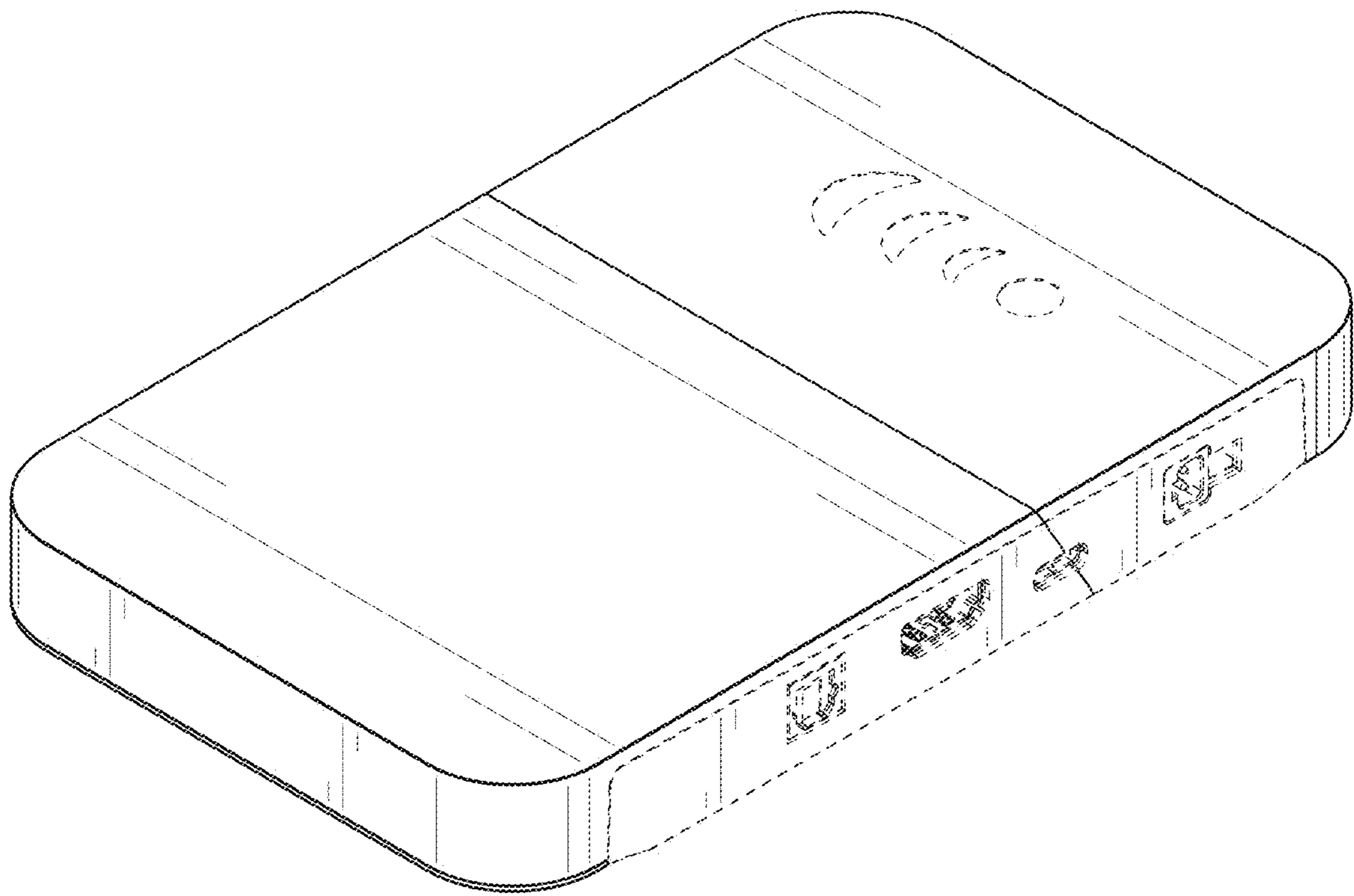

FIG. 2

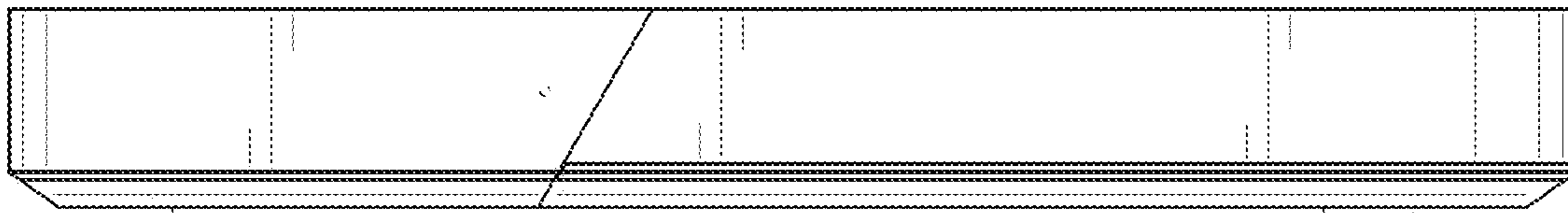

FIG. 3

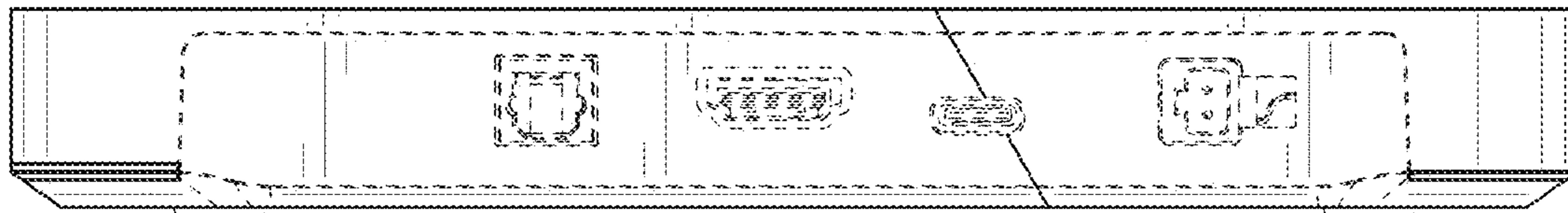

FIG. 4

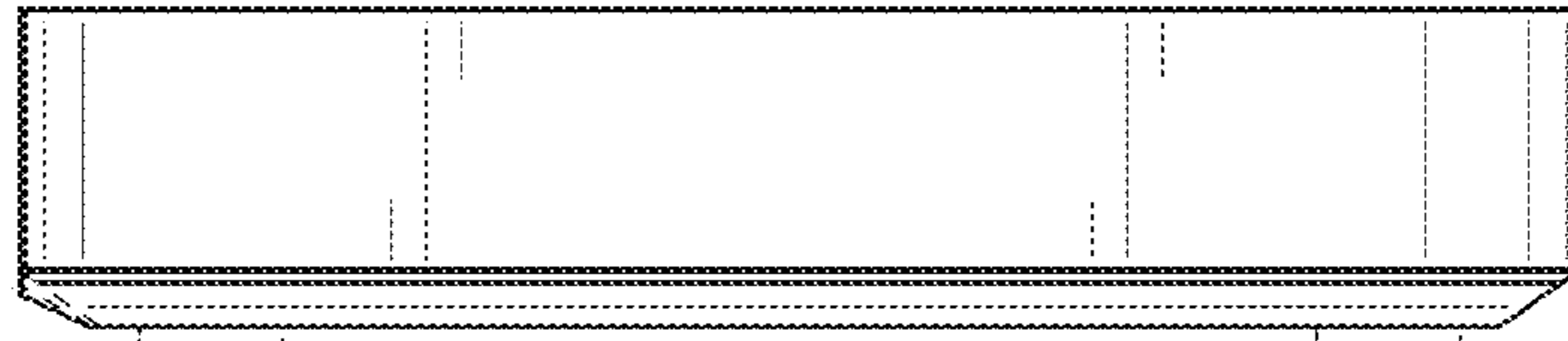

FIG. 5

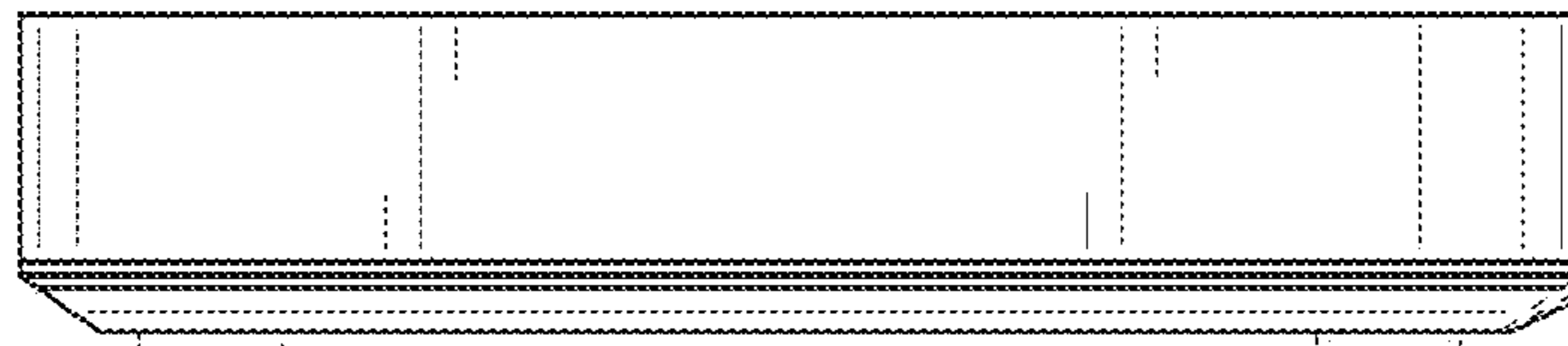

FIG. 6

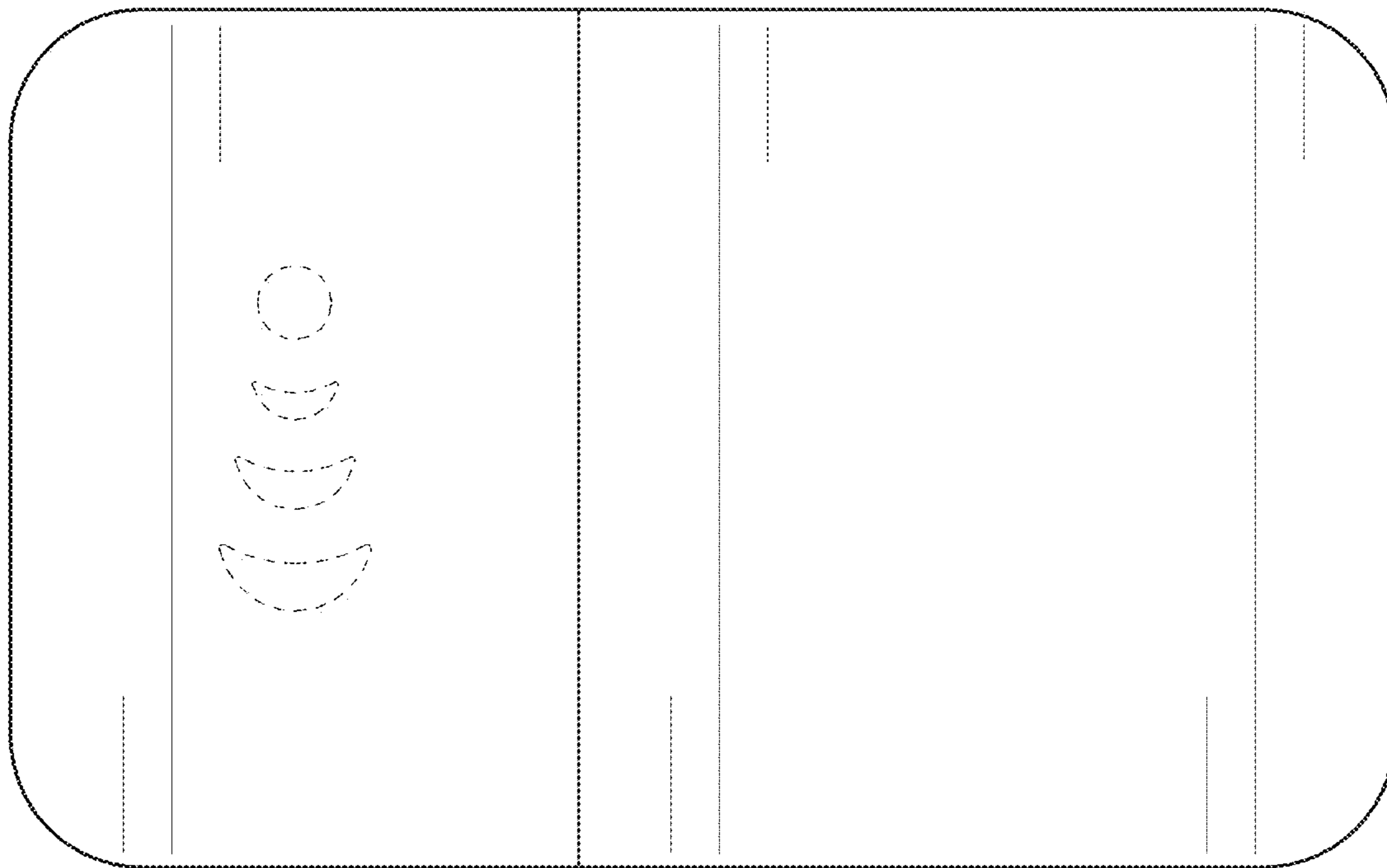

FIG. 7

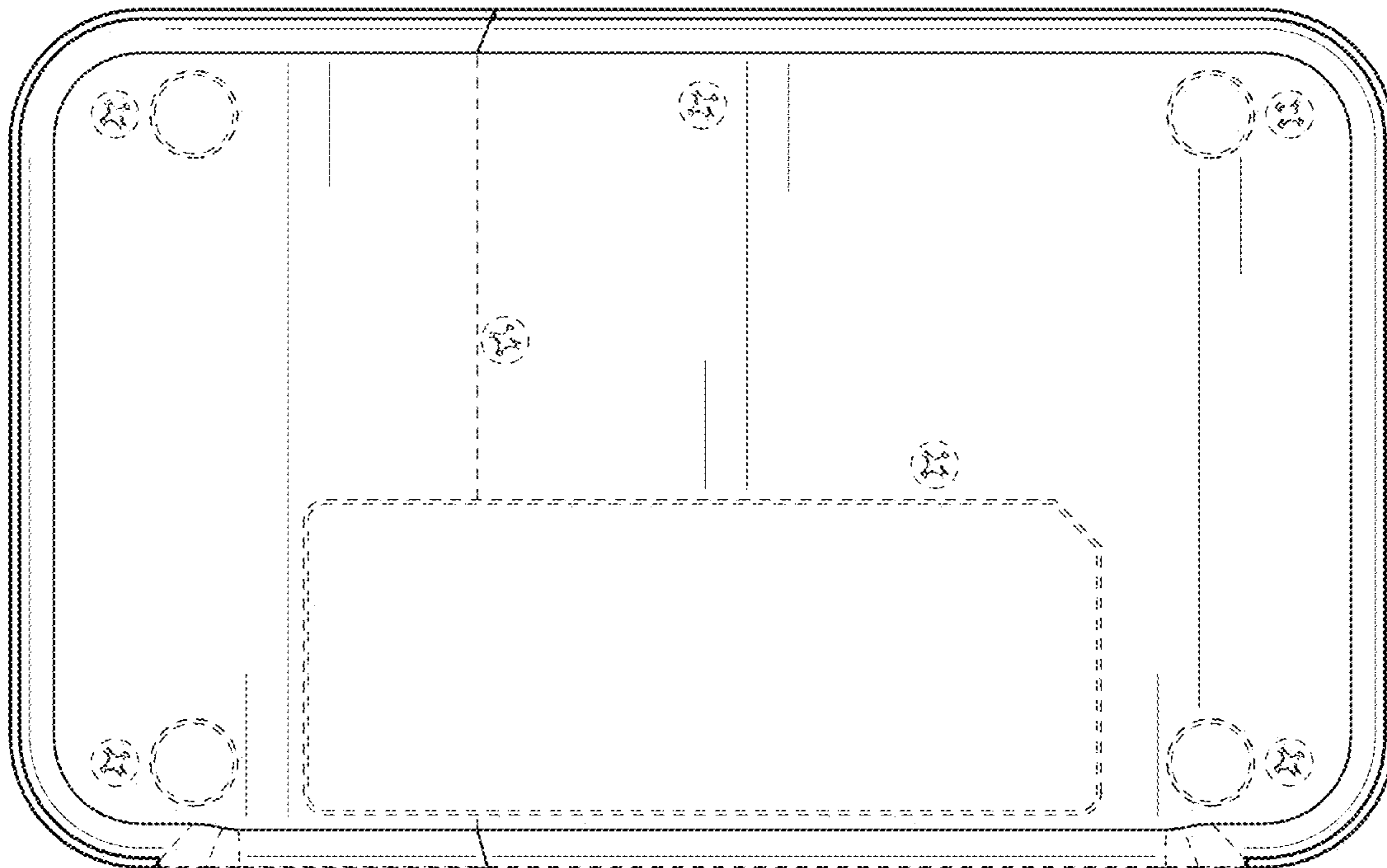

FIG. 8