



US00D968336S

(12) **United States Design Patent** (10) **Patent No.:** **US D968,336 S**
Merkel et al. (45) **Date of Patent:** **** Nov. 1, 2022**

(54) **LOAD CENTER WITH INTEGRATED RECEPTACLES**

(71) Applicant: **CORE SCIENTIFIC, INC.**, Bellevue, WA (US)

(72) Inventors: **Matt Merkel**, Marble, NC (US); **Garry Fife**, Marble, NC (US)

(73) Assignee: **Core Scientific, Inc.**, Bellevue, WA (US)

(**) Term: **15 Years**

(21) Appl. No.: **29/712,517**

(22) Filed: **Nov. 8, 2019**

(51) **LOC (13) Cl.** **13-03**

(52) **U.S. Cl.**

USPC **D13/139.7**

(58) **Field of Classification Search**

USPC D13/133, 137.1, 137.2, 137.3, 137.4, D13/138.1, 138.2, 139.1, 139.2, 139.3,

(Continued)

(56) **References Cited**

U.S. PATENT DOCUMENTS

D270,831 S * 10/1983 Jensen D23/239
D318,854 S * 8/1991 Sharp D13/160

(Continued)

FOREIGN PATENT DOCUMENTS

CA 67066 * 10/1990
SG 20051749E-0001 * 12/2005

OTHER PUBLICATIONS

“3273374”, first accessed Mar. 14, 2022. Mouser.com [https://www.mouser.com/ProductDetail/Phoenix-Contact/3273374?qs=gt1LBUVyoHn5YZGgt%2FS4Pw%3D%3D&mgh=1&gclid=EAIalQobChMII43P3%E2%80%A6] (Year: 2022).*

(Continued)

Primary Examiner — Rosemary K Tarcaza
Assistant Examiner — Seth David Kumpf
(74) *Attorney, Agent, or Firm* — Fishman Stewart PLLC

(57) **CLAIM**

The ornamental design for a load center with integrated receptacles, as shown and described.

DESCRIPTION

FIG. 1 is a top perspective view of a load center with integrated receptacles;
FIG. 2 is an enlarged view of portion 2 shown in FIG. 1;
FIG. 3 is a front view of a load center with integrated receptacles;
FIG. 4 is a back view of a load center with integrated receptacles;
FIG. 5 is a right-side view of a load center with integrated receptacles;
FIG. 6 is an enlarged view of portion 6 shown in FIG. 5;
FIG. 7 is a left-side view of a load center with integrated receptacles;
FIG. 8 is a top view of a load center with integrated receptacles;
FIG. 9 is a bottom view of a load center with integrated receptacles;
FIG. 10 is another top perspective view of a load center with integrated receptacles illustrated in FIG. 1, shown with the door in an open position to display internal components of the load center;
FIG. 11 is another front view of a load center with integrated receptacles illustrated in FIG. 3, shown with the door in an open position to display internal components of the load center;
FIG. 12 is another back view of a load center with integrated receptacles illustrated in FIG. 4, shown with the door in an open position;
FIG. 13 is another right-side view of a load center with integrated receptacles illustrated in FIG. 5, shown with the door in an open position;
FIG. 14 is another left-side view of a load center with integrated receptacles illustrated in FIG. 7, shown with the door in an open position;

(Continued)

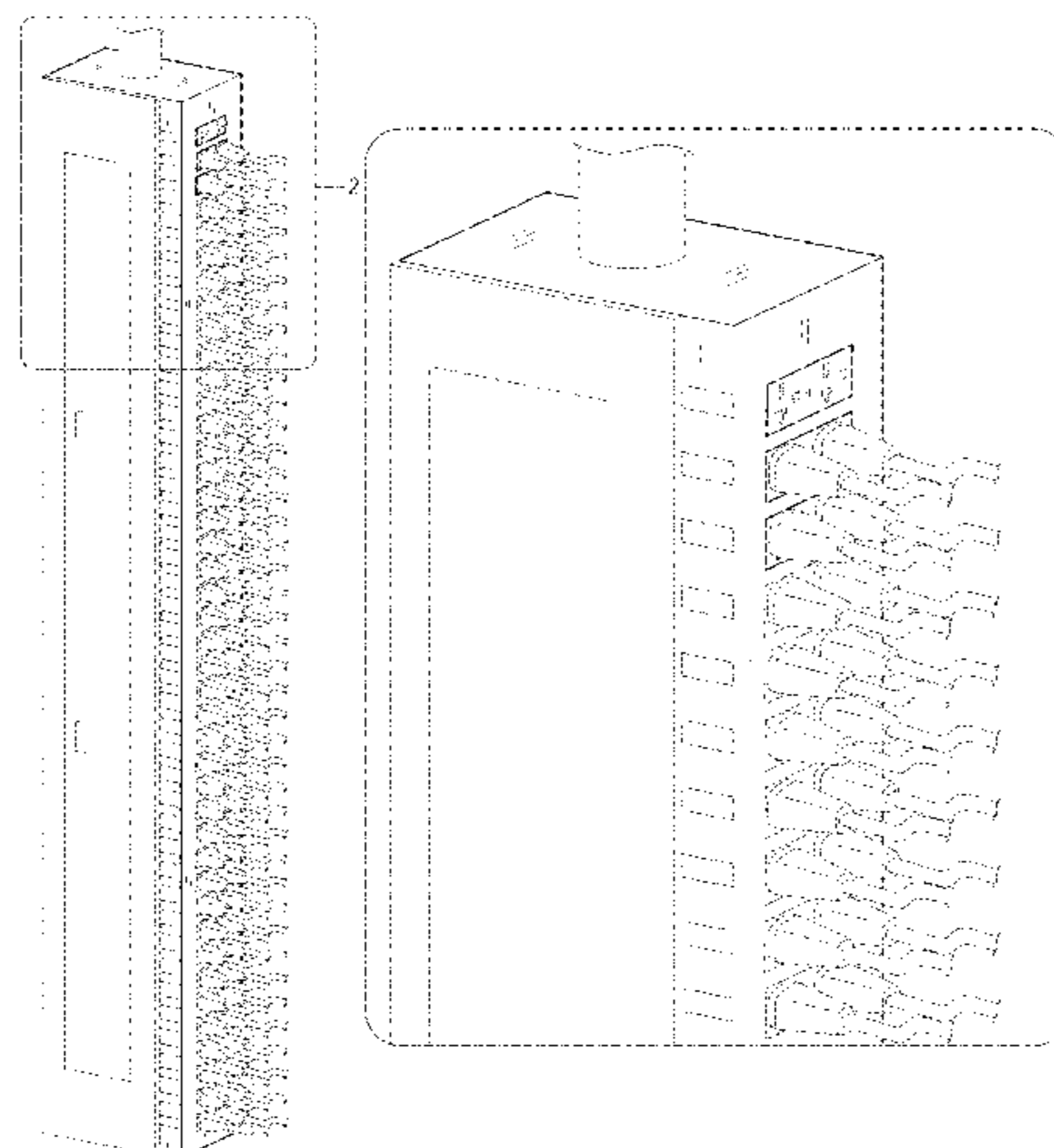

FIG. 15 is another top view of a load center with integrated receptacles illustrated in FIG. 8 shown with the door in an open position; and,

FIG. 16 is another bottom view of a load center with integrated receptacles illustrated in FIG. 9, shown with the door in an open position.

The broken lines in the drawings illustrate portions of the load center with integrated receptacles or environmental structures that form no part of the claimed design.

1 Claim, 13 Drawing Sheets

(58) **Field of Classification Search**

USPC D13/139.4, 139.5, 139.6, 139.7, 139.8,
D13/146, 147, 152, 160, 184, 199
CPC H02J 3/00; H02J 3/005; H02J 3/007; H02J
3/06; H02J 9/04; H02J 9/062; H02B 1/00;
H02B 1/26; H02B 1/46

See application file for complete search history.

(56) **References Cited**

U.S. PATENT DOCUMENTS

5,072,071 A * 12/1991 Cassity H02G 3/14
174/59
5,081,560 A * 1/1992 Donnerstag H02B 1/056
361/627
5,134,543 A * 7/1992 Sharp H02B 1/056
361/644

D329,638 S * 9/1992 Sharp D13/173
D332,603 S * 1/1993 Rumbles D13/184
D390,826 S * 2/1998 Bates D13/184
D434,001 S * 11/2000 Sayger D13/139.5
D436,921 S * 1/2001 McCoy D13/139.1
D448,346 S * 9/2001 Hellwig D25/132
6,937,461 B1 8/2005 Donahue, IV
7,271,506 B1 9/2007 Bersiek
D558,676 S * 1/2008 Fort D13/139.3
7,646,590 B1 1/2010 Corhodzic et al.
D669,856 S * 10/2012 Rosendahl D13/139.5
9,141,154 B2 9/2015 Champion et al.
D754,074 S * 4/2016 DeCosta D13/139.3
D755,128 S * 5/2016 Page D13/139.4
D830,975 S * 10/2018 Vierjärvi D13/163
D831,587 S * 10/2018 Vierjärvi D13/163
D833,404 S * 11/2018 Vierjärvi D13/163
D833,983 S * 11/2018 Vierjärvi D13/163
D833,984 S * 11/2018 Vierjärvi D13/163
D833,985 S * 11/2018 Vierjärvi D13/163
D886,752 S * 6/2020 Xiang D13/133
D896,191 S * 9/2020 Xiang D13/133
D937,235 S * 11/2021 Xiang D13/133
2009/0031148 A1 1/2009 Densham

OTHER PUBLICATIONS

“BR Loadcenters”, first accessed Mar. 10, 2022. Easton.com [https://www.eaton.com/us/en-us/catalog/low-voltage-power-distribution-controls-systems/br-load-centers.html] (Year: 2022).*
“CH Loadcenters”, first accessed Mar. 10, 2022. Easton.com [https://www.eaton.com/us/en-us/catalog/low-voltage-power-distribution-controls-systems/ch-load-centers.html] (Year: 2022).*

* cited by examiner

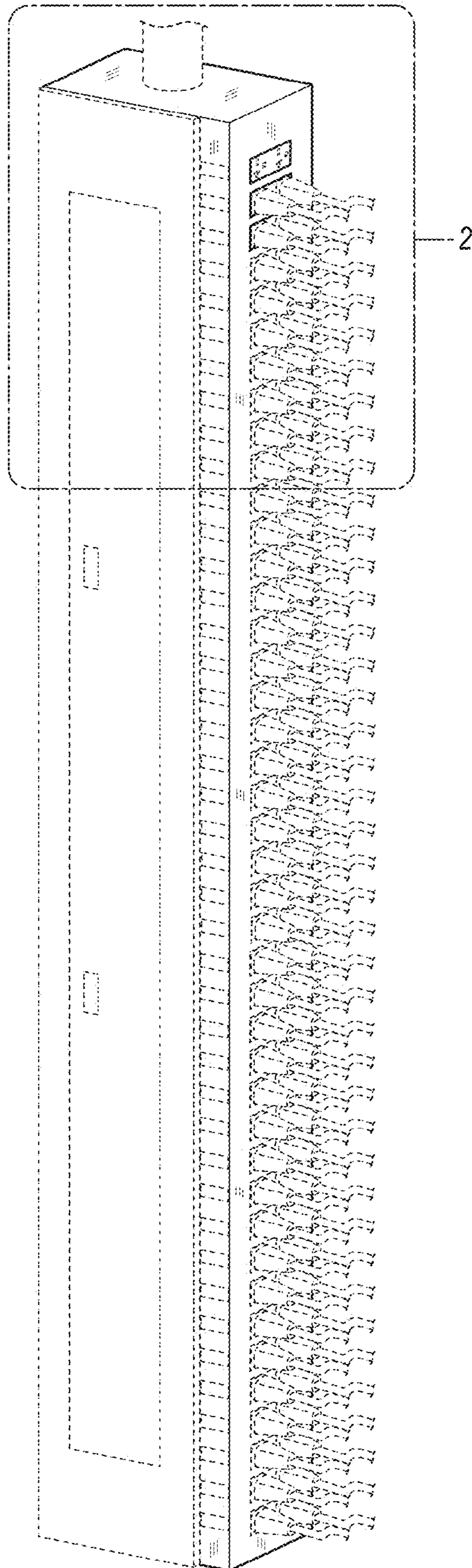

FIG. 1

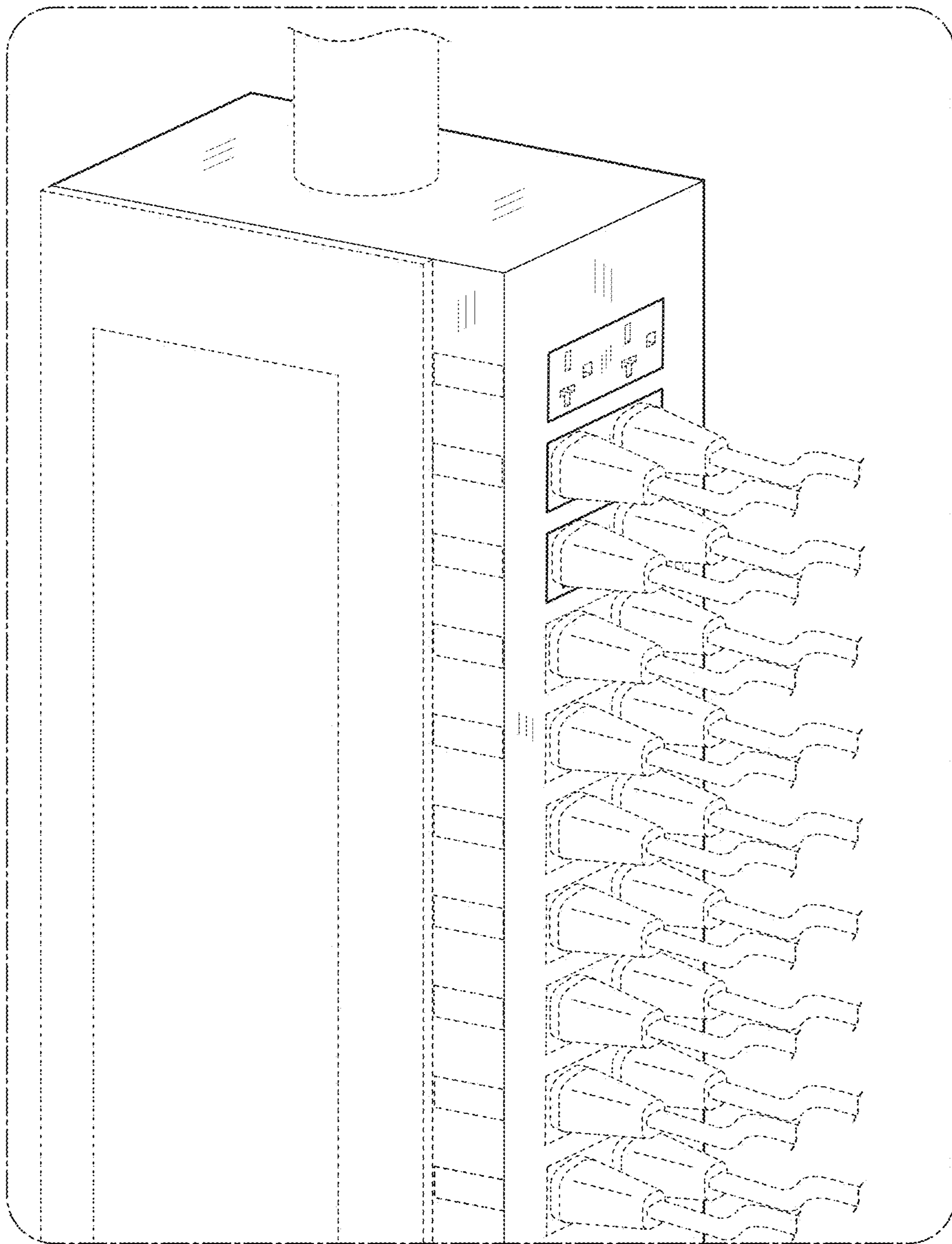

FIG. 2

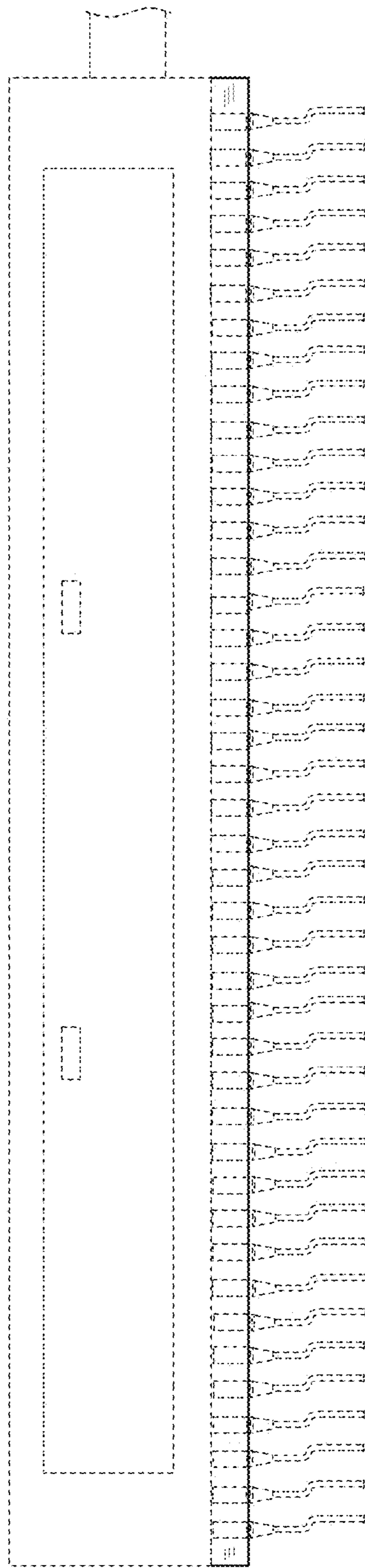

FIG. 3

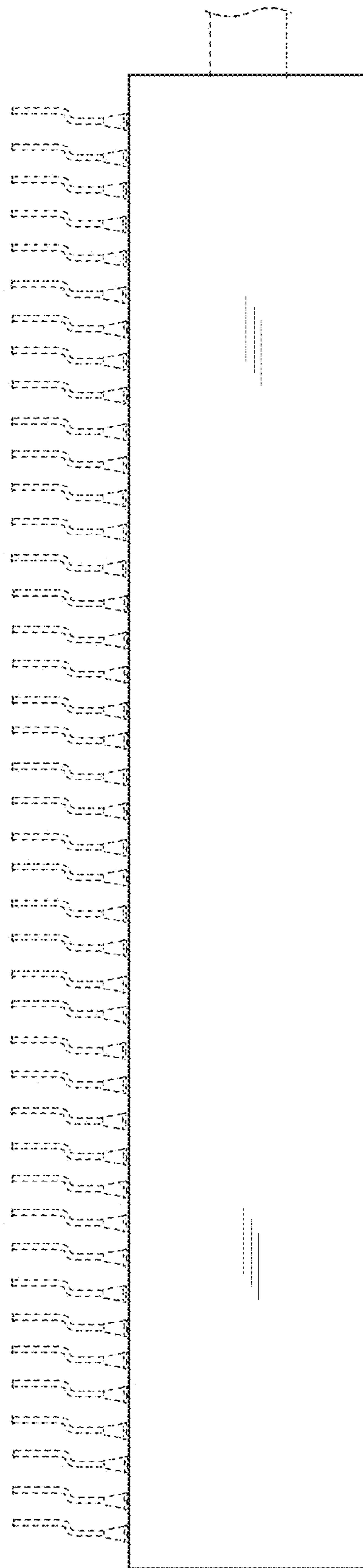

FIG. 4

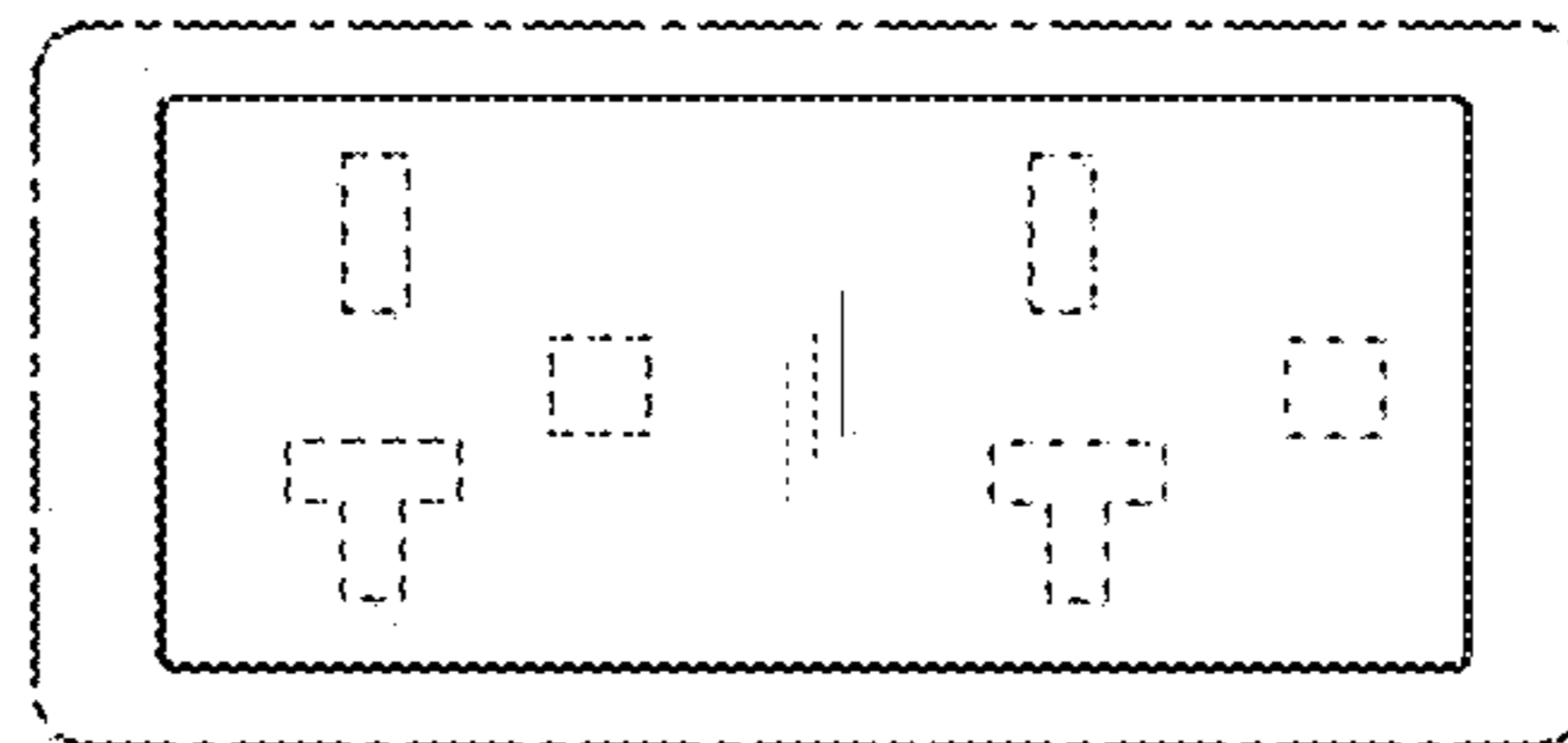
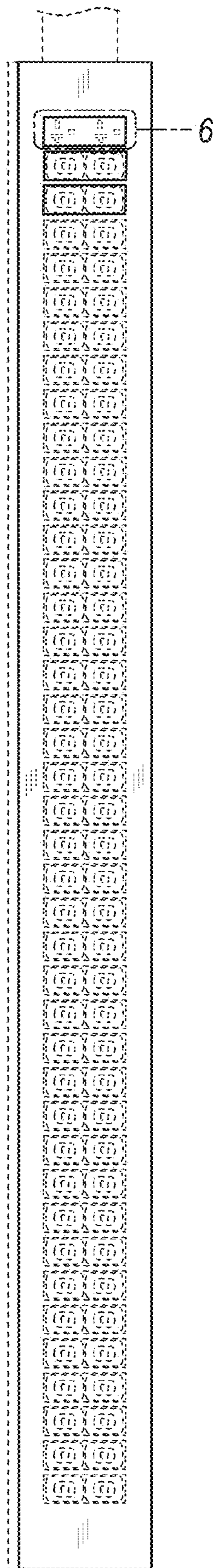

FIG. 6

FIG. 5

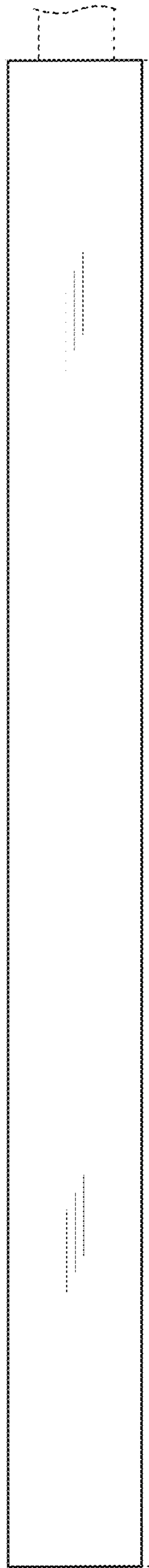

FIG. 7

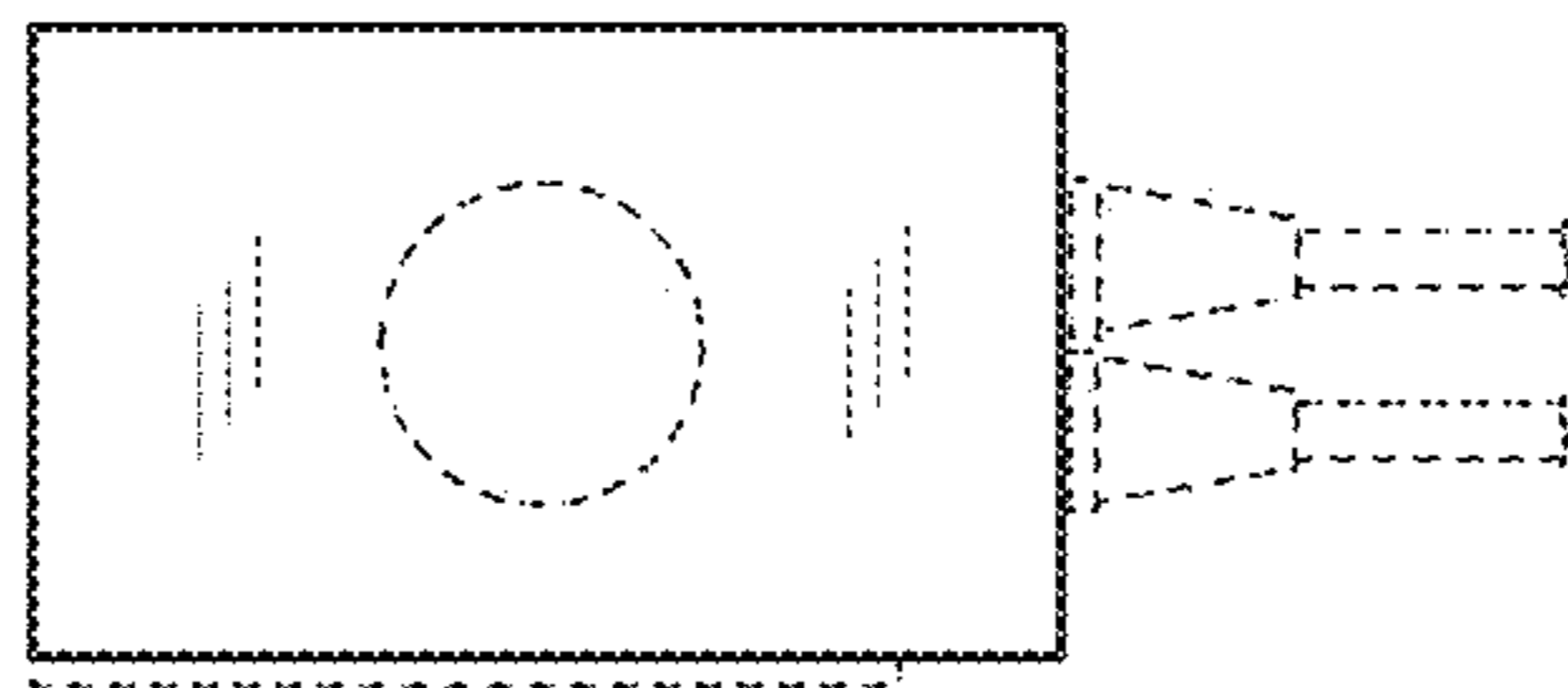

FIG. 8

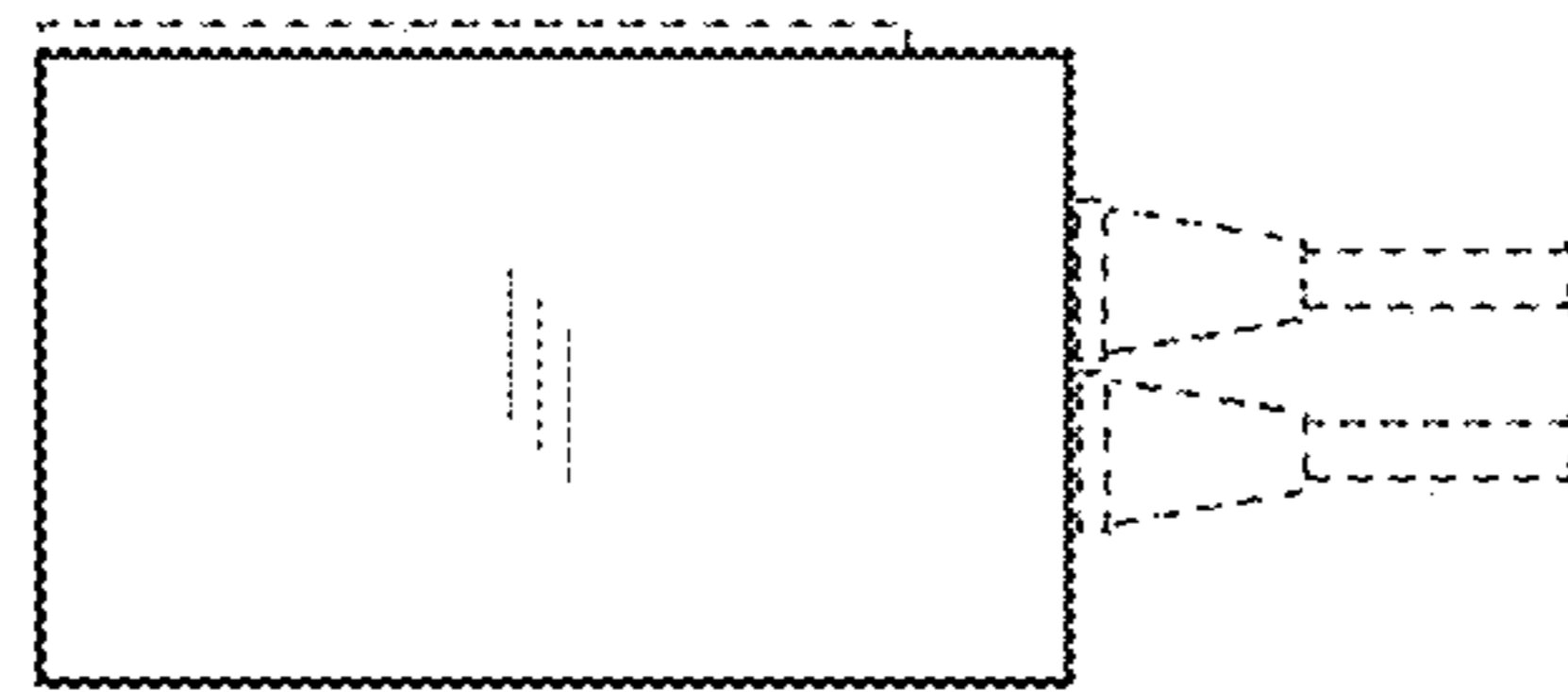

FIG. 9

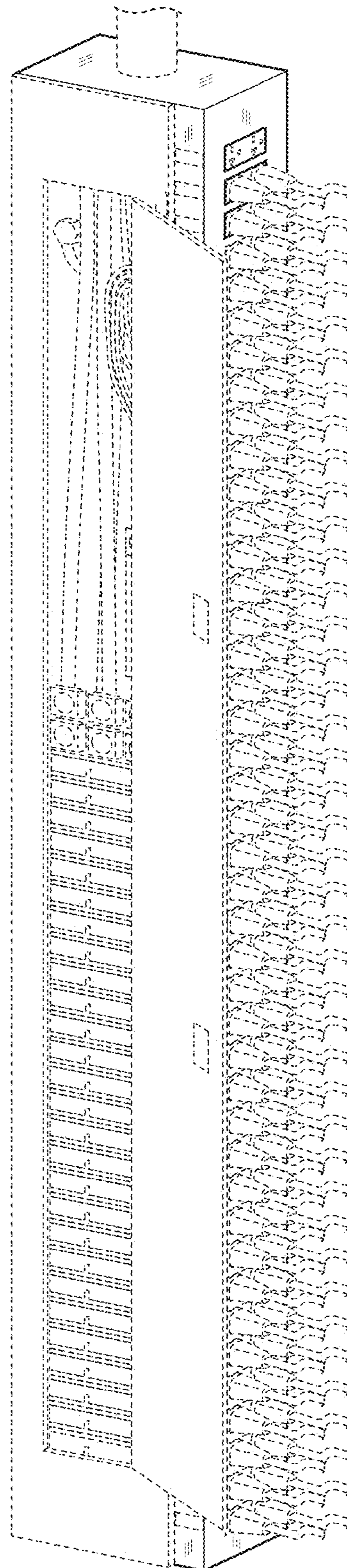

FIG. 10

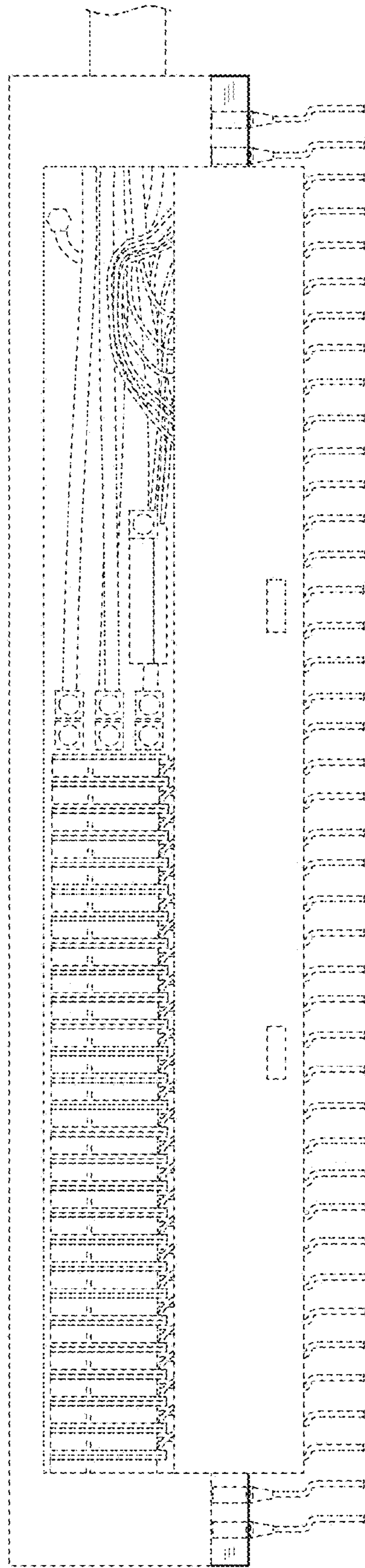

FIG. 11

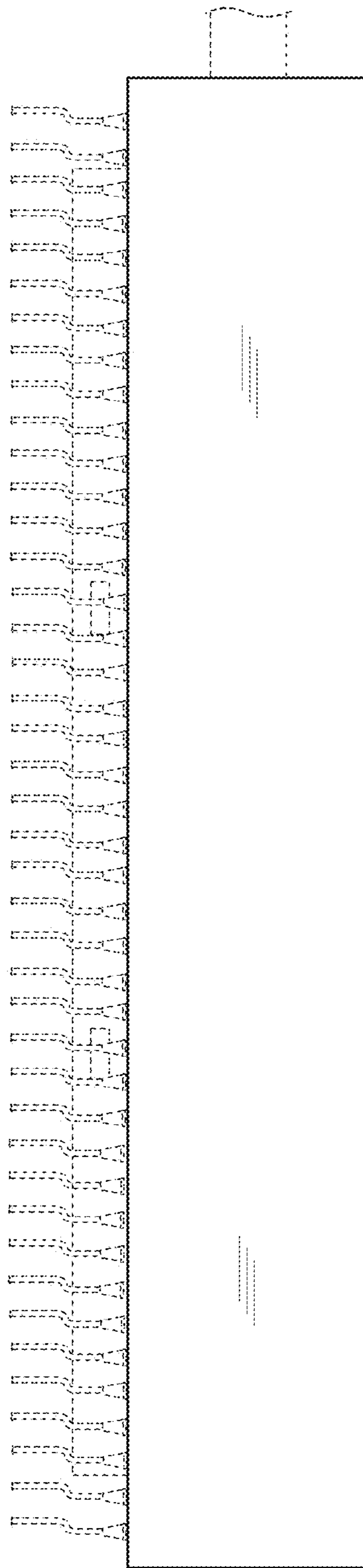

FIG. 12

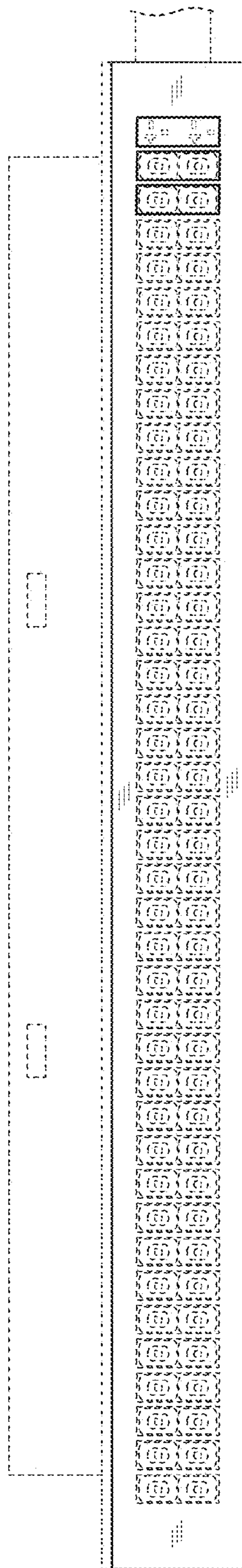

FIG. 13

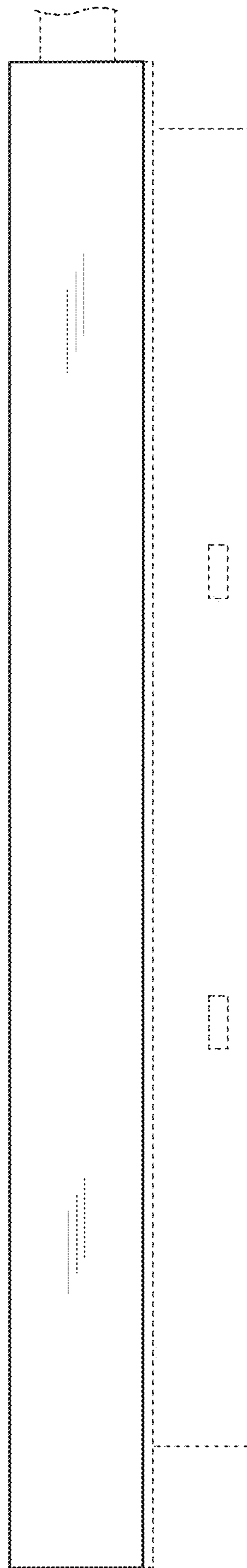

FIG. 14

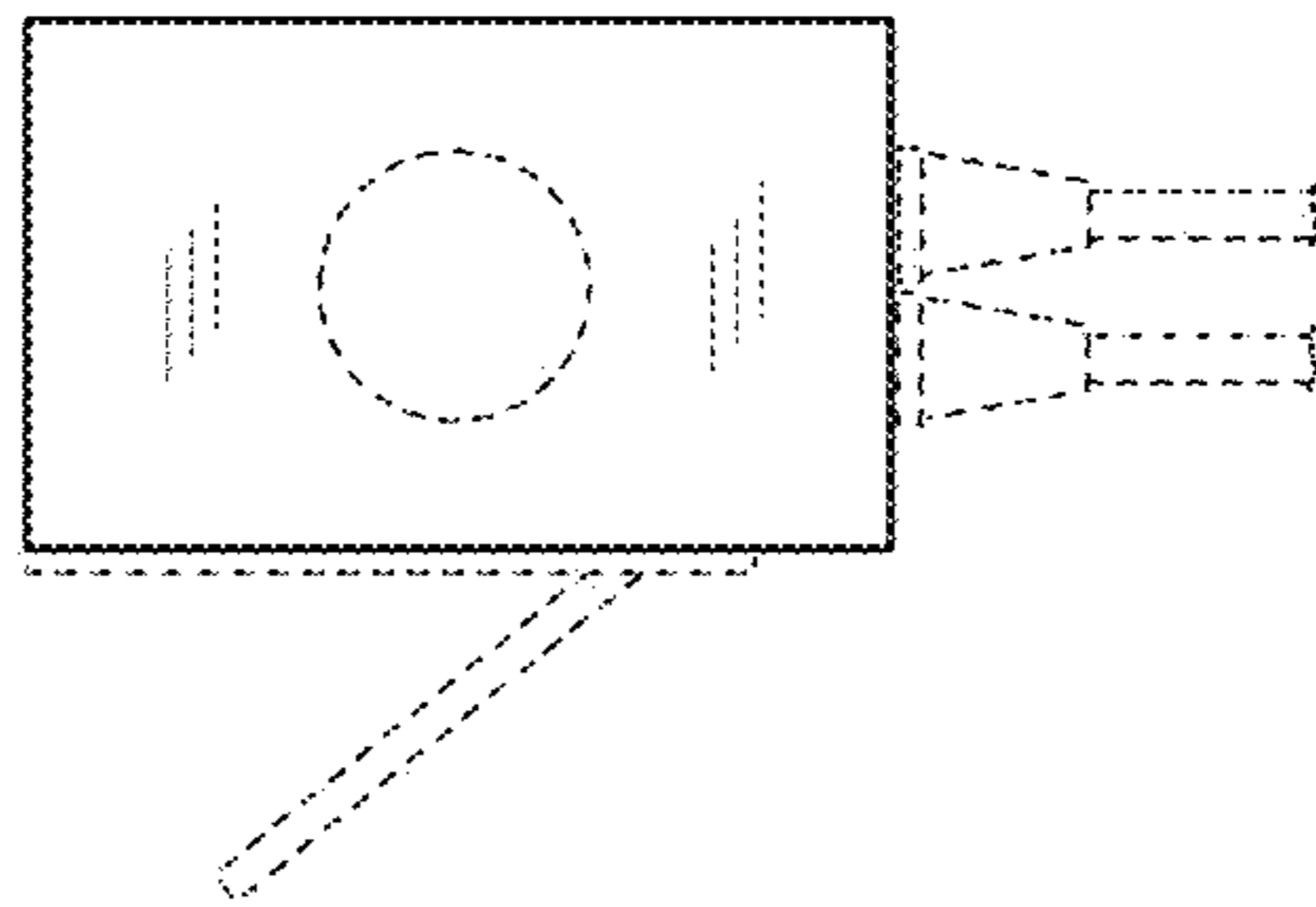

FIG. 15

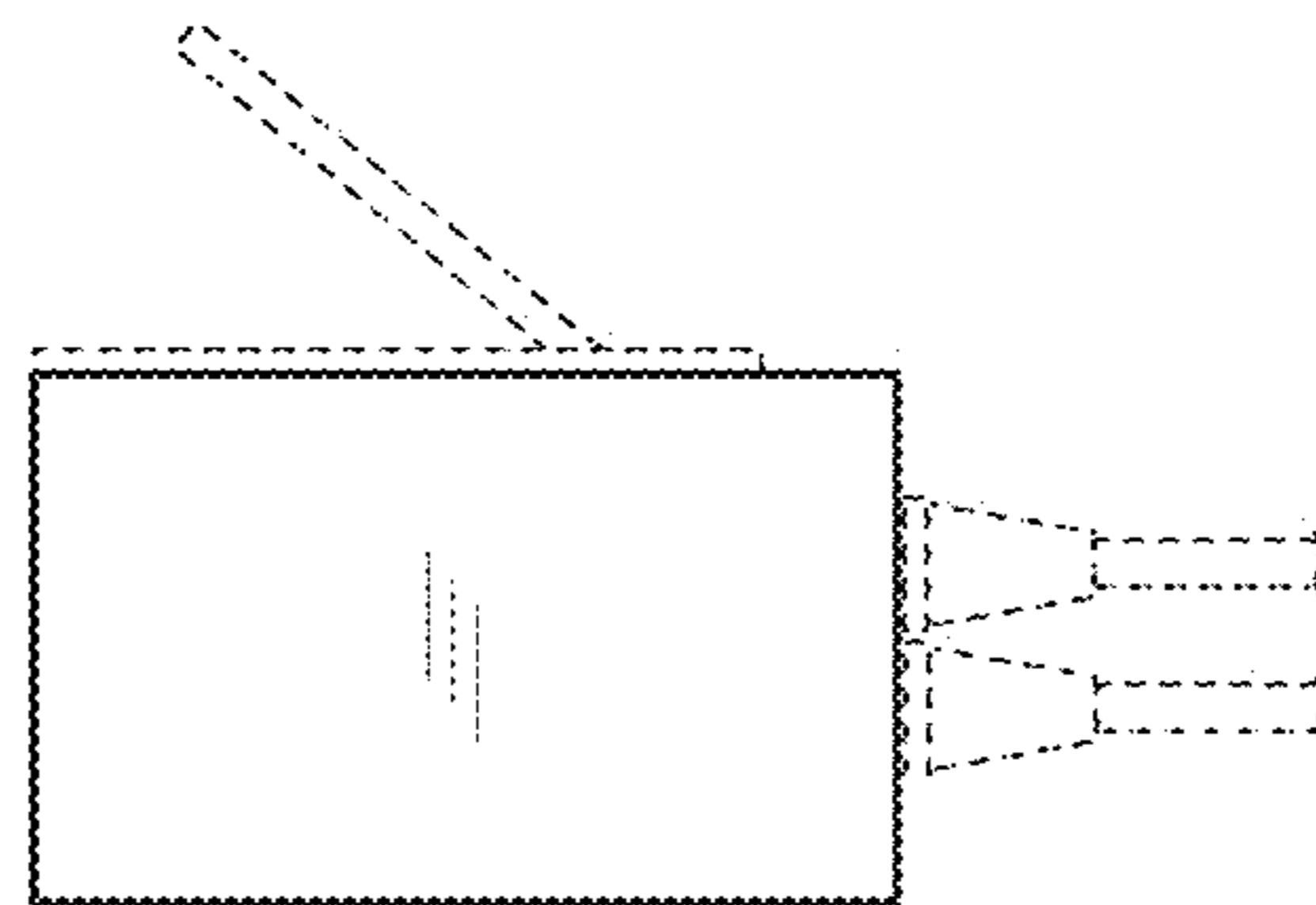

FIG. 16