



US00D968319S

(12) **United States Design Patent** (10) **Patent No.:** **US D968,319 S**
Tan (45) **Date of Patent:** **** Nov. 1, 2022**

(54) **CHARGER**

(71) Applicant: **Chunlun Tan**, Hechi (CN)

(72) Inventor: **Chunlun Tan**, Hechi (CN)

(**) Term: **15 Years**

(21) Appl. No.: **29/808,390**

(22) Filed: **Sep. 18, 2021**

(51) **LOC (13) Cl.** **13-02**

(52) **U.S. Cl.**
USPC **D13/107**

(58) **Field of Classification Search**

USPC D13/103, 107, 108, 110, 118, 151, 153,
D13/154, 155, 184

CPC Y02E 60/10; Y02E 60/50; H01M 50/10;
H01M 50/107; H01M 50/557; H01M
50/209; H01M 50/502; H01M 2220/30;
H02J 7/00; H02J 7/0003; H02J 7/0011;
H02J 7/0013; H02J 7/0054; H02J 7/0055;
H02J 7/0057

See application file for complete search history.

(56) **References Cited**

U.S. PATENT DOCUMENTS

D673,110 S	12/2012	Sasada et al.	
D718,234 S *	11/2014	Rautiainen	D13/108
D725,034 S *	3/2015	Chen	D13/108
D735,131 S *	7/2015	Akana	D13/108
D737,762 S *	9/2015	Aumiller	D13/108
D746,772 S *	1/2016	Aumiller	D13/108
D747,267 S *	1/2016	Aumiller	D13/108
D786,193 S *	5/2017	Akana	D13/108
D798,807 S *	10/2017	Shi	D13/108
D806,020 S *	12/2017	Lu	D13/107

(Continued)

Primary Examiner — Christy Nemeth

(57) **CLAIM**

The ornamental design for a charger, as shown and described.

DESCRIPTION

FIG. 1 is a top, front and right perspective view of a first embodiment of a charger showing my new design;

FIG. 2 is a rear, left and bottom perspective view thereof;

FIG. 3 is a front view thereof;

FIG. 4 is a rear view thereof;

FIG. 5 is a left side view thereof;

FIG. 6 is a right side view thereof;

FIG. 7 is a top plan view thereof;

FIG. 8 is a bottom plan view thereof;

FIG. 9 is a top plan view thereof showing the charger in an environment of use;

FIG. 10 is a top plan view thereof showing the charger in a state of use;

FIG. 11 is a top, front and right perspective view of a second embodiment of a charger showing my new design;

FIG. 12 is a rear, left and bottom perspective view thereof;

FIG. 13 is a front view thereof;

FIG. 14 is a rear view thereof;

FIG. 15 is a left side view thereof;

FIG. 16 is a right side view thereof;

FIG. 17 is a top plan view thereof;

FIG. 18 is a bottom plan view thereof;

FIG. 19 is a top plan view thereof showing the charger in an environment of use; and,

FIG. 20 is a top plan view thereof showing the charger in a state of use.

The broken lines illustrating a watch in FIGS. 9-10, 19-20 are for the purposes of illustrating environmental subject matter and form no part of the claimed design. The remaining broken lines in the drawings are for the purpose of illustrating portions of the charger that form no part of the claimed design. The charger is shown with a symbolic break in its length. The appearance of any portion of the article between the break lines forms no part of the claimed design.

1 Claim, 16 Drawing Sheets

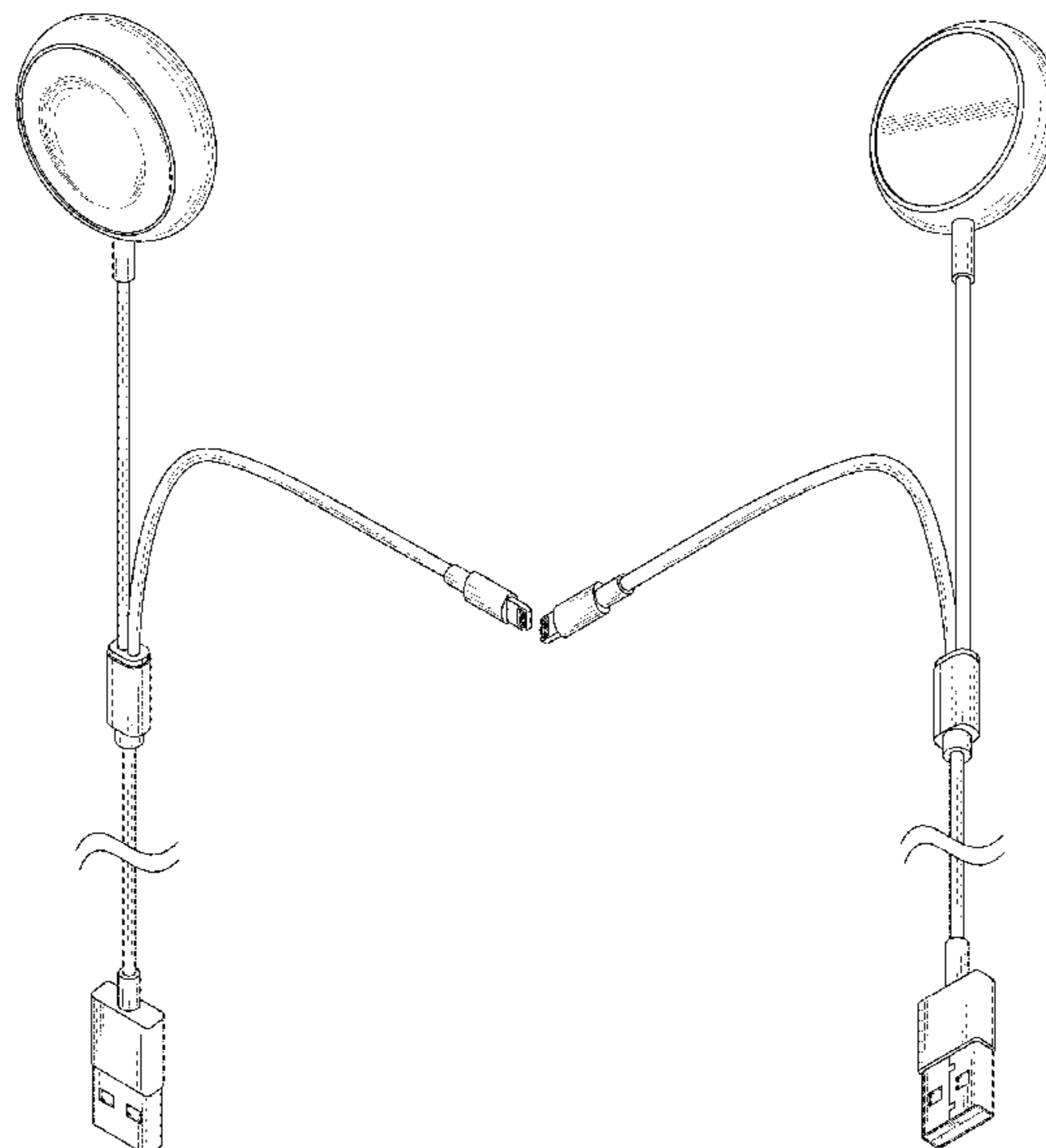

(56)

References Cited

U.S. PATENT DOCUMENTS

D850,372 S *	6/2019	Kong	D13/108
D869,391 S *	12/2019	Roberts	D13/108
D890,095 S *	7/2020	Liao	D13/110
D899,359 S *	10/2020	Zhang	D13/108
D900,027 S *	10/2020	Reilly	D13/108
D908,620 S *	1/2021	Akana	D13/108
D911,276 S *	2/2021	Li	D13/108
D935,402 S *	11/2021	Qiu	D13/108
D936,576 S *	11/2021	Joung	D13/108
D937,765 S *	12/2021	Akana	D13/107
D943,524 S *	2/2022	Zheng	D13/108
D946,506 S *	3/2022	Cheng	D13/107
D946,507 S *	3/2022	Cheng	D13/107
D946,508 S *	3/2022	Cheng	D13/107
D948,427 S *	4/2022	Lin	D13/108
D958,071 S *	7/2022	Yang	D13/108
D958,072 S *	7/2022	Yang	D13/108
D958,737 S *	7/2022	Turksu	D13/108

* cited by examiner

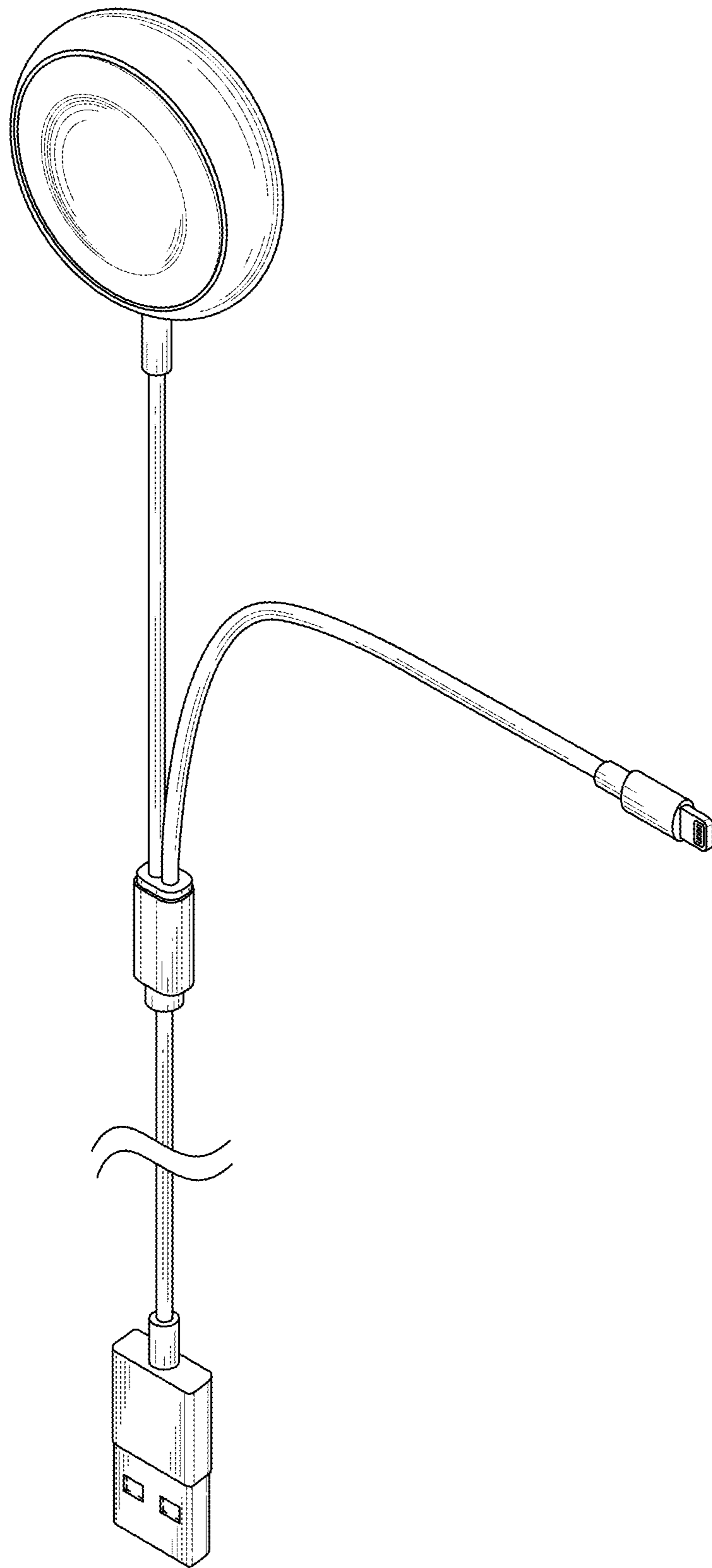

FIG. 1

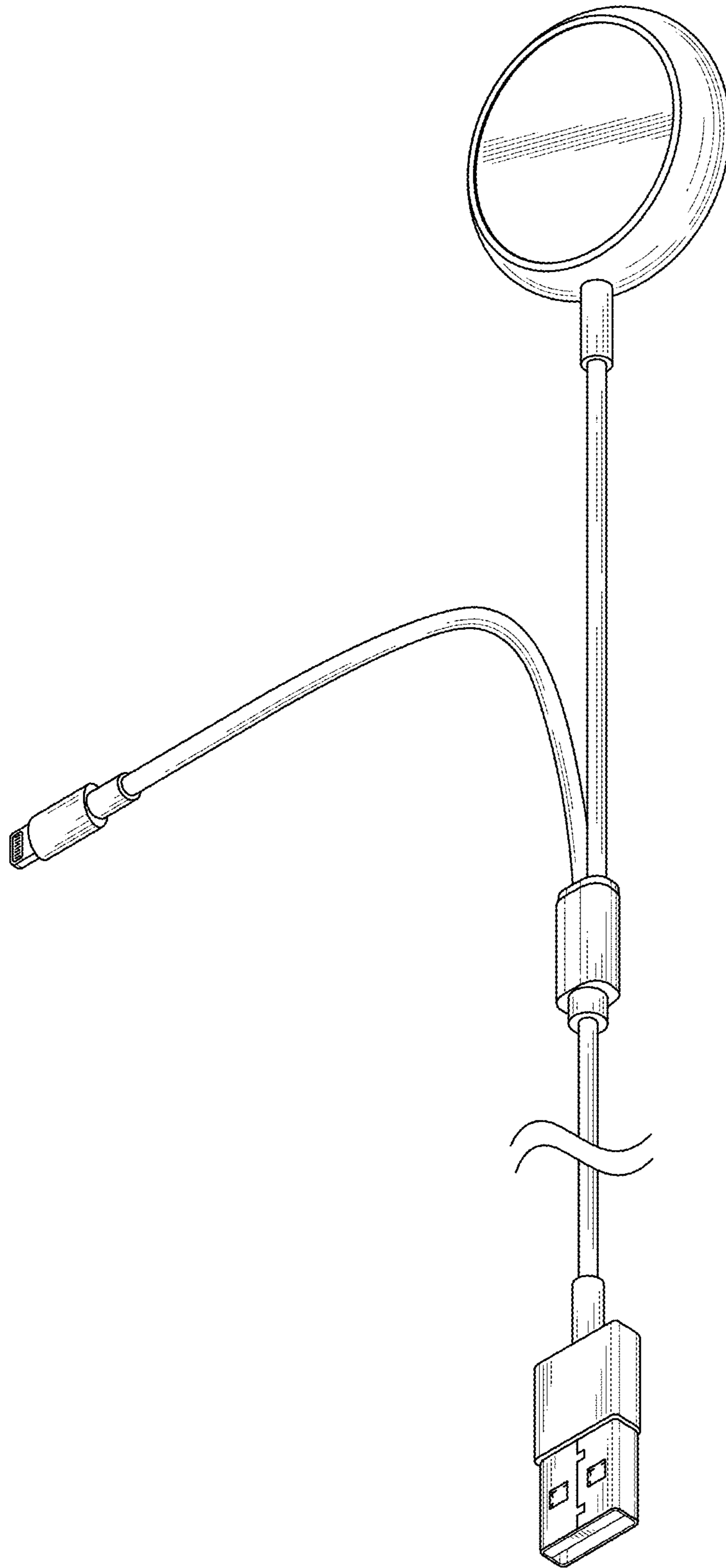

FIG. 2

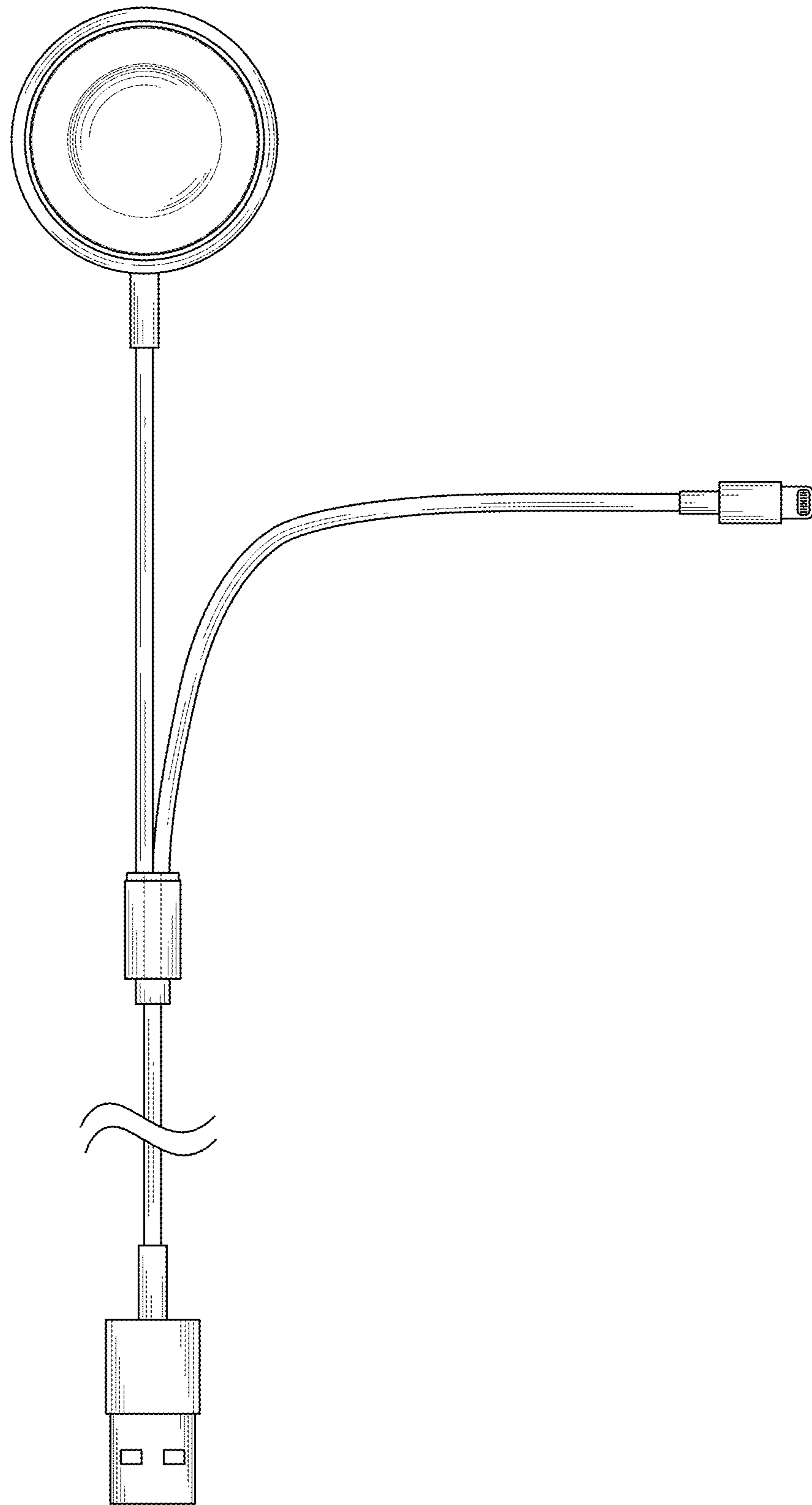

FIG. 3

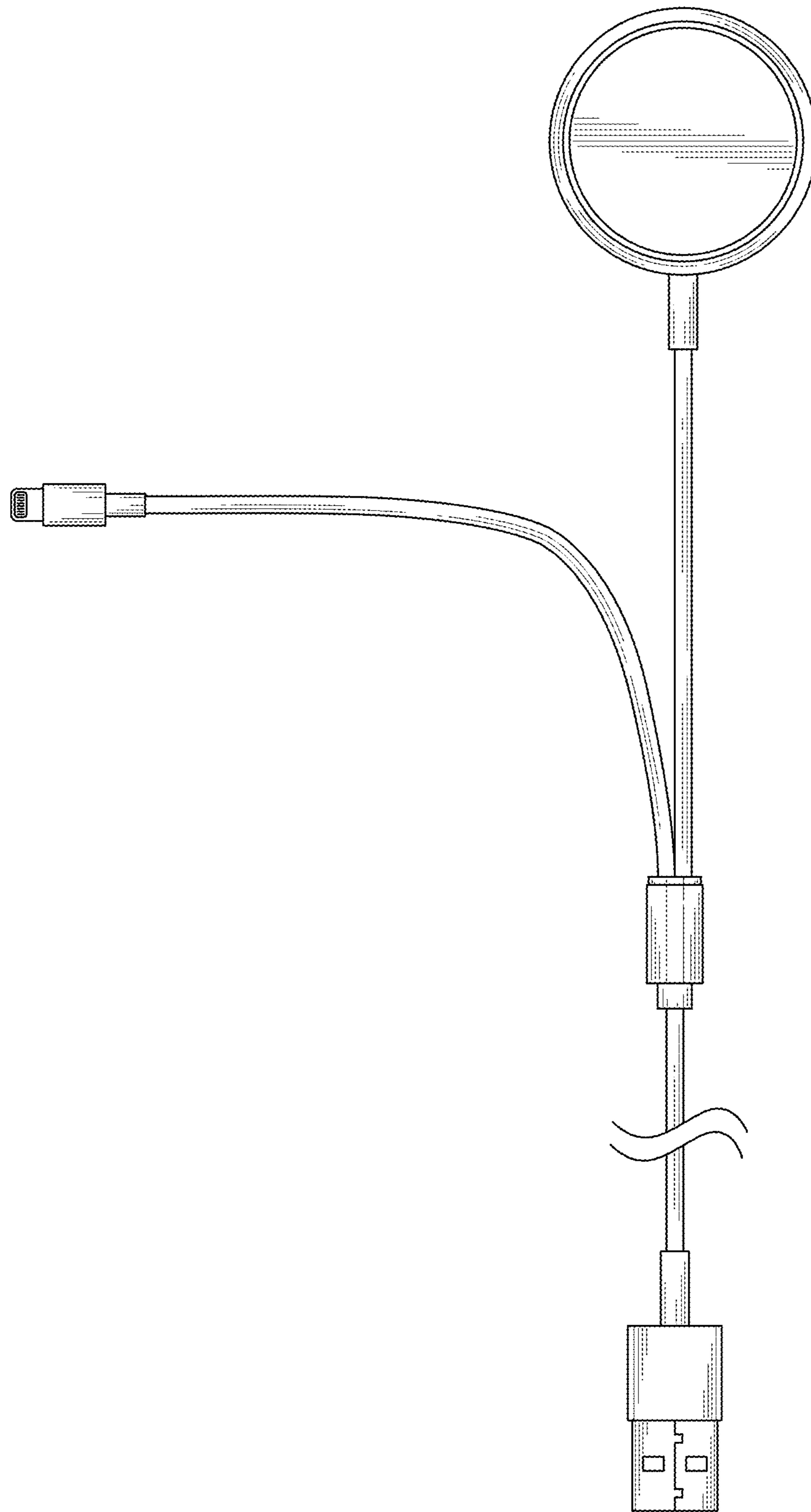

FIG. 4

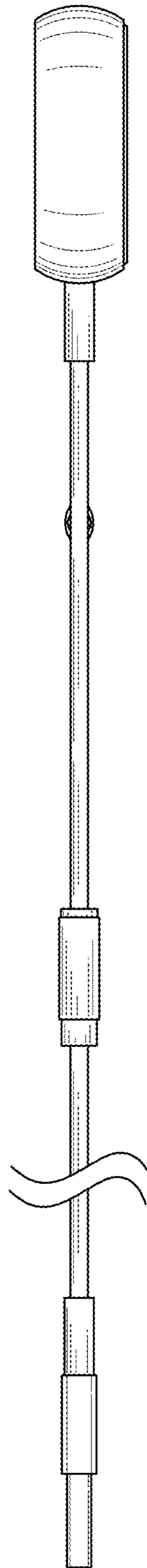

FIG. 5

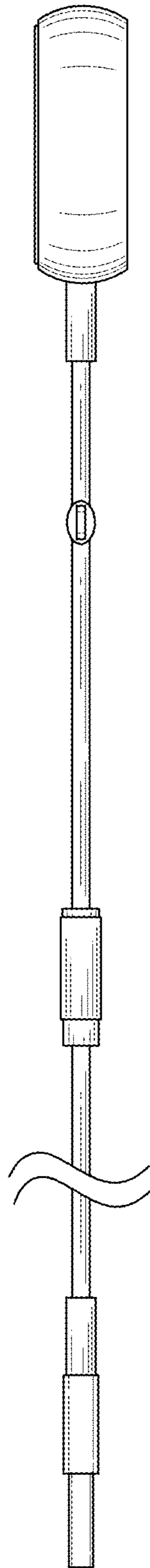

FIG. 6

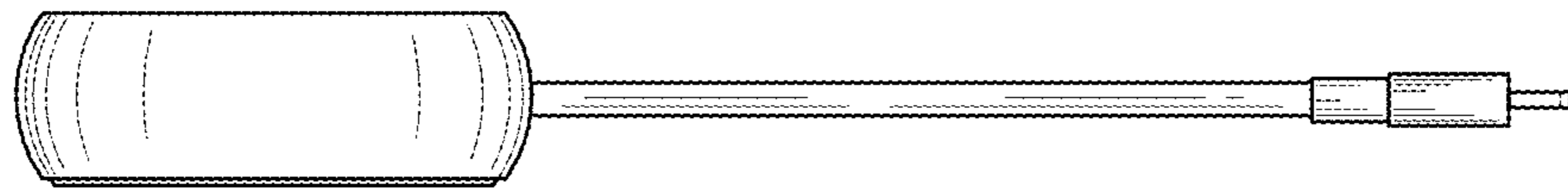

FIG. 7

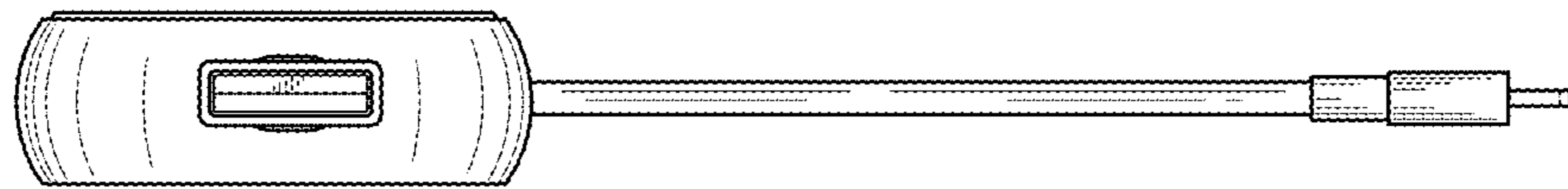

FIG. 8

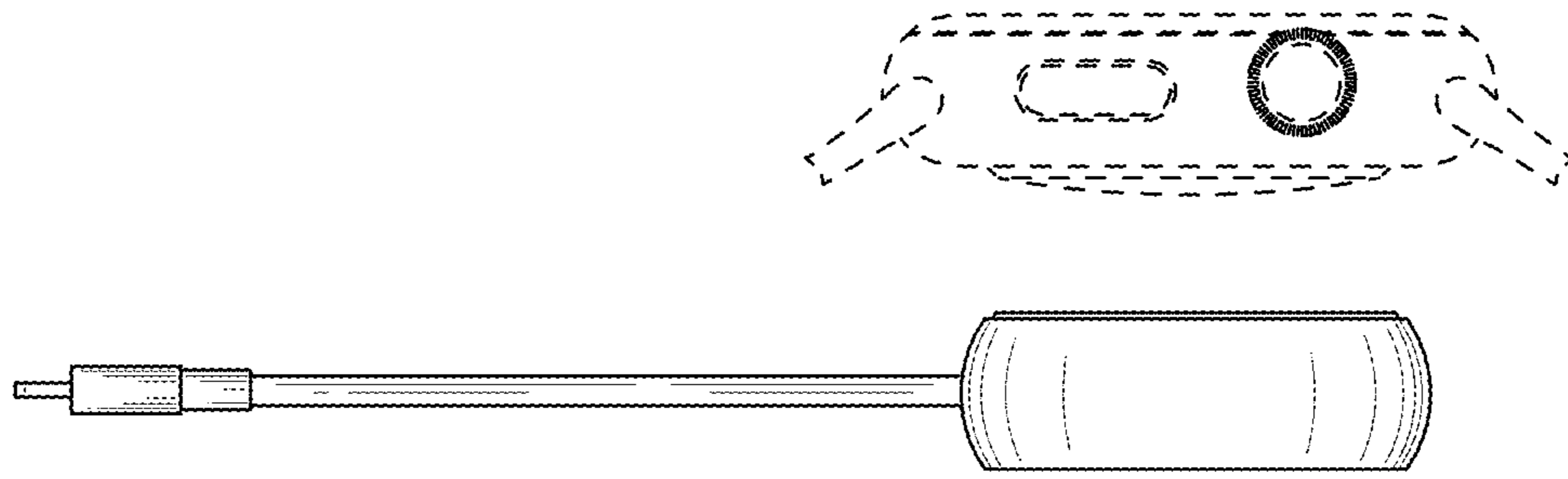

FIG. 9

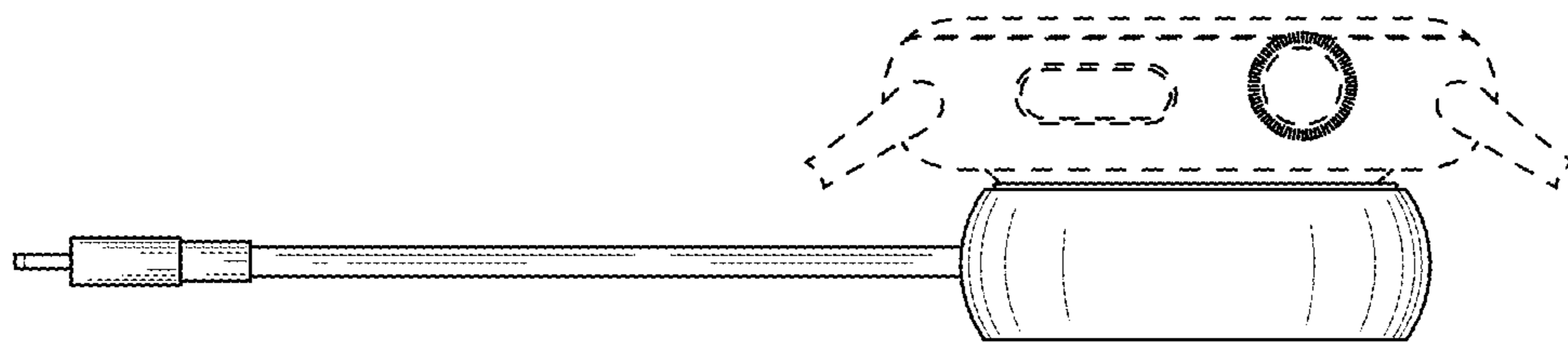

FIG. 10

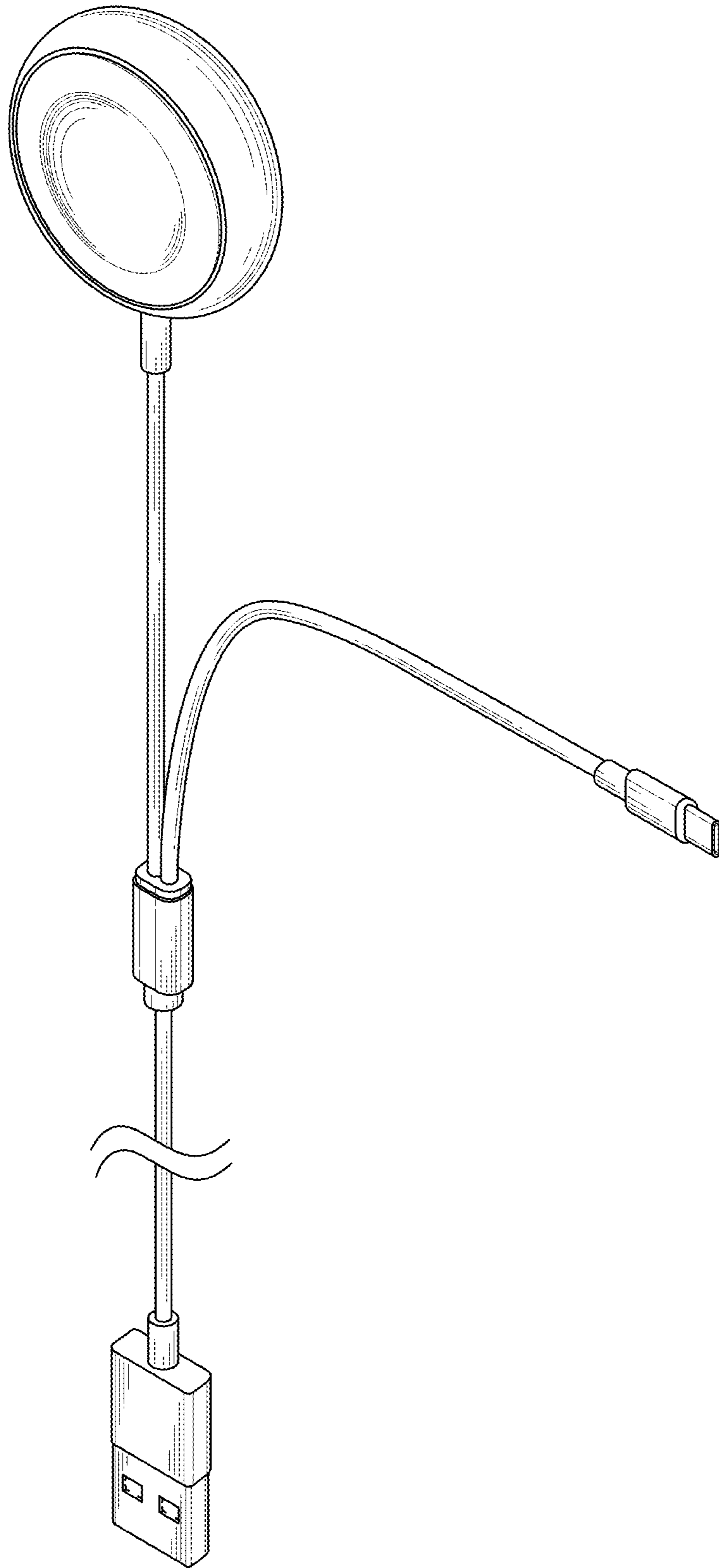

FIG. 11

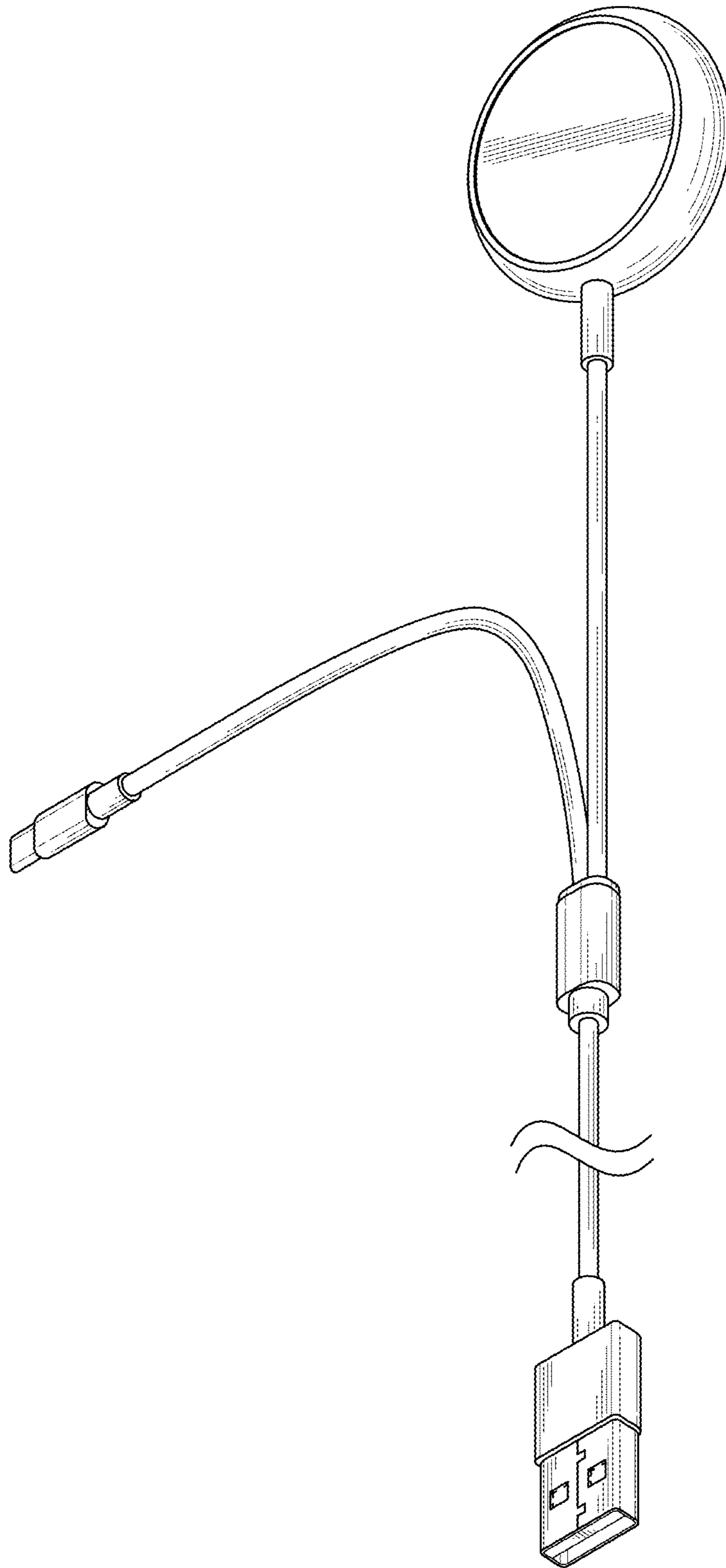

FIG. 12

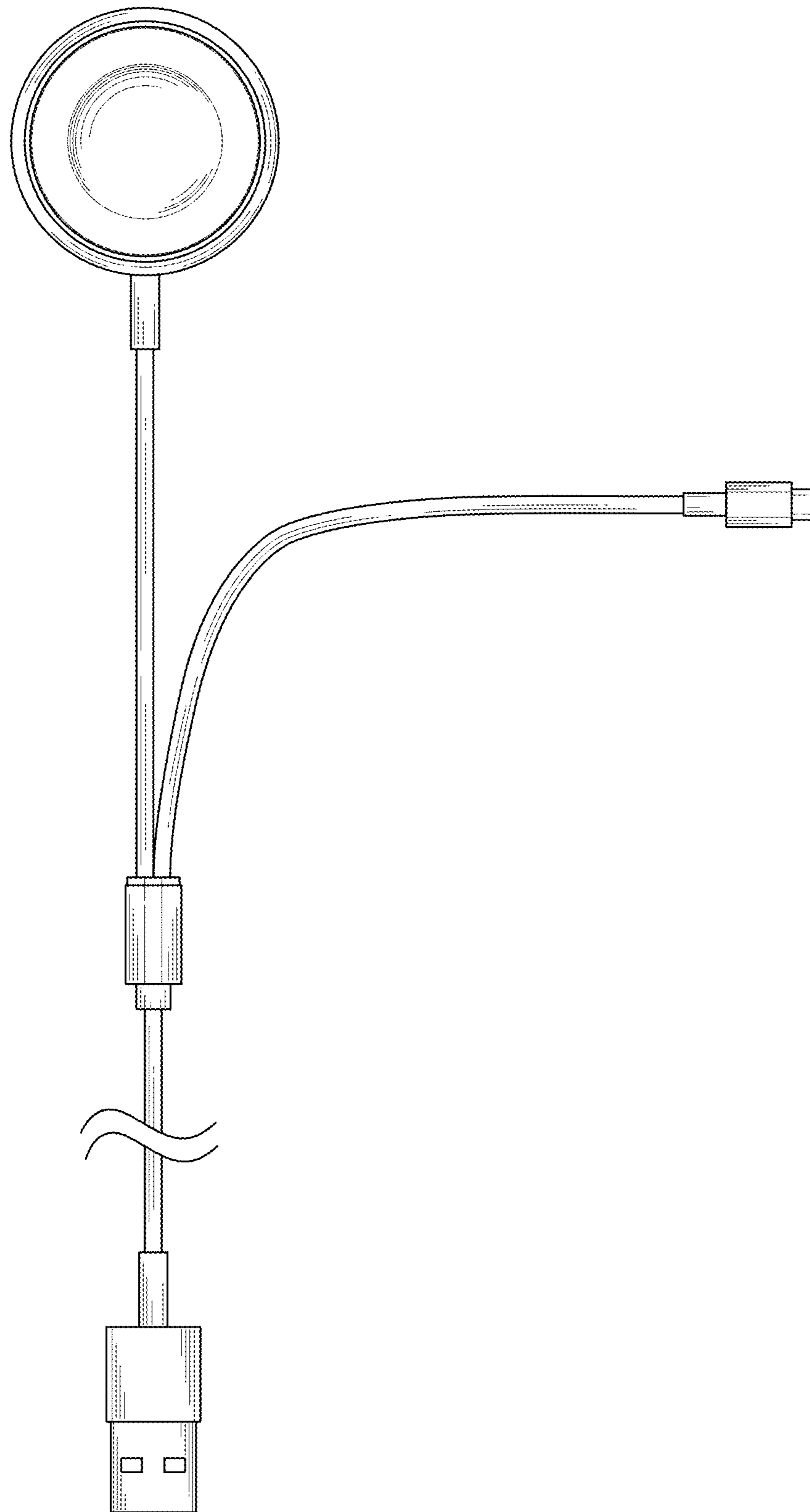

FIG. 13

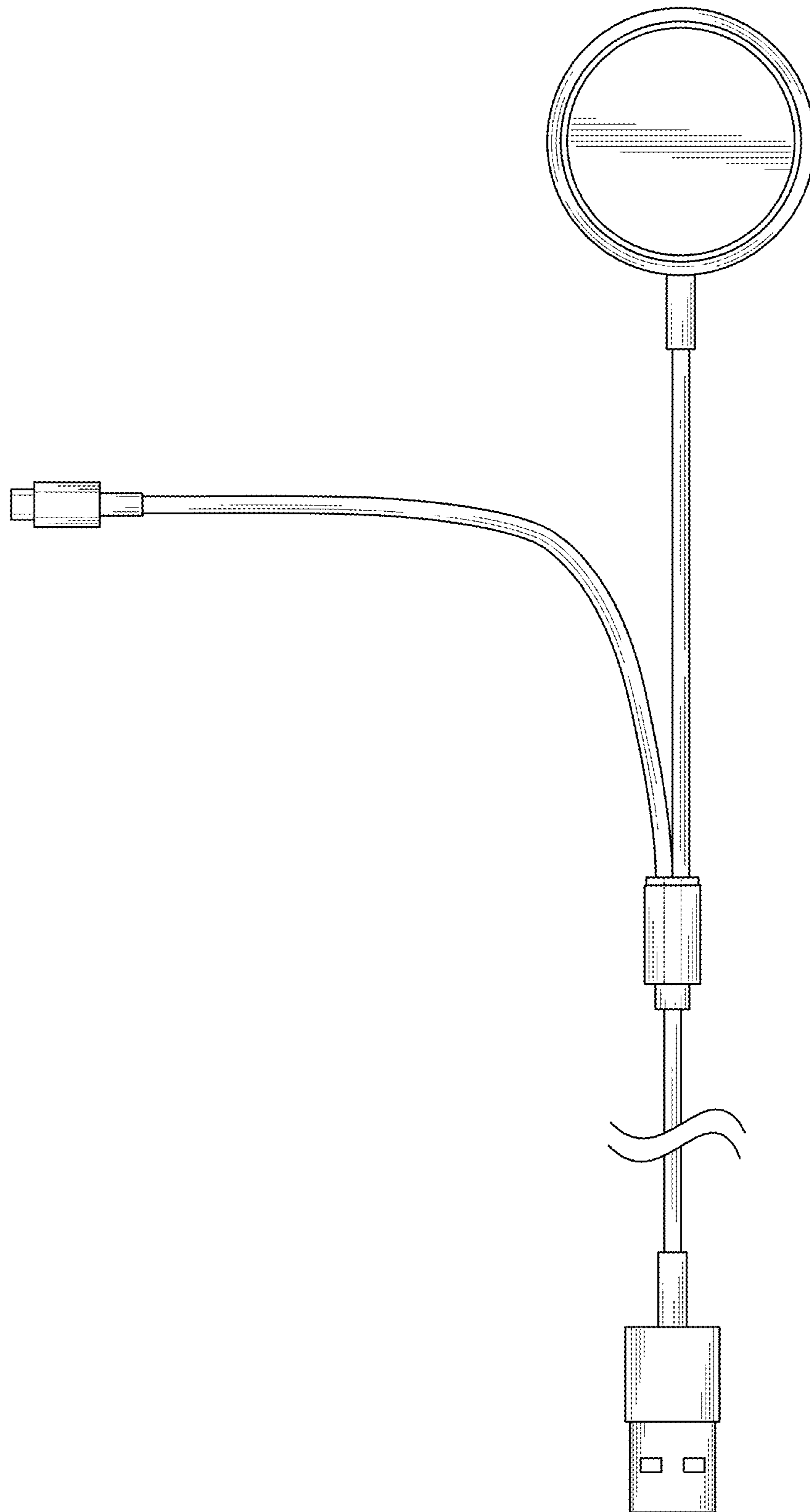

FIG. 14

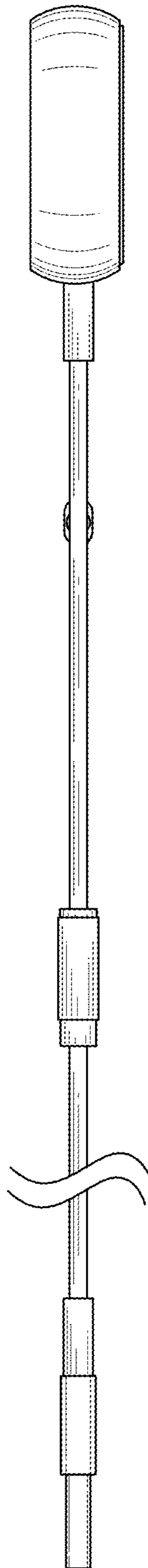

FIG. 15

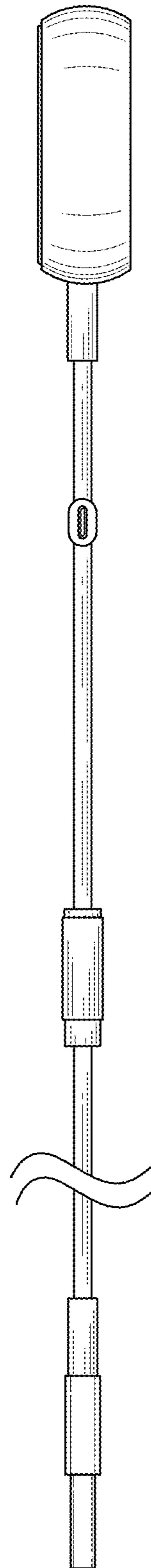

FIG. 16

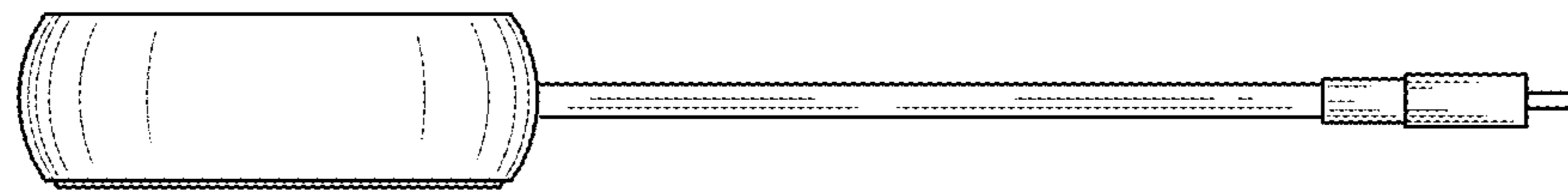

FIG. 17

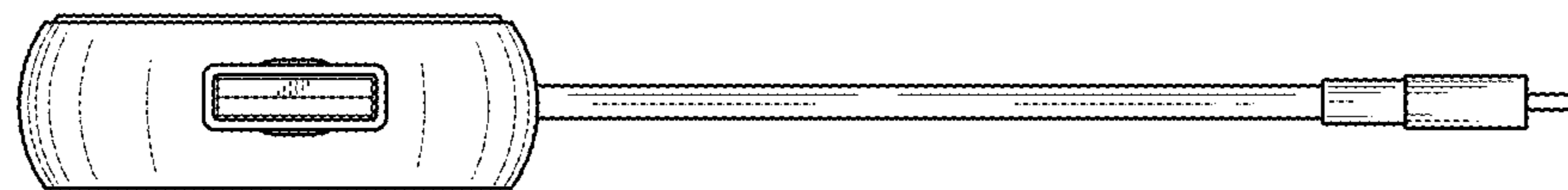

FIG. 18

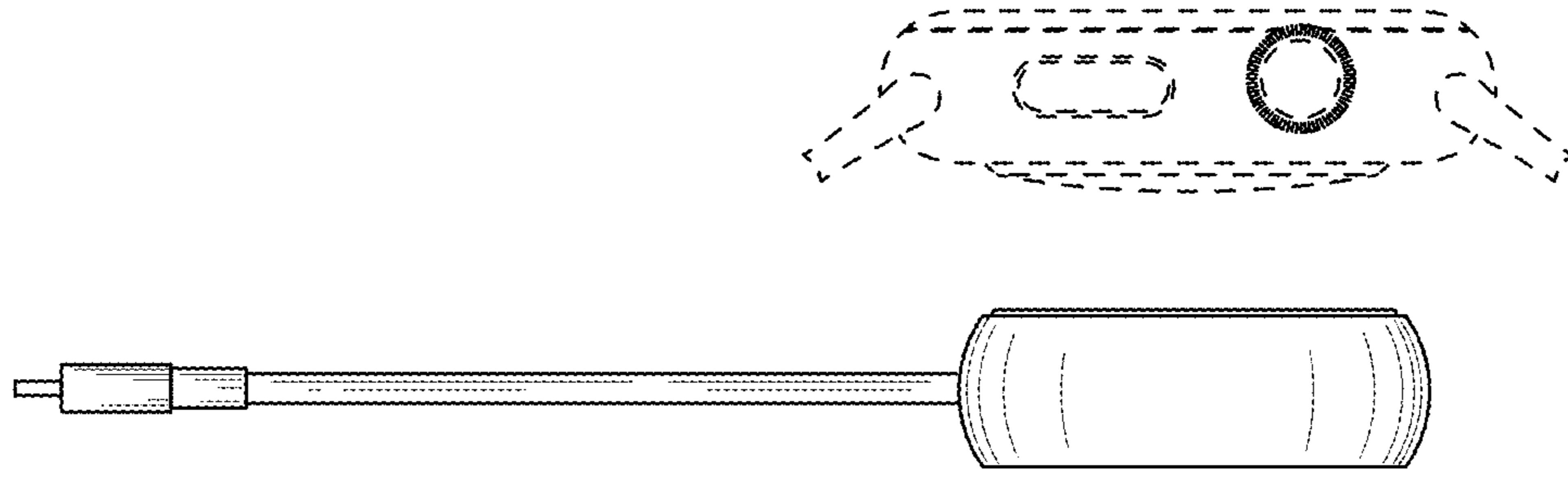

FIG. 19

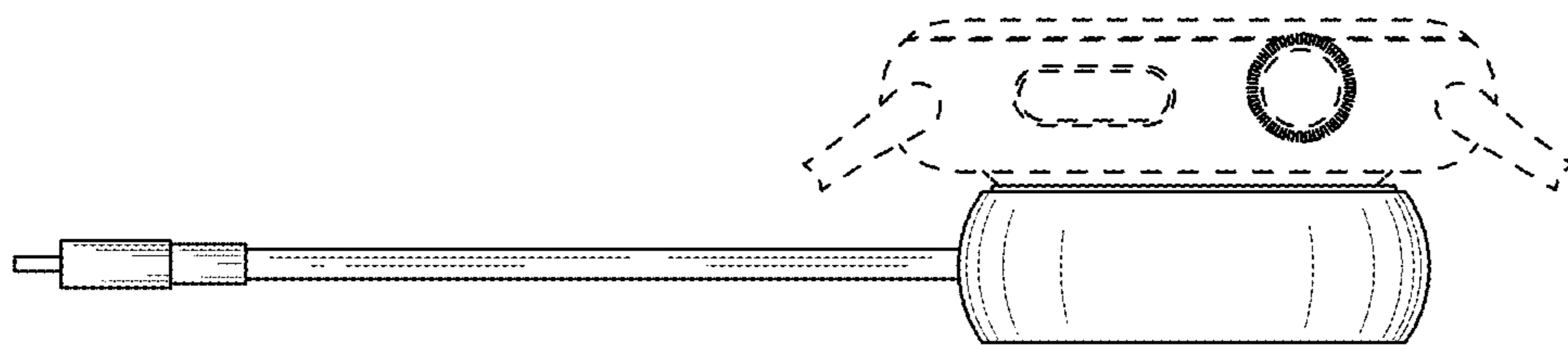

FIG. 20