



US00D968183S

(12) **United States Design Patent**
Chen

(10) **Patent No.:** **US D968,183 S**

(45) **Date of Patent:** **** Nov. 1, 2022**

(54) **MINI BOLT CUTTERS**

(71) Applicant: **JS Products, Inc.**, Las Vegas, NV (US)

(72) Inventor: **Chungeng Chen**, Las Vegas, NV (US)

(73) Assignee: **JS Products, Inc.**, Las Vegas, NV (US)

(**) Term: **15 Years**

(21) Appl. No.: **29/725,057**

(22) Filed: **Feb. 21, 2020**

(51) **LOC (13) Cl.** **08-05**

(52) **U.S. Cl.**
USPC **D8/52**

(58) **Field of Classification Search**
USPC D8/51-60
CPC B26B 17/02
See application file for complete search history.

(56) **References Cited**

U.S. PATENT DOCUMENTS

- D50,029 S * 12/1916 Porter D8/58
- D201,915 S * 8/1965 Werner D8/58
- D416,458 S * 11/1999 Kun-Meng D8/52

D597,811 S * 8/2009 Yu D8/52
2019/0299388 A1* 10/2019 Blumenthal B25G 1/063

* cited by examiner

Primary Examiner — Deanna L Pratt

(74) *Attorney, Agent, or Firm* — Weide & Miller, Ltd.

(57) **CLAIM**

The ornamental design for mini bolt cutters, as shown and described.

DESCRIPTION

FIG. 1 is a front, top, left perspective view of the mini bolt cutters, showing the new design.

FIG. 2 is a rear, bottom, right perspective view of the mini bolt cutters shown in FIG. 1.

FIG. 3 is a top view of the mini bolt cutters shown in FIG. 1.

FIG. 4 is a front view of the mini bolt cutters shown in FIG. 1.

FIG. 5 is a bottom view of the mini bolt cutters shown in FIG. 1.

FIG. 6 is a rear view of the mini bolt cutters shown in FIG. 1.

FIG. 7 is a left-side view of the mini bolt cutters shown in FIG. 1; and,

FIG. 8 is a right-side view of the mini bolt cutters shown in FIG. 1.

1 Claim, 3 Drawing Sheets

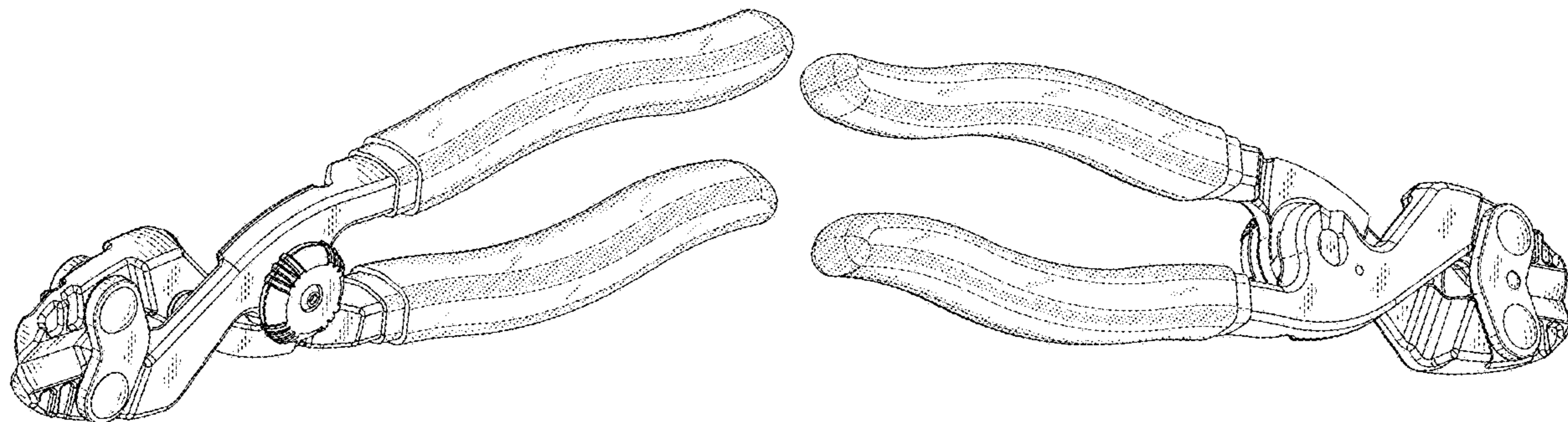

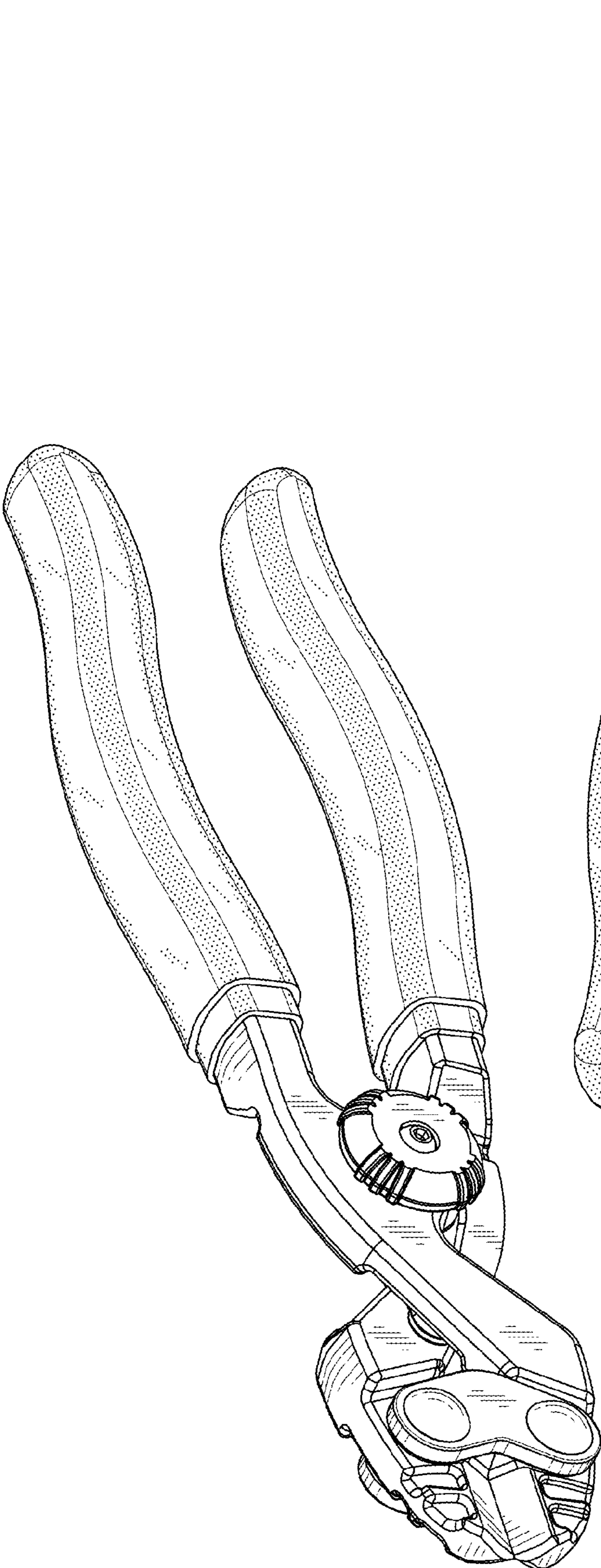

FIG. 1

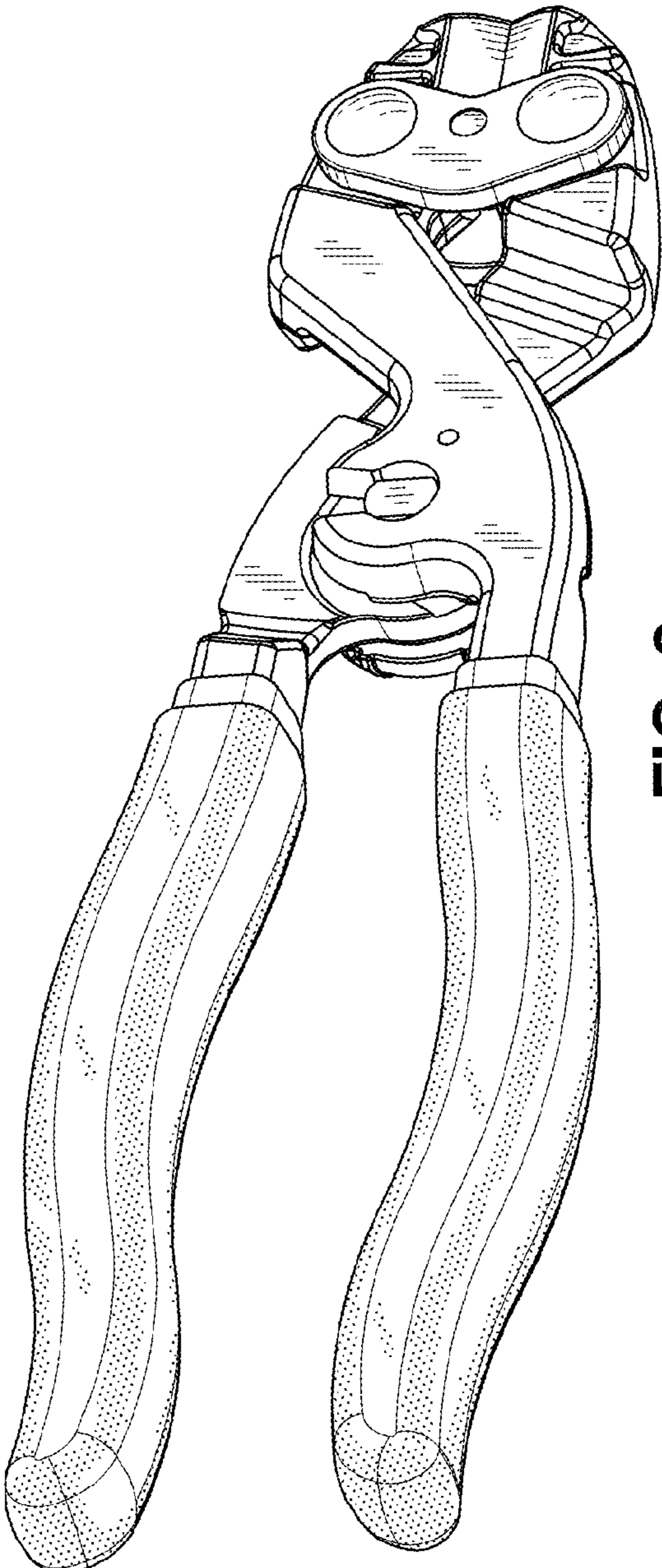

FIG. 2

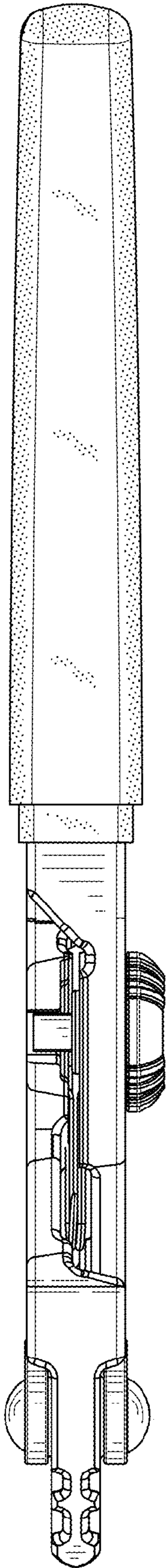

FIG. 3

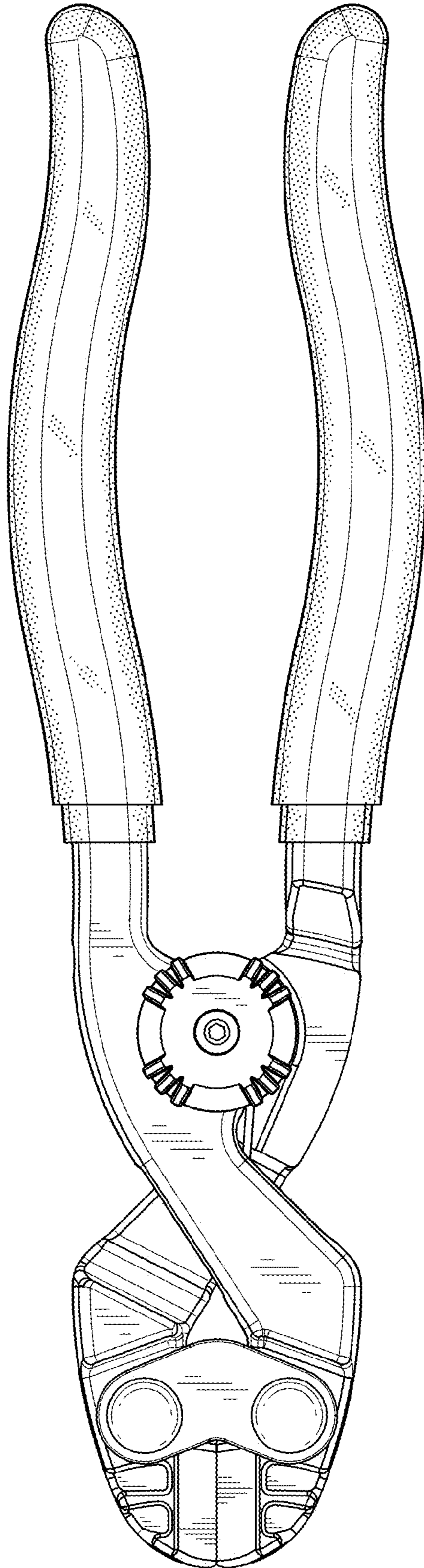

FIG. 4

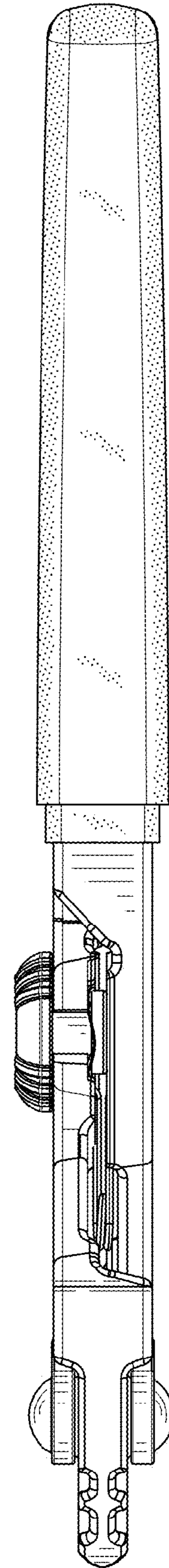

FIG. 5

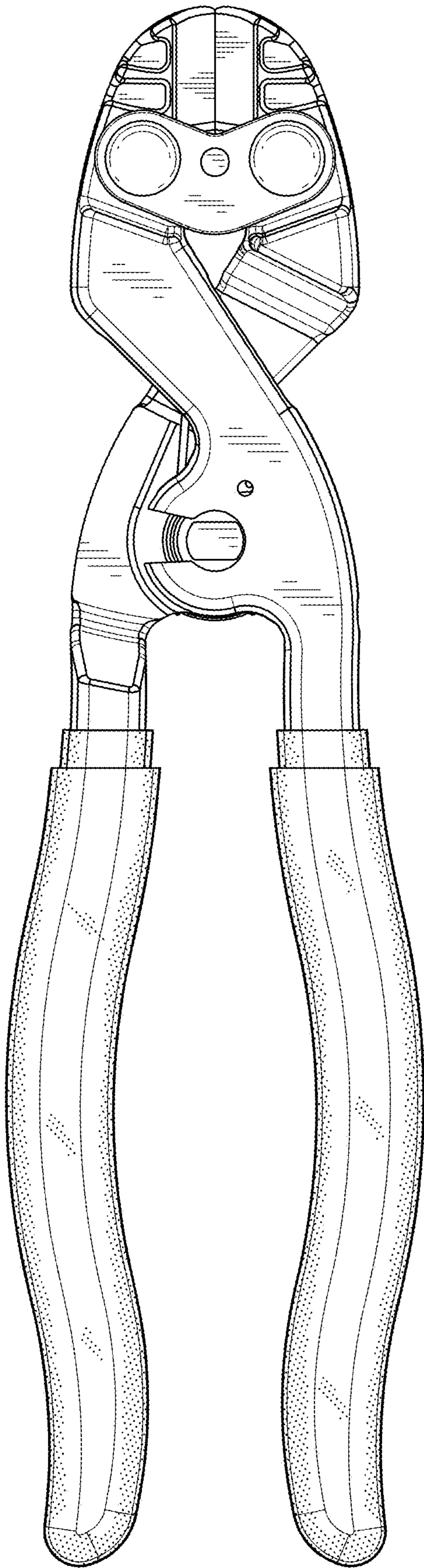

FIG. 6

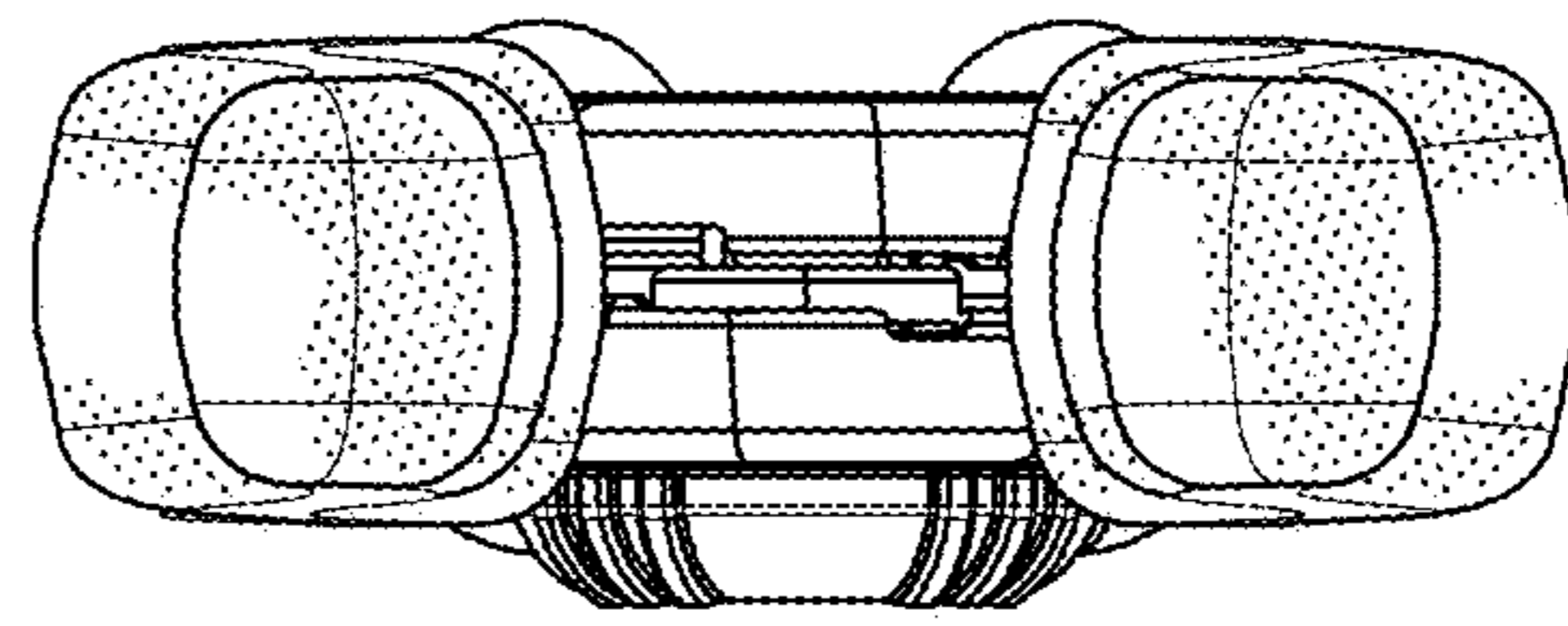

FIG. 8

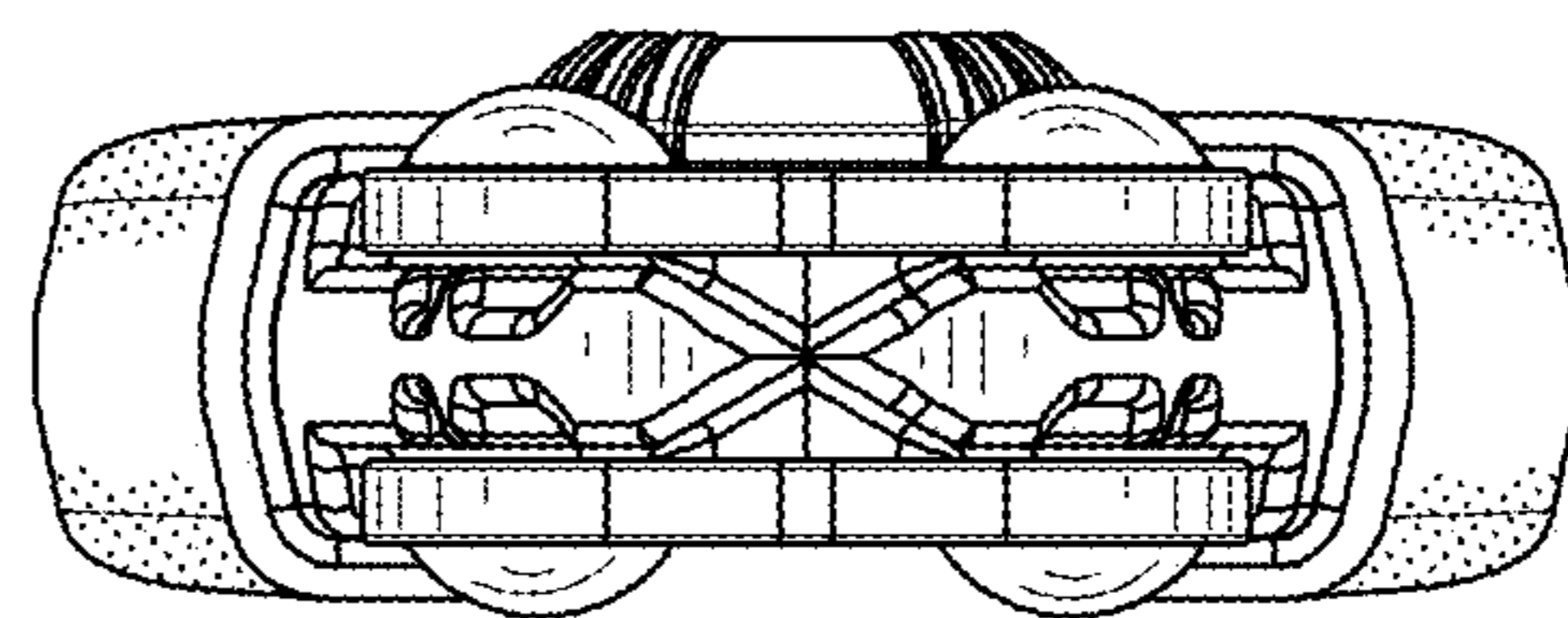

FIG. 7