



US00D968164S

(12) **United States Design Patent** (10) **Patent No.:** **US D968,164 S**  
**Zheng** (45) **Date of Patent:** **\*\* Nov. 1, 2022**

(54) **HONEYCOMB PATTERN CUP** D621,267 S \* 8/2010 Arnell ..... D9/554  
D621,270 S \* 8/2010 Arnell ..... B65D 1/0223  
(71) Applicant: **Fuxi (hangzhou) Intellectual Property management Co., Hangzhou (CN)** D9/554  
D719,033 S \* 12/2014 Kaddari ..... D9/668  
D867,156 S \* 11/2019 Morehead ..... D9/600

(72) Inventor: **Yaoyao Zheng, Hangzhou (CN)**

(73) Assignee: **FUXI (HANGZHOU) INTELLECTUAL PROPERTY MANAGEMENT, Hangzhou (CN)**

(\*\*) Term: **15 Years**

(21) Appl. No.: **29/765,377**

(22) Filed: **Jan. 7, 2021**

(51) **LOC (13) Cl.** ..... **07-01**

(52) **U.S. Cl.**  
USPC ..... **D7/514; D7/511; D7/523; D9/550**

(58) **Field of Classification Search**  
USPC ..... D7/509, 510, 511, 514, 515, 523, 560,  
D7/564, 565, 584, 300, 601, 602, 612,  
D7/613, 615, 630; D9/738, 772, 773,  
D9/537, 538, 541, 559, 600  
CPC ..... A47G 19/22; A47G 19/2205; A47G  
19/2266; A47J 41/00; B65D 1/12; B65D  
81/3837; B65D 1/10

See application file for complete search history.

(56) **References Cited**

**U.S. PATENT DOCUMENTS**

D107,582 S \* 12/1937 Straub ..... D9/600  
D158,213 S \* 4/1950 Nester ..... D9/556  
D193,117 S \* 6/1962 Umasoff ..... D9/557  
D302,790 S \* 8/1989 Roe ..... D9/504  
5,988,417 A \* 11/1999 Cheng ..... B65D 1/0223  
220/675  
D547,666 S \* 7/2007 Hermel ..... D9/520  
D614,039 S \* 4/2010 Arnell ..... D9/554

**OTHER PUBLICATIONS**

Home Basics Canister | posted at Amazon.com, posted on Jul. 29, 2020, © 1996-2022 Amazon.com, [online], [site visited May 6, 2022]. Available from Internet, <https://www.amazon.com/dp/B08DVFCQX7/> (Year: 2020).\*

\* cited by examiner

*Primary Examiner* — Andrew Kerr

(74) *Attorney, Agent, or Firm* — NZ Carr Law Office

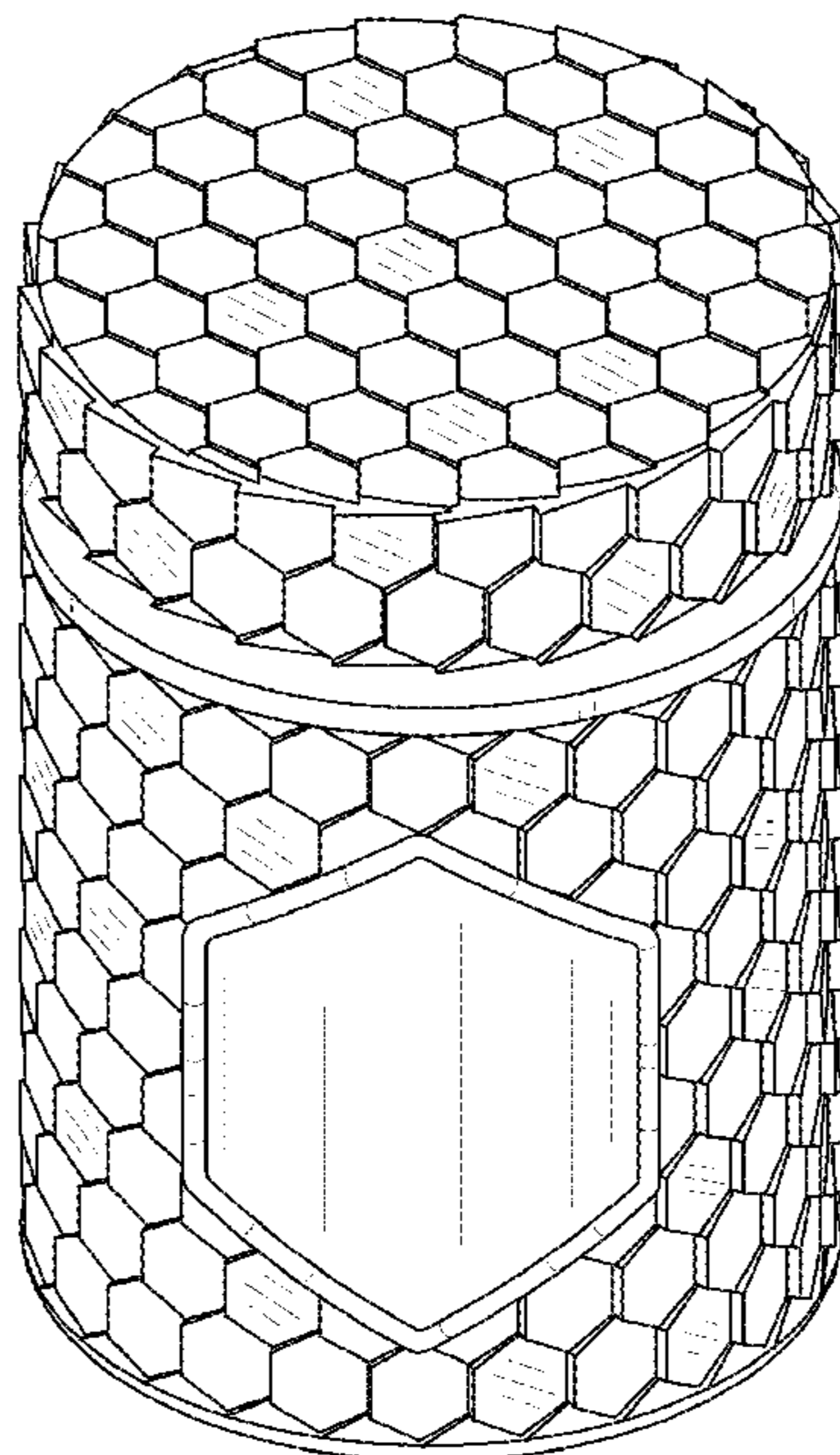
(57) **CLAIM**

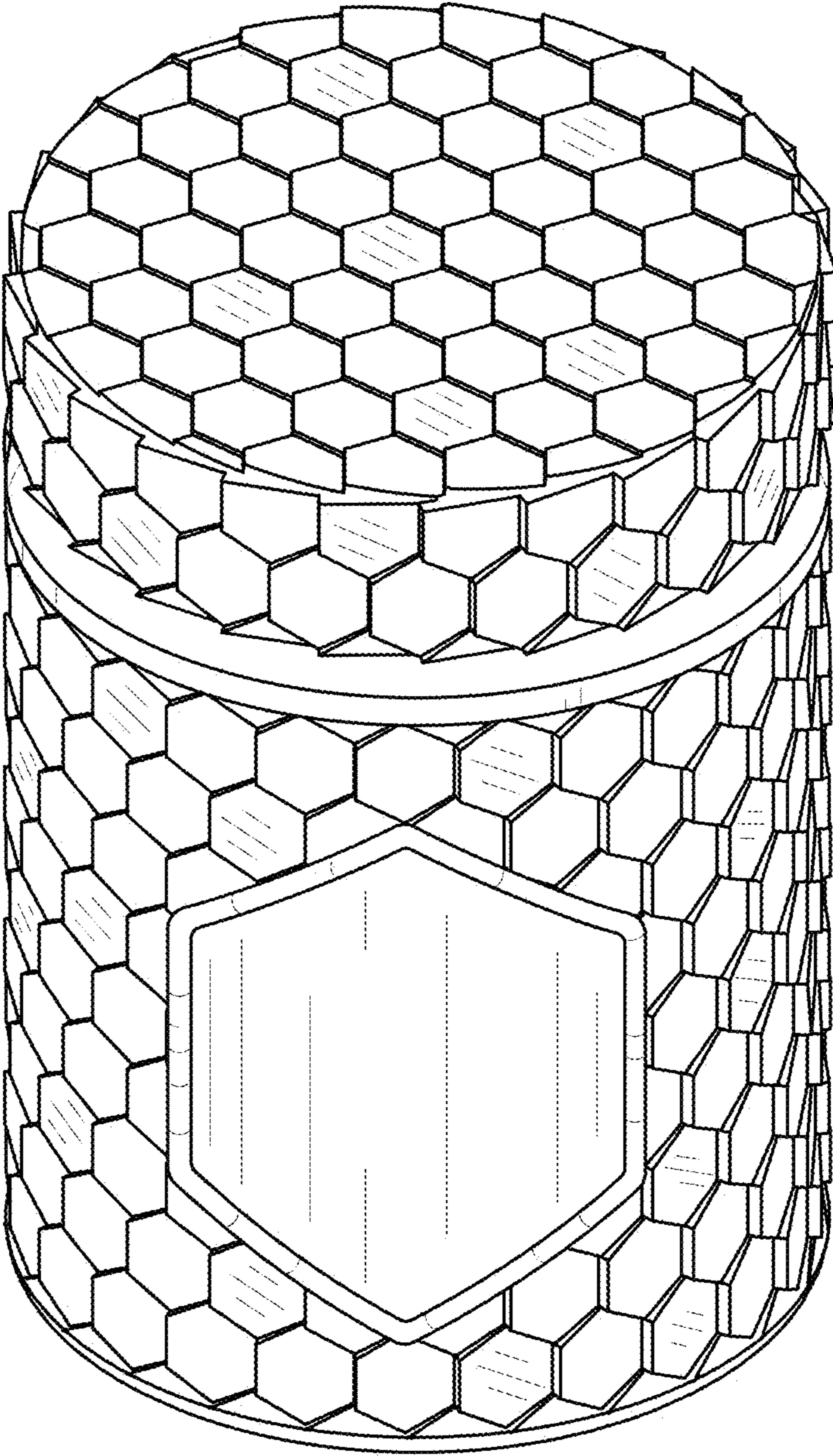
The ornamental design for a honeycomb pattern cup, as shown and described.

**DESCRIPTION**

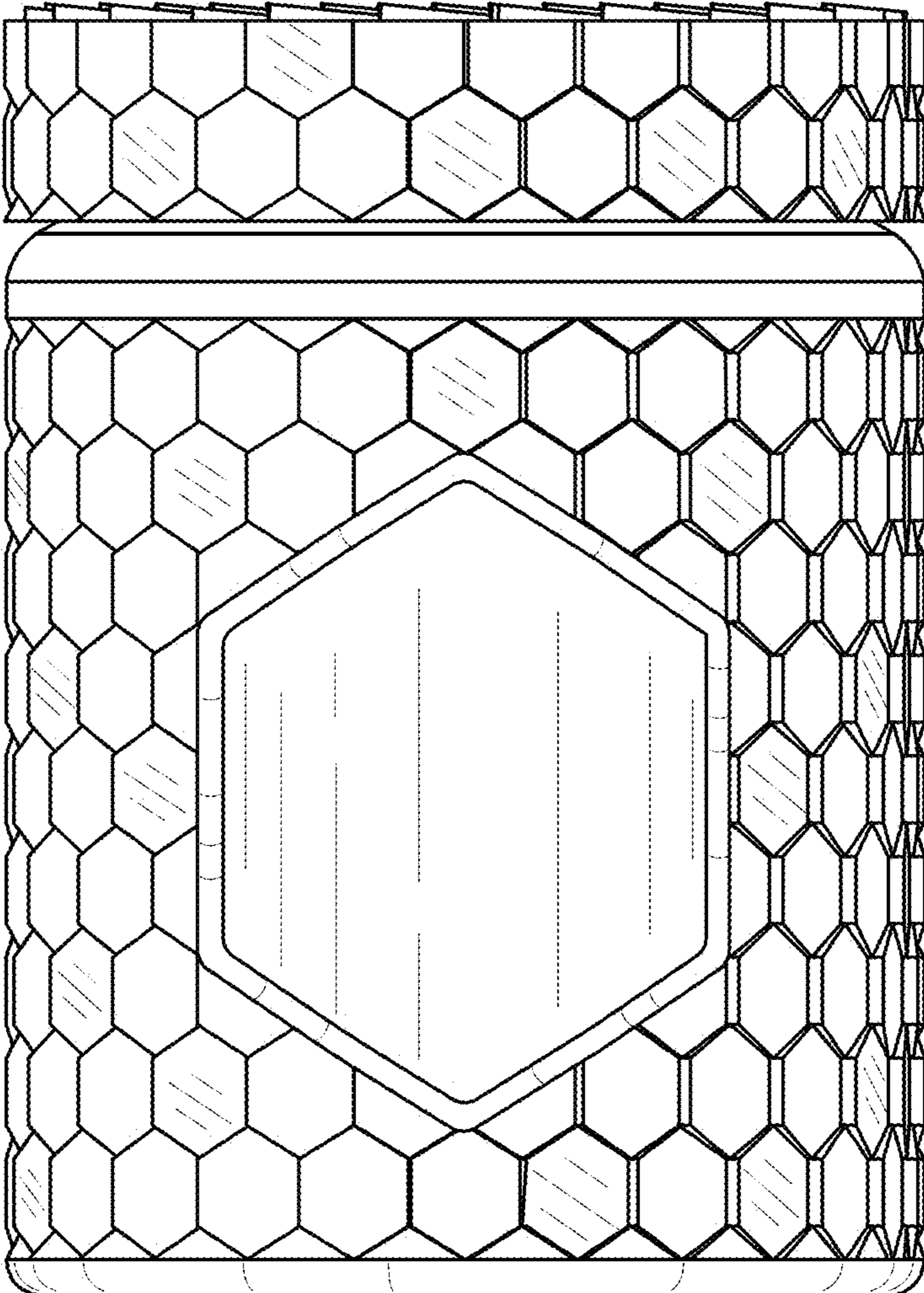
FIG. 1 is a front, top perspective view of a honeycomb pattern cup, showing my new design;  
FIG. 2 is a front view thereof;  
FIG. 3 is a back view thereof;  
FIG. 4 is a left side view thereof;  
FIG. 5 is a right side view thereof;  
FIG. 6 is a perspective view of the honeycomb pattern cup in an open position;  
FIG. 7 is a front view thereof, in an alternate open position;  
FIG. 8 is a top view thereof; and,  
FIG. 9 is a bottom view thereof.  
All broken lines represent portions of the honeycomb pattern cup that form no part of the claimed subject matter.

**1 Claim, 9 Drawing Sheets**

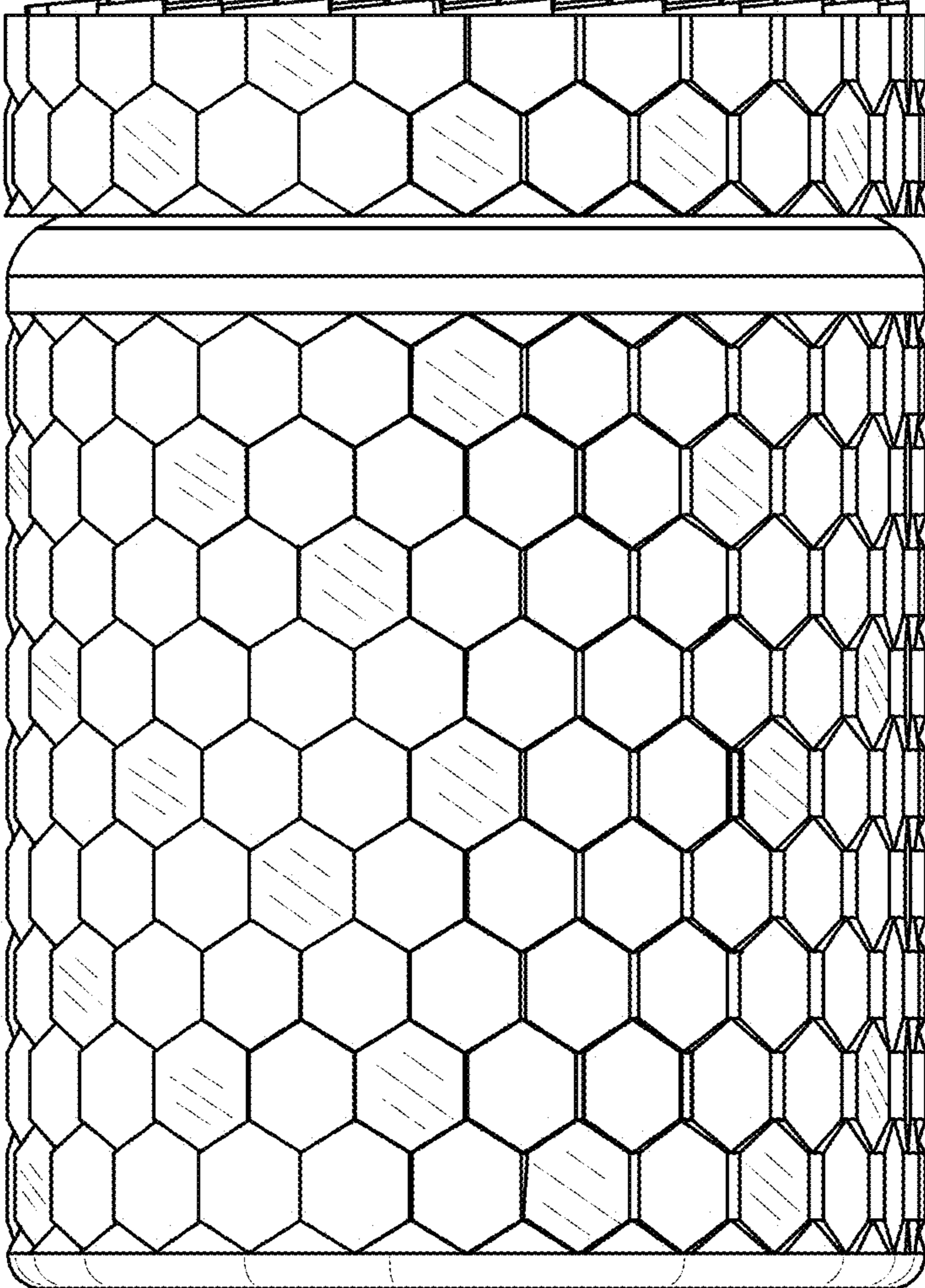




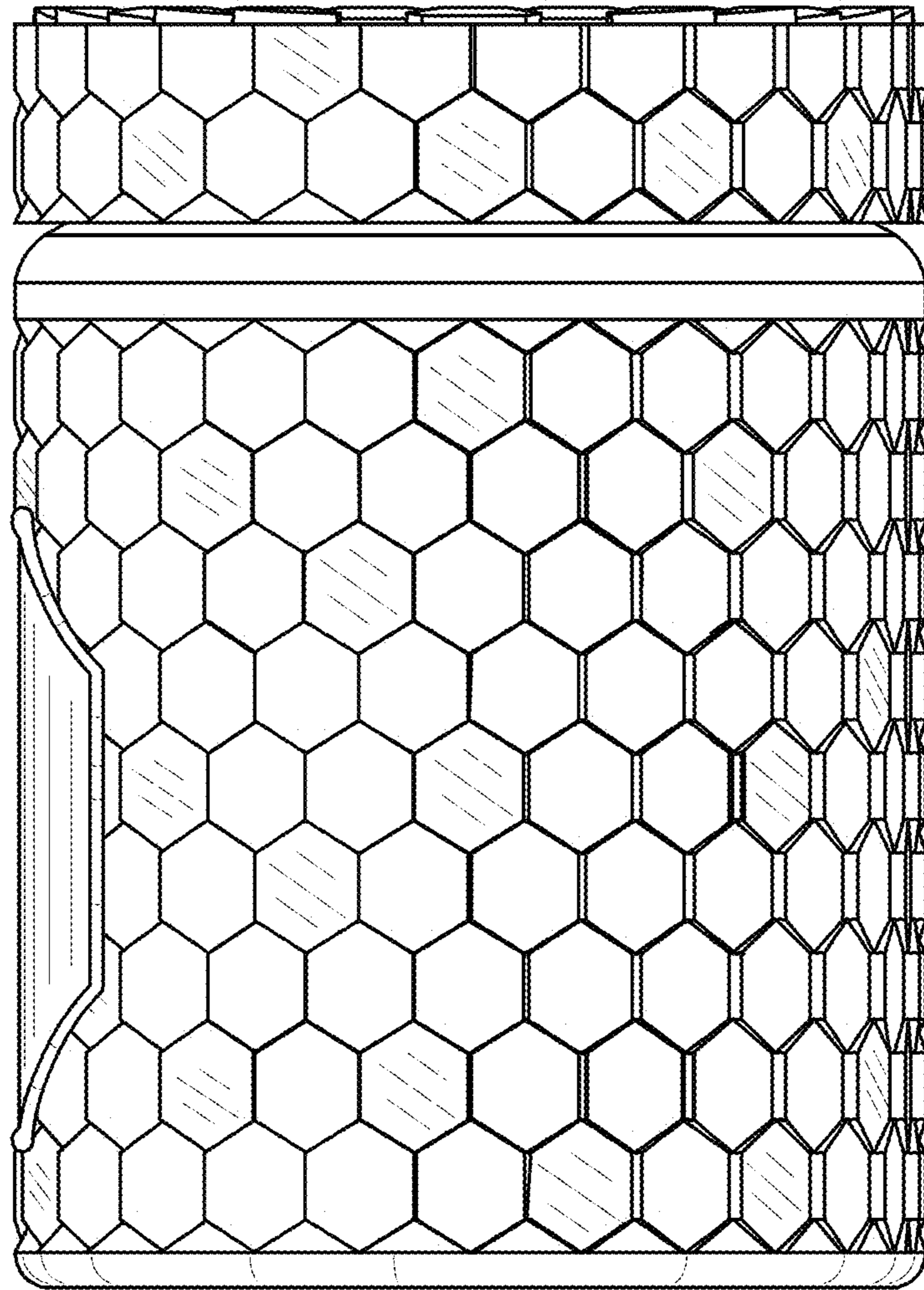
*Fig. 1*



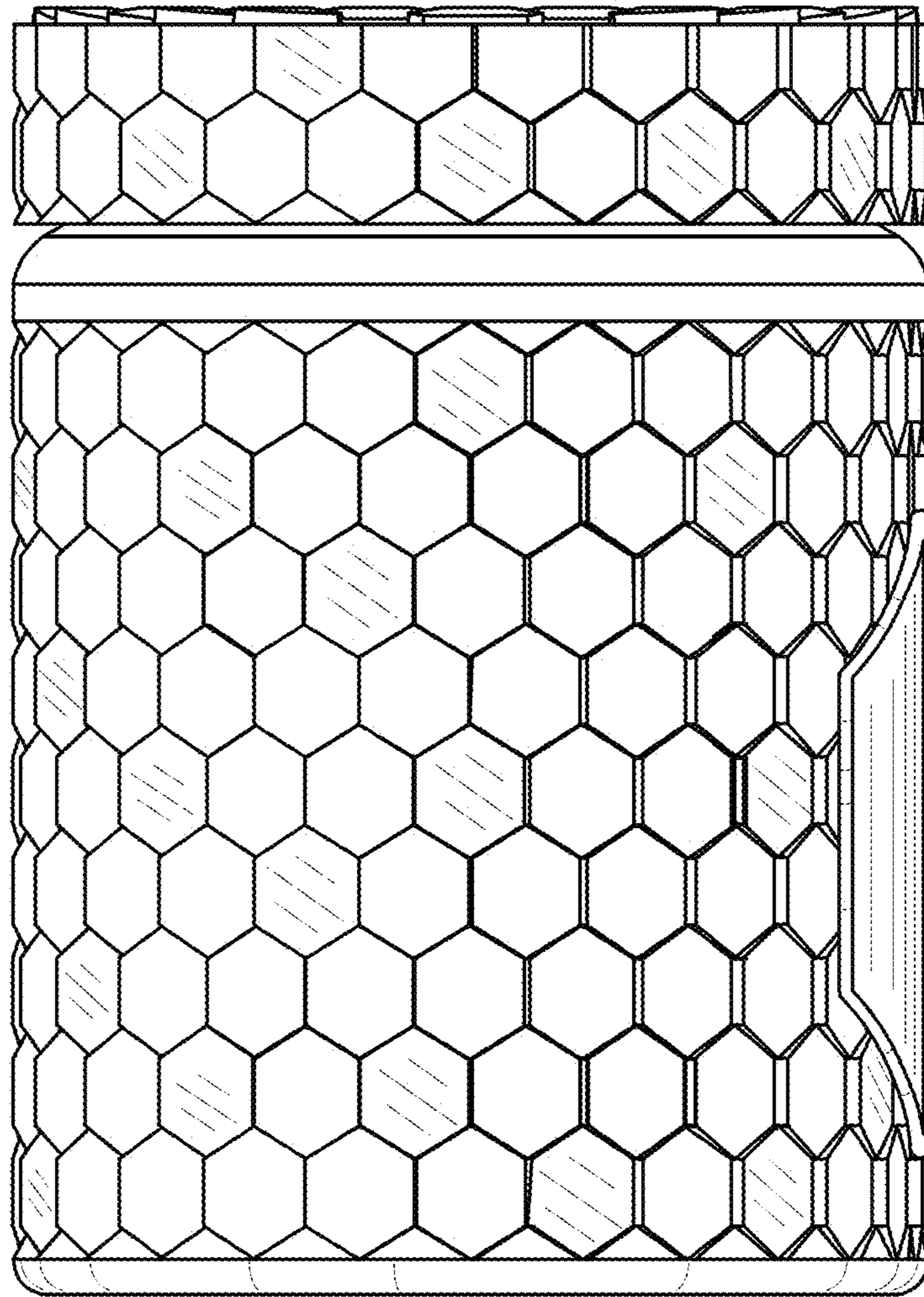
*Fig.2*



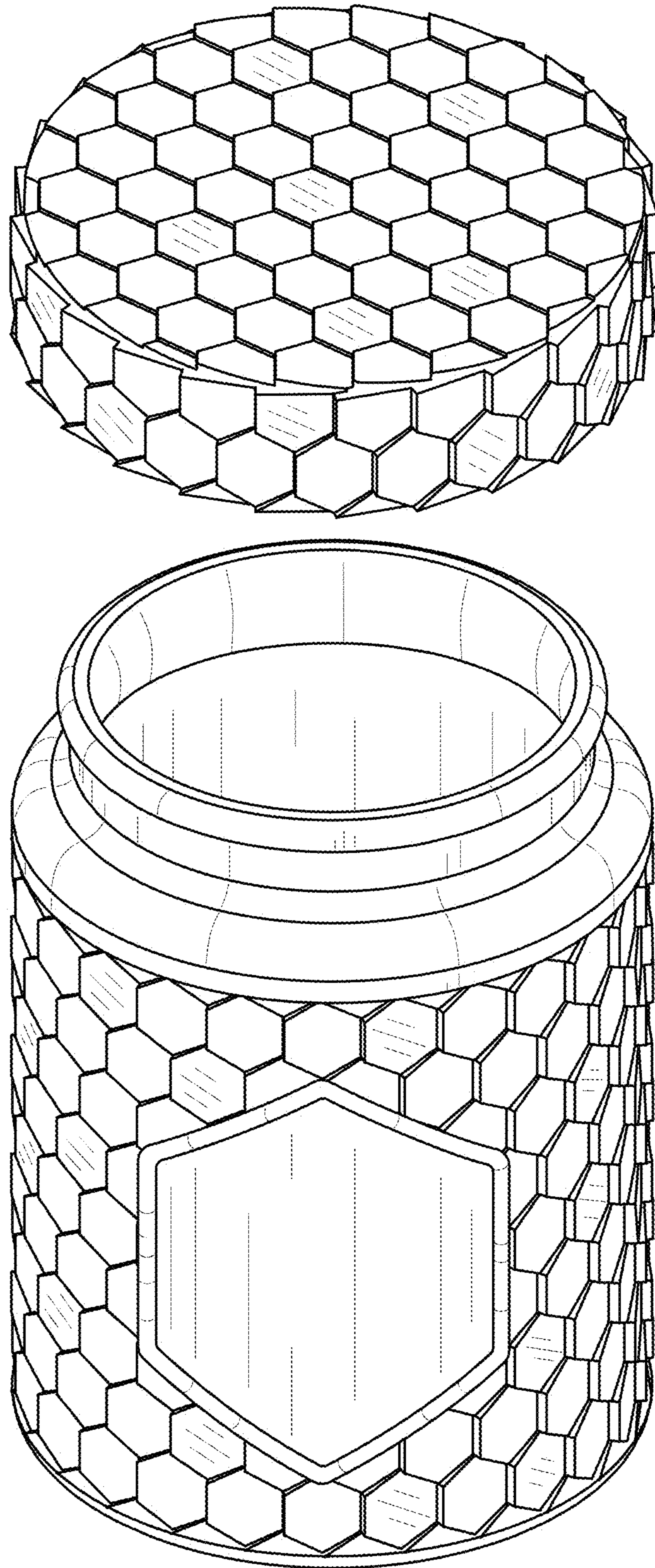
*Fig.3*



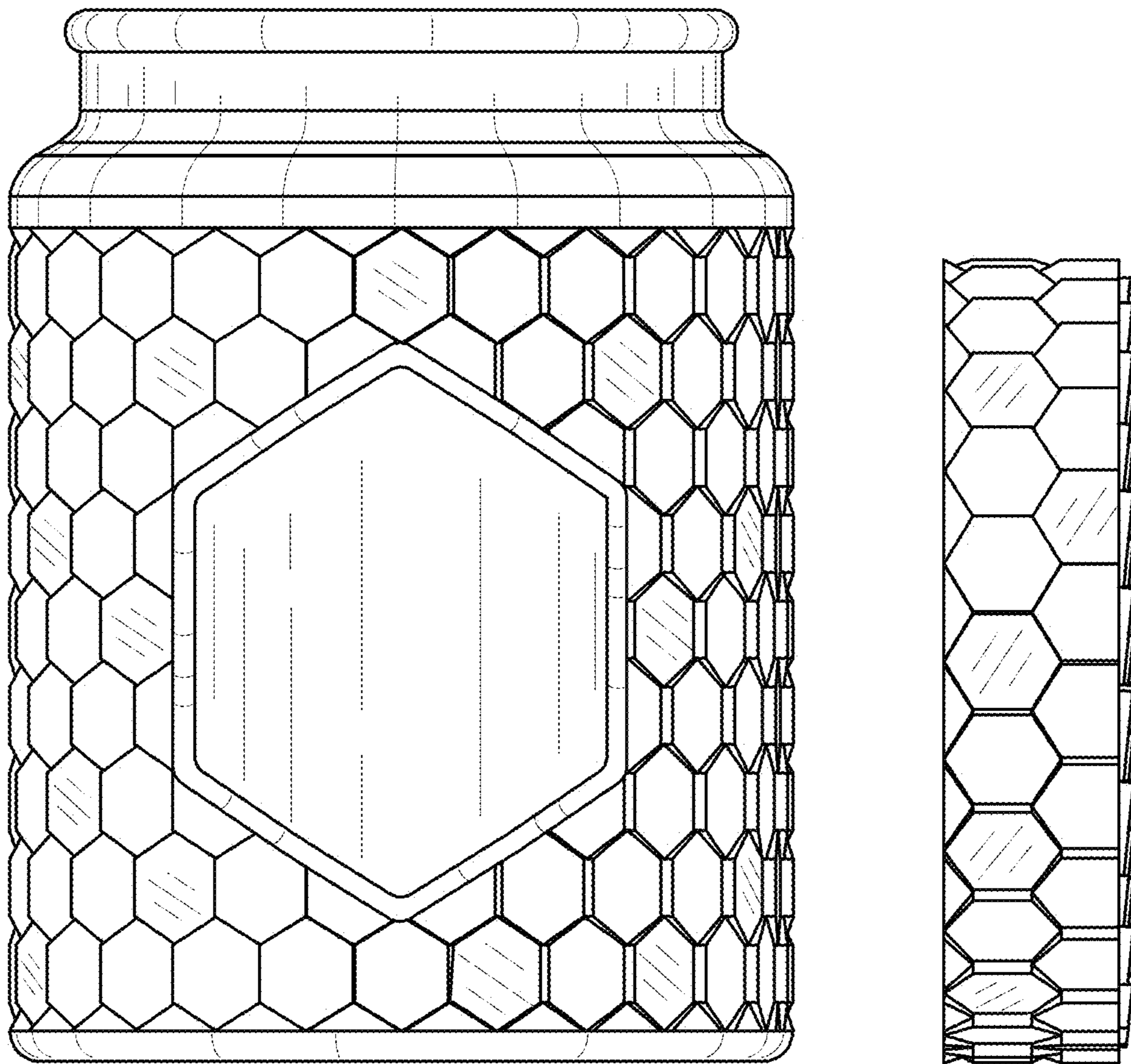
*Fig.4*



*Fig.5*

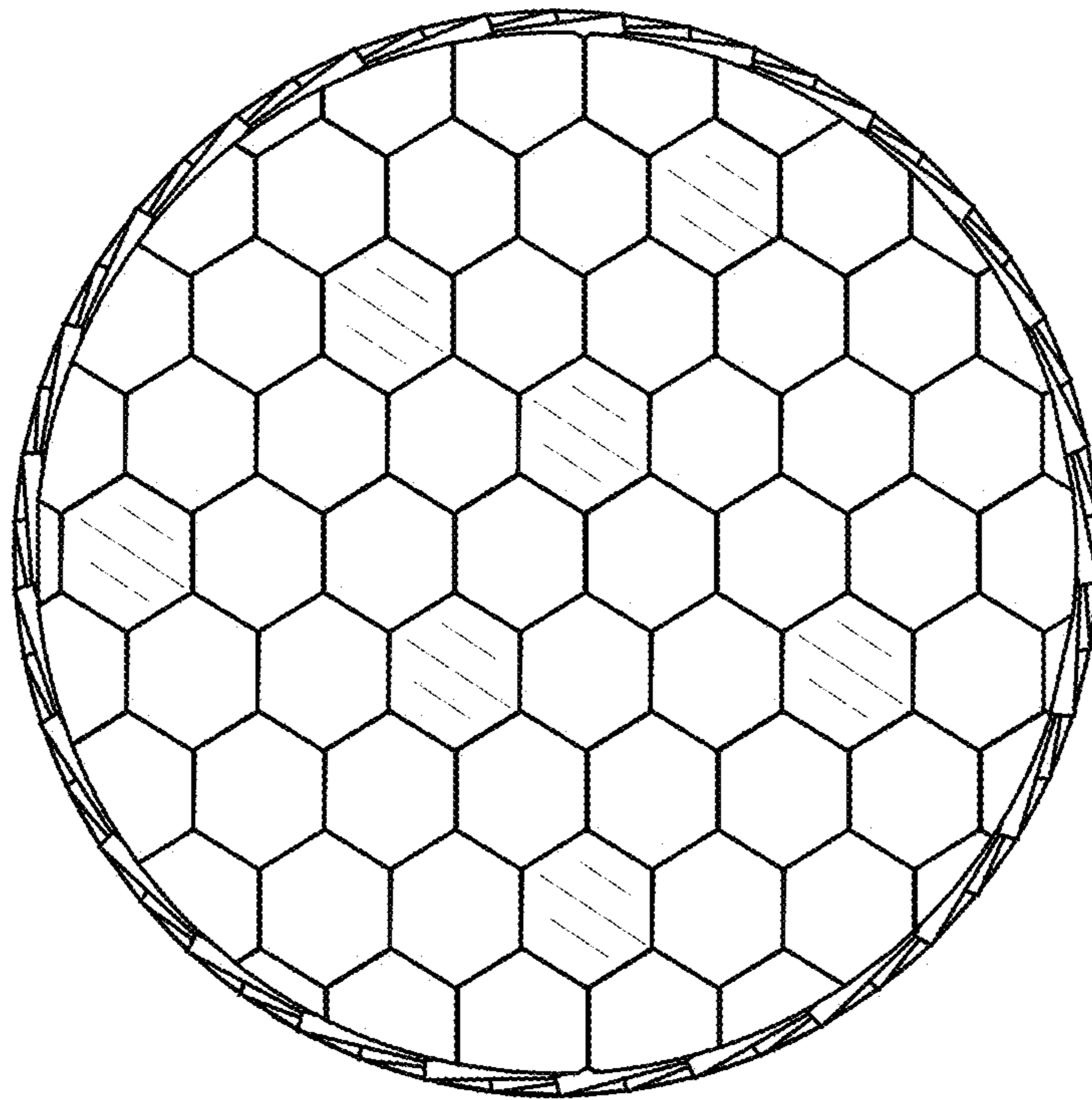


*Fig.6*

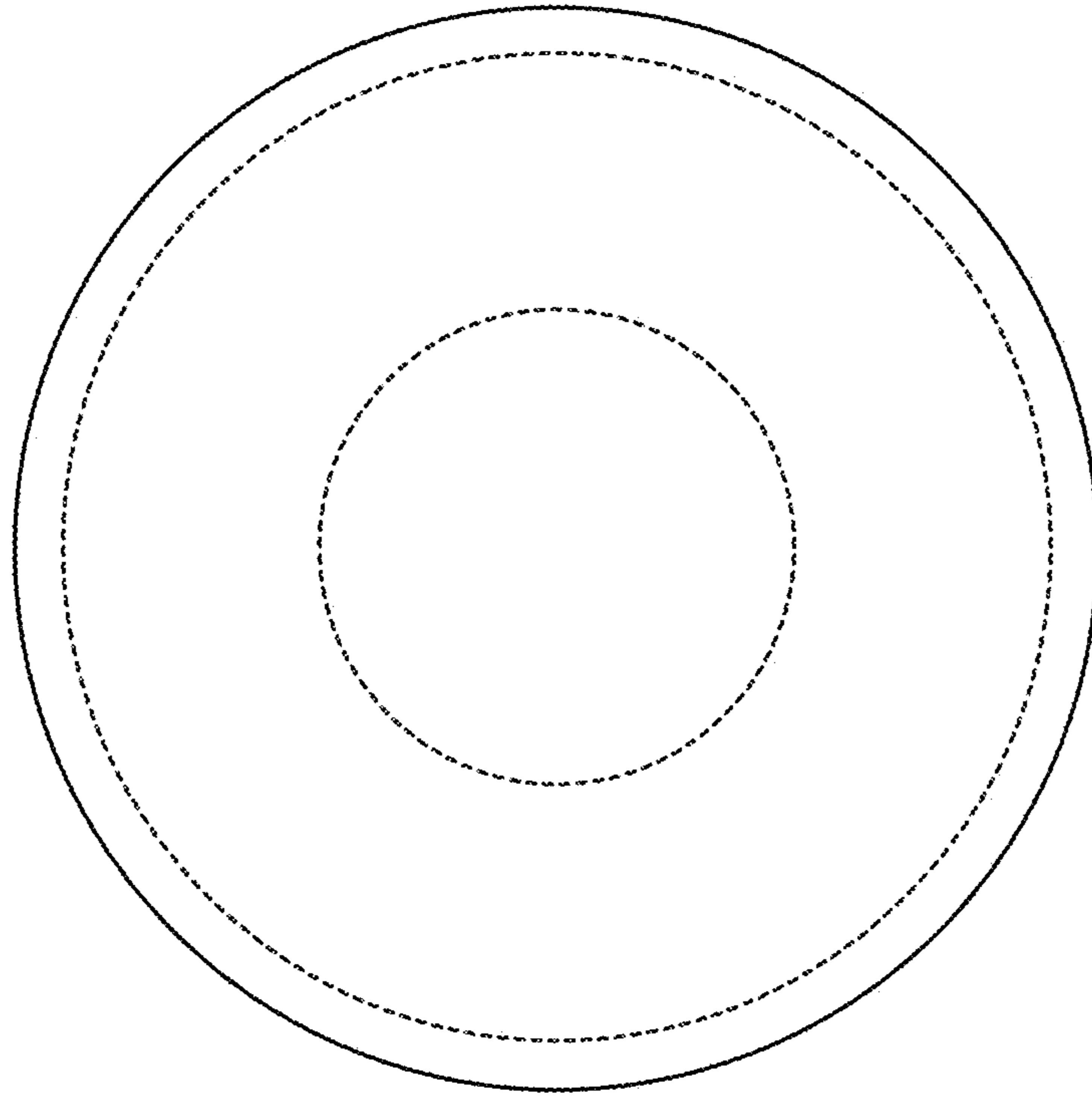


*Fig. 7*





*Fig. 8*



*Fig.9*