



US00D968067S

(12) **United States Design Patent**  
**Makere**

(10) **Patent No.:** **US D968,067 S**  
(45) **Date of Patent:** **\*\* Nov. 1, 2022**

(54) **SHOE**

FOREIGN PATENT DOCUMENTS

(71) Applicant: **Converse Inc.**, Boston, MA (US)

CN 306958529 \* 11/2021

(72) Inventor: **Alyssa Makere**, Boston, MA (US)

OTHER PUBLICATIONS

(73) Assignee: **Converse Inc.**, Boston, MA (US)

The Women's Converse Run Star Motion Releases Tomorrow, announced Jun. 30, 2021 [online], [site visited Feb. 22, 2022]. Available from internet, URL: <https://sneakernews.com/2021/06/30/converse-run-star-motion-womens-release-date/> (Year: 2021).\*

(\*\*) Term: **15 Years**

(Continued)

(21) Appl. No.: **29/761,501**

(22) Filed: **Dec. 9, 2020**

(51) **LOC (13) Cl.** ..... **02-04**

(52) **U.S. Cl.**  
USPC ..... **D2/960; D2/947; D2/951**

(58) **Field of Classification Search**  
USPC ..... D2/902-908, 915, 946-960, 964, 968,  
D2/972, 976, 977

CPC ..... A43B 13/02; A43B 13/04; A43B 13/14;  
A43B 13/26; A43B 1/10; A43B 1/12;  
A43B 1/14; A43B 21/06; A43B 21/24

See application file for complete search history.

*Primary Examiner* — Elizabeth J Oswecki  
*Assistant Examiner* — Yelizaveta Y Masalimova  
(74) *Attorney, Agent, or Firm* — Banner & Witcoff, Ltd.

(56) **References Cited**

U.S. PATENT DOCUMENTS

D268,299 S *	3/1983	Argyropoulos	.....	D2/960
D273,437 S *	4/1984	Kohno	.....	D2/908
D301,798 S *	6/1989	Jonah	.....	D2/908
D301,934 S *	7/1989	Simonin	.....	D2/900
D367,554 S *	3/1996	James	.....	D2/912
D485,976 S *	2/2004	Maatita	.....	D2/973
D692,217 S	10/2013	Fogg		
D713,625 S *	9/2014	Raasch	.....	D2/947
D798,566 S *	10/2017	Pauk	.....	D2/972
D802,286 S *	11/2017	Klein	.....	D2/972
D845,601 S *	4/2019	Cooper	.....	D2/947
D848,713 S	5/2019	Blauer		
D873,547 S	1/2020	Rauner et al.		
D874,105 S	2/2020	Rauner et al.		
D874,106 S	2/2020	Rauner et al.		
D880,135 S	4/2020	Rauner		
D882,918 S *	5/2020	Kosenick	.....	D2/947

(Continued)

(57) **CLAIM**

The ornamental design for a shoe, as shown and described.

**DESCRIPTION**

FIG. 1 is a rear perspective view of a shoe showing my new design;  
FIG. 2 is a side view thereof;  
FIG. 3 is a rear view thereof;  
FIG. 4 is an opposite side view thereof;  
FIG. 5 is an opposite side rear perspective view thereof;  
FIG. 6 is a bottom rear perspective view thereof;  
FIG. 7 is a bottom view thereof; and,  
FIG. 8 is a bottom front perspective view thereof.  
The broken lines immediately adjacent to the front ends of the shaded area define the bounds of the claimed design and form no part thereof. The broken lines forming a star-shaped region within the shaded area, and the unshaded area therein, form no part of the claimed design. The broken lines depicting the remainder of the shoe form no part of the claimed design.

**1 Claim, 8 Drawing Sheets**

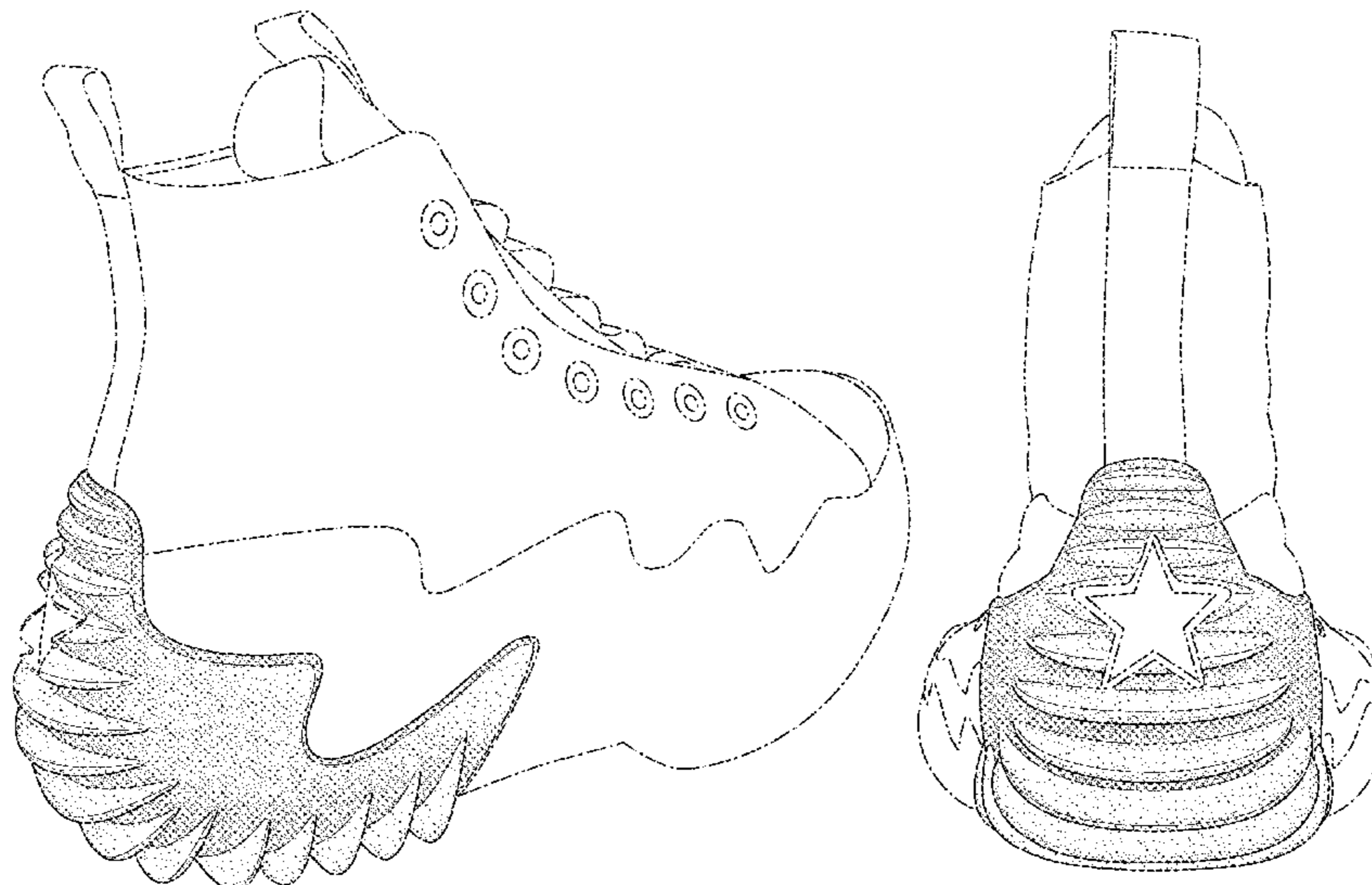

(56)

**References Cited**

U.S. PATENT DOCUMENTS

D928,495 S \* 8/2021 Hannah ..... D2/972  
D948,850 S \* 4/2022 Small ..... D2/951  
2010/0287793 A1\* 11/2010 Hall ..... A43B 5/0401  
36/114

OTHER PUBLICATIONS

“Run Star Hike”; Converse; retrieved Nov. 11, 2020; published date unknown, but prior to application filing date; URL: <[https://www.converse.com/shop/p/run-star-hike-unisex-high-top-shoe/166800C\\_075.html](https://www.converse.com/shop/p/run-star-hike-unisex-high-top-shoe/166800C_075.html)>.

“VSL Sneaker Review: Converse Run Star Hike”; Versa Style LAB; retrieved Nov. 11, 2020; published May 27, 2020; URL: <<https://versastylelab.com/2020/05/27/vsl-sneaker-review-converse-run-star-hike/>>.

\* cited by examiner

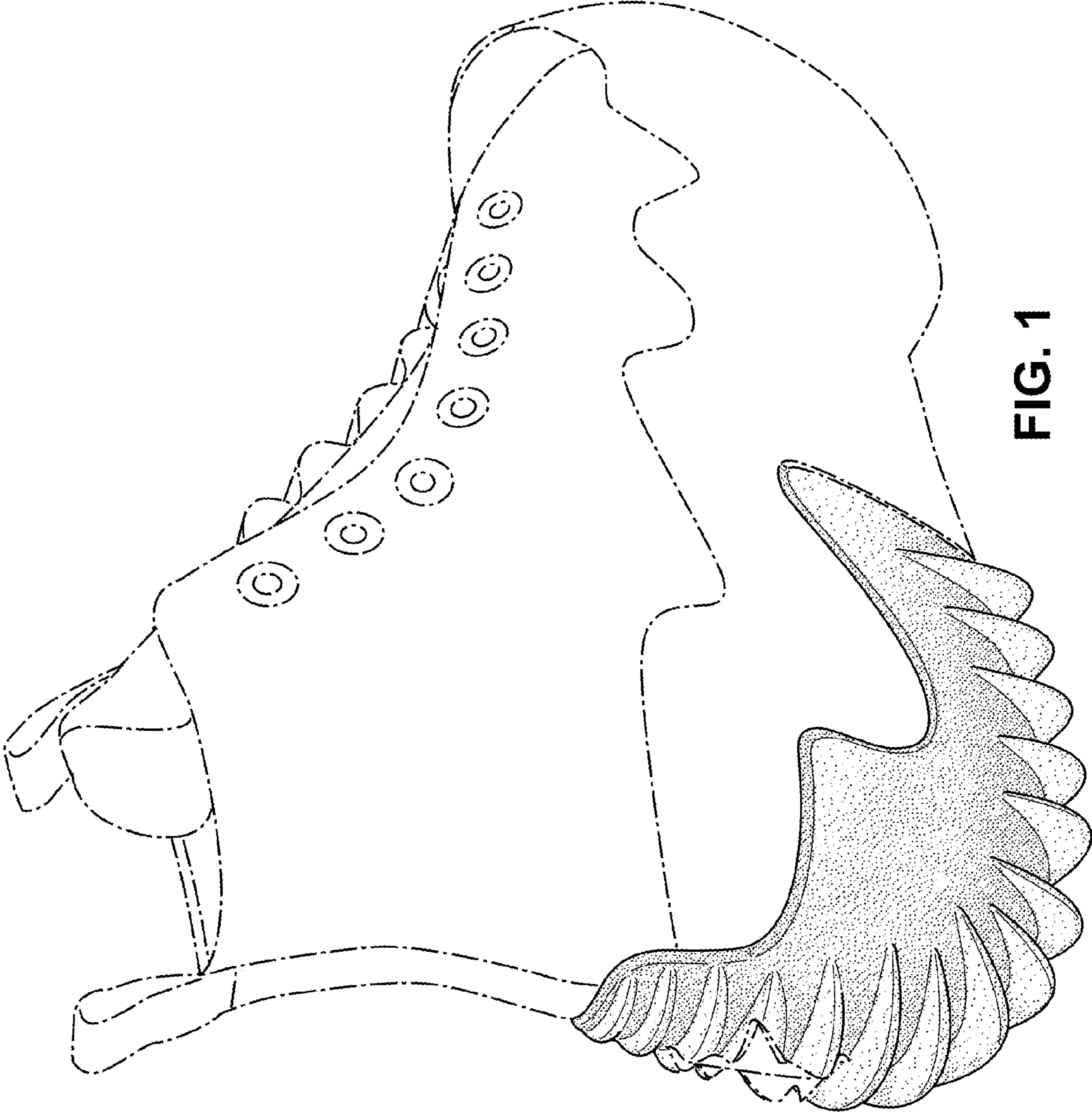

FIG. 1



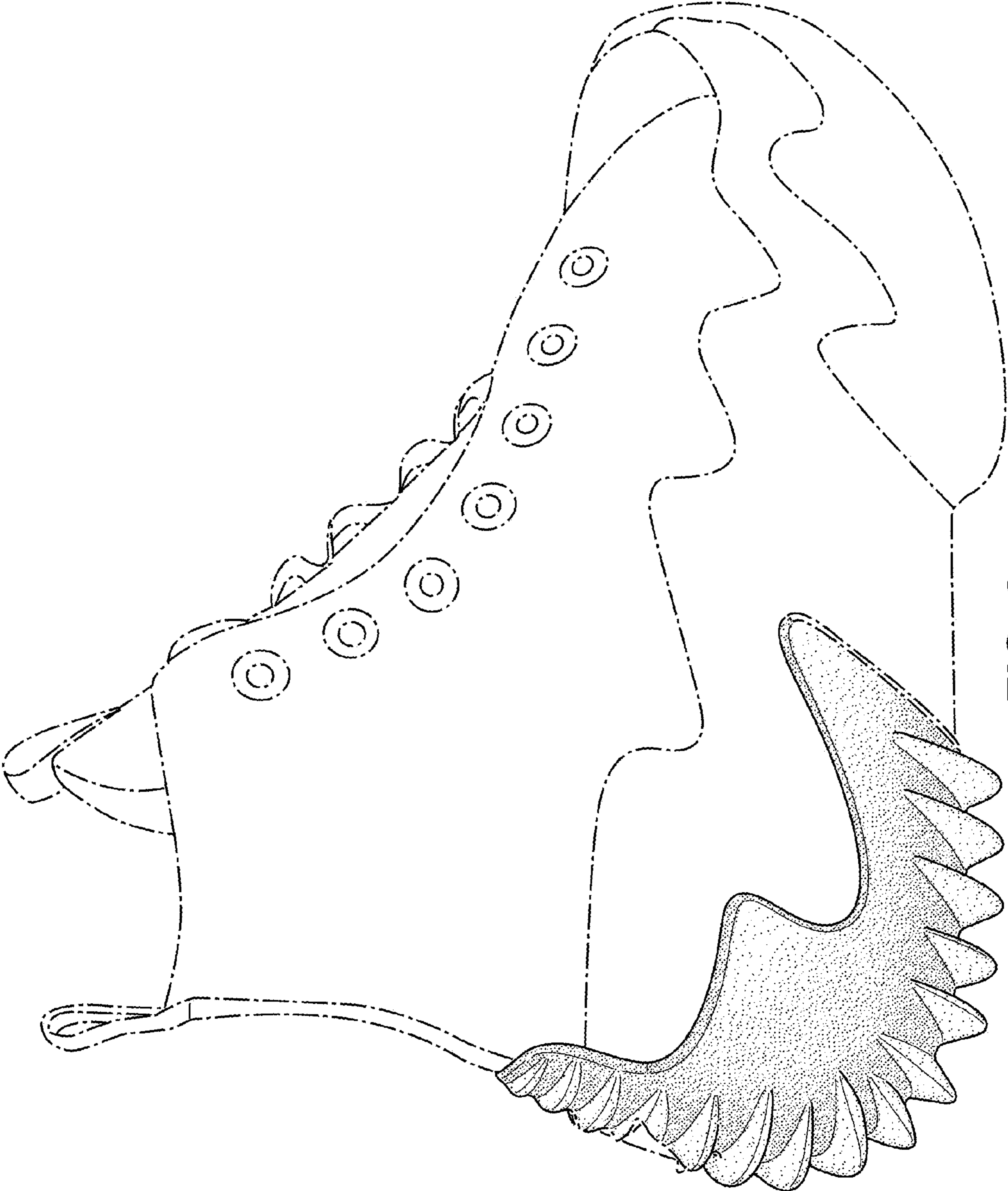

FIG. 2

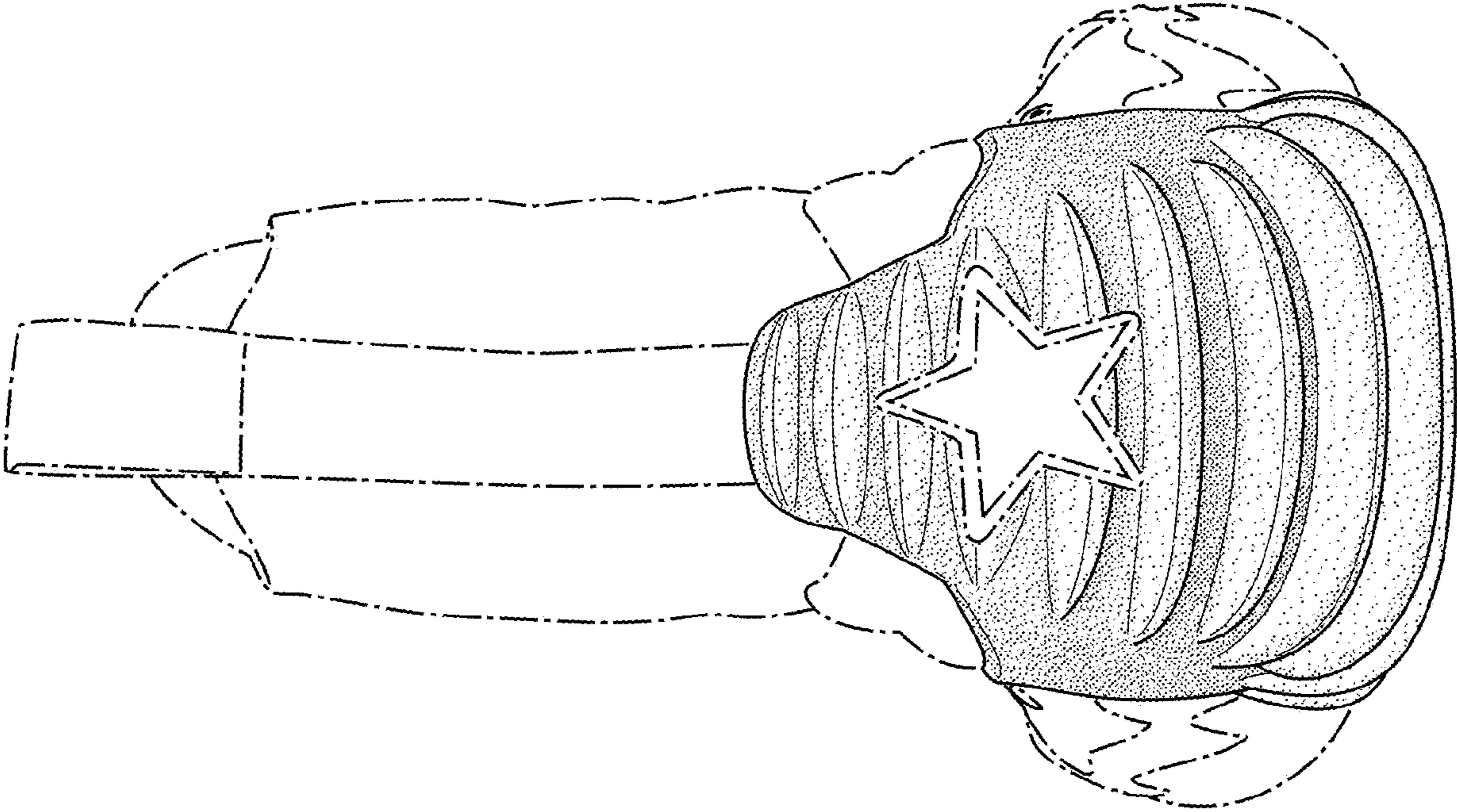

FIG. 3

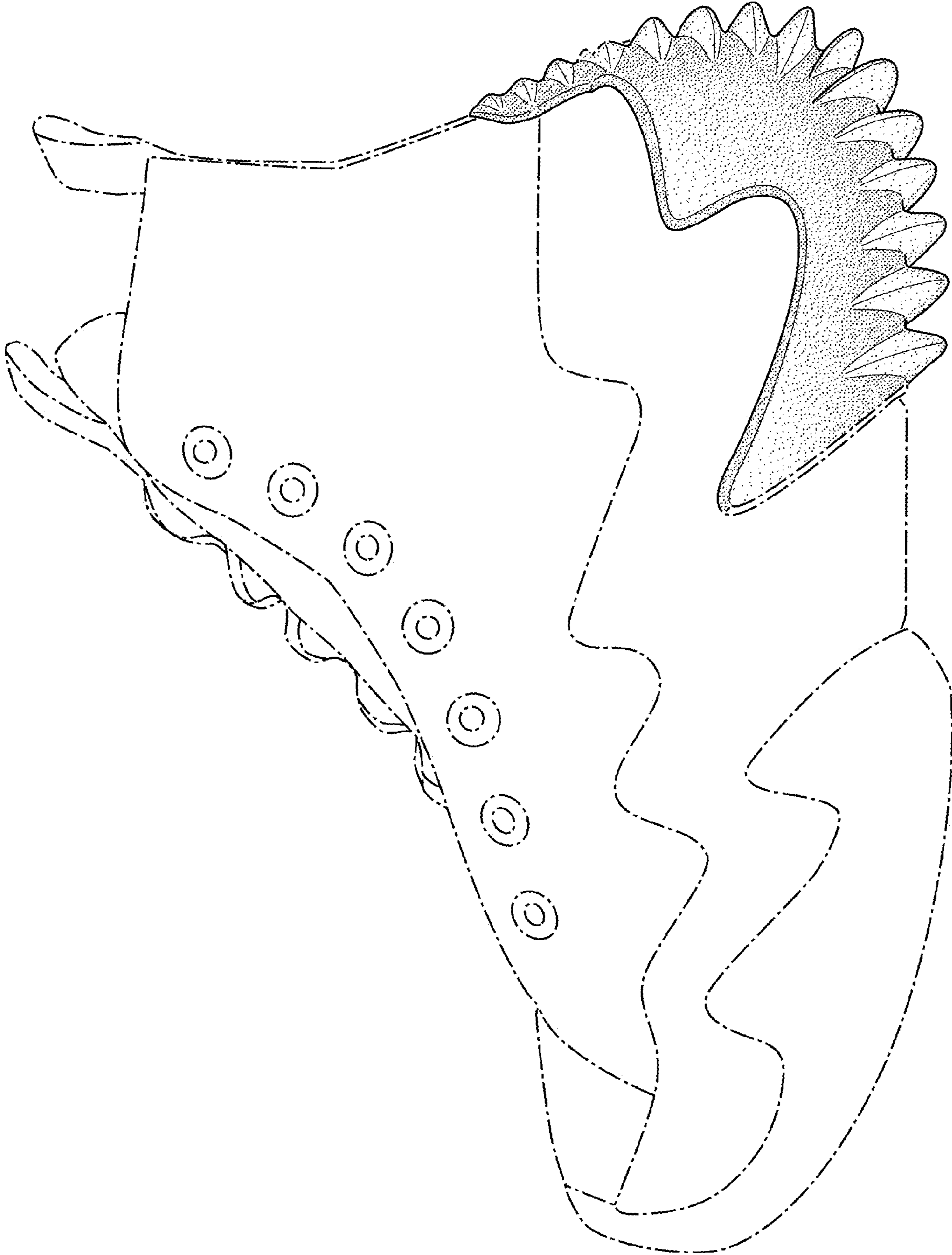

FIG. 4

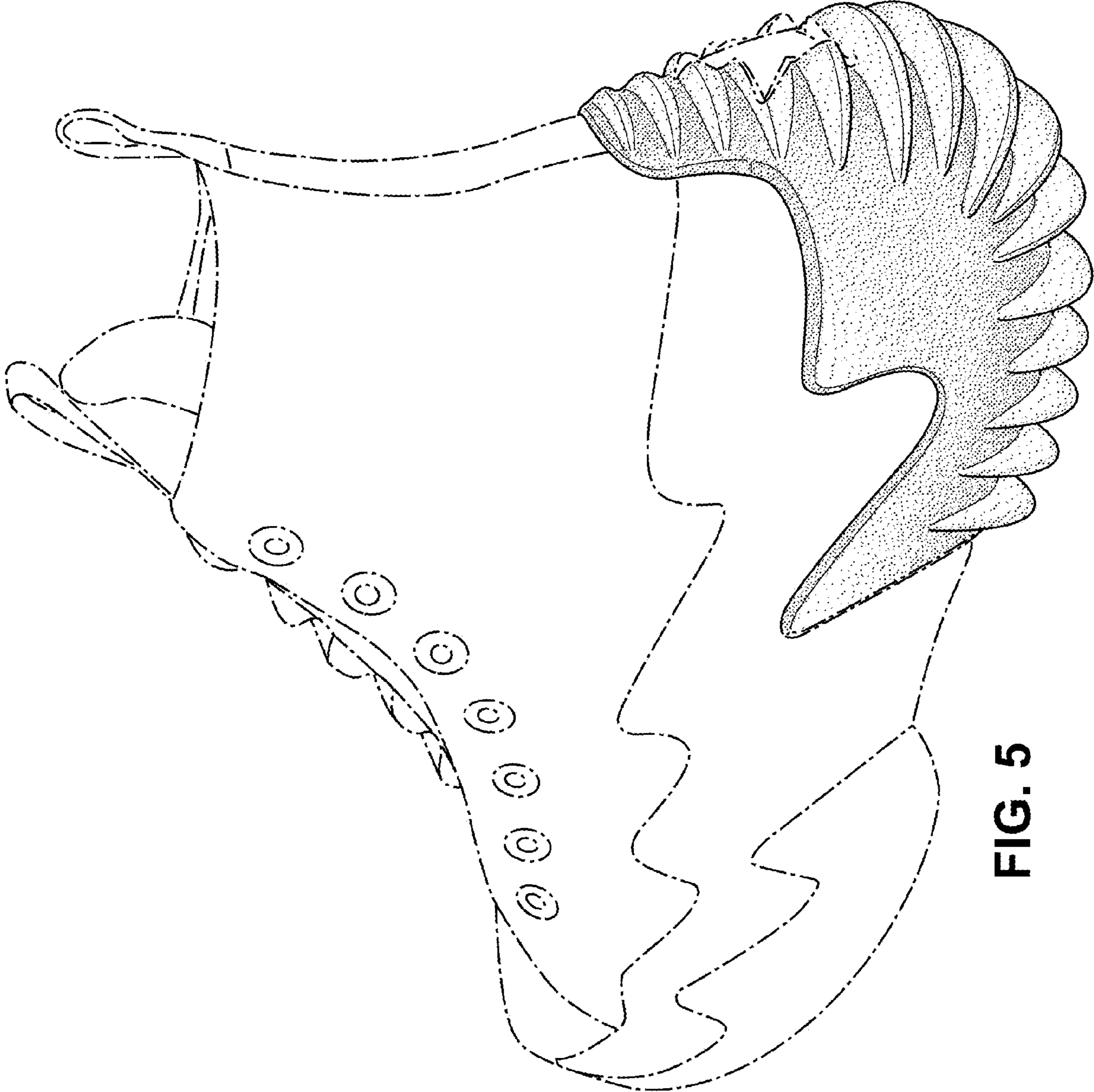

FIG. 5



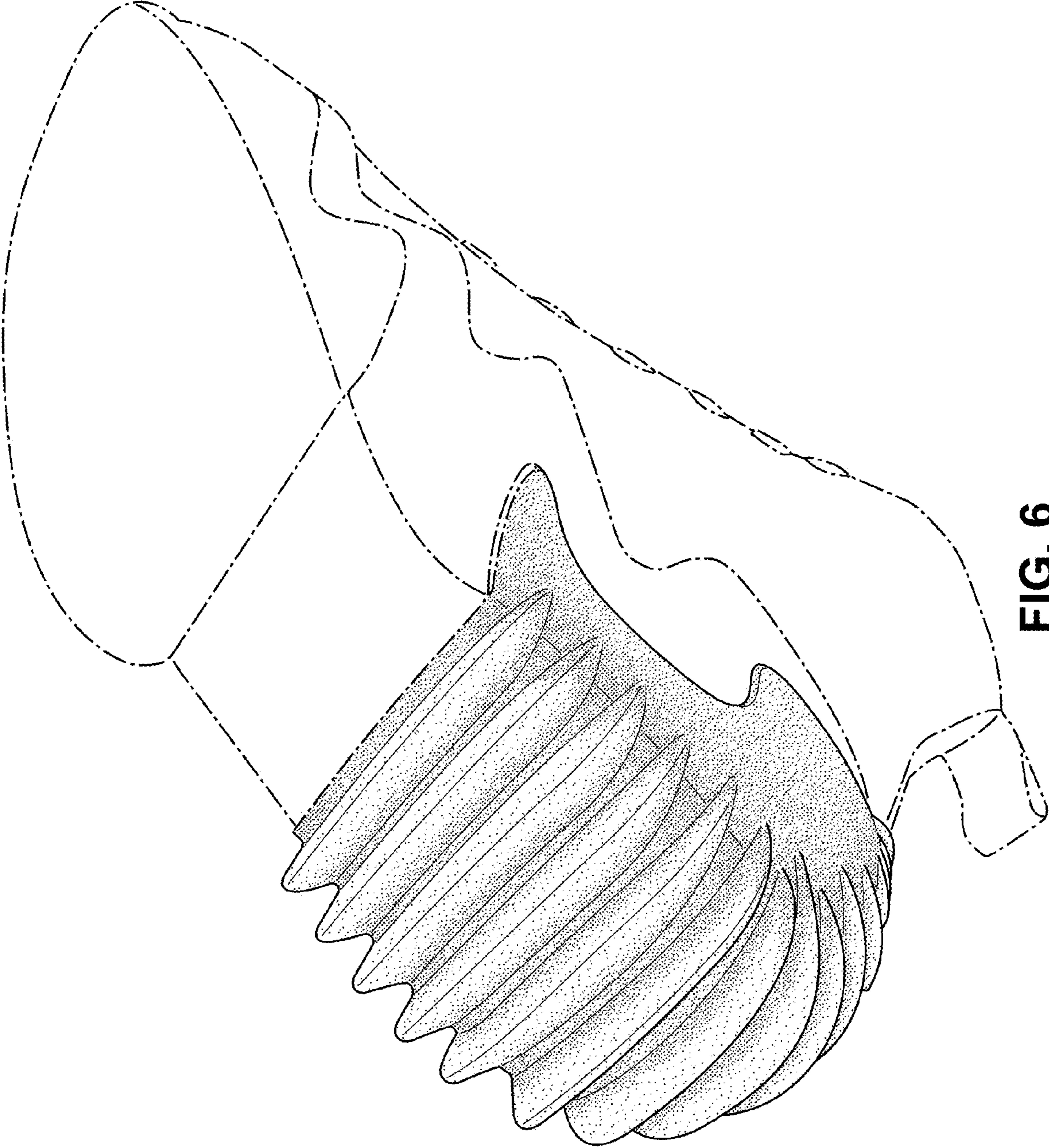

FIG. 6



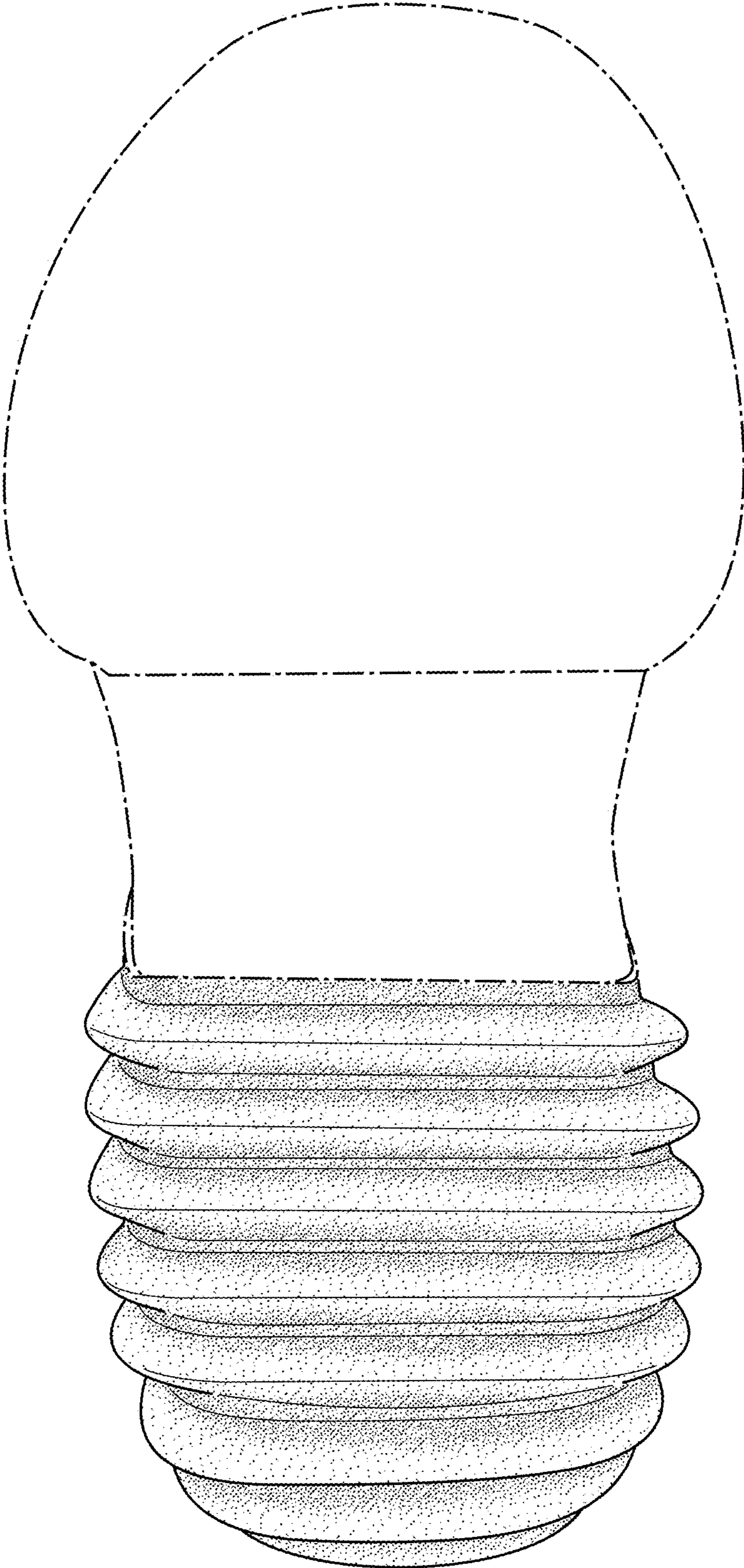

FIG. 7

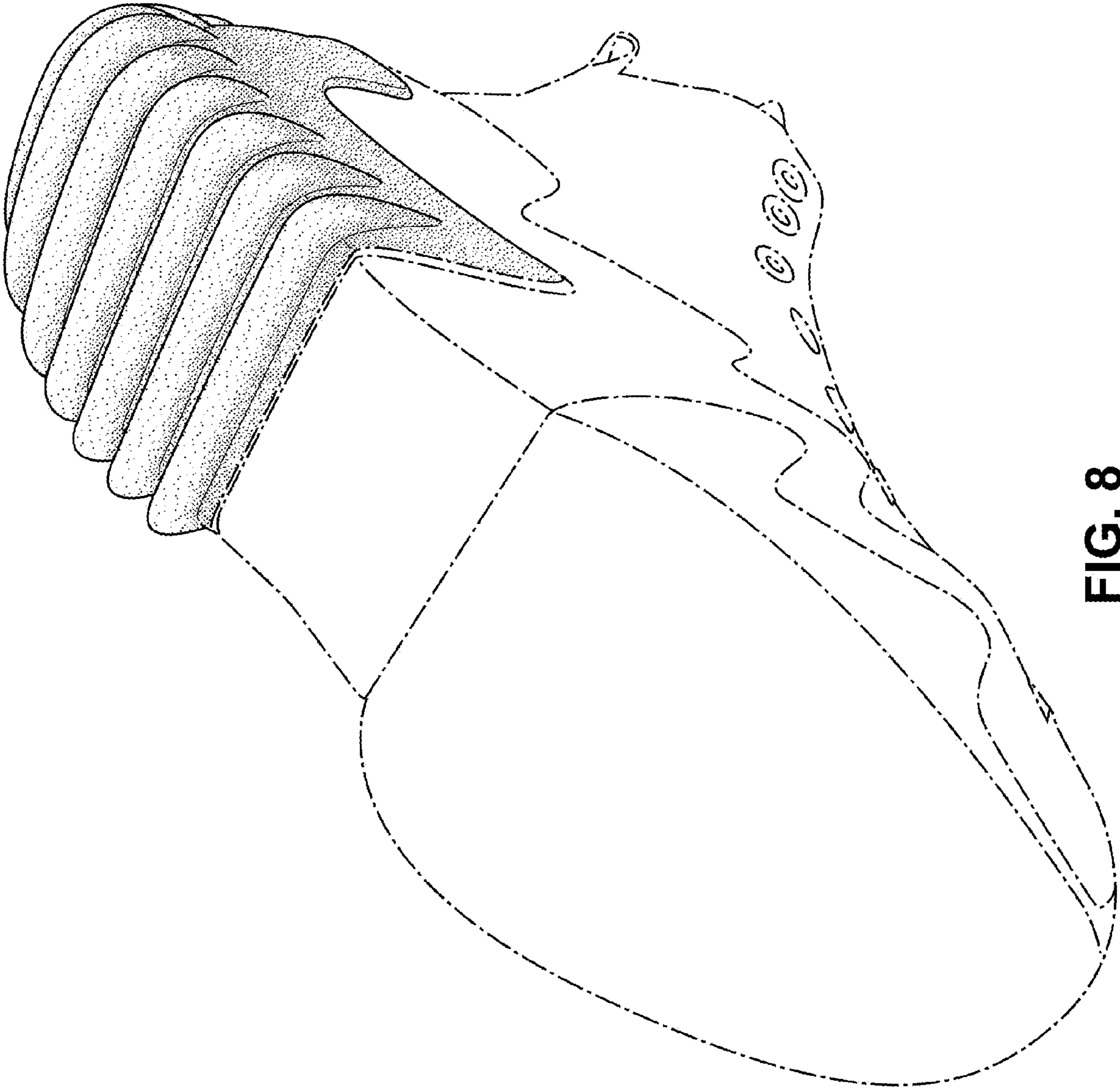

FIG. 8