

US00D968050S

(12) **United States Design Patent** (10) **Patent No.:** **US D968,050 S**
Speciale et al. (45) **Date of Patent:** **** *Nov. 1, 2022**

(54) **WHOLE BODY WEARABLE BLANKET**

(71) Applicant: **Cozy Comfort Company LLC**,
Pleasanton, CA (US)

(72) Inventors: **Brian Speciale**, Cave Creek, AZ (US);
Michael Speciale, Phoenix, AZ (US)

(*) Notice: This patent is subject to a terminal disclaimer.

(**) Term: **15 Years**

(21) Appl. No.: **29/767,561**

(22) Filed: **Jan. 23, 2021**

D105,075 S	6/1937	Richards
D105,681 S	8/1937	Zimmerman
D106,949 S	11/1937	Rosenblatt
D108,039 S	1/1938	Silvermaii
2,126,186 A	8/1938	Friedland
D117,438 S	10/1939	Yanofsky
D121,044 S	6/1940	Berkman
D128,543 S	7/1941	Manna
D132,340 S	5/1942	Schwartz
D139,136 S	10/1944	Gerstman
D139,535 S	11/1944	Bauer
2,613,360 A	10/1952	Friedland et al.
2,967,306 A	1/1961	Fabanich
3,837,006 A	9/1974	Laseman
4,078,264 A	3/1978	DeGennaro et al.
D261,070 S	10/1981	Pettibone
4,347,629 A	9/1982	Itoi
D266,880 S	11/1982	Luhtala
D273,910 S	5/1984	Teeny
D277,049 S	1/1985	Peysen
4,535,479 A	8/1985	Paula
D294,535 S	3/1988	Stricklin
D296,605 S	7/1988	Asher
D298,680 S	11/1988	Chou
4,791,681 A	12/1988	Dean
D300,280 S	3/1989	Gurrola
4,937,883 A	7/1990	Shirai
D338,773 S	8/1993	Wilde
5,611,083 A	3/1997	Arnold
D385,088 S	10/1997	Handysides
D385,688 S	11/1997	Clausell
5,697,102 A	12/1997	Benjamin
D390,337 S	2/1998	Mixon
D430,721 S	9/2000	Beauchan
D433,787 S	11/2000	Bellon
6,185,743 B1	2/2001	Mick
D439,029 S	3/2001	Goldman
6,219,847 B1	4/2001	Aikins
D456,114 S	4/2002	Pyle et al.
6,397,395 B1	6/2002	DeHart
D477,126 S	7/2003	Dunning et al.
D479,902 S	9/2003	Brown
D482,244 S	11/2003	Yamane
6,643,870 B2	11/2003	Bertrand
6,839,911 B1	1/2005	Mathews
D504,800 S	5/2005	Garcia
D512,204 S	12/2005	Thomas et al.
D518,990 S	4/2006	Brogden et al.
D539,508 S	4/2007	Rogers et al.
D539,509 S	4/2007	Fugazzi
D541,011 S	4/2007	Day et al.
D543,011 S	5/2007	Waite
D551,429 S	9/2007	Wager

Related U.S. Application Data

(63) Continuation-in-part of application No. 29/731,086, filed on Apr. 11, 2020, which is a continuation-in-part of application No. 29/705,878, filed on Sep. 16, 2019, now Pat. No. Des. 903,237, which is a continuation-in-part of application No. 29/645,978, filed on Apr. 30, 2018, now Pat. No. Des. 886,416, and a continuation-in-part of application No. 29/617,421, filed on Sep. 13, 2017, now Pat. No. Des. 859,788.

(51) **LOC (13) Cl.** **02-02**

(52) **U.S. Cl.**
USPC **D2/828**

(58) **Field of Classification Search**
USPC D2/828, 830-831, 734, 750
CPC A41D 3/00; A41D 3/08; A41D 7/008
See application file for complete search history.

(56) **References Cited**

U.S. PATENT DOCUMENTS

323,506 A	8/1885	Gates
414,199 A	11/1889	Eighmie
665,624 A	1/1901	Wyman
690,156 A	12/1901	Lamwers
D41,930 S	11/1911	Kingsbtttry
1,739,433 A	12/1929	Young

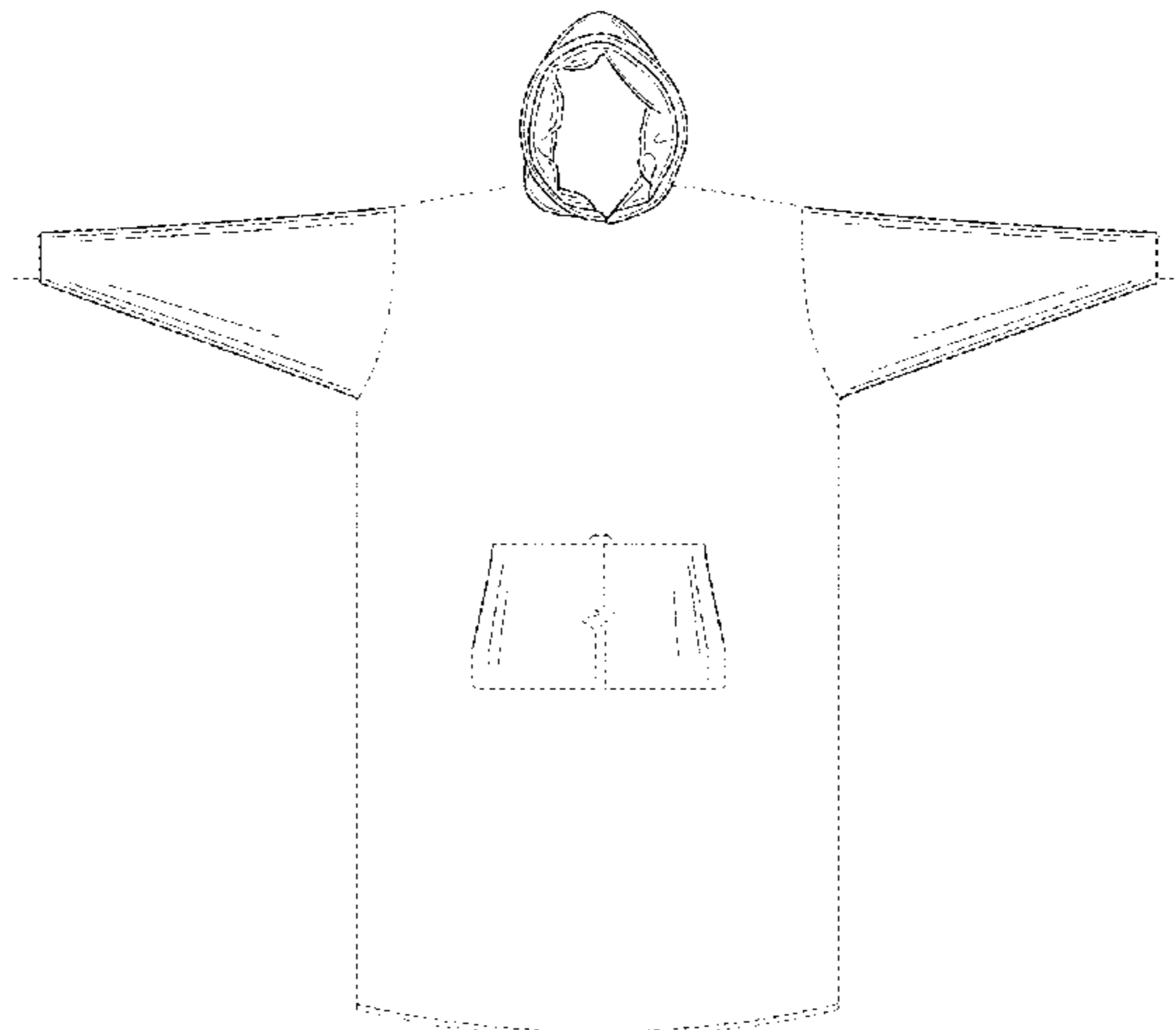

US D968,050 S

D553,330 S	10/2007	Wager	9,414,631 B2	8/2016	Schrimpf
7,296,303 B1	11/2007	Samet	D765,351 S	9/2016	Shaw
D561,430 S	2/2008	Vincenzo	D767,256 S	9/2016	Adrovic
D563,628 S	3/2008	Corbin et al.	D767,856 S	10/2016	Adrovic
D566,927 S	4/2008	Graham	D770,136 S	11/2016	Darmour
D568,581 S	5/2008	Wager	D774,282 S	12/2016	Ardalan
D570,577 S	6/2008	Keppler	D774,733 S	12/2016	Stevens
D584,482 S	1/2009	Marsh	9,521,873 B1	12/2016	Mignone
D588,338 S	3/2009	Self	D775,788 S	1/2017	Darmour
D590,131 S	4/2009	Rogondino	9,554,601 B2	1/2017	Arajakis
D590,132 S	4/2009	Rogondino	D778,033 S	2/2017	Darmour
D590,134 S	4/2009	Rogondino	D782,783 S	4/2017	Douglas et al.
D600,884 S	9/2009	Patton	D783,233 S	4/2017	Steel
D603,140 S	11/2009	Amador	D783,944 S	4/2017	Lomax
D604,479 S	11/2009	Roe et al.	D783,945 S	4/2017	Sisseren
7,684,755 B2	3/2010	Pierce et al.	D784,193 S	4/2017	Freddi et al.
D615,731 S	5/2010	Oneto	D784,659 S	4/2017	Darmour
D619,333 S	7/2010	Stowell	D785,906 S	5/2017	Darmour
D621,132 S	8/2010	Crisp	D786,537 S	5/2017	Ingram
D626,310 S	11/2010	Cruz	D787,160 S	5/2017	Crowe et al.
D627,540 S	11/2010	Claeys	D787,161 S	5/2017	Darmour
D629,590 S	12/2010	Freedman et al.	D789,042 S	6/2017	Lomax
D630,002 S	1/2011	Brown	D790,807 S	7/2017	Darmour
D630,003 S	1/2011	Brown	D790,808 S	7/2017	Blackford et al.
D633,691 S	3/2011	Tronvold	D790,809 S	7/2017	Lomax
D633,692 S	3/2011	Lawrence et al.	9,713,352 B2	7/2017	Demarest
D637,377 S	5/2011	Hertzen	D801,005 S	10/2017	Perez
D638,200 S	5/2011	Gorson	D802,886 S	11/2017	Salce et al.
D638,201 S	5/2011	Gosse	D805,732 S	12/2017	Bushby et al.
D638,202 S	5/2011	Gosse	D810,401 S	2/2018	Darmour
D653,836 S	2/2012	Woyschner et al.	D810,402 S	2/2018	Darmour
D655,894 S	3/2012	Crye	D811,051 S	2/2018	Darmour et al.
D659,350 S	5/2012	McDonnell	D820,560 S	6/2018	Reynolds et al.
D665,152 S	8/2012	Morales	10,034,503 B2	7/2018	Edwards et al.
D672,531 S	12/2012	Kelfer	D827,249 S	9/2018	Darmour et al.
D679,484 S	4/2013	Brown	D827,254 S	9/2018	Frierson
D684,341 S	6/2013	Freedman	10,130,126 B2	11/2018	Blauser et al.
D685,158 S	7/2013	Lambertz	D839,539 S	2/2019	Jones
D685,160 S	7/2013	Savage	D840,133 S	2/2019	Peck
D687,619 S	8/2013	Savage	D841,289 S	2/2019	Frost et al.
D689,669 S	9/2013	Williams	D854,787 S	7/2019	Ngan
D692,212 S	10/2013	Coward	D855,940 S	8/2019	Lomax
8,566,963 B2	10/2013	Ryan	D856,032 S	8/2019	Hindley
D693,543 S	11/2013	Rao	D859,788 S	9/2019	Speciale et al.
D695,491 S	12/2013	Hawkins et al.	10,420,431 B1	9/2019	Speciale et al.
D699,927 S	2/2014	Fujioka	D861,289 S	10/2019	Ngan
D700,418 S	3/2014	Borovicka et al.	D877,461 S	3/2020	Mieszczak
D701,368 S	3/2014	Borovicka et al.	10,609,968 B2	4/2020	Darmour et al.
D701,369 S	3/2014	Borovicka et al.	D885,712 S	6/2020	Hernandez
D704,924 S	5/2014	Roberts et al.	D886,416 S	6/2020	Speciale et al.
D706,020 S	6/2014	Hammel	D892,436 S *	8/2020	Francis D2/750
8,756,717 B2	6/2014	Claeys	D894,532 S	9/2020	Ngan
D707,923 S	7/2014	Borovicka et al.	D894,536 S	9/2020	Ngan
D708,423 S	7/2014	Adams et al.	D894,537 S	9/2020	Ngan
D714,527 S	10/2014	Borovicka	D895,933 S	9/2020	Morales
D717,524 S	11/2014	Allen et al.	10,772,366 B1	9/2020	Ngan
D719,722 S	12/2014	Bublak	D899,145 S	10/2020	Ngan
8,910,317 B2	12/2014	Decker	D902,532 S *	11/2020	Jager D2/831
D721,467 S	1/2015	Tref	D903,235 S	12/2020	Lv
8,942,403 B2	1/2015	Oman et al.	D903,237 S *	12/2020	Speciale D2/828
8,965,032 B2	2/2015	Wolfe	D903,981 S *	12/2020	Wood D2/828
D728,900 S	5/2015	White	D905,380 S *	12/2020	Speciale D2/828
D732,799 S	6/2015	Smith	D911,674 S *	3/2021	Wood D2/828
9,060,555 B1	6/2015	Harris et al.	D912,369 S	3/2021	Wu
D736,496 S	8/2015	Gonzalez	D912,370 S	3/2021	Ngan
D736,497 S	8/2015	Harris	D912,931 S	3/2021	Yan
D741,576 S	10/2015	Sakosits	D914,331 S	3/2021	Yan
D744,725 S	12/2015	Judge et al.	D916,436 S *	4/2021	Johansson D2/831
D746,550 S	1/2016	Roberts et al.	11,051,562 B2	7/2021	Rundle
D746,551 S	1/2016	Ingram	D933,334 S *	10/2021	Hsu D2/828
D747,075 S	1/2016	Ingram	D936,935 S *	11/2021	Zhou D2/831
D751,272 S	3/2016	Moehring	2001/0032360 A1	10/2001	Bertrand
9,295,292 B2	3/2016	Sachs	2003/0046748 A1	3/2003	Tanenbaum
D754,947 S	5/2016	Borovicka	2003/0061659 A1	4/2003	Dunlap et al.
D758,047 S	6/2016	Burlo	2005/0144695 A1	7/2005	Aldridge et al.
D758,699 S	6/2016	Darmour	2005/0217004 A1	10/2005	Haberfeld
9,364,038 B2	6/2016	Barrett	2006/0010555 A1	1/2006	Hayes et al.
D762,048 S	7/2016	Lomax	2006/0085887 A1	4/2006	Palomo et al.
D762,346 S	8/2016	Lomax	2006/0150295 A1	7/2006	Paternoster

2006/0285774	A1	12/2006	Carmody et al.
2007/0000030	A1	1/2007	Toomey et al.
2007/0061940	A1	3/2007	Cazares
2007/0074329	A1	4/2007	Marshall et al.
2007/0266473	A1	11/2007	Issel
2008/0196140	A1	8/2008	Mayerson et al.
2009/0100571	A1	4/2009	Soto
2009/0205117	A1	8/2009	Day et al.
2009/0229034	A1	9/2009	Zmigrosky
2009/0235426	A1	9/2009	Johnston et al.
2009/0293170	A1	12/2009	Kiker
2010/0024088	A1	2/2010	Griever
2011/0185471	A1	8/2011	Buczowski et al.
2011/0206299	A1	8/2011	Carmody
2012/0005801	A1	1/2012	Parr
2012/0005802	A1	1/2012	Claeys
2012/0144550	A1	6/2012	Nejad
2012/0284898	A1	11/2012	McMullen
2012/0311763	A1	12/2012	King
2013/0104281	A1	5/2013	Mattick
2013/0152270	A1	6/2013	Neal et al.
2013/0219581	A1	8/2013	Schrimpf
2013/0269082	A1	10/2013	Bramblet
2013/0276203	A1	10/2013	Pasko et al.
2013/0318679	A1	12/2013	Esquer
2014/0007316	A1	1/2014	Tommarello et al.
2014/0047614	A1	2/2014	Becton
2014/0245518	A1	9/2014	Claeys
2014/0310848	A1	10/2014	Ulriksen et al.
2014/0310850	A1	10/2014	Hudak et al.
2014/0317824	A1	10/2014	Browning et al.
2014/0331381	A1	11/2014	Arajakis
2015/0135398	A1	5/2015	Czajka et al.
2015/0181960	A1	7/2015	Goeglein
2015/0189924	A1	7/2015	Desbrow
2015/0196061	A1	7/2015	Oliver
2015/0296909	A1	10/2015	Sachs
2016/0242474	A1	8/2016	Baschak et al.
2016/0324236	A1	11/2016	Schrimpf
2016/0366953	A1	12/2016	Watts
2017/0020215	A1	1/2017	Merritt
2017/0079350	A1	3/2017	Hourani
2017/0112208	A1	4/2017	Kiker
2017/0119072	A1	5/2017	Coulombe
2017/0164665	A1	6/2017	Johnson
2018/0049483	A1	2/2018	Shore
2018/0049494	A1	2/2018	Darmour et al.
2018/0092410	A1	4/2018	Rundle
2018/0116300	A1	5/2018	Fleming
2018/0184729	A1*	7/2018	Rybak A41D 3/00
2018/0192753	A1	7/2018	Jarboe
2018/0235297	A1	8/2018	Buczowski et al.
2018/0310644	A1	11/2018	Poupyrev et al.
2019/0208936	A1	7/2019	Thomas
2019/0254410	A1	8/2019	Duvall et al.
2019/0289936	A1	9/2019	Hourani
2020/0008500	A1	1/2020	Speciale et al.
2020/0170315	A1	6/2020	Darmour et al.
2021/0015182	A1	1/2021	Dunn
2021/0068476	A1	3/2021	Watts
2021/0161220	A1	6/2021	Young

FOREIGN PATENT DOCUMENTS

CN	102860655	A	1/2013
CN	205585375	U	9/2016
CN	107713108	A	2/2018
CN	305238541		7/2019
DE	202013009697	U1	12/2013
DE	202014002960	U1	8/2014
DE	202014002963	U1	8/2014
DE	202015009314	U1	3/2017
EM	000891759001		4/2008
EM	001676404000		3/2010
EM	002237149000		5/2013
EM	001378590000		8/2013
EM	002441386000		4/2014
EM	001426902003		1/2015
EM	002804310000		10/2015

EM	002978601000		9/2016
EM	003126481001		12/2016
EM	003619766000		1/2017
EM	004173367002		9/2017
EM	000828017000		12/2017
EM	000875893001		3/2021
EM	001220461001		7/2021
JP	3148977	U	3/2009
KR	102110083	B1	5/2020
PL	20025	S2	11/2013
WO	011283		9/1988
WO	082169		11/2013
WO	2016117932	A1	7/2016
WO	2020023161	A1	1/2020

OTHER PUBLICATIONS

Felicigeely Blanket Sweatshirt, Oversized Fleecehug Hoodie Wearable Blanket, Soft Warm, posted 8/5/19 [online], (retrieved Mar. 24, 2021). Retrieved from the internet, https://www.amazon.com/dp/B081RY138W/ref=sspa_dk_detail_4?pd_rd_i=B081RXZHBQ&pd_rd_w=llgMO&pf_rd_p=4269e1a0-a218-4fbd-9748-1c%E2%80%A6%206 (Year: 2019).*

The Comfy Original, reviewed as early as Nov. 2, 2018 [online], (retrieved Nov. 4, 2021). Retrieved from the internet, <https://thecomfy.com/collections/the-blanket-you-can-wear/products/the-comfy?variant=6018286616604> (Year: 2018).*

The Comfy Original, posted Sep. 27, 2019 [online], (retrieved Nov. 4, 2021). Retrieved from the internet, https://www.amazon.com/COMFY-Original-Oversized-Microfiber-Wearable/dp/B07DKTDBWC/ref=sr_1_1_ (Year: 2019).*

(Continue from cite 'V') https://www.amazon.com/s?ref=sr_1_1_&sr=8-1-spons&psc=1&smid=AJ4XTLIKZHP6&spLa=ZW5jcmlwdGVkUXVhbGlnaWVvYyPUEySkU0WIVTVjJLM1FBjMmVuY3J5cHRl (Year: 2019).*

https://baseball.epicsports.com/prod/141055/a4-mens-cooling-performance-short-sleeve-hood-tee.html?utm_content=141055 (Year: 2021).*

<https://www.kingsize.com/products/liberty-blues-short-sleeve-hoodie/301226648.html>? (Year: 2021).*

Lasuntin Blanket Sweatshirt, Oversized Soft Sherpa Plush Wearable Hoodie Blankets, posted 2020 [online], (retrieved Mar. 7, 2022). Retrieved from the internet, https://www.amazon.com/Blanket-Sweatshirt-Oversized-Wearable-Blankets/dp/B08LC2G41H/ref=sr_1_2?crid=2QDDFNU3YD6B&keywords=the+pin%E2%80%A6 (Year: 2020).*

U.S. Appl. No. 16/576,125, filed Sep. 19, 2019, Brian Speciale.
 U.S. Appl. No. 29/617,421, filed Sep. 13, 2017, Brian Speciale.
 U.S. Appl. No. 29/645,978, filed Apr. 30, 2018, Brian Speciale.
 U.S. Appl. No. 29/705,878, filed Sep. 16, 2019, Brian Speciale.
 U.S. Appl. No. 29/731,083, filed Apr. 11, 2020, Brian Speciale.
 U.S. Appl. No. 29/731,086, filed Apr. 11, 2020, Brian Speciale.
 U.S. Appl. No. 29/749,467, filed Sep. 4, 2020, Brian Speciale.
 U.S. Appl. No. 29/749,476, filed Apr. 4, 2020, Brian Speciale.
 U.S. Appl. No. 29/759,308, filed Nov. 20, 2020, Brian Speciale.
 U.S. Appl. No. 29/759,310, filed Nov. 20, 2020, Brian Speciale.

[32% Off] 2020 Kangaroo Pocket Oversized Hoodie In APRICOT_ZAFUL (https://www.zaful.com/kangaroo-pocket-oversized-hoodie-p_487027.html).

2018 Kangaroo Pocket Oversize Hoodie (https://www.zaful.com/kangaroo-pocket-oversized-hoodie-p_487027.html).

Adidas Trefoil Hoodie—Blue_adidas US (<https://www.adidas.com/us/trefoil-hoodie/FM3784.html>).

Asos NYTT Long Sleeve Hoodie Dress, web page (<https://www.asos.com/nytt/nytt-long-sleeve-hoodie-dress/prd/6860969>) retrieved from Internet Archive Wayback Machine (<https://web.archive.org/web/20170307145645/https://www.asos.com/nytt/nytt-long-sleeve-hoodie-dress/prd/6860969>).

Chesterford Children's Lab Coats, web page (http://chesterford.co.uk/acatalog/Children_s_lab_coats.html) retrieved from Internet Archive Wayback Machine (https://www.archive.org/web/20160322191704/http://chesterford.co.uk/acatalog/Children_s_lab_coats.html).

Front Solid Full Regular Hoodie Half Zip Kangaroo Pocket Fluffy Hoodie (<https://www.daydaychic.com/Half-Zip-Kangaroo-Pocket-Fluffy-Hoodie-p-1000025963>).

Indigo Indigo Suede Hoodie Dress with Kangaroo Pocket—Toetally You (<https://www.toetallyyou.com/indigo-suede-hoodie-dress-with-kangaroo-pocket.html>).

Popular Color Block Drawstring Hooded Sweatshirt with Kangaroo Pocket—Beautifulhalo.com (<https://www.beautifulhalo.com/popular-color-block-drawstring-hooded-sweatshirt-with-kangaroo-pocket-p-260687.html>).

Stone Island Shadow Project Contrast Panel Drawstring Hoodie—Farfetch (<https://www.farfetch.com/shopping/men/stone-island-shadow-project-contrast-panel-drawstring-hoodie-item-15264001.aspx?storeid=10>).

Stone Island Shadow Project Men zipped pocket sweatshirt (<http://www.caribbeanmicrofinanceforum.com/stone-island-shadow-project-men-zipped-pocket-sweatshirt-boutique-high-quality-681960107-qacglom.html>).

Trefoil Oversize Hoodie (<https://www.adidas.com/us/trefoil-oversize-hoodie/CW1248.html>).

U.S. Appl. No. 29/767,561, filed Jan. 23, 2021, Brian Speciale.

U.S. Appl. No. 29/767,562, filed Jan. 23, 2021, Brian Speciale.

U.S. Appl. No. 29/767,563, filed Jan. 23, 2021, Brian Speciale.

U.S. Appl. No. 29/767,564, filed Jan. 23, 2021, Brian Speciale.

U.S. Appl. No. 29/775,218, filed Mar. 22, 2021, Brian Speciale.

Air-Flex Short Sleeve Gym Hoodie (https://tlfapparel.com/products/tlf-air-flex-short-sleeve-gym-hoodie-turbulence?variant=32297596551242¤cy=USD&utm_medium=product_sync&utm_source=google&utm_content=sag_organic&utm_campaign=sag_organic&gclid=cj0KCQjwsZKJBhC0ARIsAJ96n3XCnYOJgBE6j1AcSOi5763y9f9jh0Nk7T5_9fD2byhMunrGWWEaKUaArSmEALw_wcB).

Merc Hester Zip Thru Short Sleeve Hoodie (<https://www.merc.com/products/hester-zip-thru-short-sleeve-hoodie?variant=1622014777638>).

Pleadings—Davie—Defendant’s Invalidation Contentions.

Pleadings—Top Brand 43—Answer To First Amended Complaint for Declaratory Judgment and Counterclaims.

Pleadings—Top Brand 62—Second Amended Complaint.

Pleadings—Top Brand 66—Answer, Affirmative Defenses and Counterclaims of Counterclaim-Defendant John Ngan.

Pleadings—Top Brand 74—Defendants’ Answer and Affirmative Defenses To Counterclaims of Counterclaim-Defendant John Ngan.

Pleadings—Top Brand 77—Answer To Second Amended Complaint for Declaratory Judgment and Counterclaims.

Pleadings—Top Brand 85—Rule 16 Case Management Order.

Zara Short Sleeve Hooded Sweatshirt (https://www.zara.com/us/en/short-sleeve-hooded-sweatshirt-p04087464.html?v1=123839629&gclid=Cj0KCQjwsZKJBhC0ARIsAJ96n3WTQ72bGJS-ChGX2GHoWJmB13a6Zjw1pR8HFxxePg2fFOLIRZrBPv1aAindEALw_wcB).

“Images of prior art hooded sweatshirt” as alleged by disclosing party in Claim Construction Brief filed in Case No. 2:21-cv-00597-SPL. Date unknown and not provided by disclosing party.

Advertisements featured on “The Comfy” product packaging, as alleged by disclosing party in Claim Construction Brief filed in Case No. 2:21-cv-00597-SPL. Date unknown and not provided by disclosing party.

Amazon.com listing: Amazon Essentials Girls’ Pullover Hoodie Sweatshirt; disclosed by Examiner in U.S. Appl. No. 29/759,308; accessed by USPTO on Oct. 14, 2021; URL in screenshot.

Amazon.com Listing: Catalonia Oversized Hoodie Blanket Sweatshirt, Comfortable Sherpa Giant Pullover With Large Front Pocket For Adults Men Women Teenagers Wife Girlfriend; disclosed as an Exhibit in Pleadings in 2:21-cv-00310-MHB; alleged access date Oct. 1, 2021; URL in screenshot.

Amazon.com Listing: Felicigeely Blanket Sweatshirt, Oversized Fleecehug Hoodie Wearable Blanket, Soft Warm Comfortable Giant Front Pocket for Adults Men Women Teens Friends; disclosed as an Exhibit in Pleadings in 2:21-cv-00310-MHB; alleged access date Oct. 1, 2021; URL in screenshot.

Amazon.com listing: Joe’s USA Youth Hoodies—Pullover Hooded Sweatshirts in 24 Colors; disclosed by Examiner in U.S. Appl. No. 29/759,308; accessed by USPTO on Oct. 14, 2021; URL in screenshot
Amazon.com Listing: KPBLIS Wearable Blanket Sweatshirt, Giant Blanket Hoodie for Women and Men, Cozy Blanket With Sleeves and Large Front Pocket Adults, Teens (Dark Grey); disclosed as an Exhibit in Pleadings in 2:21-cv-00310-MHB; alleged access date Oct. 1, 2021; URL in screenshot.

Amazon.com listing: Pullover Hoodie (P473); disclosed by Examiner in U.S. Appl. No. 29/759,308; accessed by USPTO on Oct. 14, 2021; URL in screenshot.

Amazon.com listing: The Comfy Original | Oversized Microfiber & Sherpa Wearable Blanket, Seen on Shark Tank, One Size Fits All Blue; disclosed by Examiner in U.S. Appl. No. 29/759,308; Access date and URL were not provided by USPTO.

Defendant’s Invalidation Contentions; presented as Pleadings in 2:21-cv-00310-MHB; Oct. 1, 2021

Defendant’s Opening Claim Construction Brief; presented as Pleadings in Case 2:21-cv-00597-SPL; Oct. 29, 2021.

Enlarged image of Jan Claeissens’s 1628 oil on panels painting, “Four Panels: Saint Lawrence; Saint George; Saint Frances; and a Kneeling Donor”, as disclosed in Claim Construction brief in Case No. 2:21-cv-00597-SPL.

Excerpts of Webster’s New World Dictionary, © 1974 by William Collins + World Publishing Co., Inc.

Exhibit Index to Plaintiffs’ Opening Claim Construction Memorandum; presented as Pleadings in Case 2:21-cv-00597-SPL; Oct. 29, 2021.

Exhibits to Defendant’s Invalidation Contentions; presented as Pleadings in 2:21-cv-00310-MHB; Oct. 1, 2021.

Expert Report, Exhibit to Defendant’s Opening Claim Construction Brief; presented as Pleadings in Case 2:21-cv-00597-SPL; created Oct. 1, 2021, filed Oct. 29, 2021.

Facebook Post and Video Clip: The Oodie Sign Up Today And Save \$20 Dec. 28, 2018; URL: <https://www.facebook.com/TheOfficialOodie/videos/2206701302983818/> accessed Nov. 4, 2021.

Facebook Post and Video Clip: The Oodie The Highest Rated Wearable Blanket—Sep. 28, 2019; URL: <https://www.facebook.com/TheOfficialOodie/videos/737943896619105/> accessed Nov. 4, 2021.

Facebook.com: The Oodie—Premium Hooded Blankets Engineered For Comfort—Jul. 24, 2019; disclosed as an Exhibit in Pleadings in 2:21-cv-00310-MHB; alleged access date Oct. 1, 2021; URL in screenshot.

File History for U.S. Appl. No. 62/376,086, as disclosed by disclosing party in Claim Construction Brief filed in Case No. 2:21-cv-00597-SPL.

Image of a “The Comfy” Inner and Outer Layers, as submitted by disclosing party as Exhibit S to Claim Construction Brief filed in Case No. 2:21-cv-00597-SPL. Date unknown and not provided by disclosing party.

Kickstarter Campaign: The Comfy—Sweet Looking All Weather Sweater-knit Hoodies; URL: <https://www.kickstarter.com/projects/k-9/the-comfy-sweet-looking-all-weather-sweater-knit-h>; accessed Nov. 4, 2021.

Plaintiffs Opening Claim Construction Memorandum; presented as Pleadings in Case 2:21-cv-00597-SPL; Oct. 29, 2021.

Printout from www.sutori.com featuring article entitled “The History of the Hoodie/Sweatshirt,” as disclosed in Claim Construction brief in Case No. 2:21-cv-00597-SPL. Alleged access date Oct. 6, 2021; URL in Printout.

Printout of www.projecthatch.co Featuring Article by Brian and Michael Speciale; as disclosed in Claim Construction brief in Case No. 2:21-cv-00597-SPL; access date unknown and not provided by disclosing party in Case; URL in screenshot.

Video corresponding to NPL disclosed as “Amazon.com Listing: Catalonia Oversized Hoodie Blanket Sweatshirt . . .” A digital file of this video has been recorded onto to CD-ROM media and mailed to the USPTO with instructions to place that digital file into the file wrapper of this application.

Video corresponding to NPL disclosed as “Amazon.com Listing: KPBLIS Wearable Blanket Sweatshirt . . .” A digital file of this

video has been recorded onto to CD-ROM media and mailed to the USPTO with instructions to place that digital file into the file wrapper of this application.

Video corresponding to NPL disclosed as “Facebook.com: The Oodie—Premium Hooded Blankets Engineered For Comfort” A digital file of this video has been recorded onto to CD-ROM media and mailed to the USPTO with instructions to place that digital file into the file wrapper of this application.

Video corresponding to the NPL disclosed as “YouTube.com: The Warmest blanket sweatshir ever! . . .” A digital file of this video has been recorded onto to CD-ROM media and mailed to the USPTO with instructions to place that digital file into the file wrapper of this application.

Video: The Comfy on Shark Tank, Dec. 3, 2017 episode. A digital file of this video has been recorded onto to CD-ROM media and mailed to the USPTO with instructions to place that digital file into the file wrapper of this application.

Video: Woman wearing green wearable blanket in a beige living room. Date unknown. This is the video for NPL disclosed as “Feliciqeely . . .” A digital file of this video has been recorded onto to CD-ROM media and mailed to the USPTO with instructions to place that digital file into the file wrapper of this application.

Vimeo.com Video clip: Comfy Mason Jar Video; available <https://vimeo.com/241577062>; accessed Nov. 4, 2021; alleged to be available on Nov. 6, 2017 in Pleadings in 2:21-cv-00310-MHB.

Vimeo.com: The Comfy on Shark Tank—Dec. 3, 2017; disclosed as an Exhibit in Pleadings in 2:21-cv-00310-MHB; alleged access date Oct. 1, 2021; URL in screenshot.

Website Featuring Jan Claeissens’s 1628 oil on panels painting, “Four Panels: Saint Lawrence; Saint George; Saint Frances; and a Kneeling Donor”, as disclosed in Claim Construction Brief in Case No. 2:21-cv-00597-SPL.

YouTube.com: The Warmest blanket sweatshirt ever! ‘The Oodie’ unboxing & honest review, by InfiniteBeauty7 on Nov. 10, 2012; disclosed as an Exhibit in Pleadings in 2:21-cv-00310-MHB; alleged access date Oct. 1, 2021; URL in screenshot.

U.S. Appl. No. 29/731,086, filed Apr. 11, 2020.

U.S. Appl. No. 29/749,467, filed Sep. 4, 2020.

U.S. Appl. No. 29/749,476, filed Sep. 4, 2020.

U.S. Appl. No. 29/759,308, filed Nov. 20, 2020.

U.S. Appl. No. 29/759,310, filed Nov. 20, 2020.

U.S. Appl. No. 29/767,561, filed Jan. 23, 2021.

U.S. Appl. No. 29/767,562, filed Jan. 23, 2021.

U.S. Appl. No. 29/767,563, filed Jan. 23, 2021.

U.S. Appl. No. 29/767,564, filed Jan. 23, 2021.

U.S. Appl. No. 29/775,218, filed Mar. 22, 2021.

U.S. Appl. No. 16/576,125, filed Sep. 19, 2021.

Amazon.com Listing for Amazon Essentials Girl’s Pullover Hoodie Sweatshirt, screenshot captured Oct. 14, 2021, accessed at https://www.amazon.com/Amazon-Essentials-Toddler-Pullover-Sweatshirt/dp/B07PZ8LTK3/ref=cm_cr_ar_p_d_product_top?ie=UTF8.

Amazon.com Listing for Joe’s USA Youth Hoodies—Pullover Hooded Sweatshirts in 24 Colors, screenshot taken Oct. 14, 2021, accessed at [https://www.amazon.com/Joes-USA-Youth-Soft-Hoodies/dp/B00k6J5U46/ref=sr_1_7?crd=GPRFSQ6LPHV6&dchild=1&keywords=hoodie&2Bwithout \(as captured\)](https://www.amazon.com/Joes-USA-Youth-Soft-Hoodies/dp/B00k6J5U46/ref=sr_1_7?crd=GPRFSQ6LPHV6&dchild=1&keywords=hoodie&2Bwithout (as captured)).

Amazon.com Listing for Pullover Hoodie, screengrab on Oct. 14, 2021, accessed at [https://www.amazon.com/Hanes-EcoSmart-Hooded-Sweatshir-Heather/dp/B07ZJRW5PH/ref=sr_1_210?dchild=1&keywords=hoodie%2Bwithout%2B . . . \(URL Captured in screengrab\)](https://www.amazon.com/Hanes-EcoSmart-Hooded-Sweatshir-Heather/dp/B07ZJRW5PH/ref=sr_1_210?dchild=1&keywords=hoodie%2Bwithout%2B . . . (URL Captured in screengrab)).

Defendant’s Opening Ciain Construction Brief, in Case 2:21-cv-00597-SPL; filed Oct. 29, 2021.

Defendant’s Responsive Ciain Corastruction Brief, in Case 2:21-cv-00597-SPL; filed Dec. 3, 2021.

Exhibit A to Defendant’s Responsive Claim Construction Brief, in Case 2:21-CV-00597-SPL; filed Dec. 3, 2021; disclosing U.S. Appl. No. 62/558,136, filed Sep. 13, 2017.

Plaintiff’s Opening Claim Construction Memorandum, in Case 2:21-cv-00597-SPL; filed Oct. 29, 2021.

Plaintiff’s Responsive Claim Construction Memorandum; in Case 2:21-cv-00597-SPL; filed Dec. 3, 2021.

Catalonia Fleece Wearable Blanket Poncho; Walmart.com listing, accessed by USPTO on Mar. 8, 2022 at <https://www.walmart.com/>

[ip/Fleece-Wearable-Blanket-Poncho-for-Adult-Women-Men-Wrap-Blanket-Cape-with-Pocket-Warm-Soft-Cozy-Snuggly-Comfort-Gift-No-Sleeves-Aqua/291035469](https://www.walmart.com/ip/Fleece-Wearable-Blanket-Poncho-for-Adult-Women-Men-Wrap-Blanket-Cape-with-Pocket-Warm-Soft-Cozy-Snuggly-Comfort-Gift-No-Sleeves-Aqua/291035469).

Concolorist Wearable Blanket Sweatshirt; Amazon.com listing: Accessed by USPTO on Mar. 8, 2022 at https://www.amazon.com/dp/B0CK844FK/ref=sspa_dk_retail_1?pd_rd=i=B09CKLZN98&pd_rd_w=HIFKL&pf_rd_p=b9951ce4-3bd8-4b04-9123-0fda%E2%80%A6.

Lasuntin Blanket Sweatshirt; Amazon.com listing: accessed by USPTO on Mar. 7, 2022 at https://www.amazon.com/Blanket-Sweatshirt-Oversized-Wearable-Blankets/dp/B08LC2G4H/ref=sr_1_2?crd=2QDDFNU3YD6B&keywords=the+pin%E2%80%A6.

Office Action dated Apr. 26, 2022, in U.S. Appl. No. 90/764,005 which presented evidence comprising screenshots of various websites taken on Apr. 26, 2022, including Applicant’s own website thecomfy.com URLs for the other websites are noted on the Trademarks Examiner’s screenshots.

SoCo Hoddie The Long Flannel Blanket Hoodie Oversized Wearable Blankets; accessed by USPTO on Mar. 29, 2022 at <https://socohoodie.com/products/the-long-flannel-blanket-hoodie?variant=41201952063687¤cy=USD&utm>.

* cited by examiner

Primary Examiner — Kevin K Rudzinski

Assistant Examiner — J. Thorn, Sr.

(74) *Attorney, Agent, or Firm* — Thomas W. Galvani, P.C.; Thomas W. Galvani

(57)

CLAIM

The ornamental design for a whole body wearable blanket, as shown and described.

DESCRIPTION

FIG. 1 is a top front perspective view of a whole body wearable blanket shown in accordance with our new design; FIG. 2 is a top rear perspective view of the whole body wearable blanket shown in FIG. 1;

FIG. 3 is a front elevation view of the whole body wearable blanket shown in FIG. 1;

FIG. 4 is a rear elevation view of the whole body wearable blanket shown in FIG. 1;

FIG. 5 is a left side elevation view of the whole body wearable blanket shown in FIG. 1;

FIG. 6 is a right side elevation view of the whole body wearable blanket shown in FIG. 1;

FIG. 7 is a top plan view of the whole body wearable blanket shown in FIG. 1; and

FIG. 8 is a bottom plan view of the whole body wearable blanket shown in FIG. 1;

FIG. 9 is a top front perspective view of a whole body wearable blanket shown in accordance with our new design;

FIG. 10 is a top rear perspective view of the whole body wearable blanket shown in FIG. 9;

FIG. 11 is a front elevation view of the whole body wearable blanket shown in FIG. 9;

FIG. 12 is a rear elevation view of the whole body wearable blanket shown in FIG. 9;

FIG. 13 is a left side elevation view of the whole body wearable blanket shown in FIG. 9;

FIG. 14 is a right side elevation view of the whole body wearable blanket shown in FIG. 9;

FIG. 15 is a top plan view of the whole body wearable blanket shown in FIG. 9; and

FIG. 16 is a bottom plan view of the whole body wearable blanket shown in FIG. 9;

FIG. 17 is a top front perspective view of a whole body wearable blanket shown in accordance with our new design; FIG. 18 is a top rear perspective view of the whole body wearable blanket shown in FIG. 17; FIG. 19 is a front elevation view of the whole body wearable blanket shown in FIG. 17; FIG. 20 is a rear elevation view of the whole body wearable blanket shown in FIG. 17; FIG. 21 is a left side elevation view of the whole body wearable blanket shown in FIG. 17; FIG. 22 is a right side elevation view of the whole body wearable blanket shown in FIG. 17; FIG. 23 is a top plan view of the whole body wearable blanket shown in FIG. 17; and FIG. 24 is a bottom plan view of the whole body wearable blanket shown in FIG. 17; FIG. 25 is a top front perspective view of a whole body wearable blanket shown in accordance with our new design; FIG. 26 is a top rear perspective view of the whole body wearable blanket shown in FIG. 25; FIG. 27 is a front elevation view of the whole body wearable blanket shown in FIG. 25; FIG. 28 is a rear elevation view of the whole body wearable blanket shown in FIG. 25; FIG. 29 is a left side elevation view of the whole body wearable blanket shown in FIG. 25; FIG. 30 is a right side elevation view of the whole body wearable blanket shown in FIG. 25; FIG. 31 is a top plan view of the whole body wearable blanket shown in FIG. 25; and FIG. 32 is a bottom plan view of the whole body wearable blanket shown in FIG. 25; FIG. 33 is a top front perspective view of a whole body wearable blanket shown in accordance with our new design;

FIG. 34 is a top rear perspective view of the whole body wearable blanket shown in FIG. 33; FIG. 35 is a front elevation view of the whole body wearable blanket shown in FIG. 33; FIG. 36 is a rear elevation view of the whole body wearable blanket shown in FIG. 33; FIG. 37 is a left side elevation view of the whole body wearable blanket shown in FIG. 33; FIG. 38 is a right side elevation view of the whole body wearable blanket shown in FIG. 33; FIG. 39 is a top plan view of the whole body wearable blanket shown in FIG. 33; and FIG. 40 is a bottom plan view of the whole body wearable blanket shown in FIG. 33; FIG. 41 is a top front perspective view of a whole body wearable blanket shown in accordance with our new design; FIG. 42 is a top rear perspective view of the whole body wearable blanket shown in FIG. 41; FIG. 43 is a front elevation view of the whole body wearable blanket shown in FIG. 41; FIG. 44 is a rear elevation view of the whole body wearable blanket shown in FIG. 41; FIG. 45 is a left side elevation view of the whole body wearable blanket shown in FIG. 41; FIG. 46 is a right side elevation view of the whole body wearable blanket shown in FIG. 41; FIG. 47 is a top plan view of the whole body wearable blanket shown in FIG. 41; and, FIG. 48 is a bottom plan view of the whole body wearable blanket shown in FIG. 41. The features shown in broken lines illustrate portions of the article which form no part of the claimed design.

1 Claim, 36 Drawing Sheets

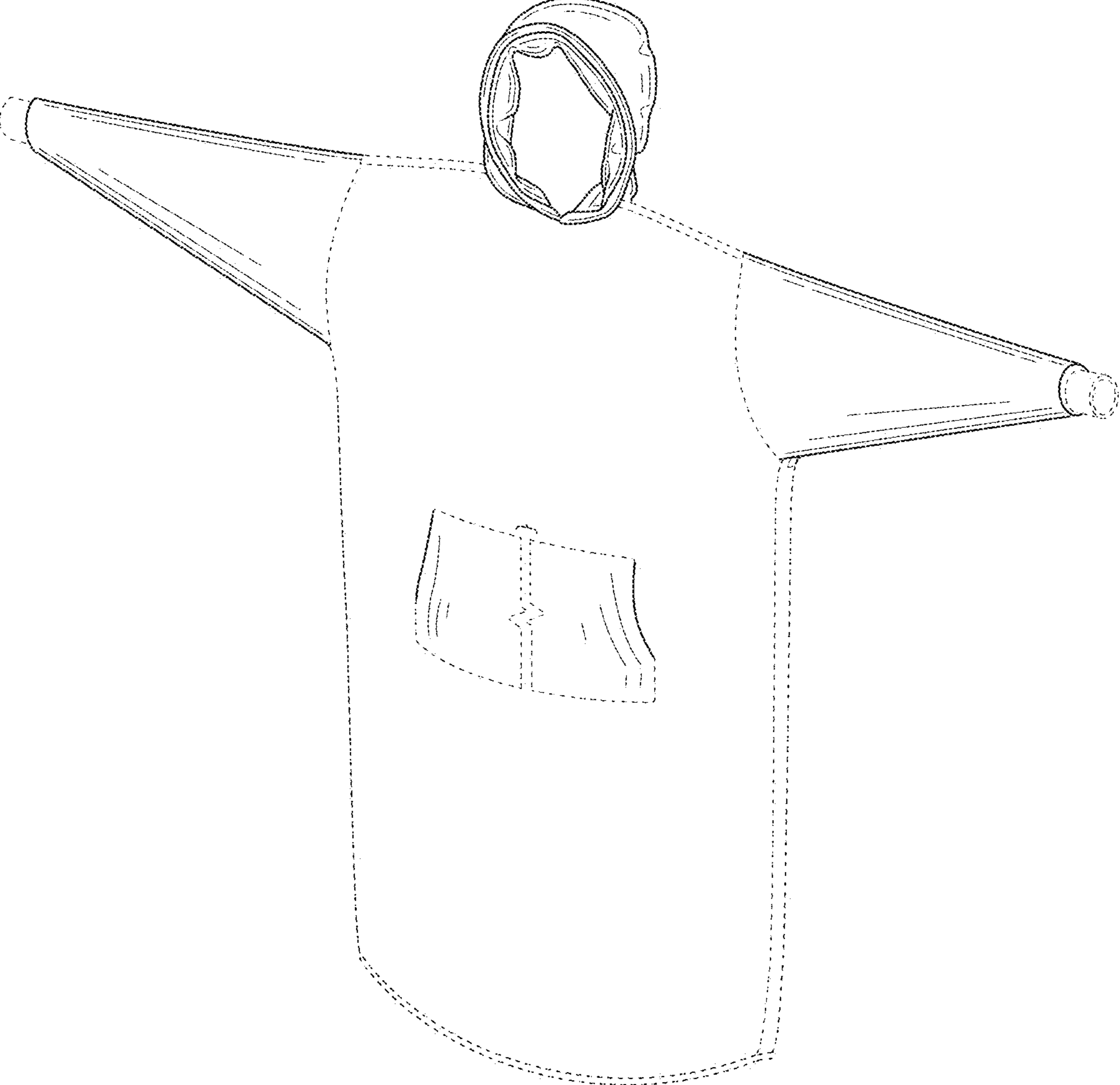

FIG. 1

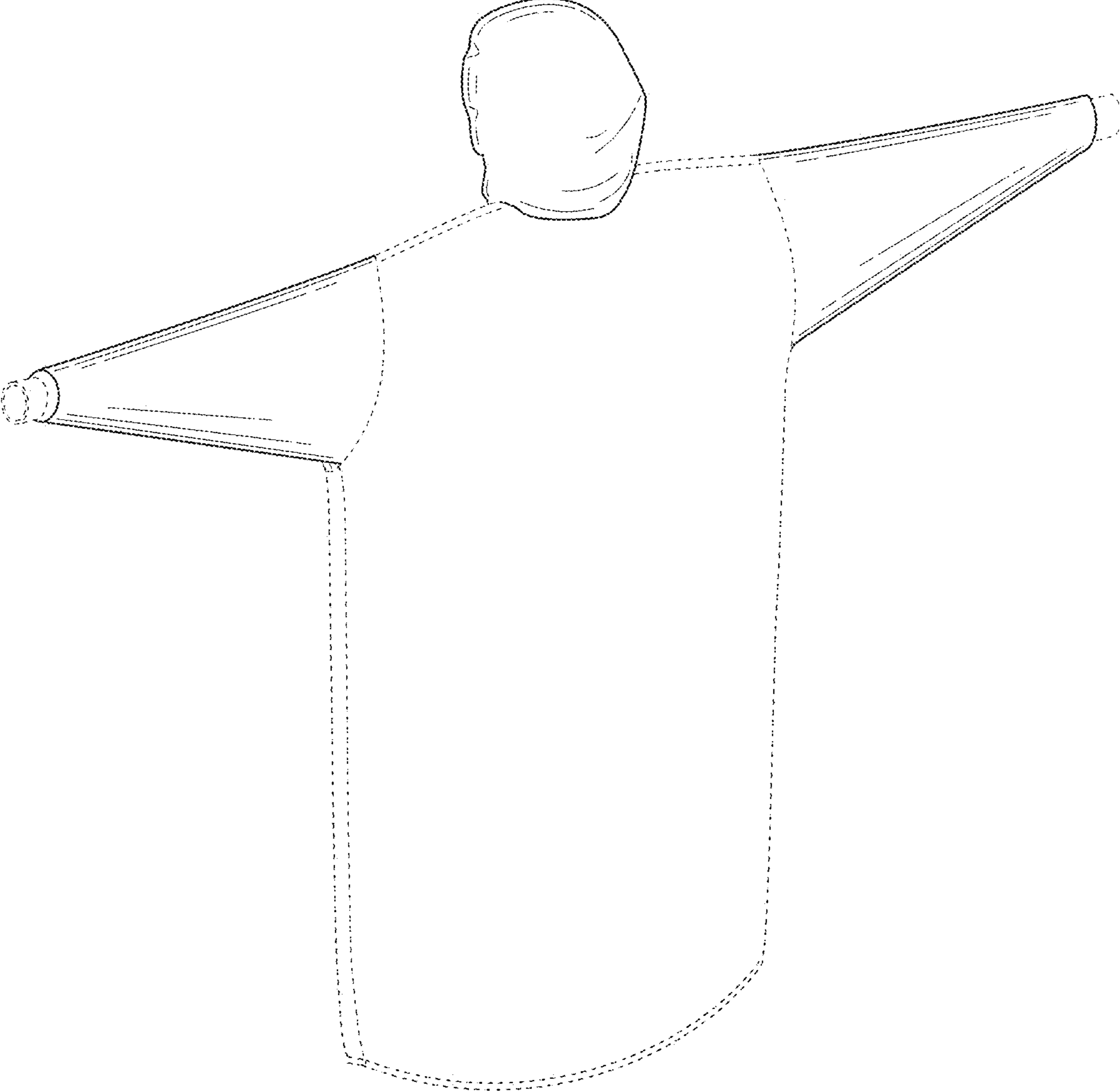

FIG. 2

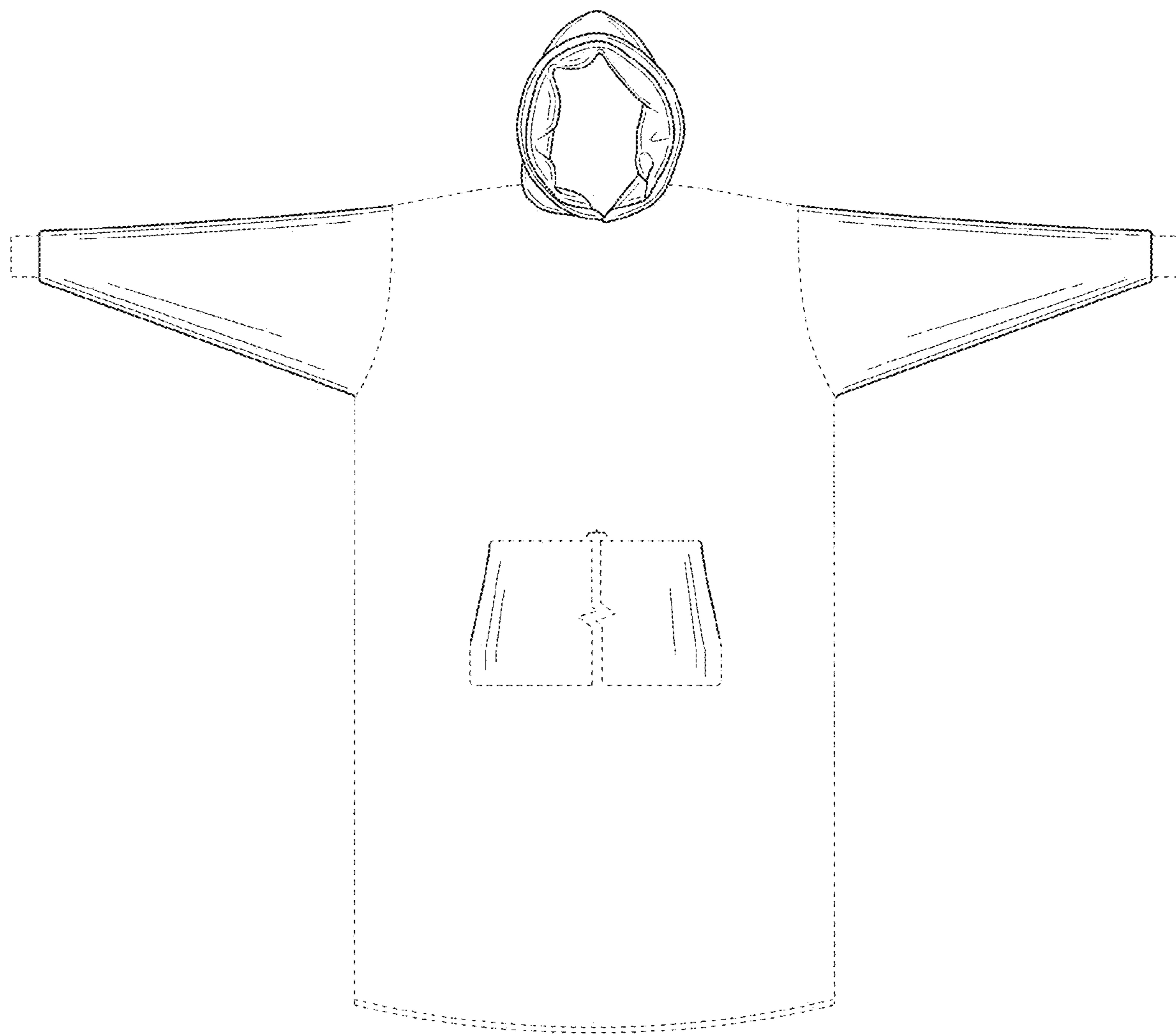

FIG. 3

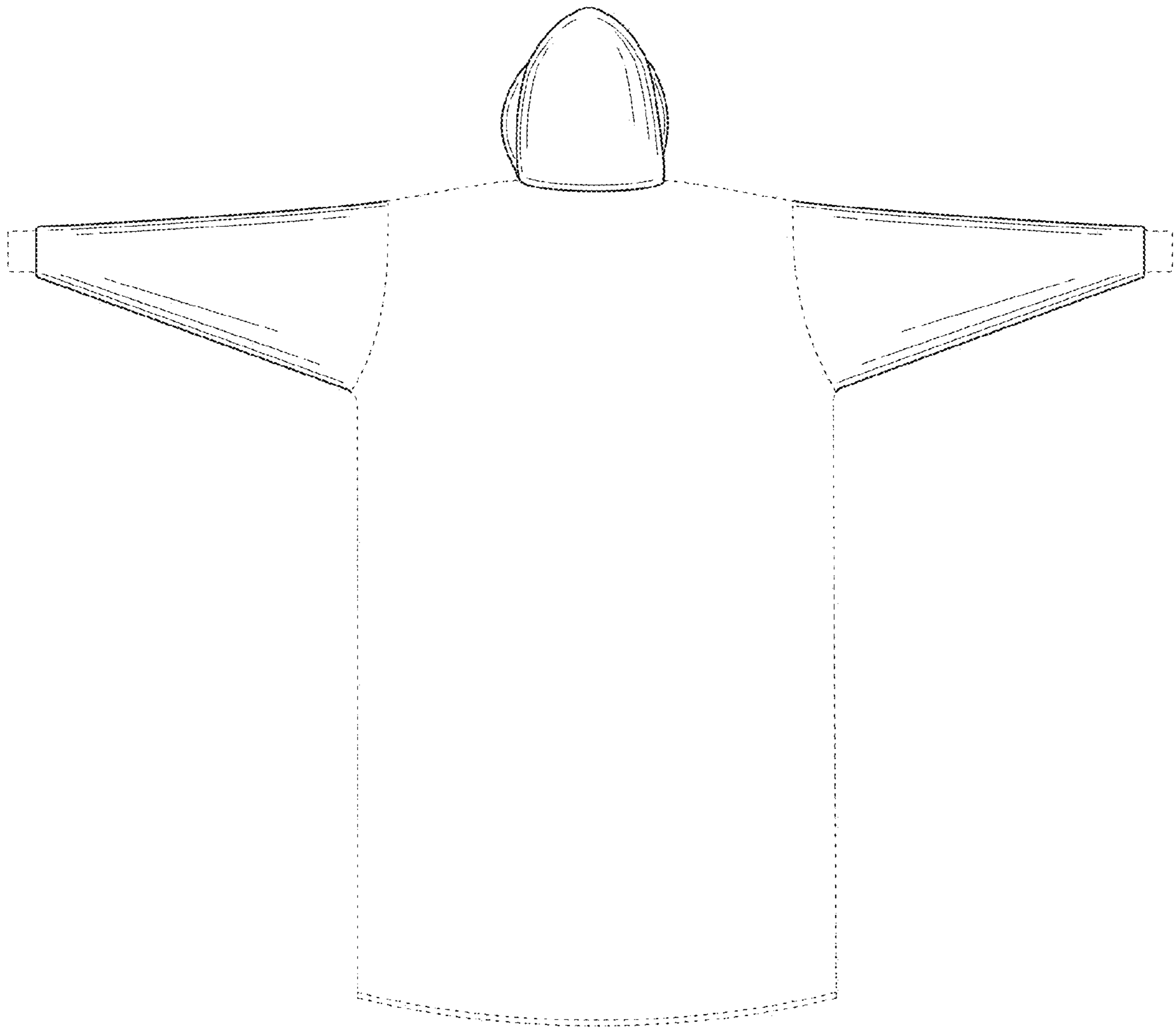

FIG. 4

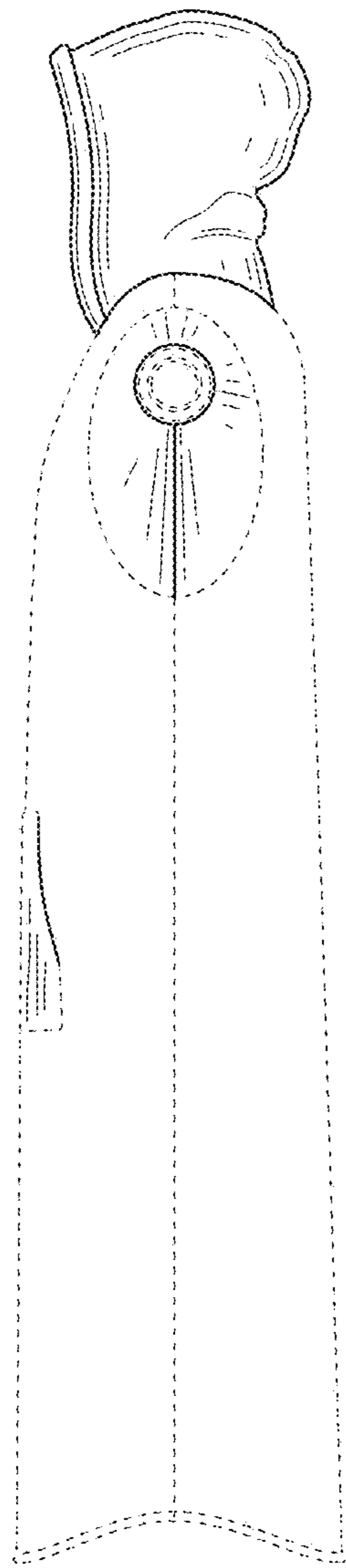

FIG. 5

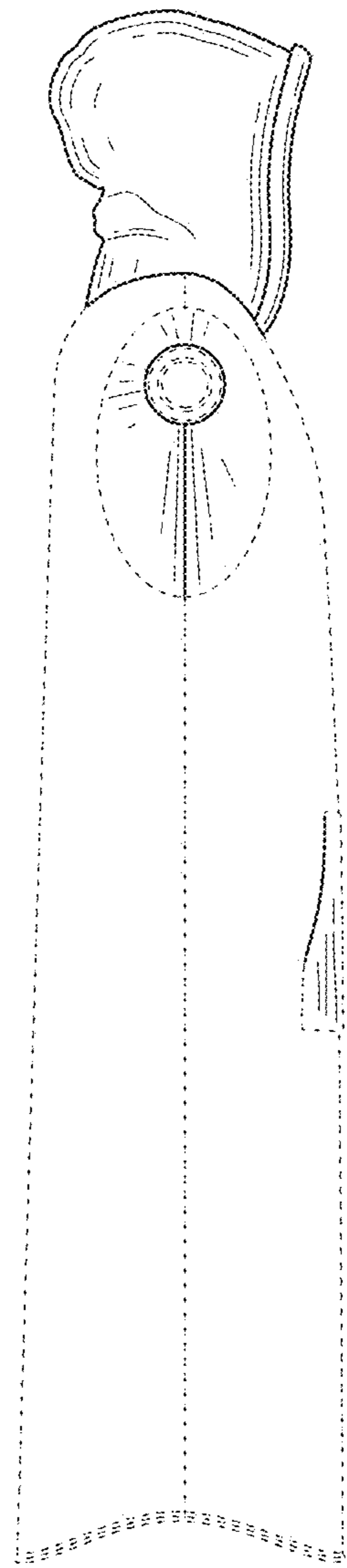

FIG. 6

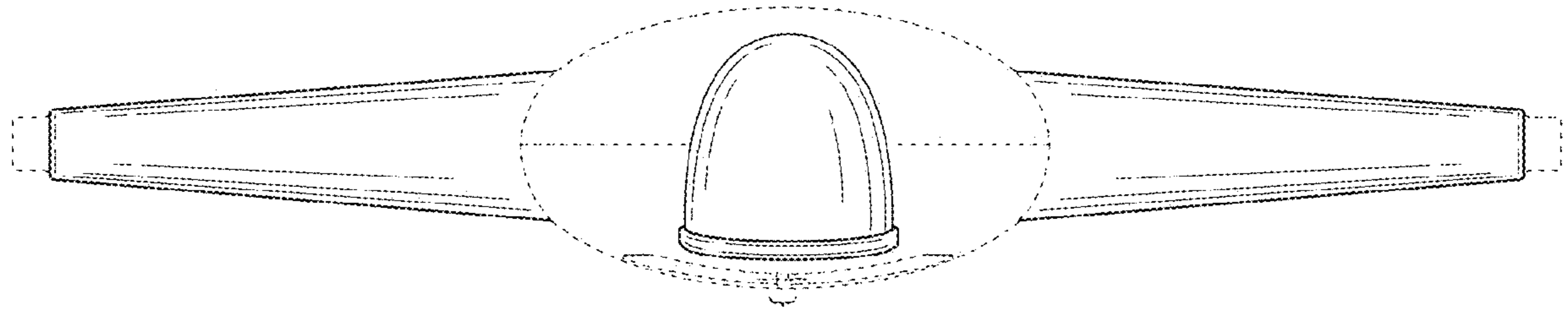

FIG. 7

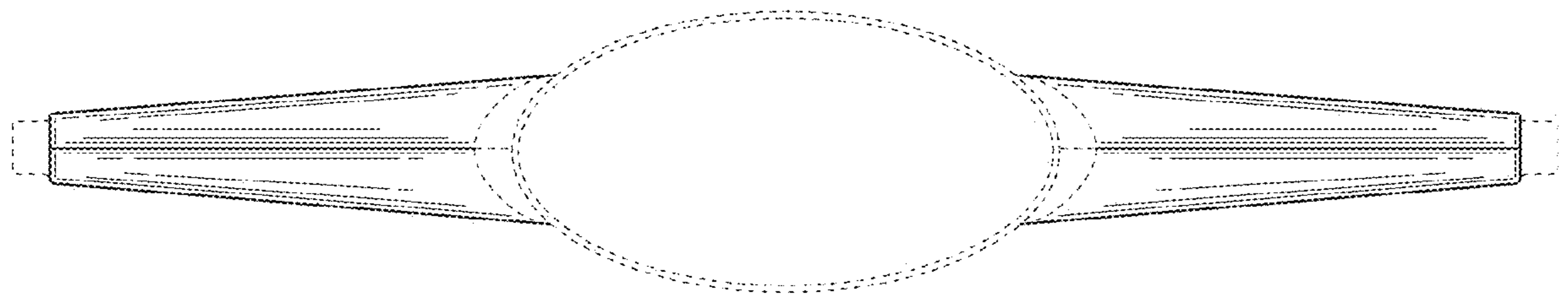

FIG. 8

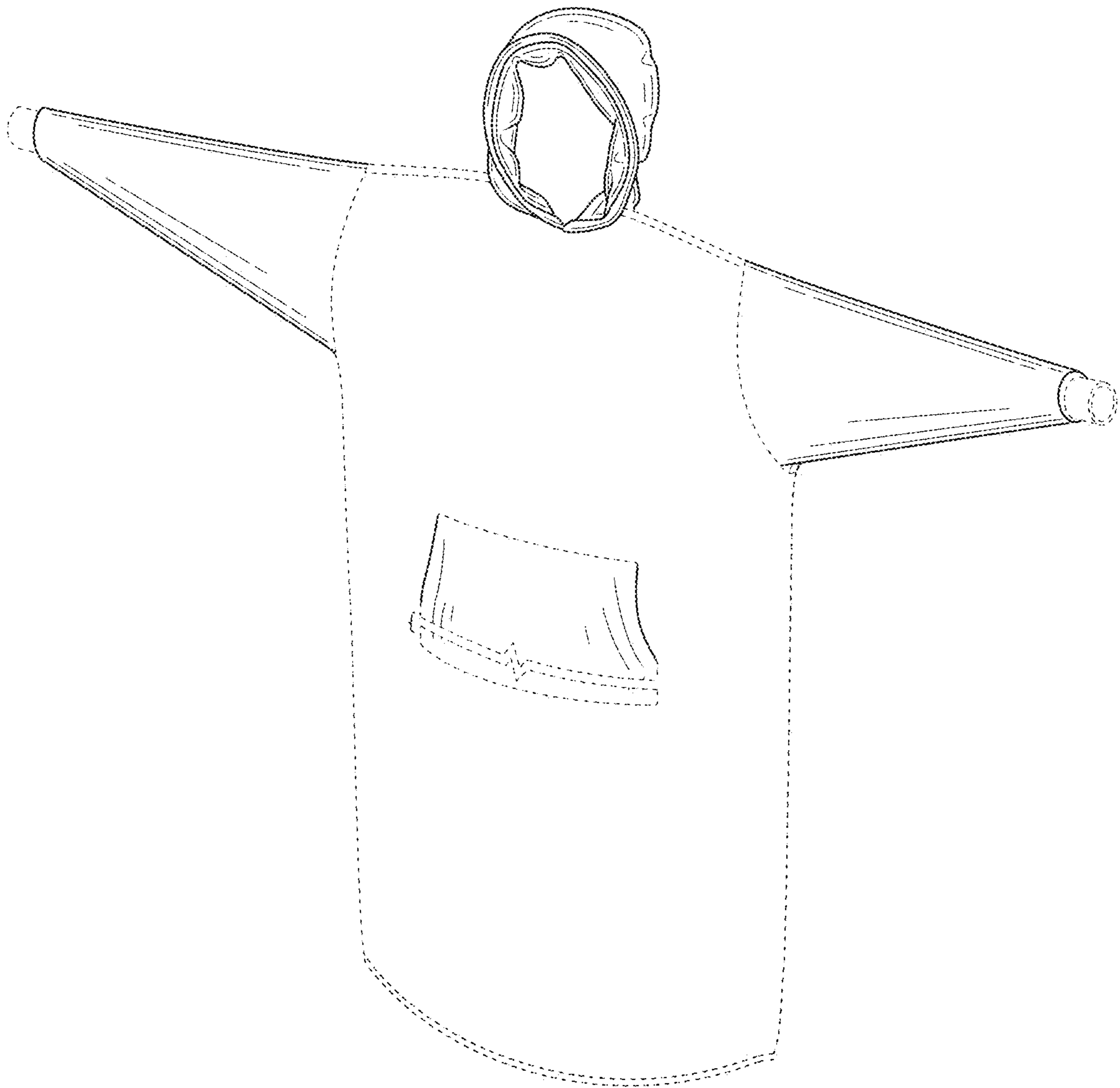

FIG. 9

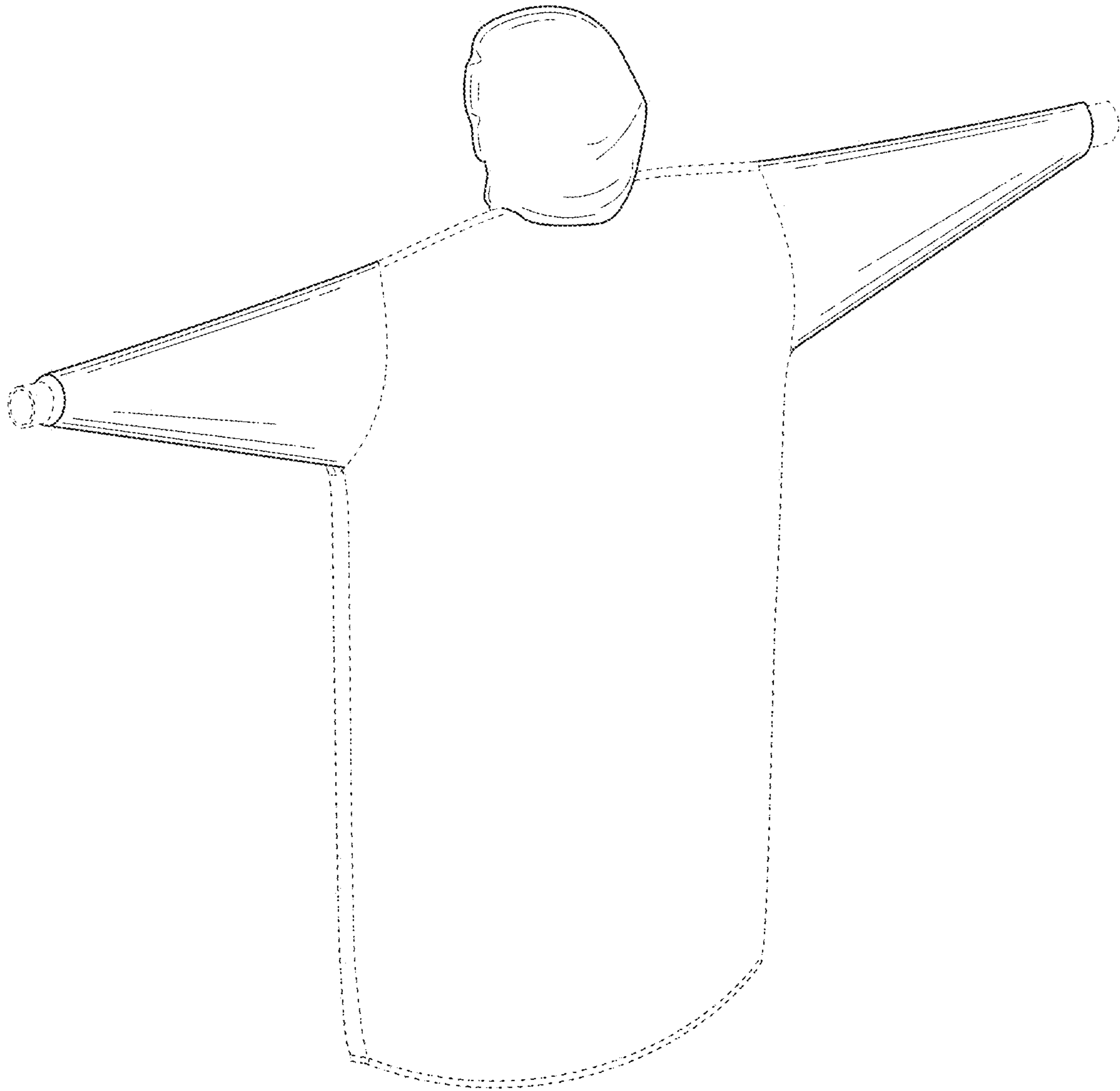

FIG. 10

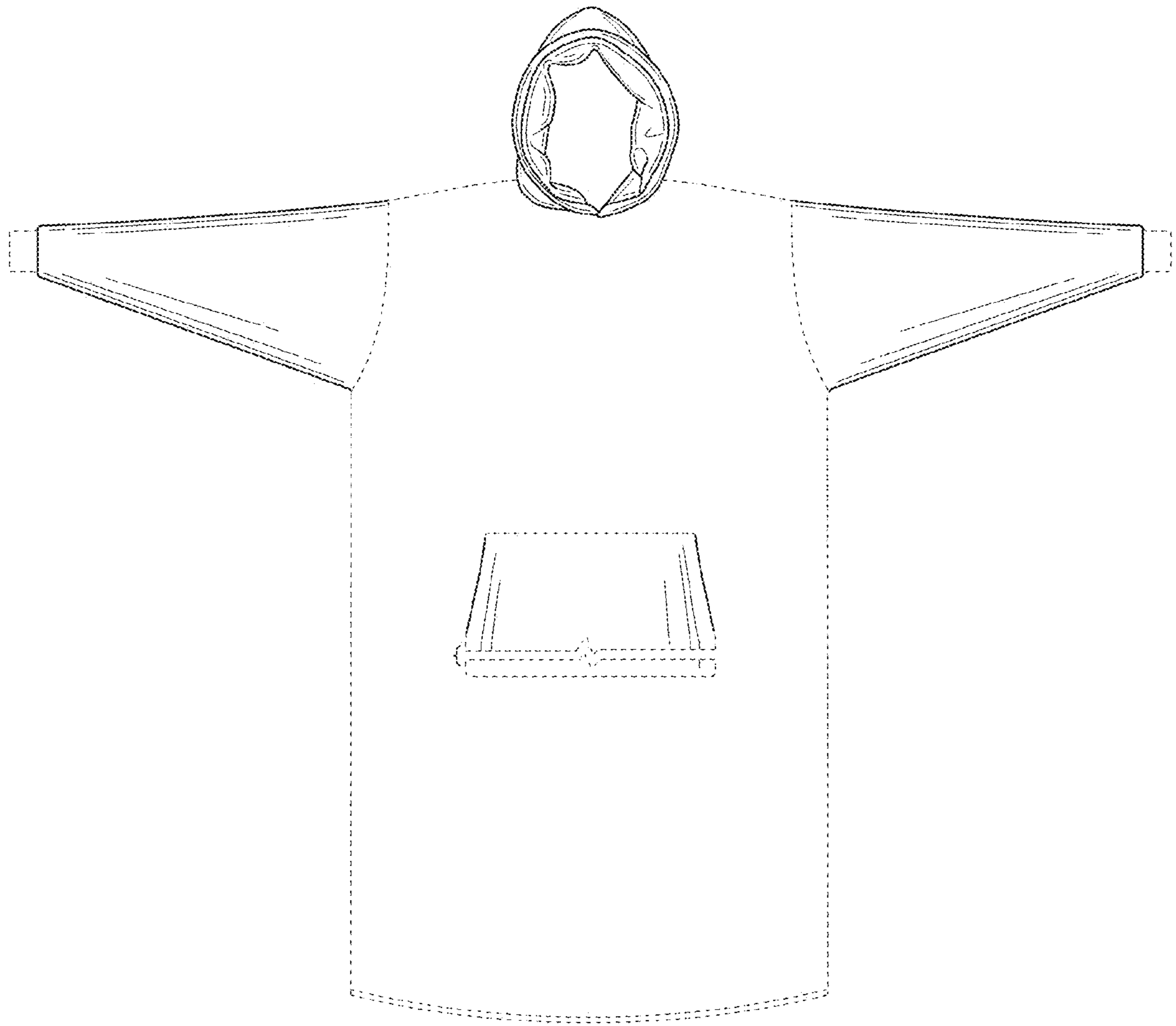

FIG. 11

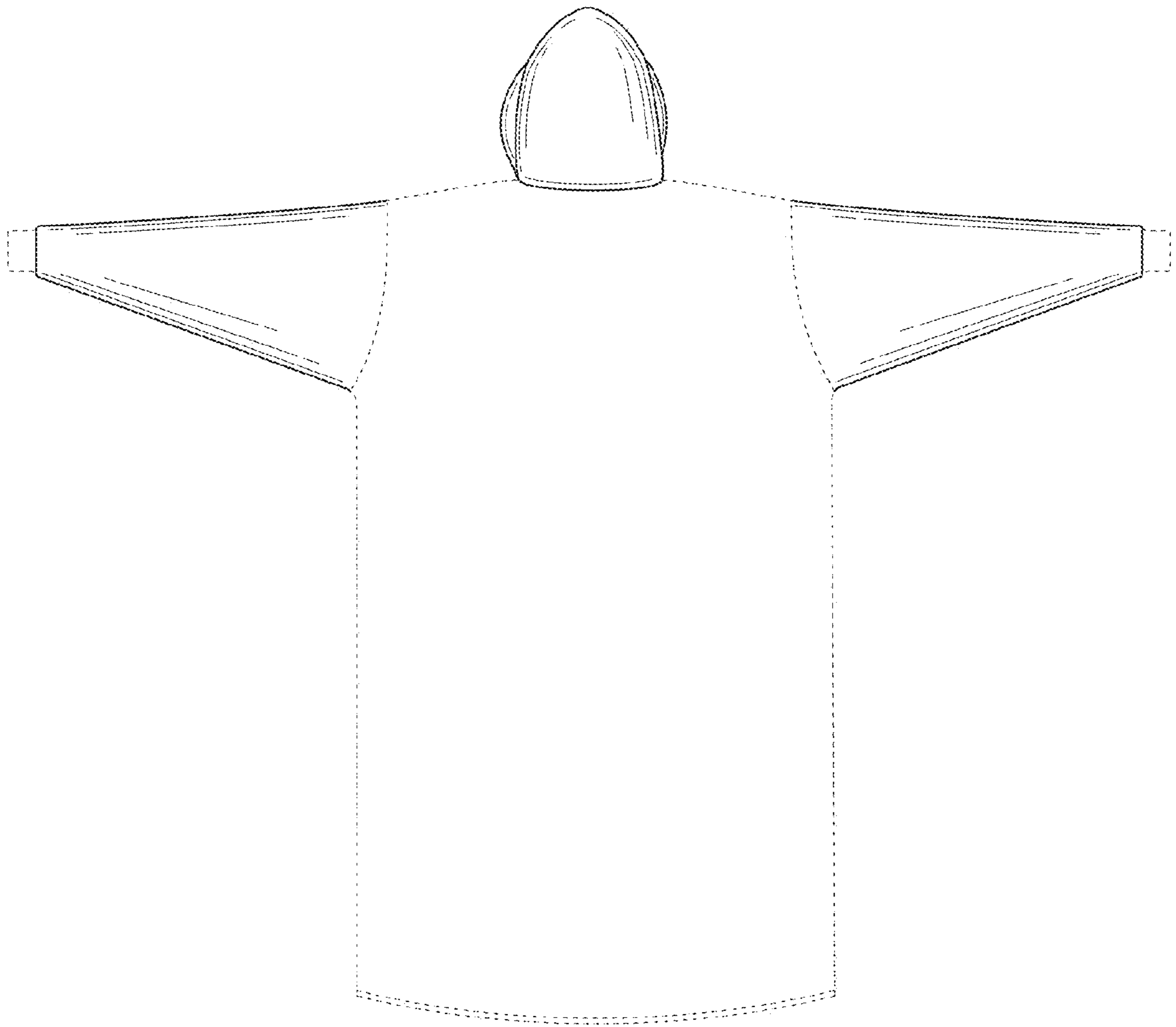

FIG. 12

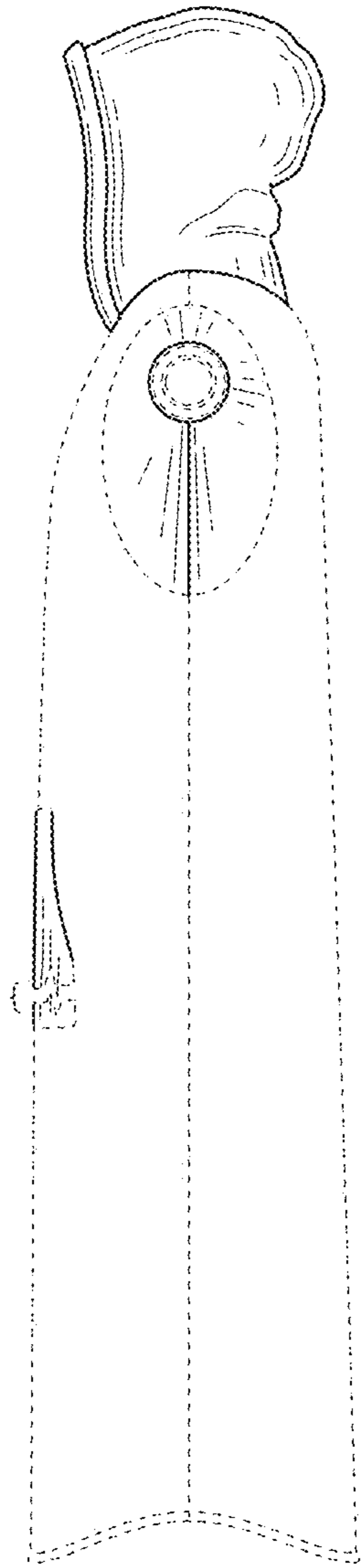

FIG. 13

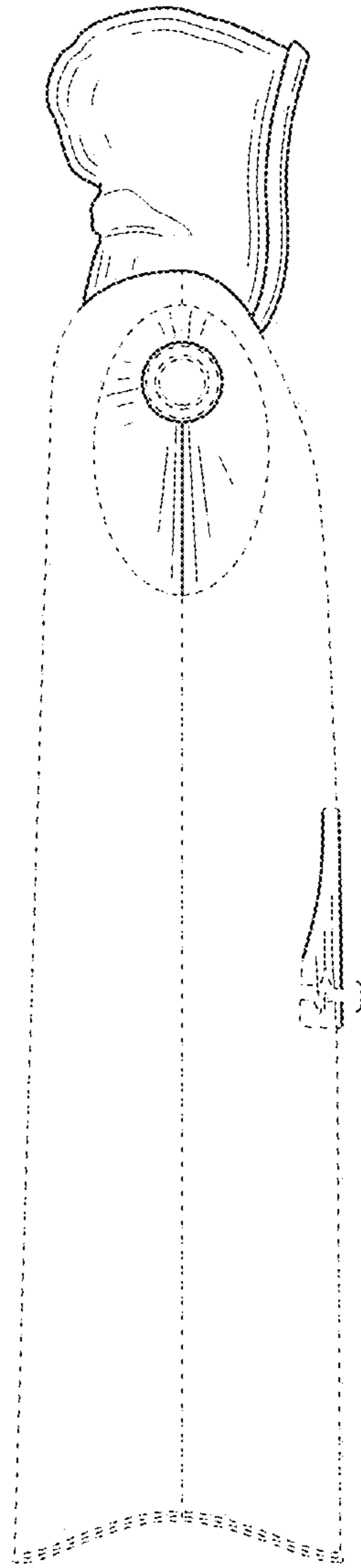

FIG. 14

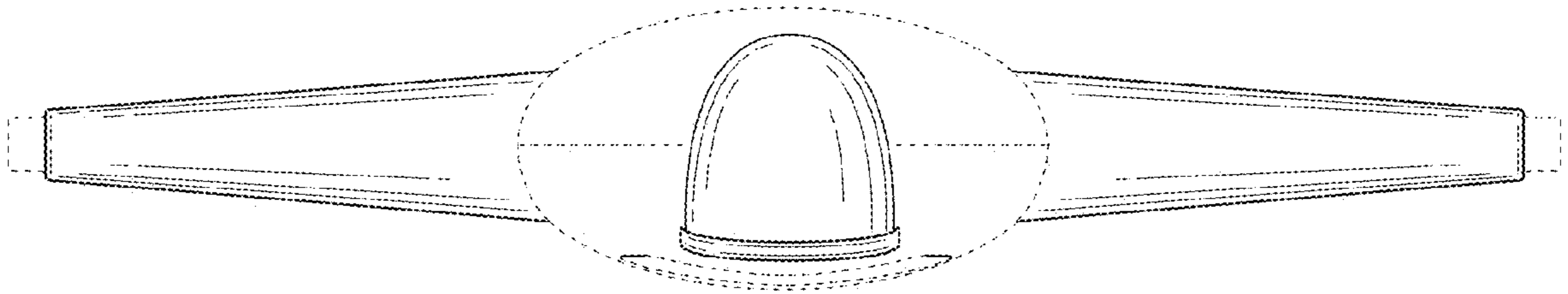

FIG. 15

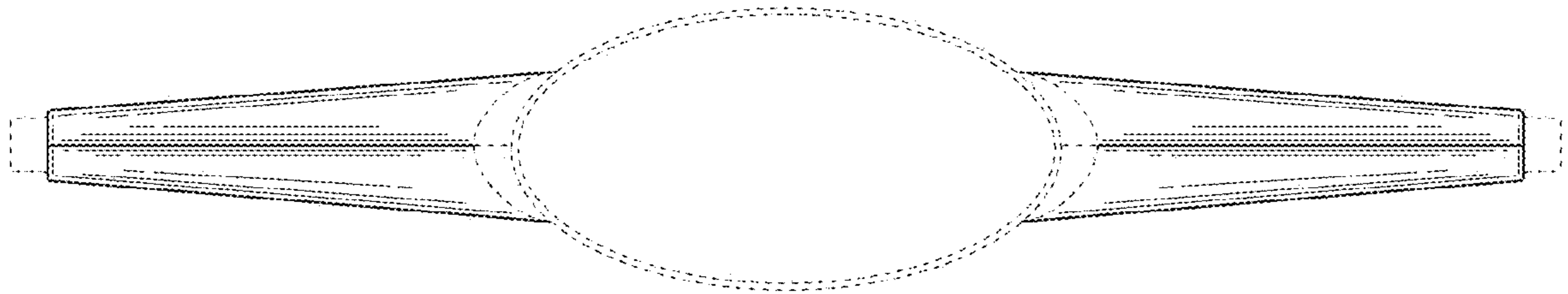

FIG. 16

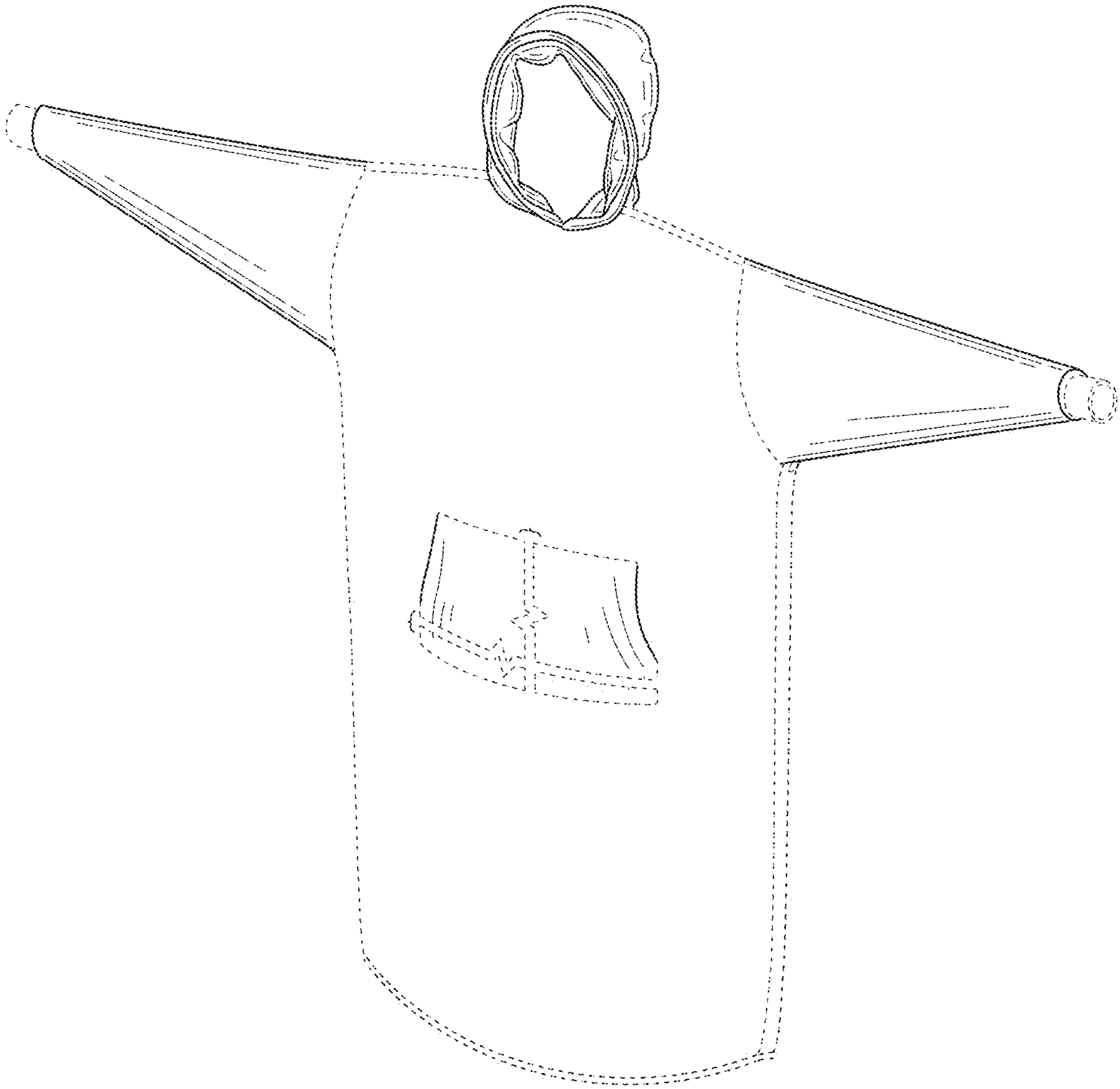

FIG. 17

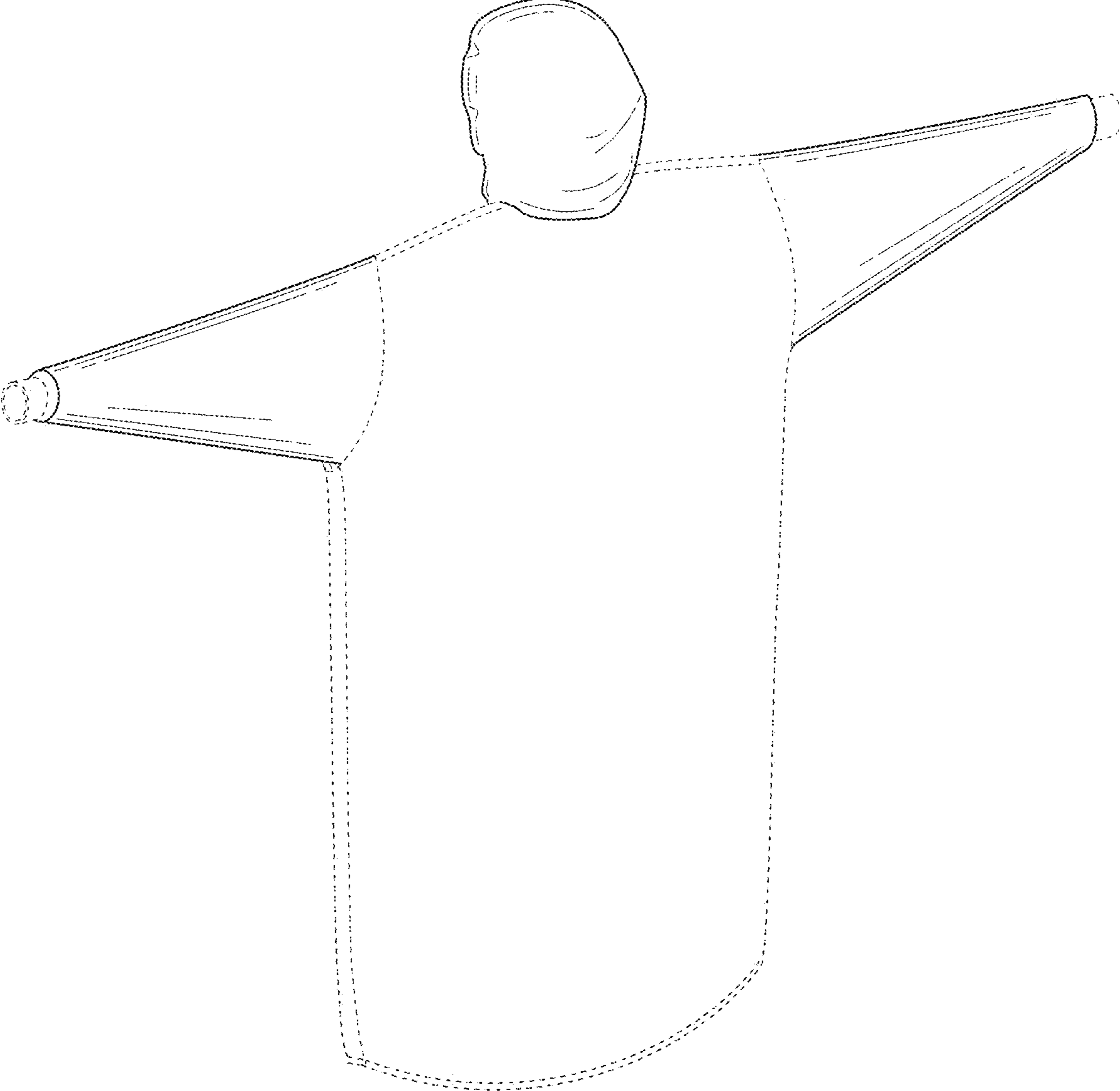

FIG. 18

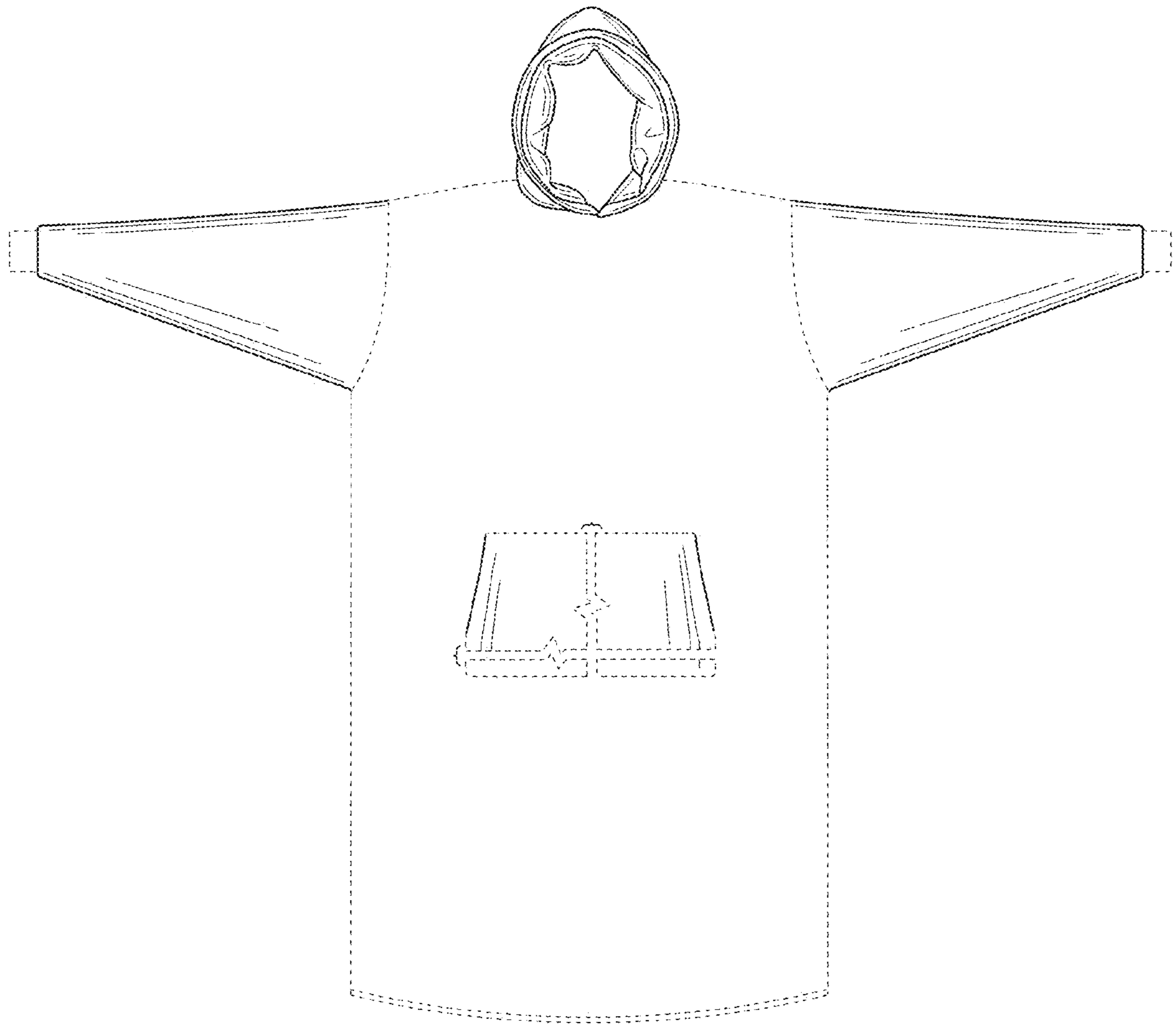

FIG. 19

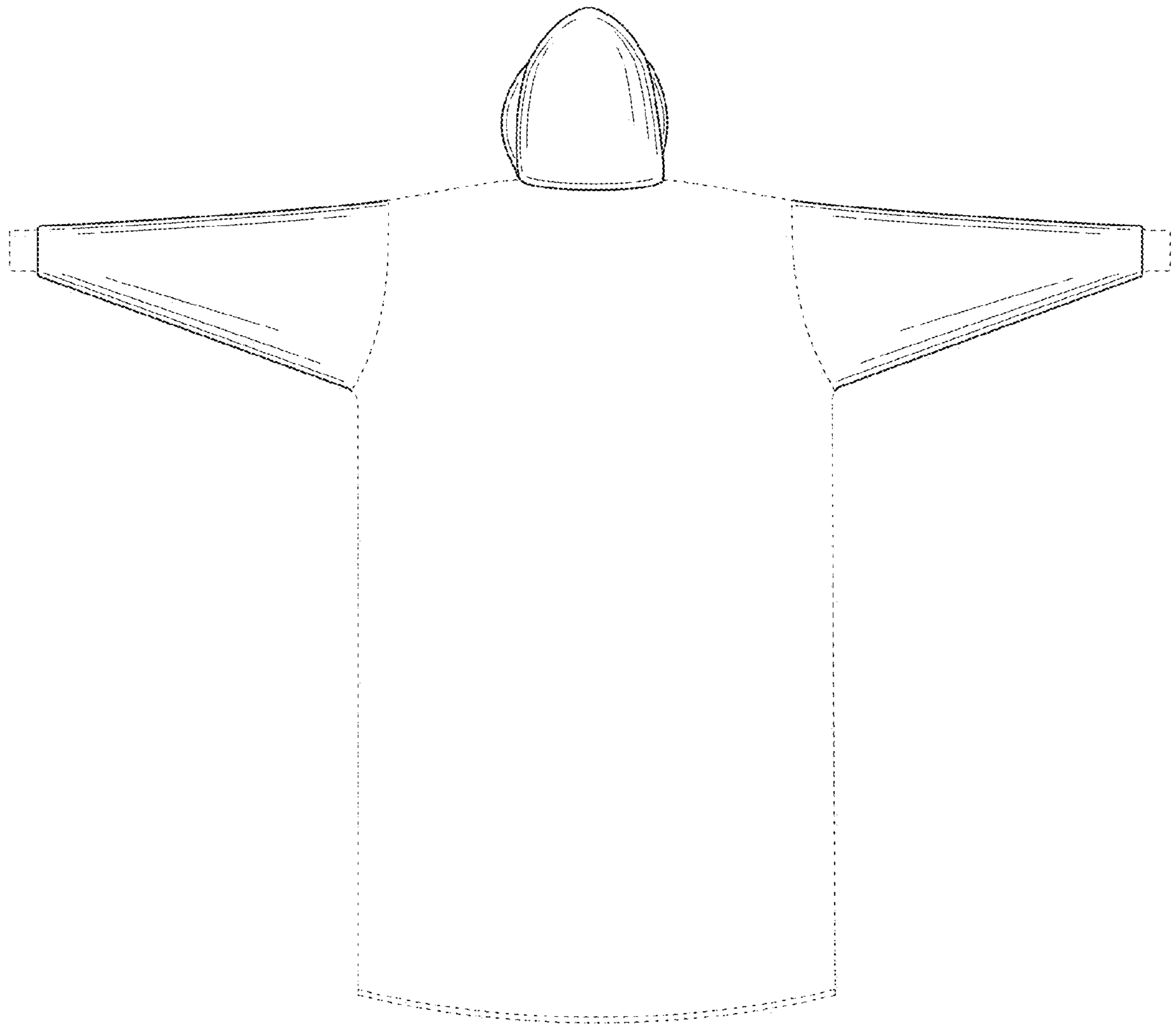

FIG. 20

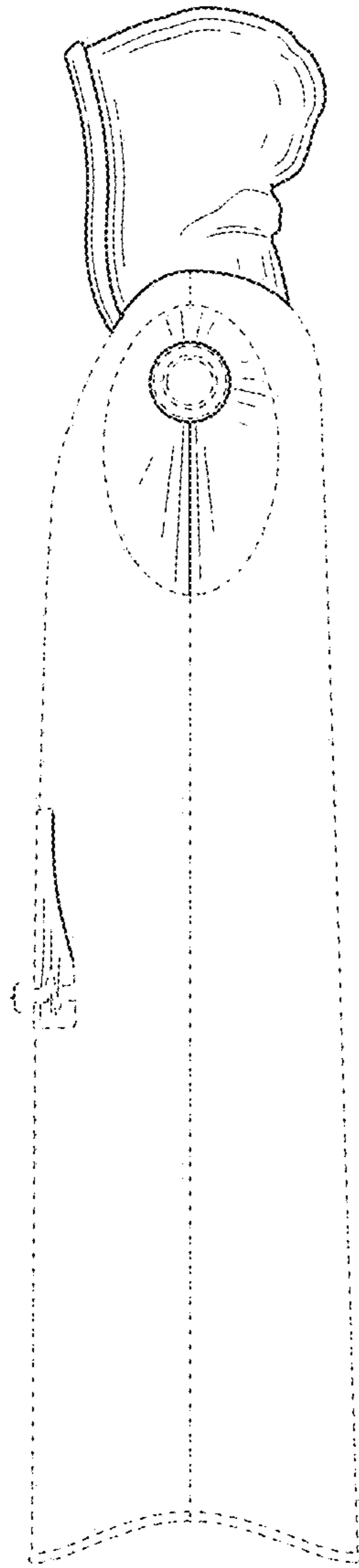

FIG. 21

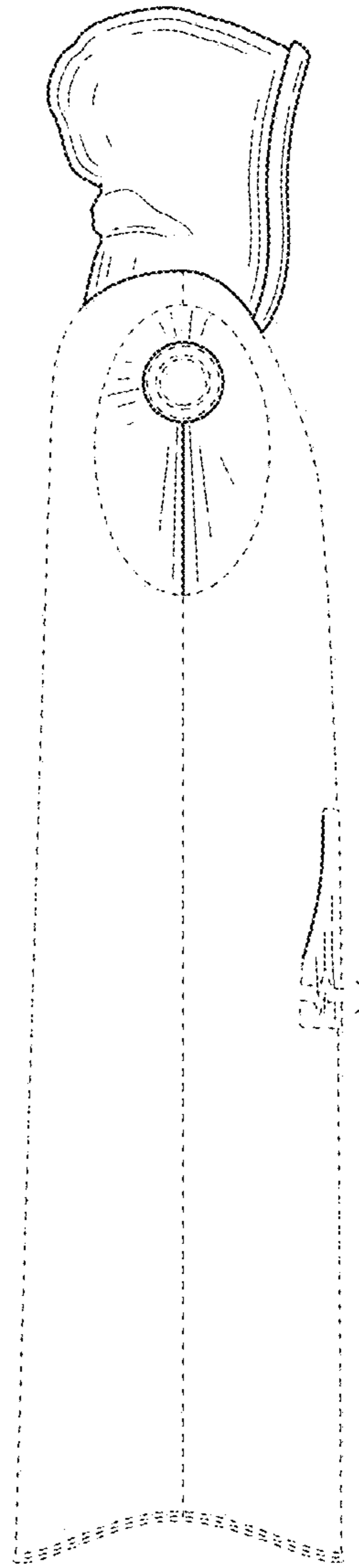

FIG. 22

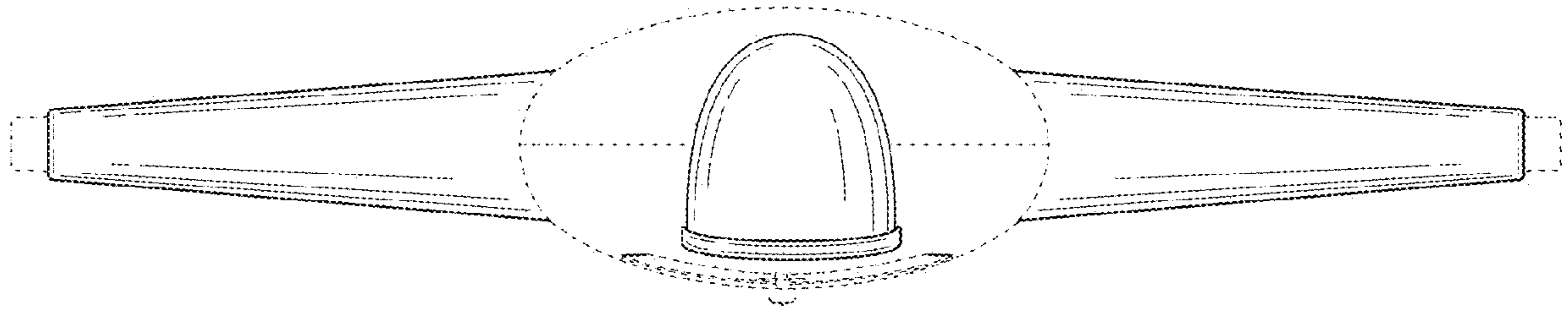

FIG. 23

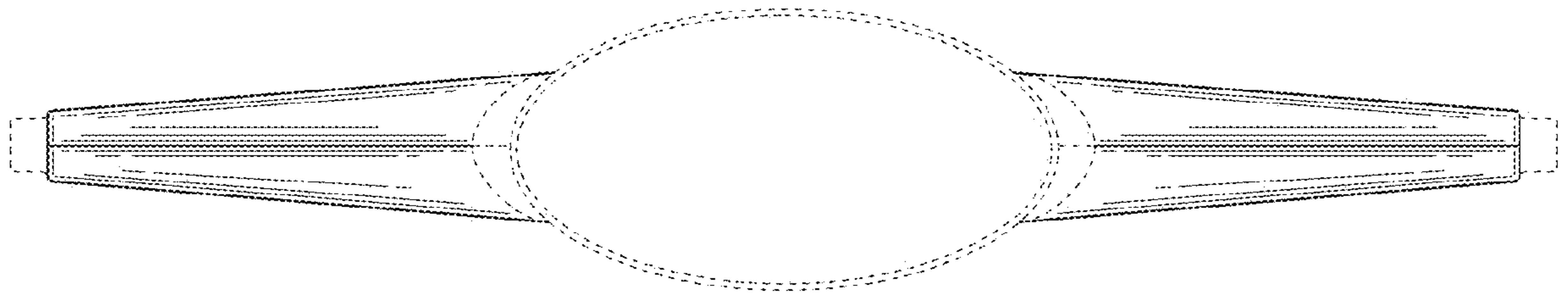

FIG. 24

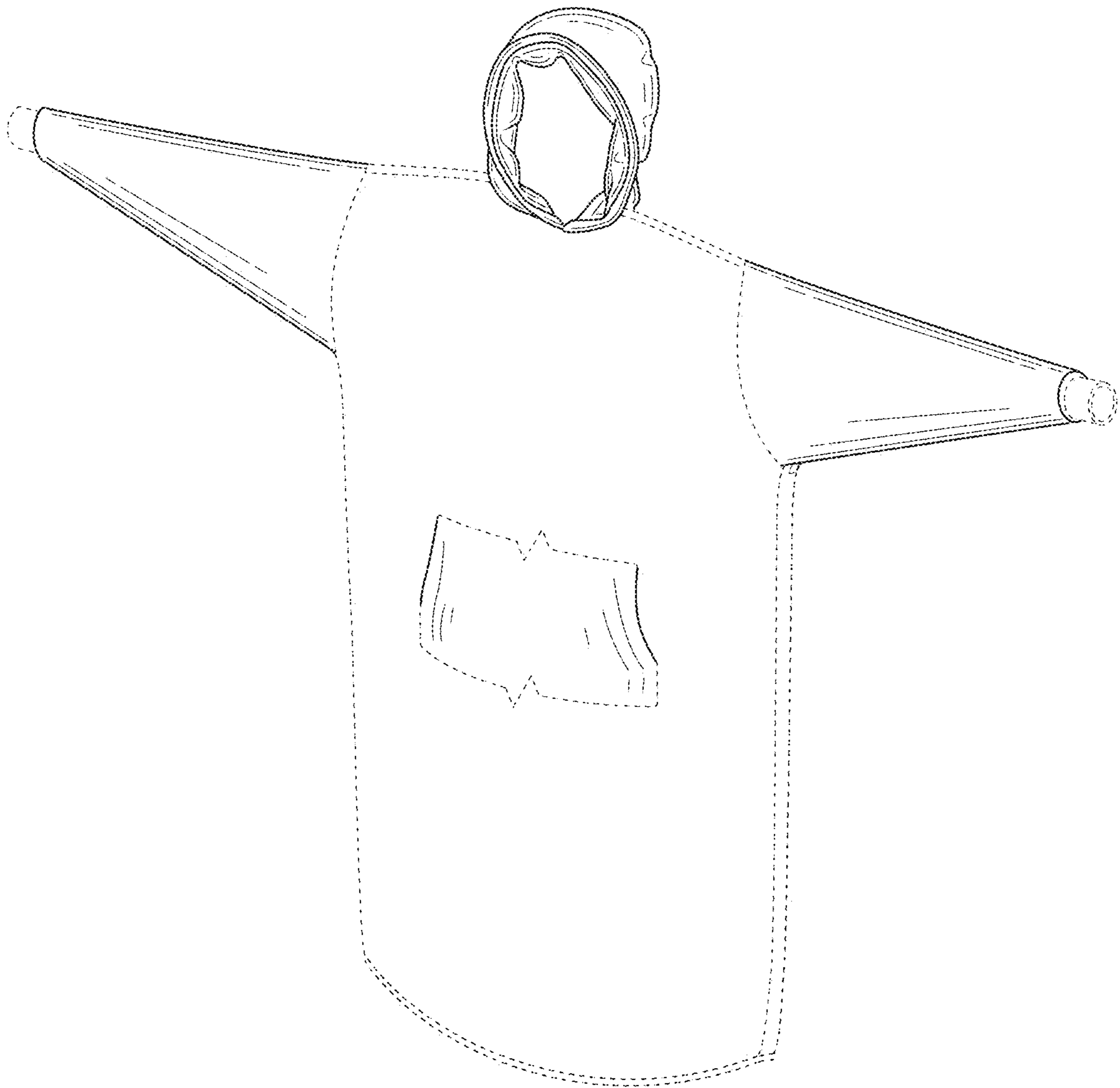

FIG. 25

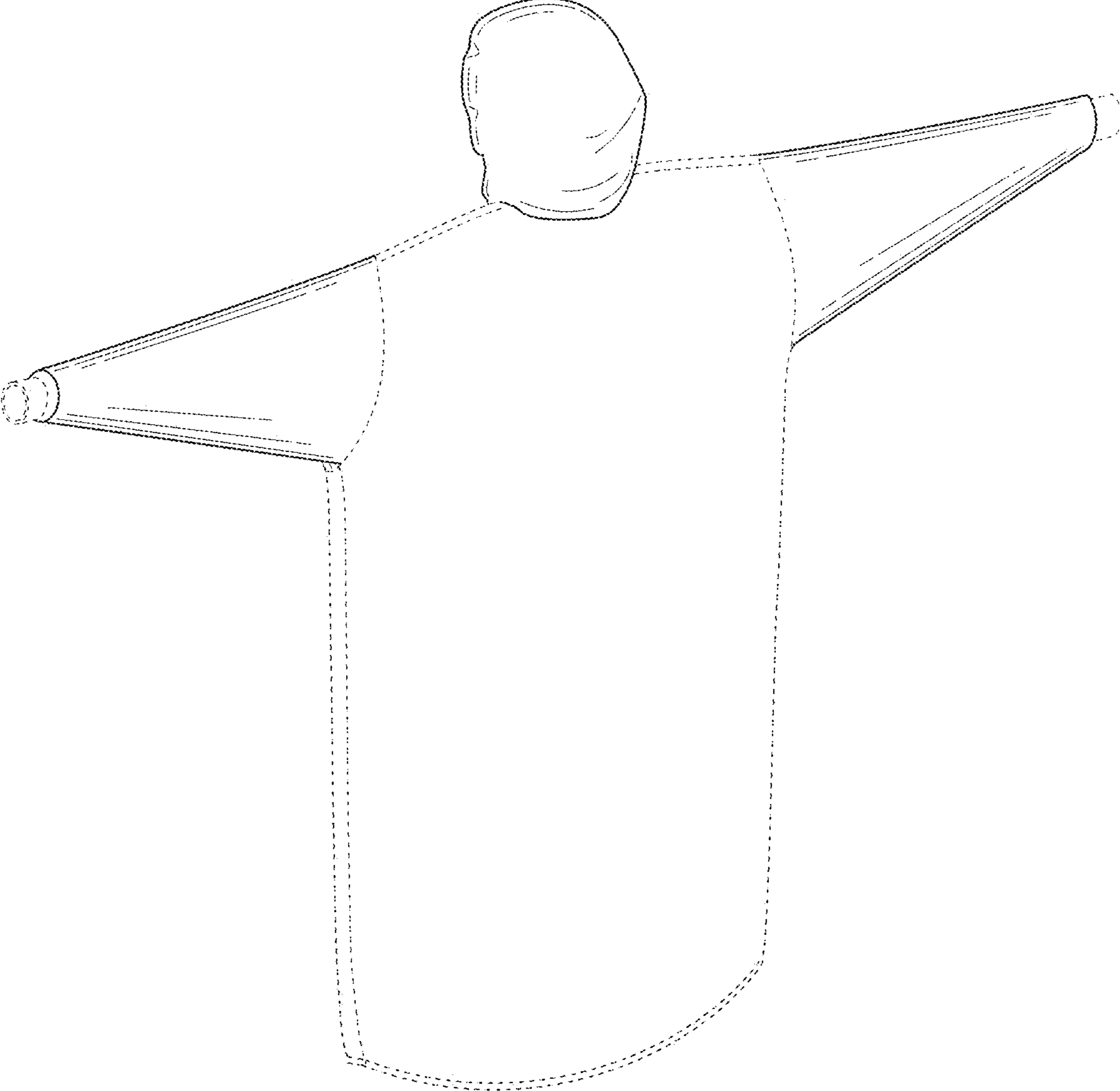

FIG. 26

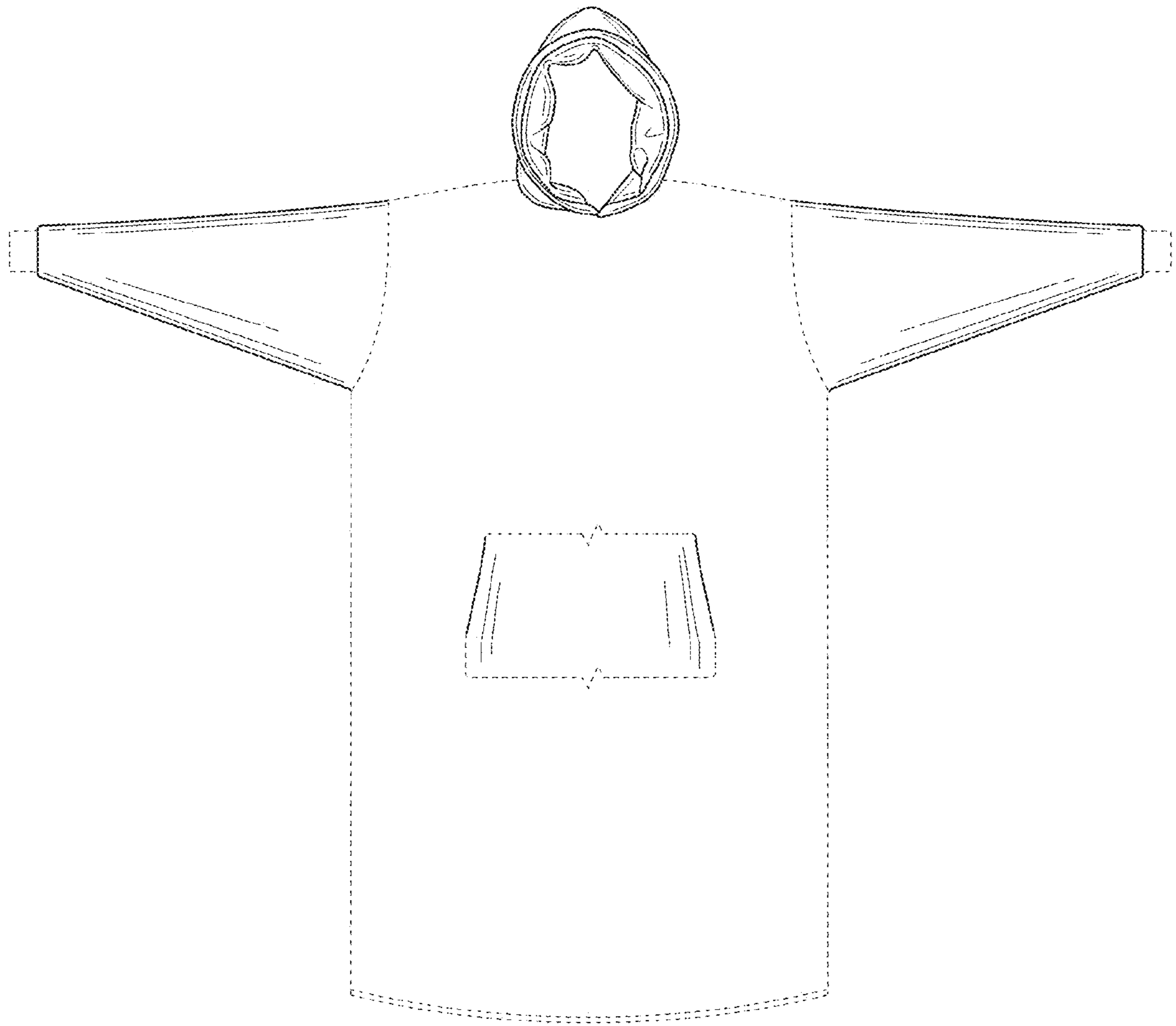

FIG. 27

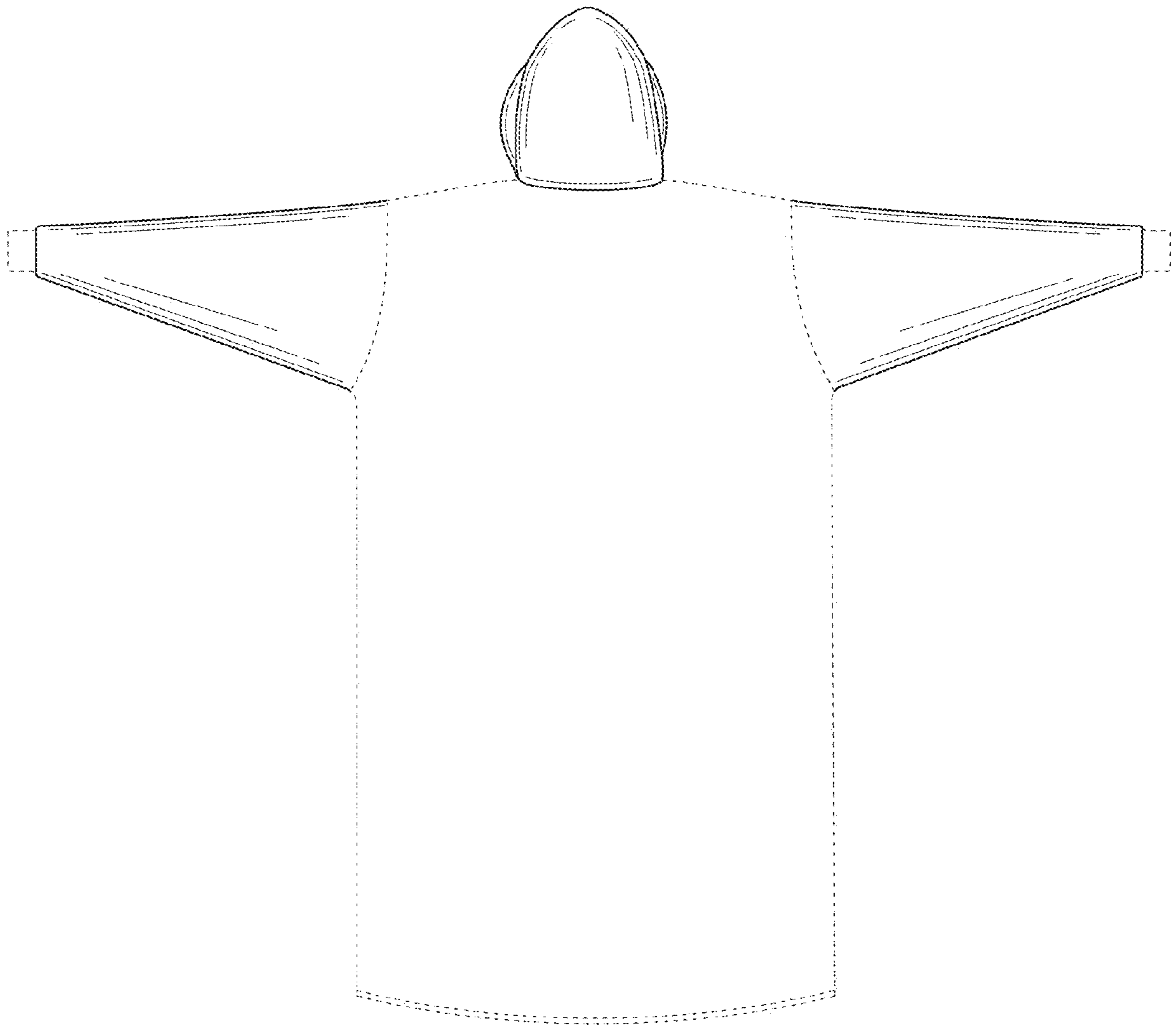

FIG. 28

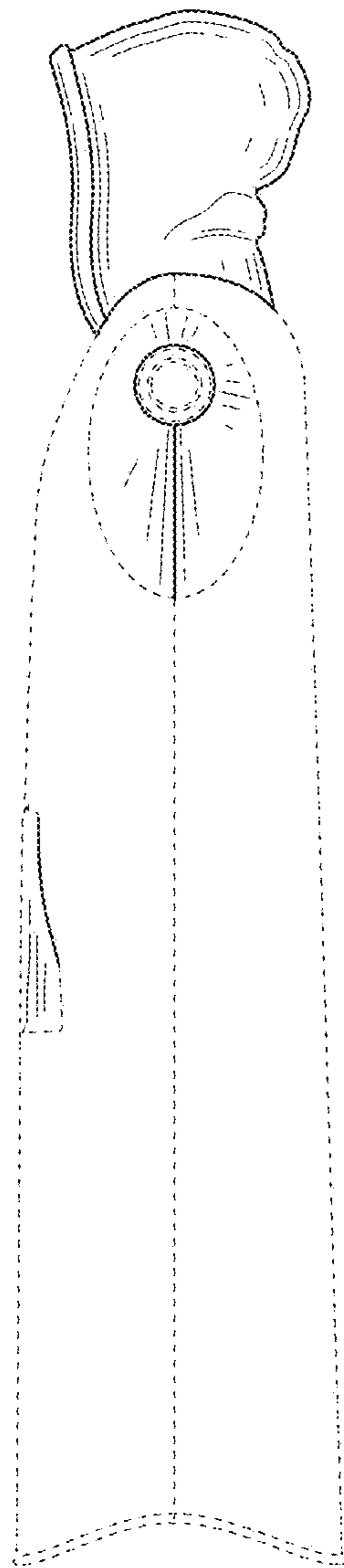

FIG. 29

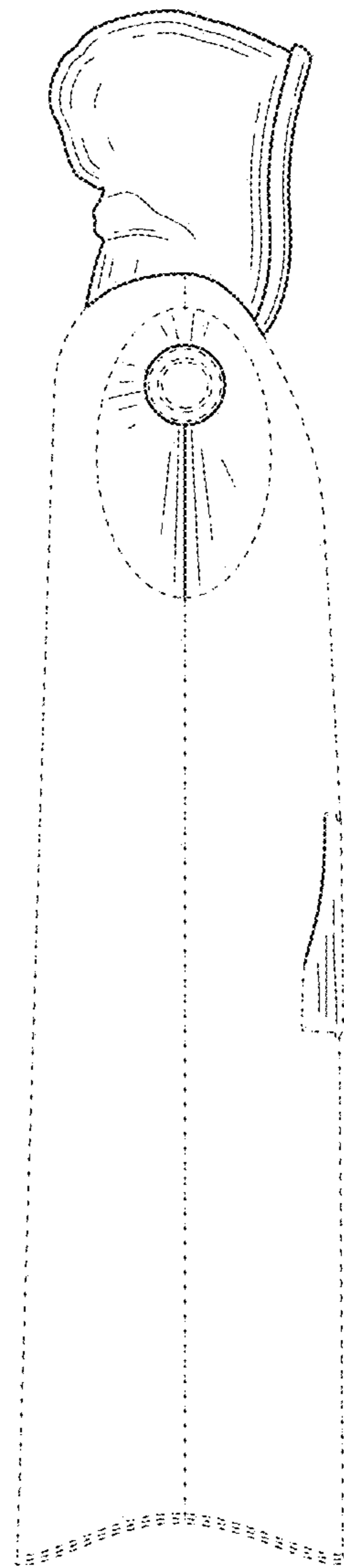

FIG. 30

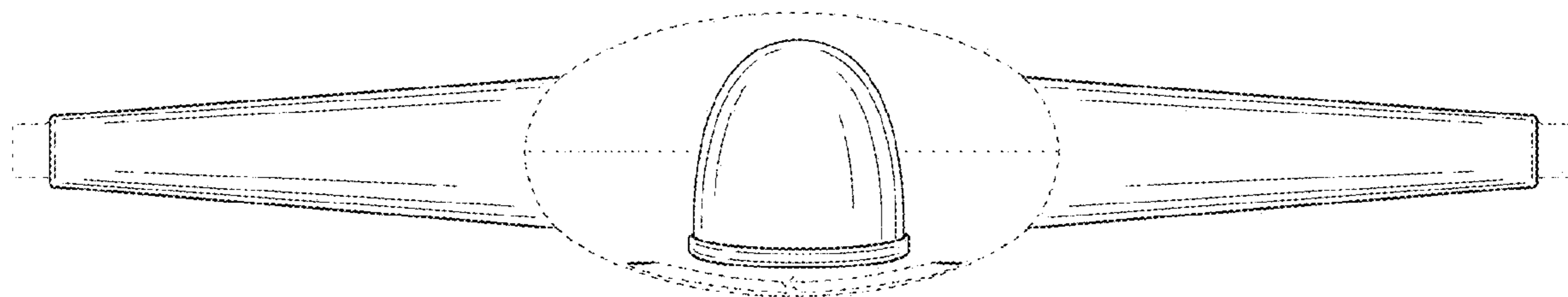

FIG. 31

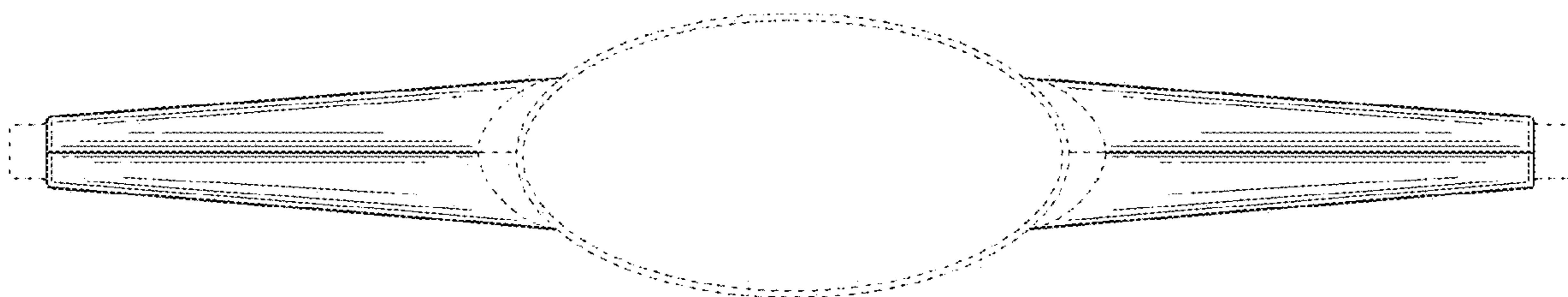

FIG. 32

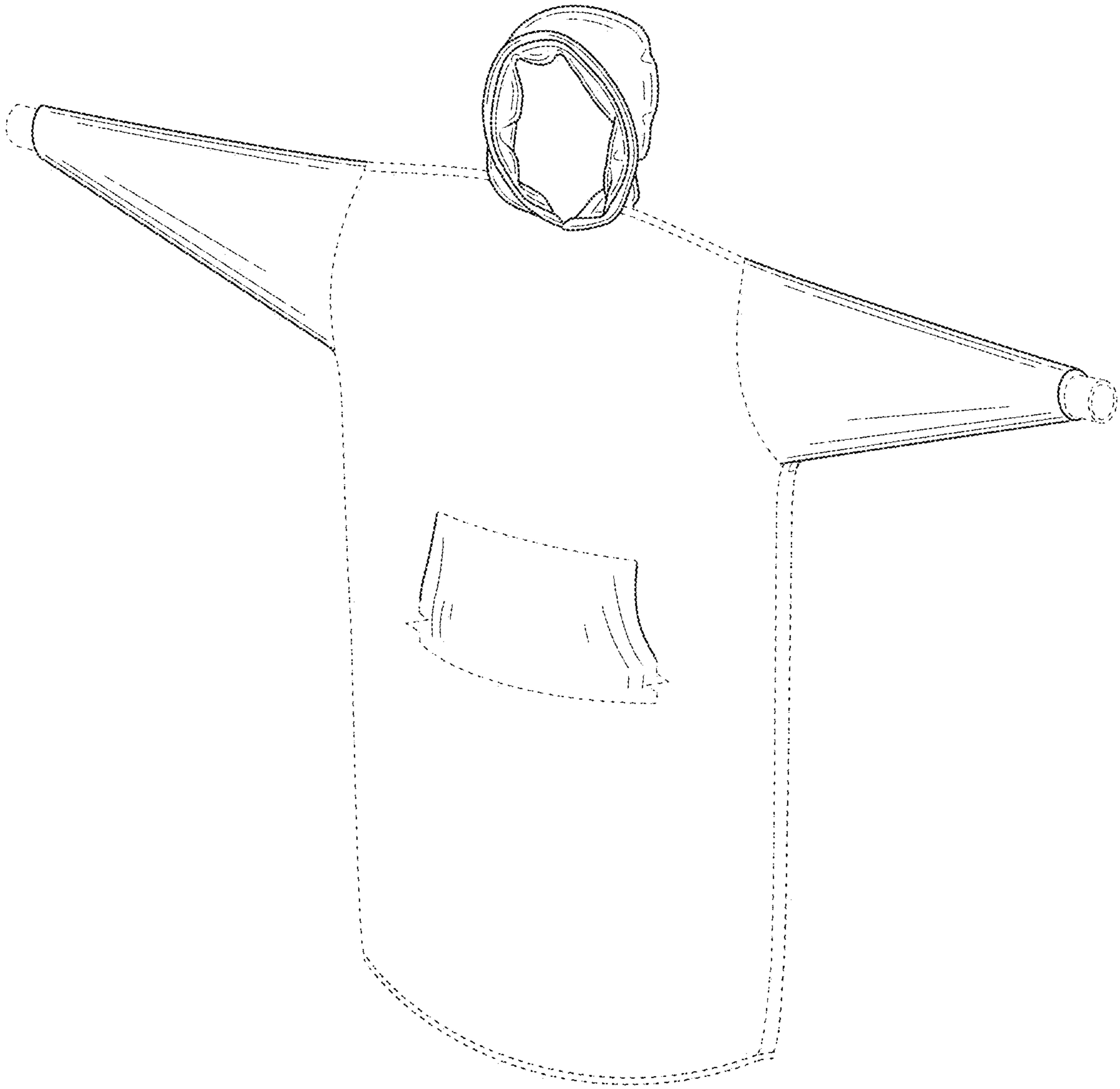

FIG. 33

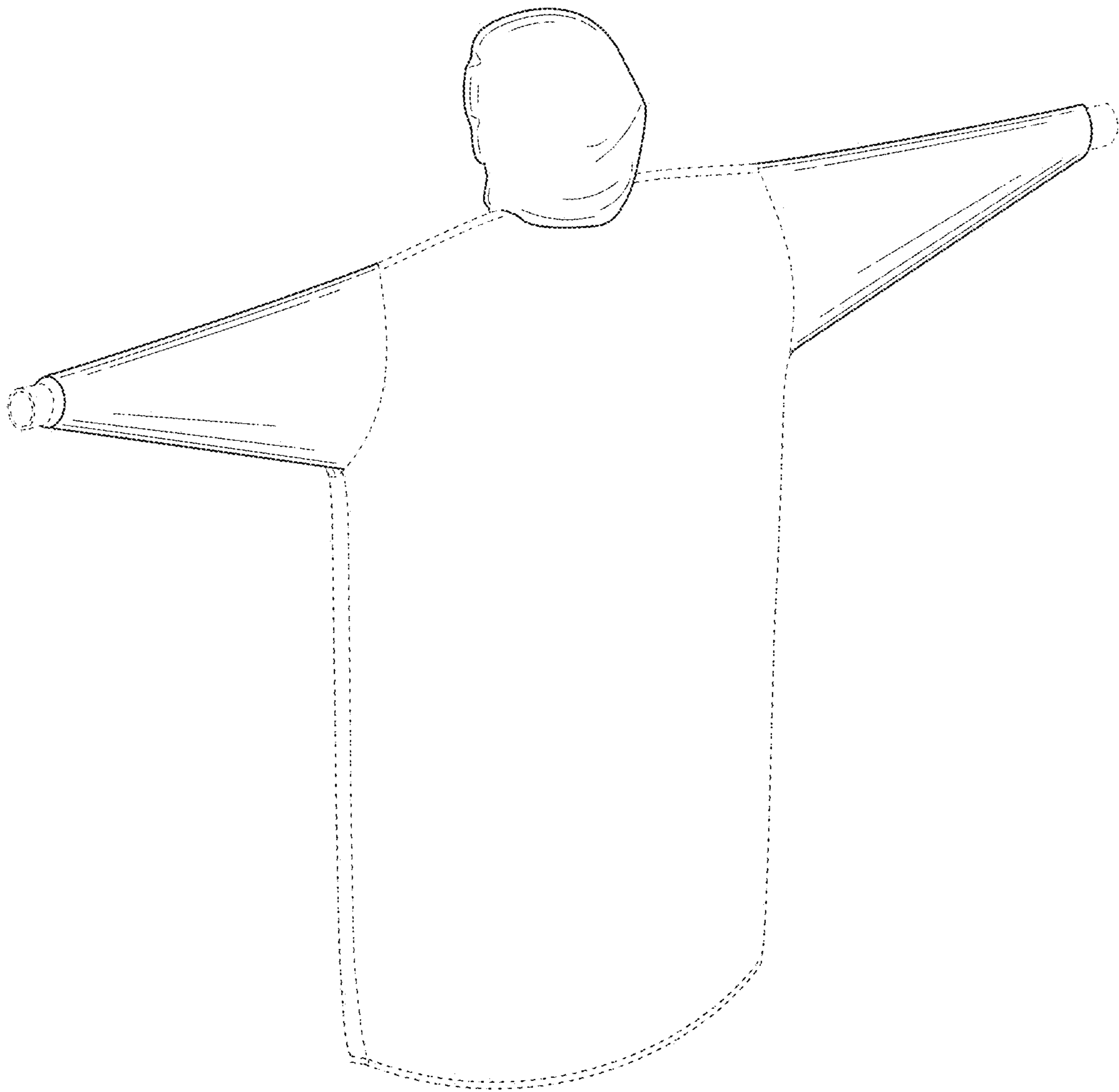

FIG. 34

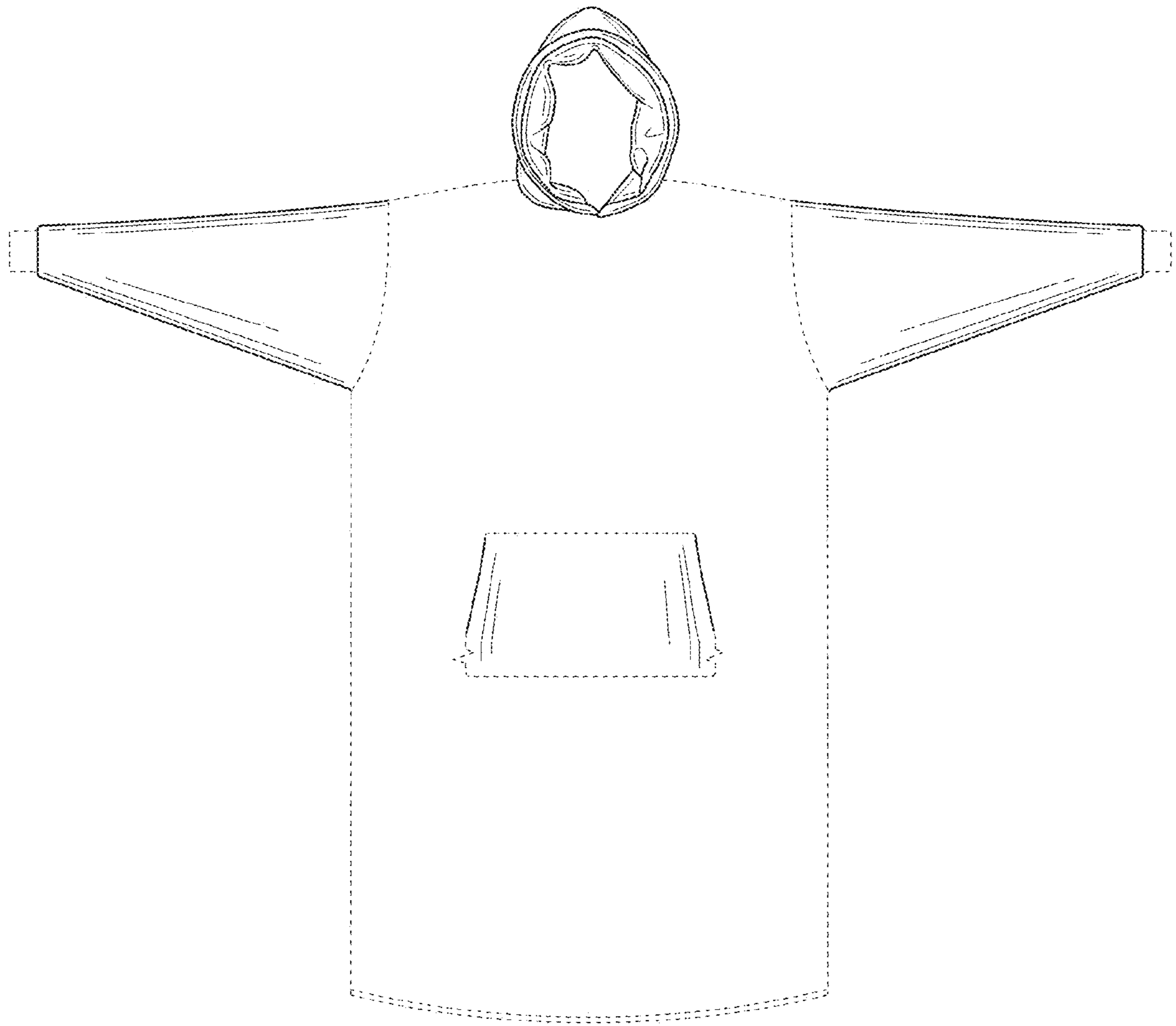

FIG. 35

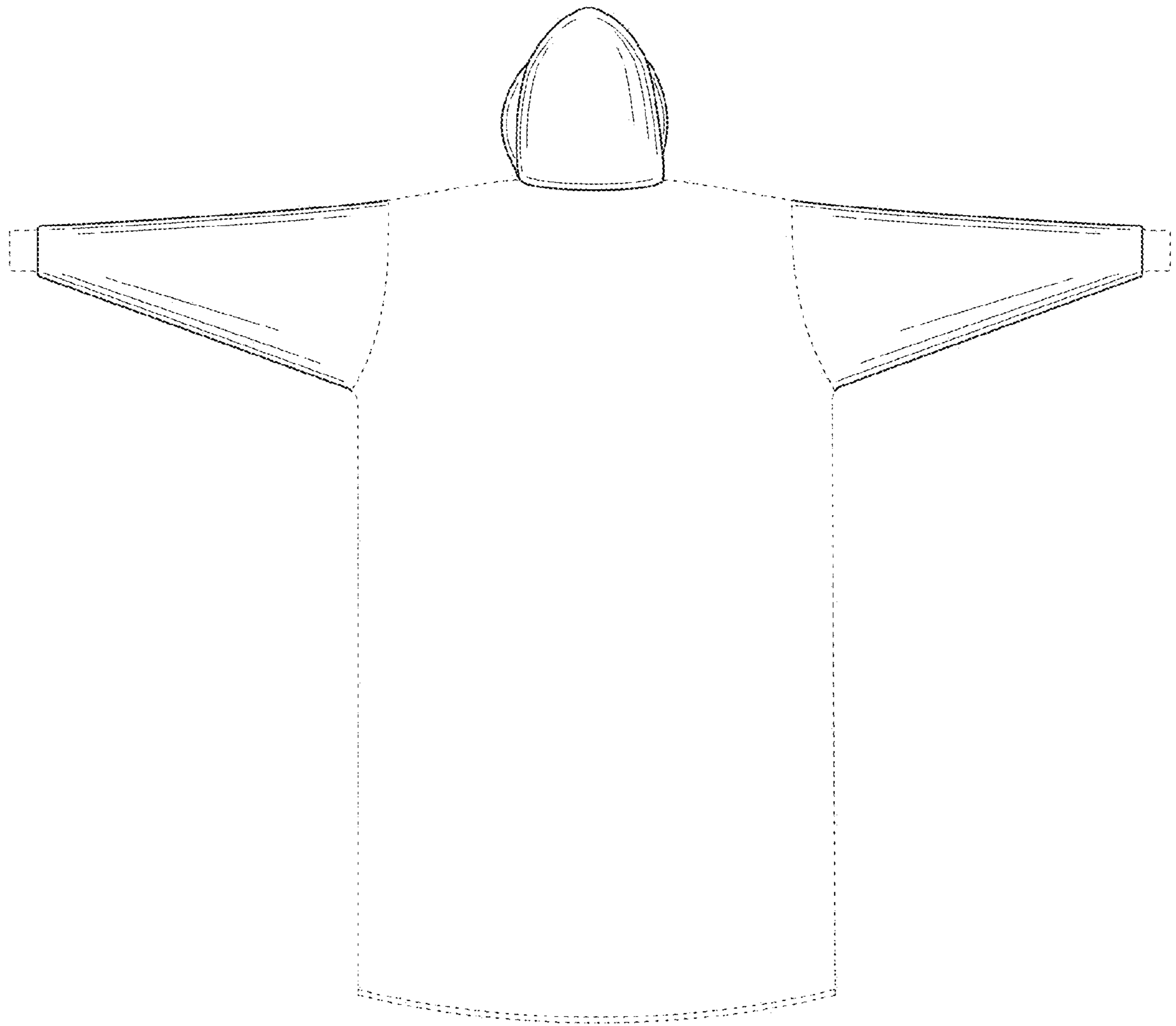

FIG. 36

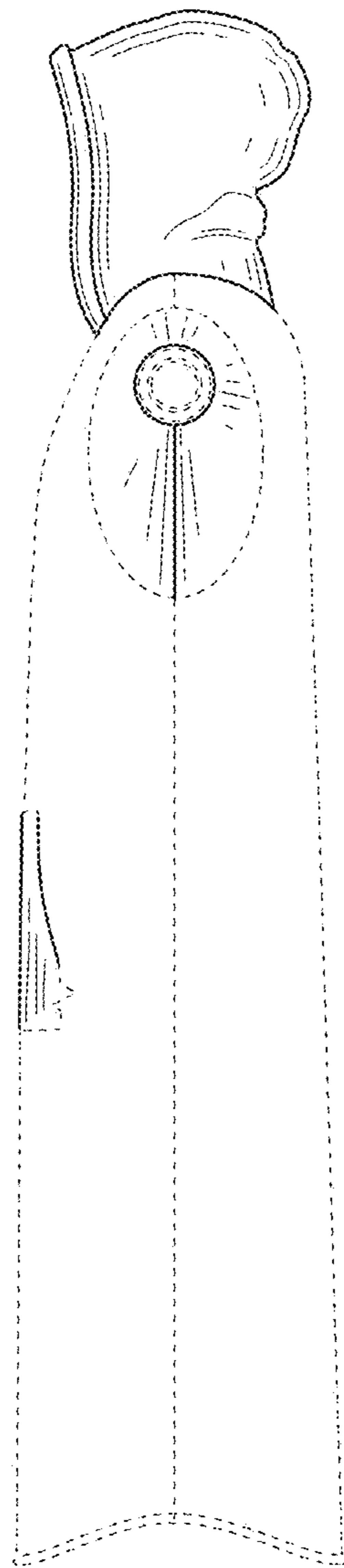

FIG. 37

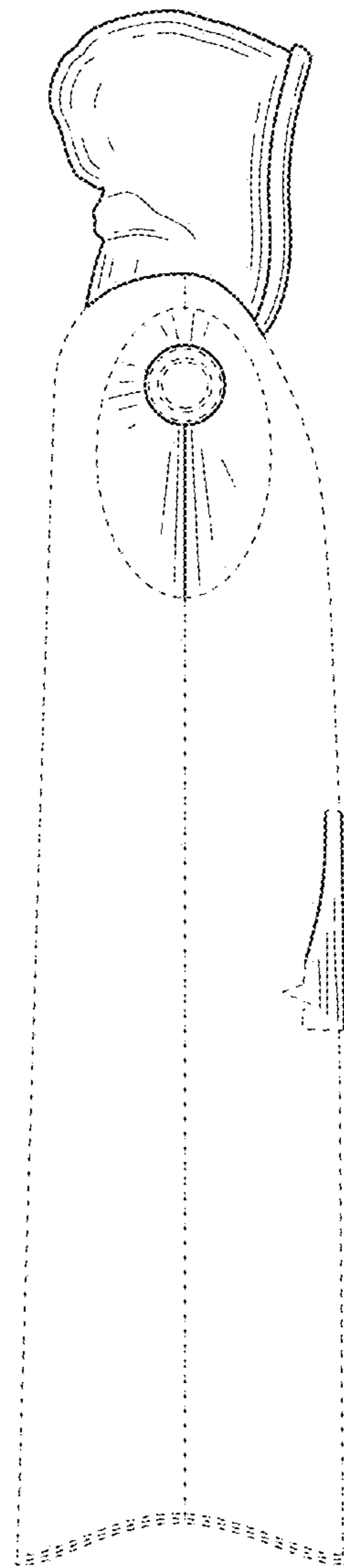

FIG. 38

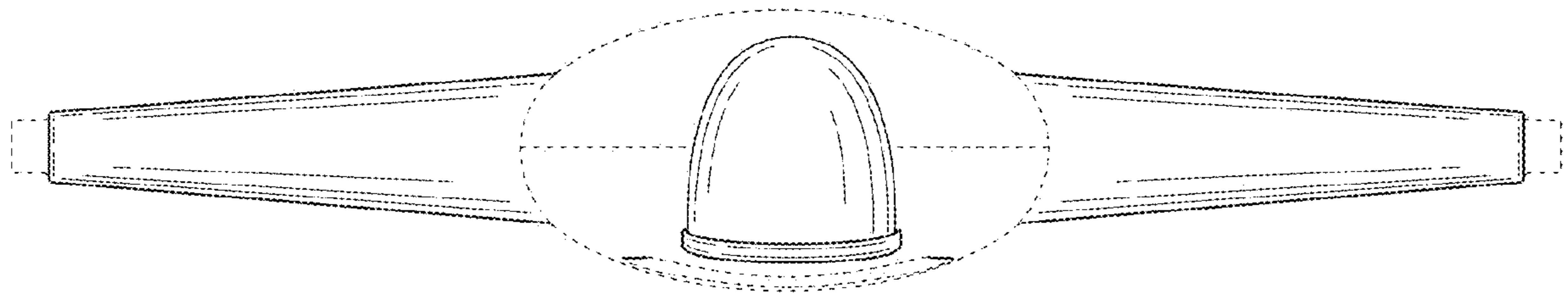

FIG. 39

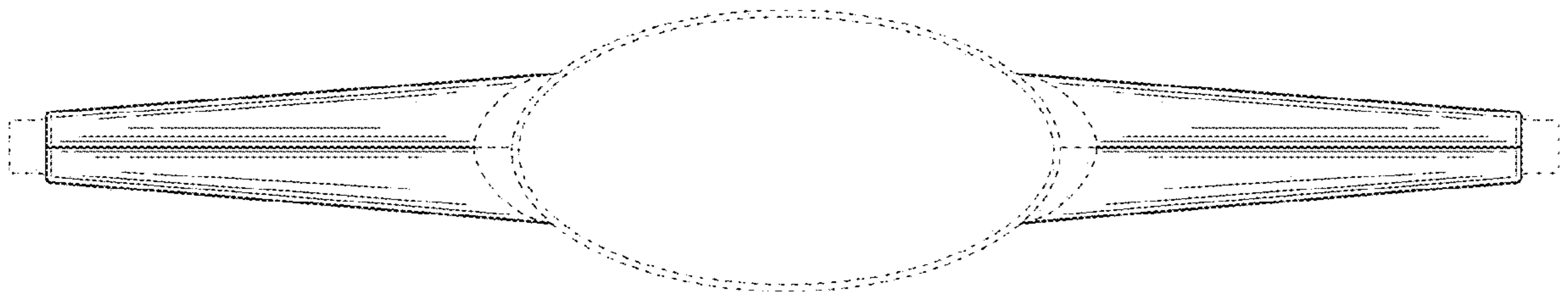

FIG. 40

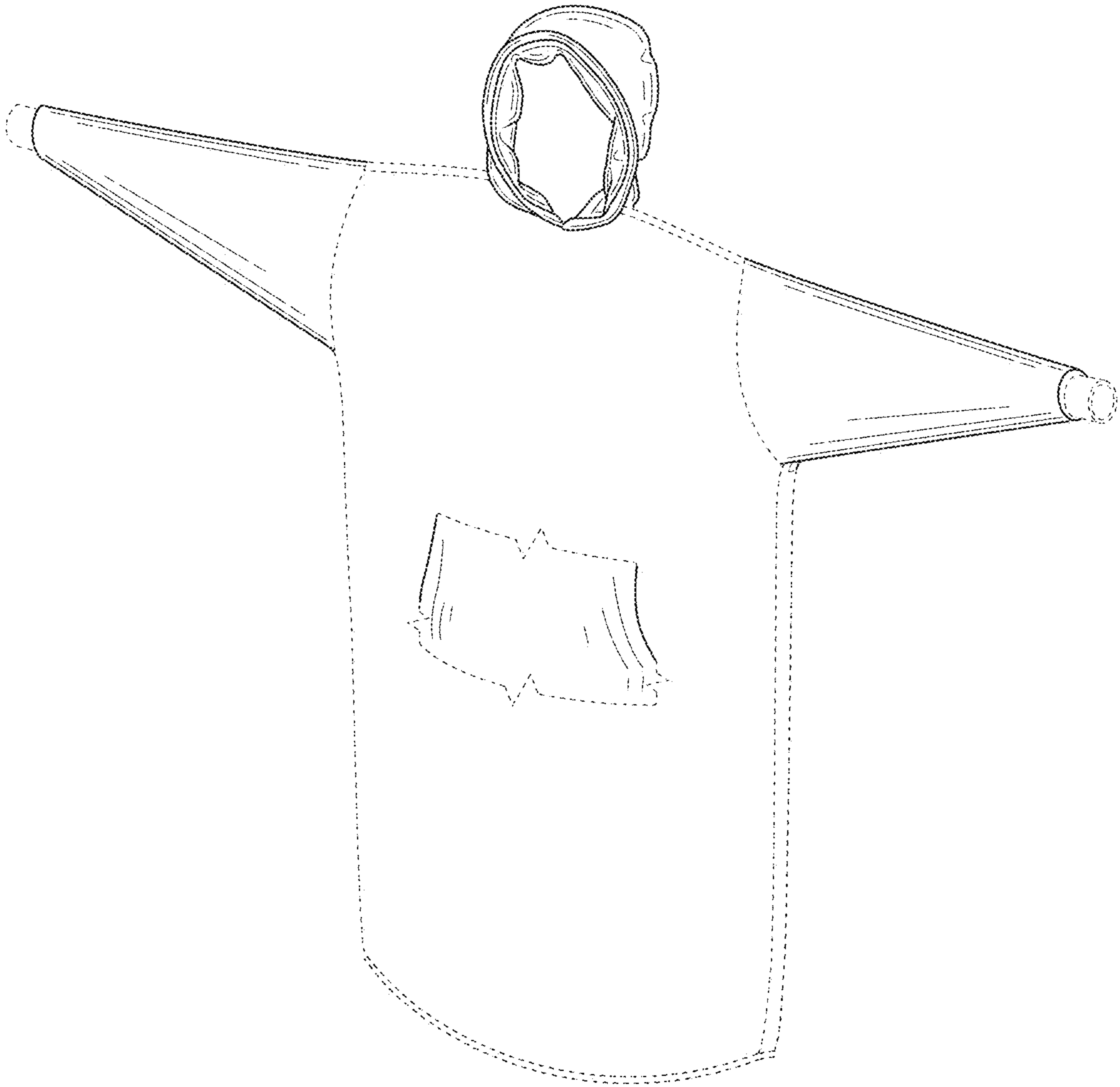

FIG. 41

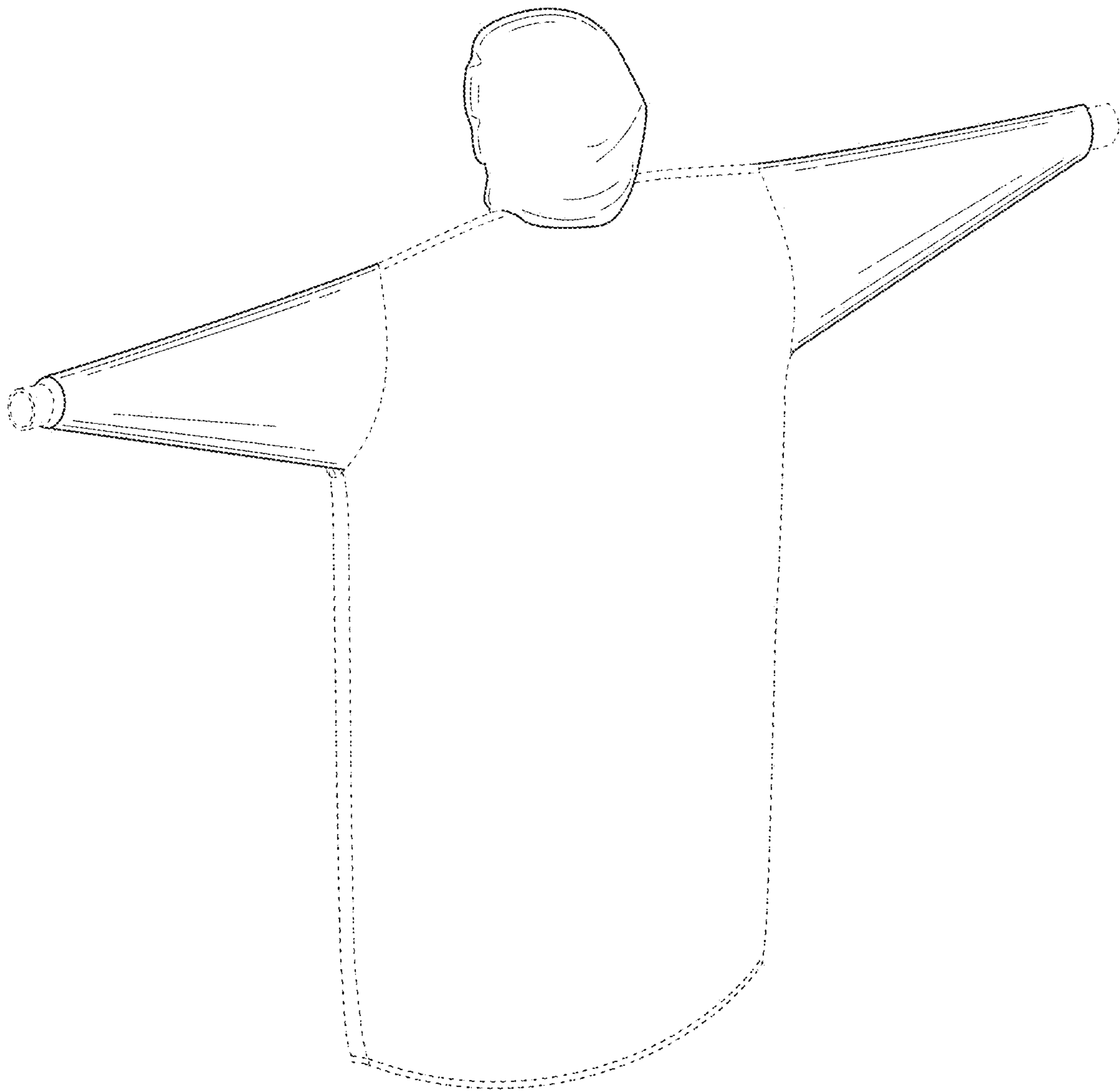

FIG. 42

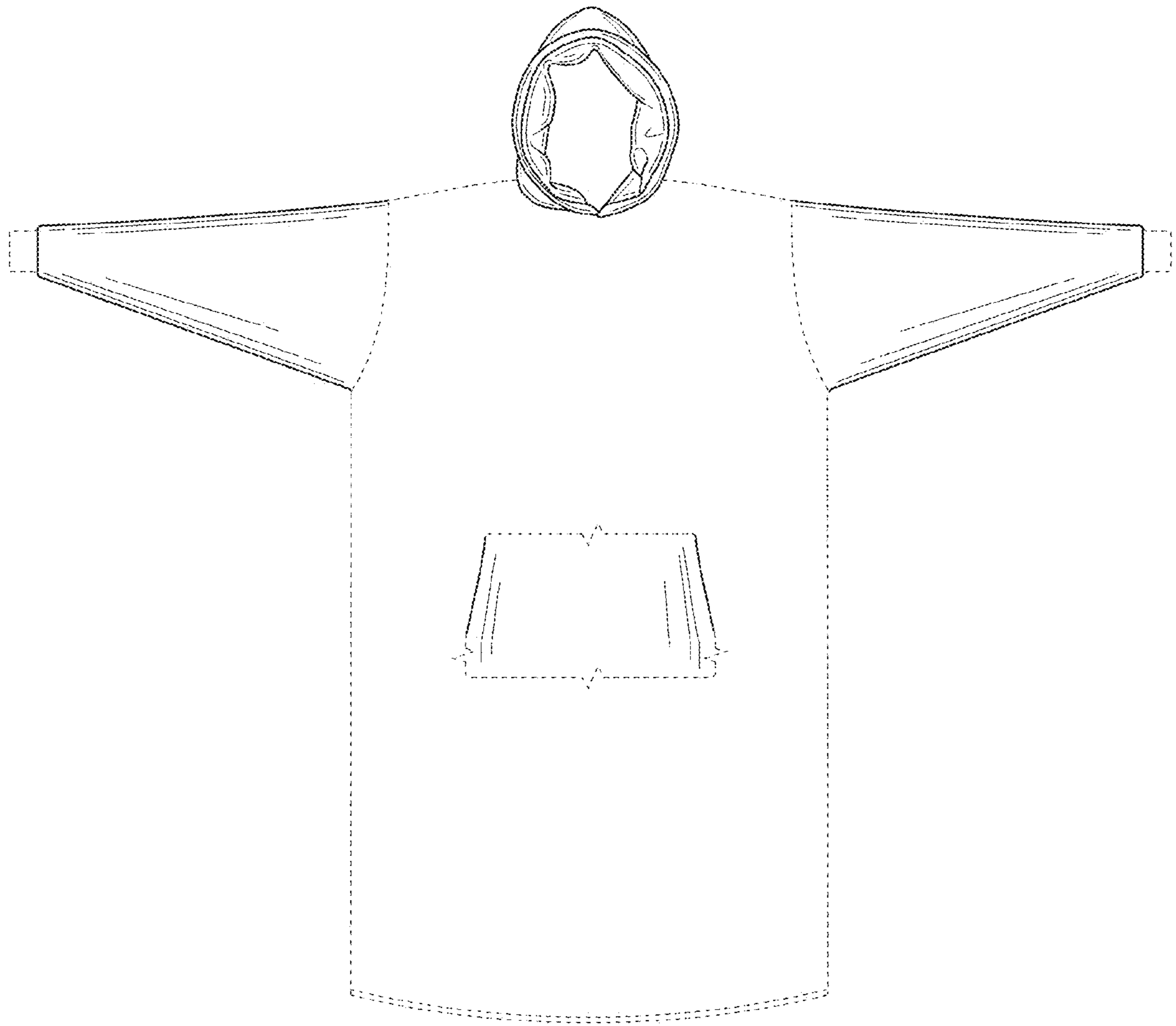

FIG. 43

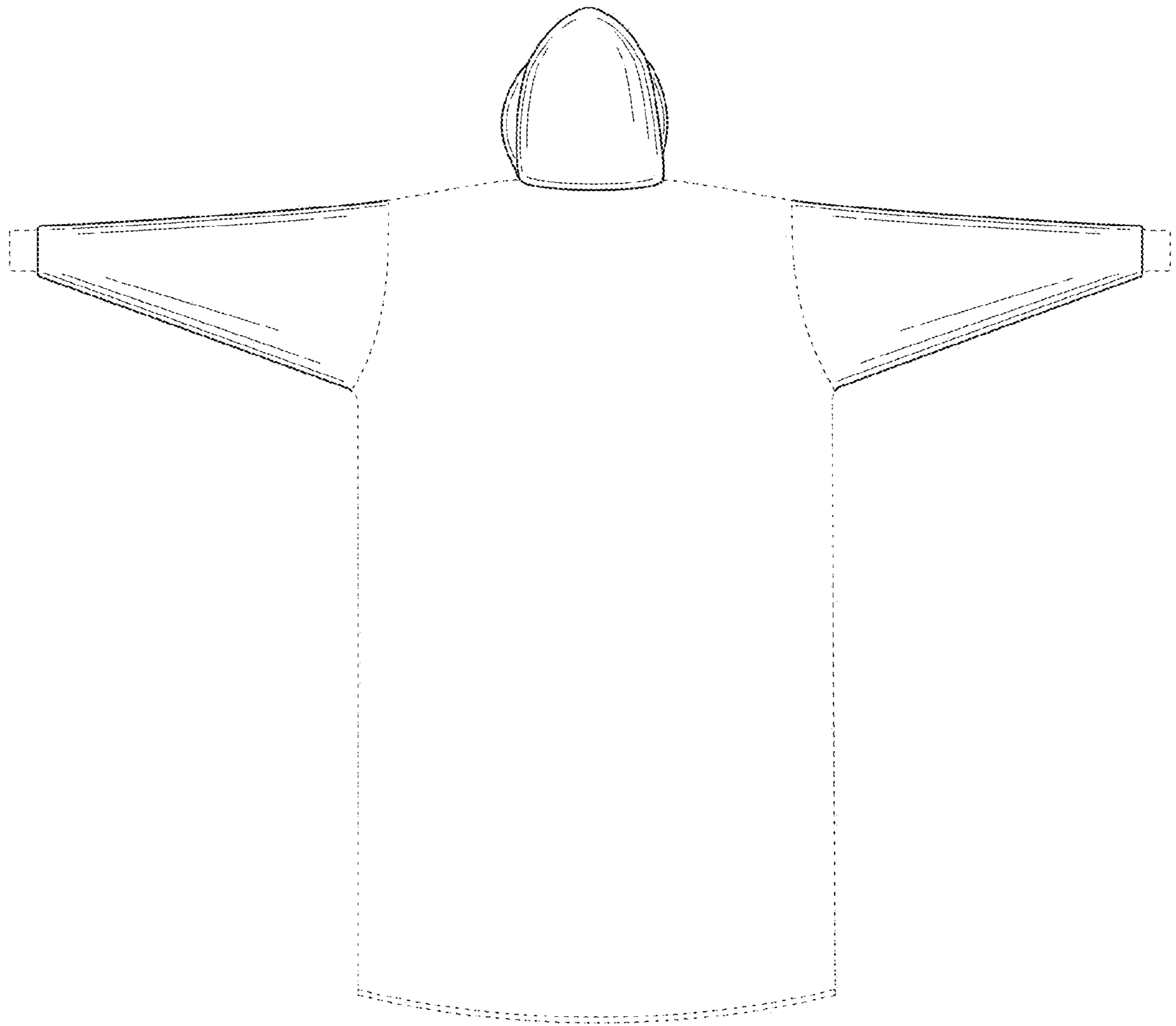

FIG. 44

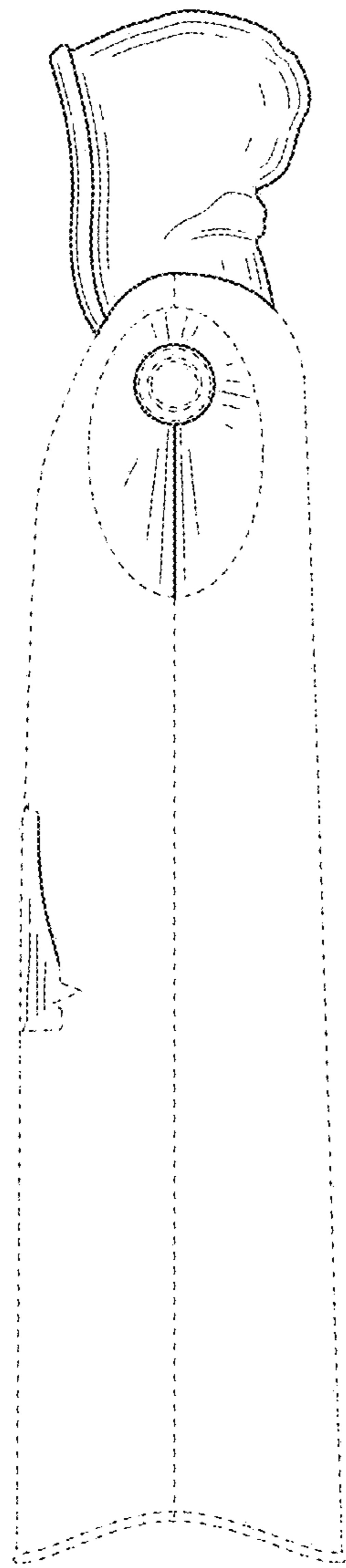

FIG. 45

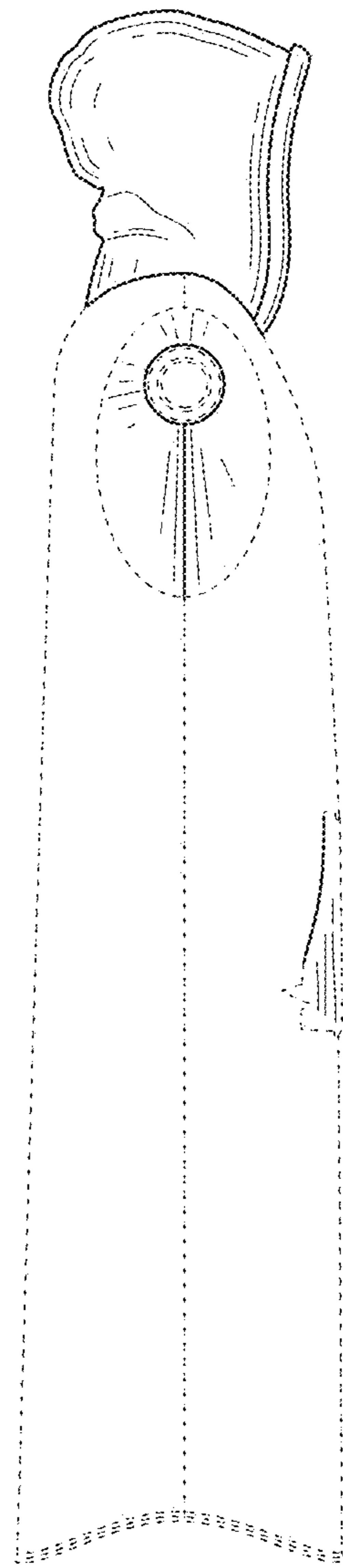

FIG. 46

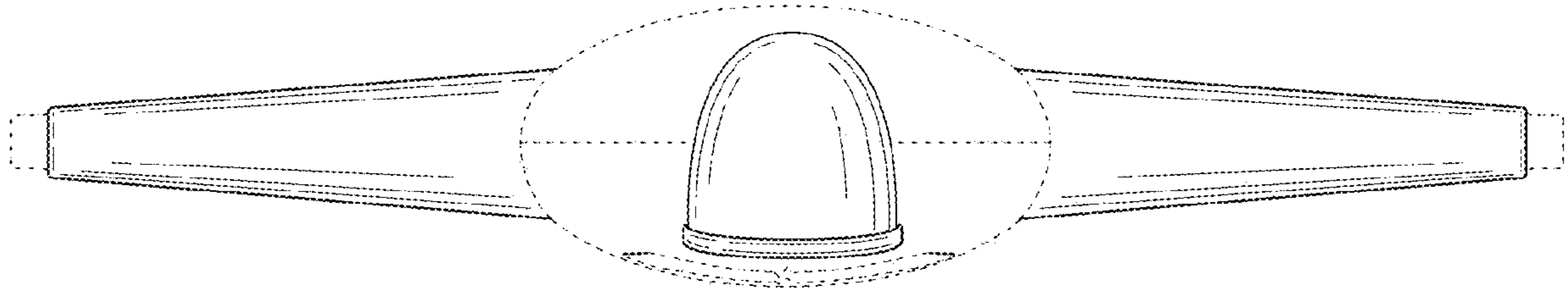

FIG. 47

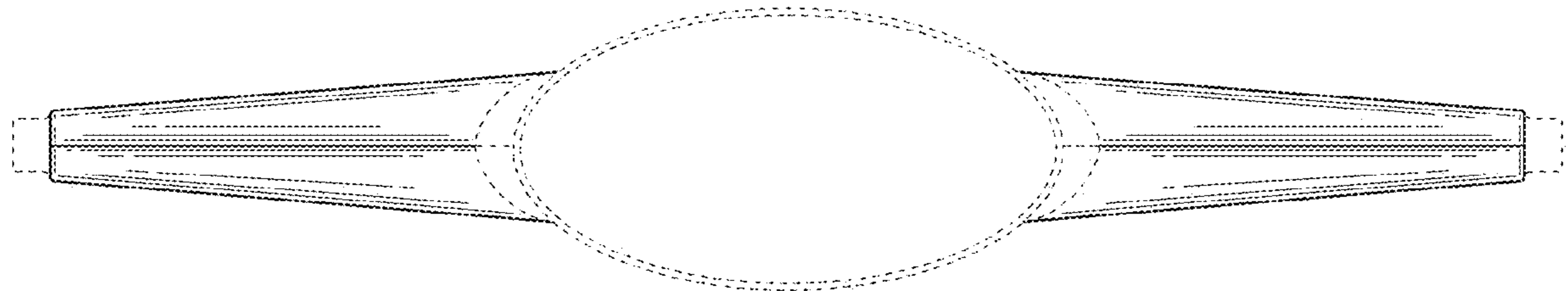

FIG. 48