



US00D967885S

(12) **United States Design Patent**
Huang

(10) **Patent No.:** **US D967,885 S**

(45) **Date of Patent:** **** Oct. 25, 2022**

(54) **CAMERA**

D824,984 S * 8/2018 Zhiyong D16/203
D830,443 S * 10/2018 Borel D16/203
D832,907 S * 11/2018 Jeong D16/203

(Continued)

(71) Applicant: **SHENZHEN SKYLINE SMART HOME CO., LTD.**, Shenzhen (CN)

(72) Inventor: **Wei Huang**, Shenzhen (CN)

(73) Assignee: **SHENZHEN SKYLINE SMART HOME CO., LTD.**, Shenzhen (CN)

FOREIGN PATENT DOCUMENTS

CN 305131826 * 4/2019
CN 306613007 * 6/2021
CN 307361747 * 5/2022

(**) Term: **15 Years**

OTHER PUBLICATIONS

(21) Appl. No.: **29/808,132**

“Pet Camera with Phone APP, 1080P Indoor Camera with 2-Way Talk, Night Vision Dog Camera, Sound/Motion Detect Alarm, Pan/Tilt/Zoom Pet Cam,SD/Cloud Storage Indoor Home Camera for Home Security Baby Cam” from Amazon.com, first available Mar. 21, 2022 from the internet<<https://www.amazon.com/dp/B09W2LJFZQ/>> (Year: 2022).*

(22) Filed: **Sep. 17, 2021**

(Continued)

(51) **LOC (13) Cl.** **16-01**

(52) **U.S. Cl.**

USPC **D16/202**

(58) **Field of Classification Search**

USPC D16/200–204, 205–211, 213, 217–219,
D16/237, 243; D10/46, 50, 52, 104.1,
D10/106.6, 106.7, 114.8; D14/203.1,
D14/204, 317, 474, 496, 510

CPC G03B 17/00; G03B 17/02; G03B 2217/00;
H04N 5/2251; H04N 5/2252; H04N
5/22525

See application file for complete search history.

Primary Examiner — Elizabeth J Oswecki
Assistant Examiner — Lacey Chey Bowman

(57)

CLAIM

The ornamental design for a camera, as shown and described.

DESCRIPTION

FIG. 1 is a top, front perspective view of a camera showing my new design;

FIG. 2 is a bottom, rear perspective view thereof;

FIG. 3 is a front elevational view thereof;

FIG. 4 is a rear elevational view thereof;

FIG. 5 is a left side elevational view thereof;

FIG. 6 is a right side elevational view thereof;

FIG. 7 is a top plan view thereof;

FIG. 8 is a bottom plan view thereof; and,

FIG. 9 is another perspective view thereof, shown in a used condition.

The broken lines in the drawings depict portions of the camera that form no part of the claimed design.

(56)

References Cited

U.S. PATENT DOCUMENTS

D340,253 S * 10/1993 Fedorcak 348/143
D500,067 S 12/2004 Liu
D550,738 S * 9/2007 Hsia D16/202
D552,650 S * 10/2007 Yamakawa D16/203
D753,204 S * 4/2016 Luo D16/202
D783,076 S * 4/2017 Ravat D16/203
D790,620 S * 6/2017 Lee D16/202
D810,804 S * 2/2018 Borel D16/203
D813,290 S * 3/2018 Song D16/203
D813,926 S * 3/2018 Shin D16/203
D820,337 S * 6/2018 Li D16/203

1 Claim, 9 Drawing Sheets

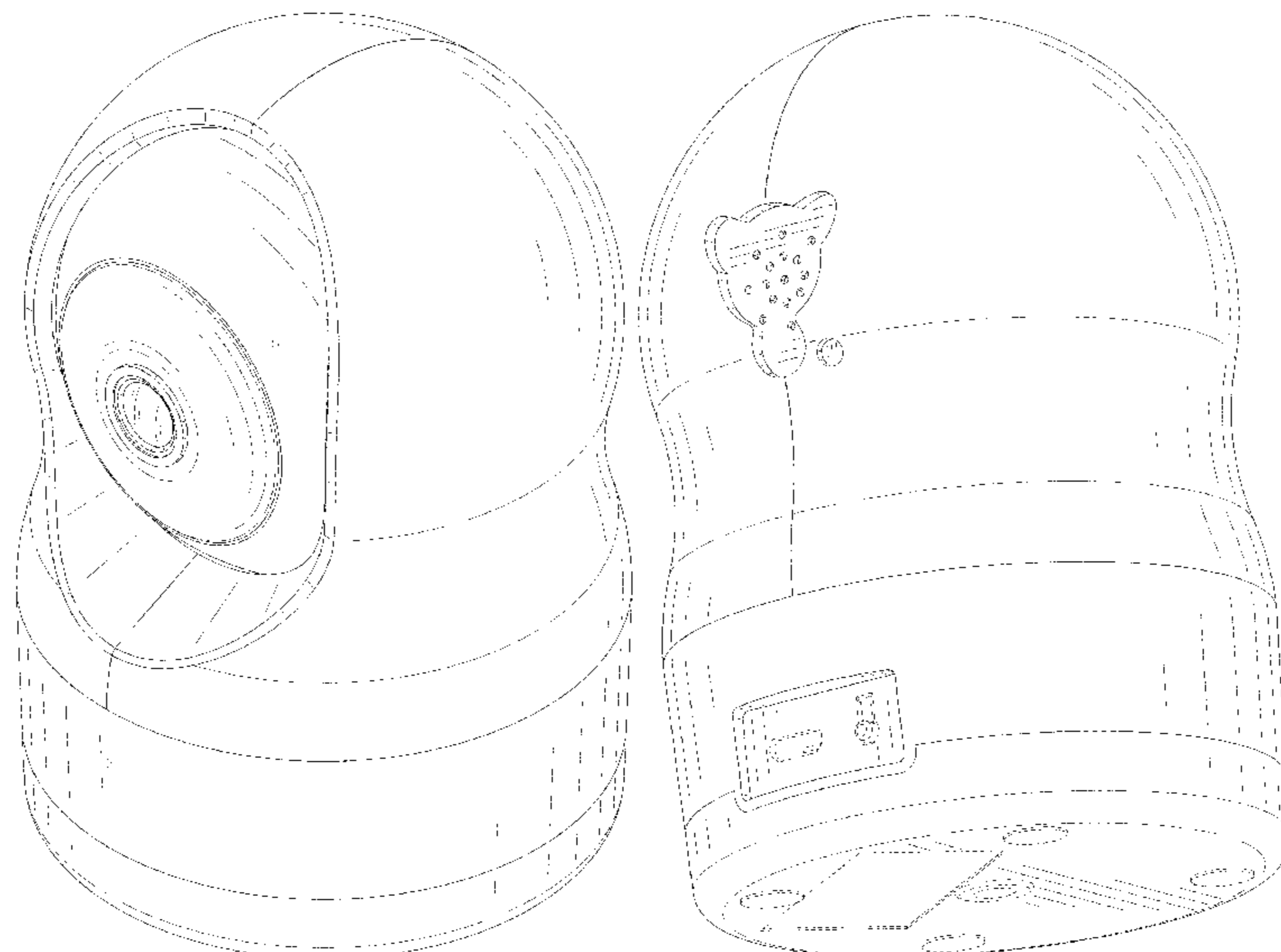

(56)

References Cited

U.S. PATENT DOCUMENTS

D836,698 S * 12/2018 Hathway D16/202
 D849,094 S * 5/2019 Gan D16/203
 D861,762 S * 10/2019 Gan D16/203
 D866,635 S * 11/2019 Zhong D16/203
 D867,425 S * 11/2019 Shuai D16/203
 D883,357 S * 5/2020 Moon D16/203
 D884,052 S * 5/2020 Tang D16/203
 D884,768 S * 5/2020 Liu D16/203
 D890,831 S * 7/2020 Zheng D16/203
 D898,097 S * 10/2020 Ravat D16/203
 D898,800 S * 10/2020 Zeng D16/203
 D901,572 S * 11/2020 Wang D16/203
 D911,413 S * 2/2021 Yamazaki D16/202
 D916,165 S * 4/2021 Wang D16/203
 D918,982 S 5/2021 Dan
 D921,085 S * 6/2021 Li D16/203
 D926,242 S * 7/2021 Lu D16/203
 D933,732 S * 10/2021 Yamada D16/202
 D934,941 S * 11/2021 Cheng D16/203
 D936,722 S * 11/2021 Yu D16/202
 D937,924 S * 12/2021 Dong D16/203
 D939,007 S * 12/2021 Wei D16/203
 D943,656 S * 2/2022 Chen D16/203

11,252,309 B1 * 2/2022 Zhang H04N 5/2254
 D947,270 S * 3/2022 Yamazaki D16/202
 2007/0041726 A1 * 2/2007 Lee G08B 13/1963
 396/427
 2008/0008467 A1 * 1/2008 Liu H04N 5/2251
 396/427

OTHER PUBLICATIONS

“Eufy Security Solo IndoorCam P24, 2K, Pan & Tilt, Indoor Security Camera, Wi-Fi Plug-in Camera, Human & Pet AI, Voice Assistant Compatibility, Night Vision, Motion Tracking, HomeBase not Compatible” from Amazon.com, first available Feb. 26, 2020 from the internet <<https://www.amazon.com/eufy-Security-Assistant-Compatibility-Tracking/dp/B0856W45VL?tag=p00935-20&ascsubtag=05vbUk8CylFgsOTtoYNzfwD>> (Year: 2020).*

“VENZ Pan-Tilt Indoor Security Camera, 360 Degree 2.4G WiFi IP Camera, 1080p HD Pet Camera, Phone App, 2 Way Audio, Motion Detection Night Vision, Cloud & SD Card Storage, Work with Alexa & Google” from Amazon.com, first available Feb. 15, 2022 from the internet <<https://www.amazon.com/dp/B09SH1Y312/>> (Year: 2022).*

* cited by examiner

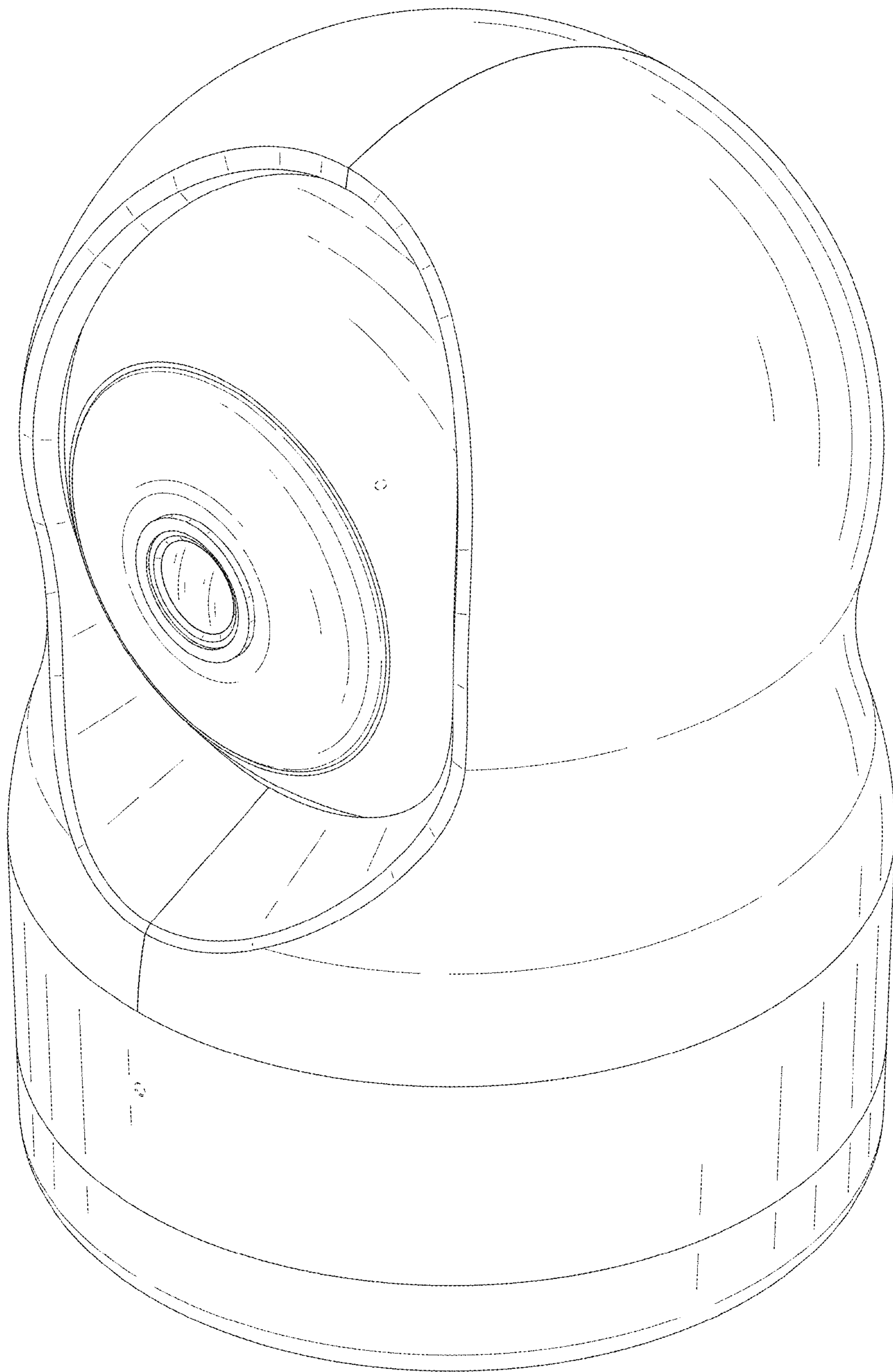

FIG. 1

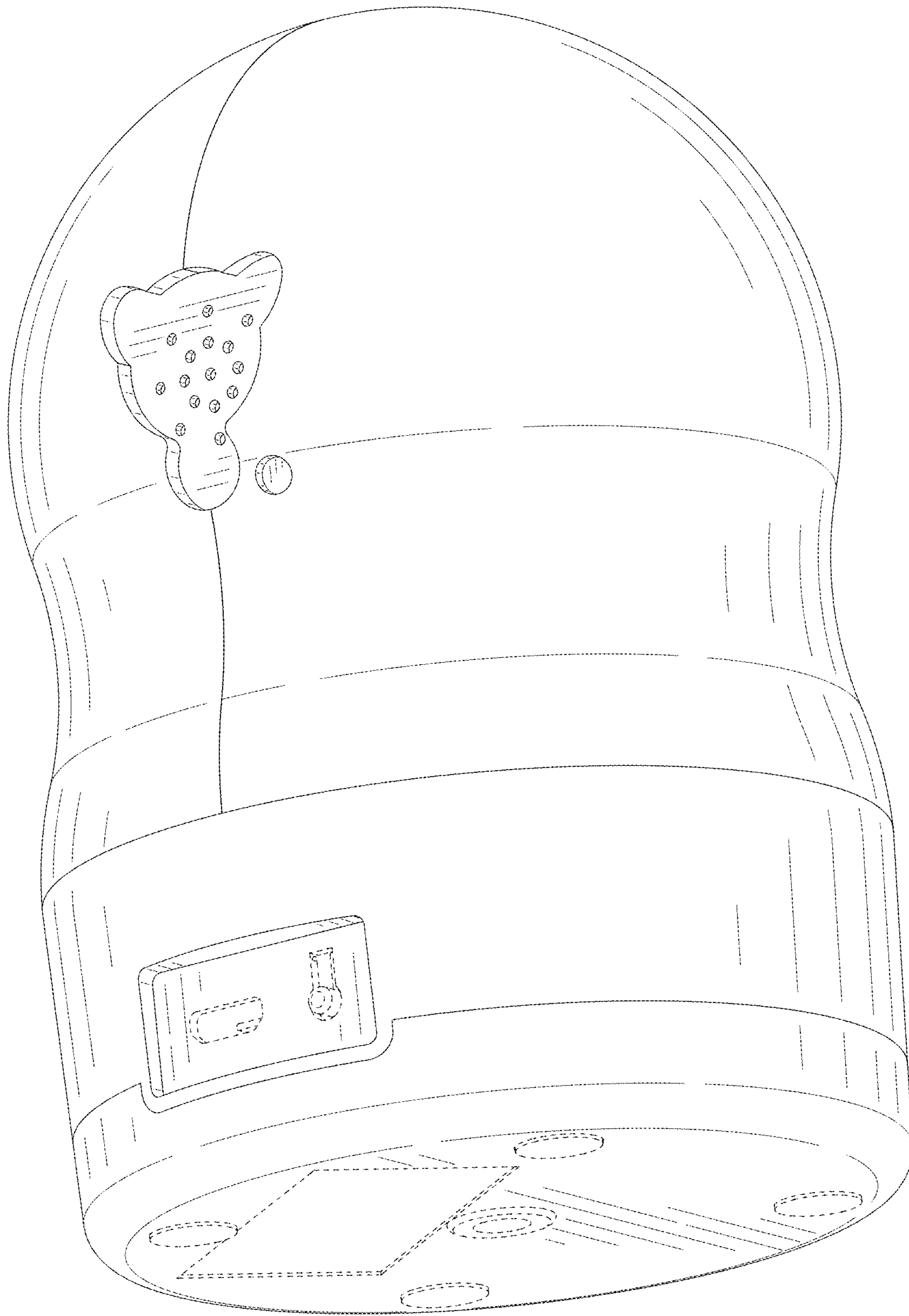

FIG. 2

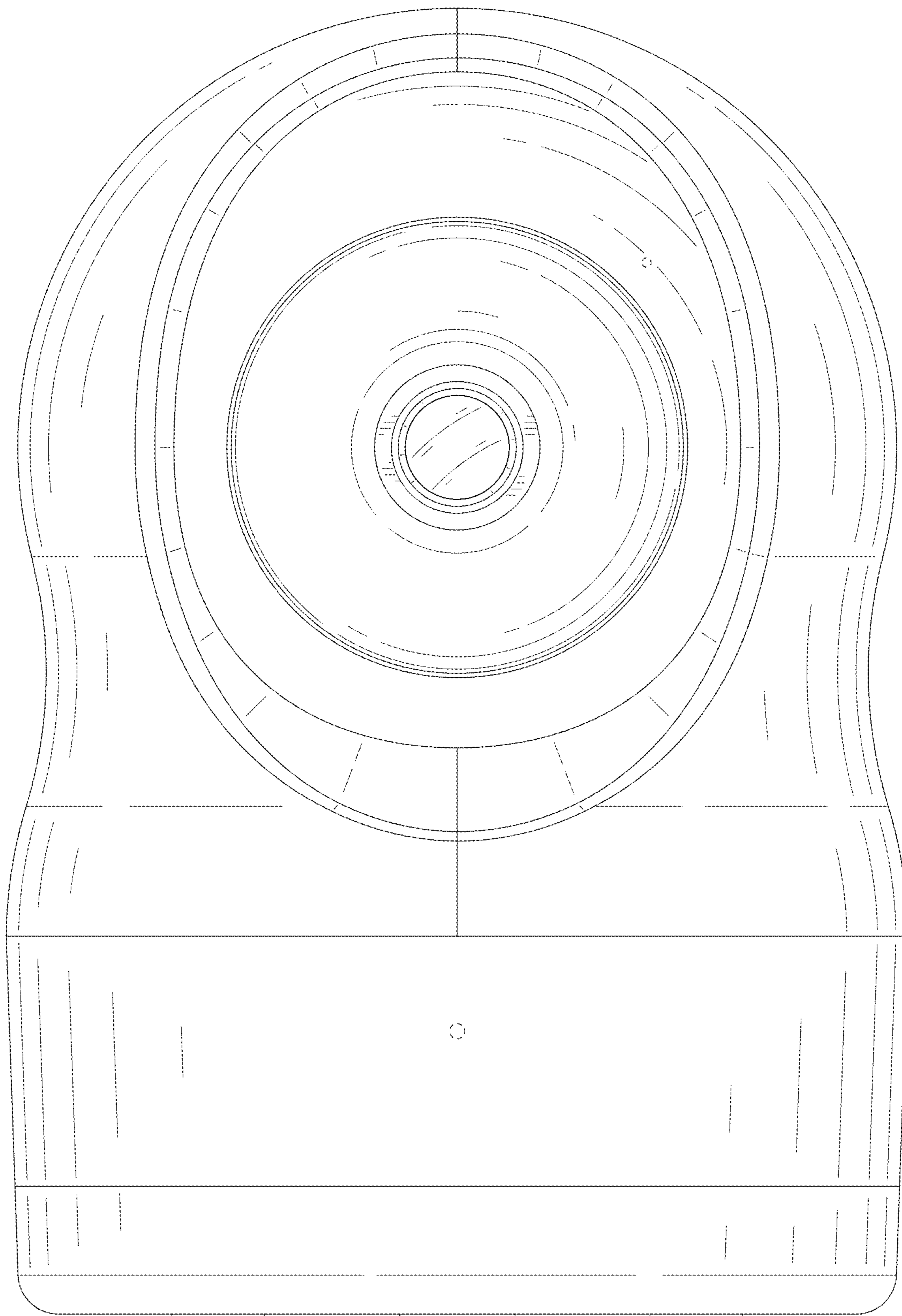

FIG. 3

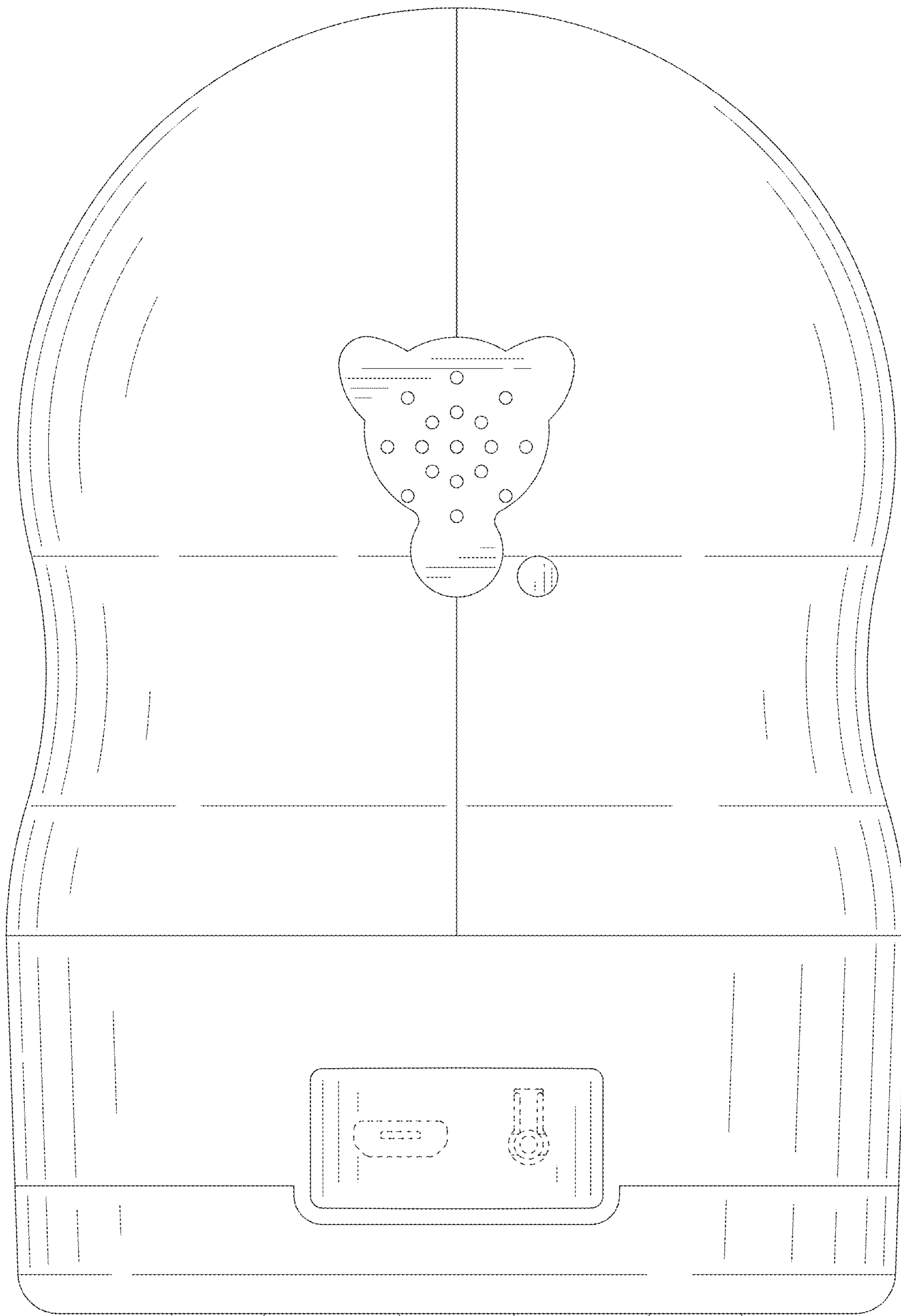

FIG. 4

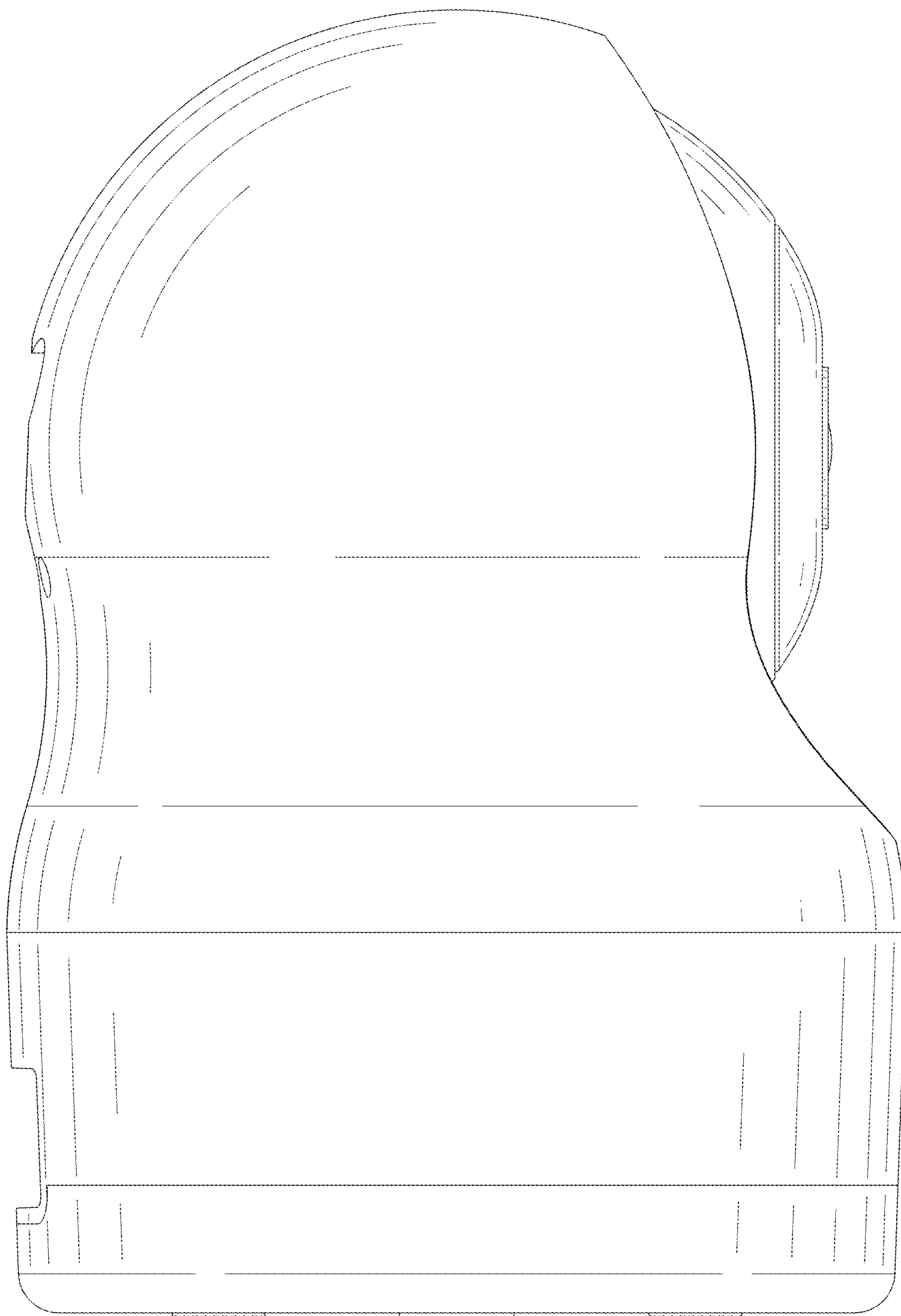

FIG. 5

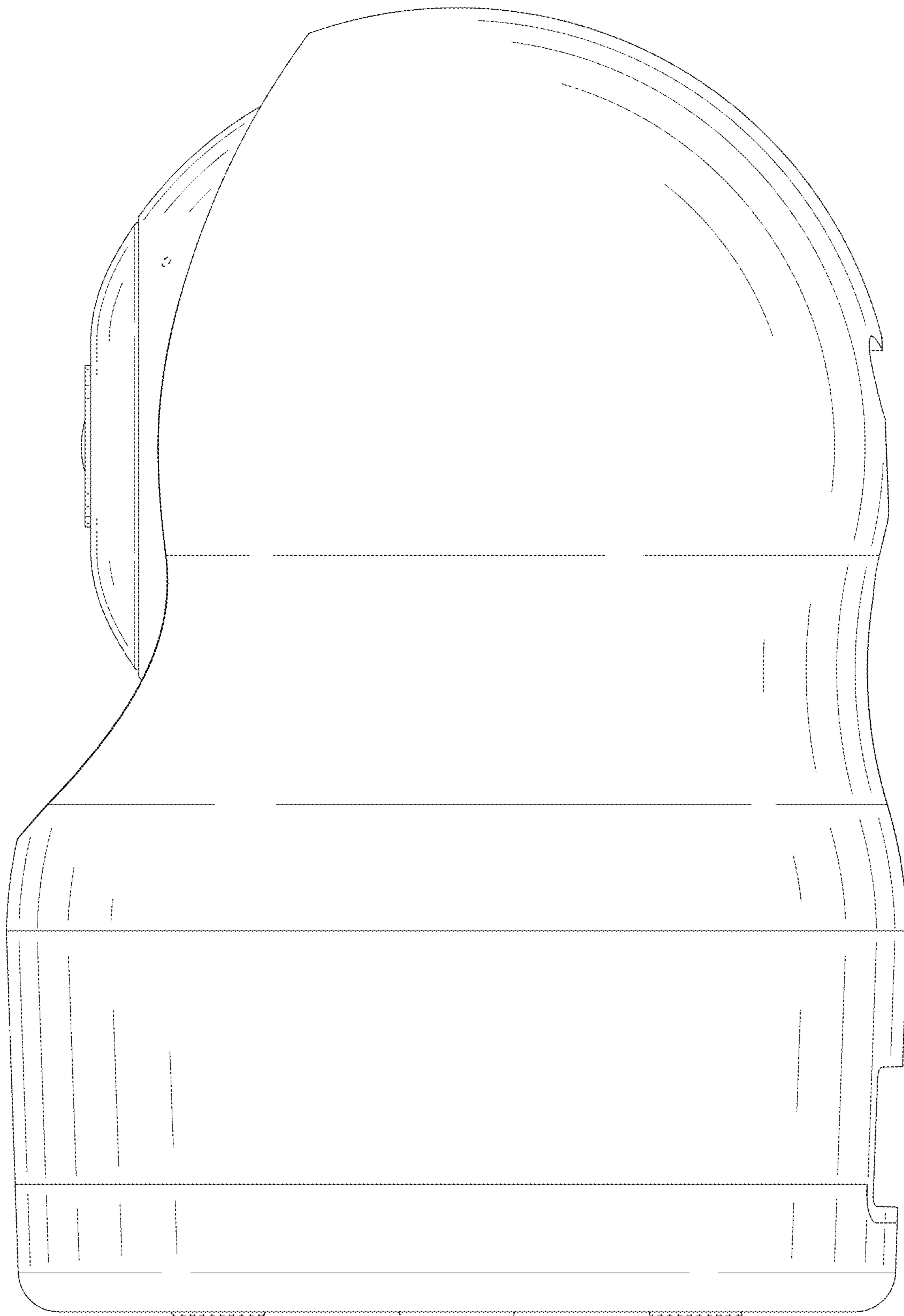

FIG. 6

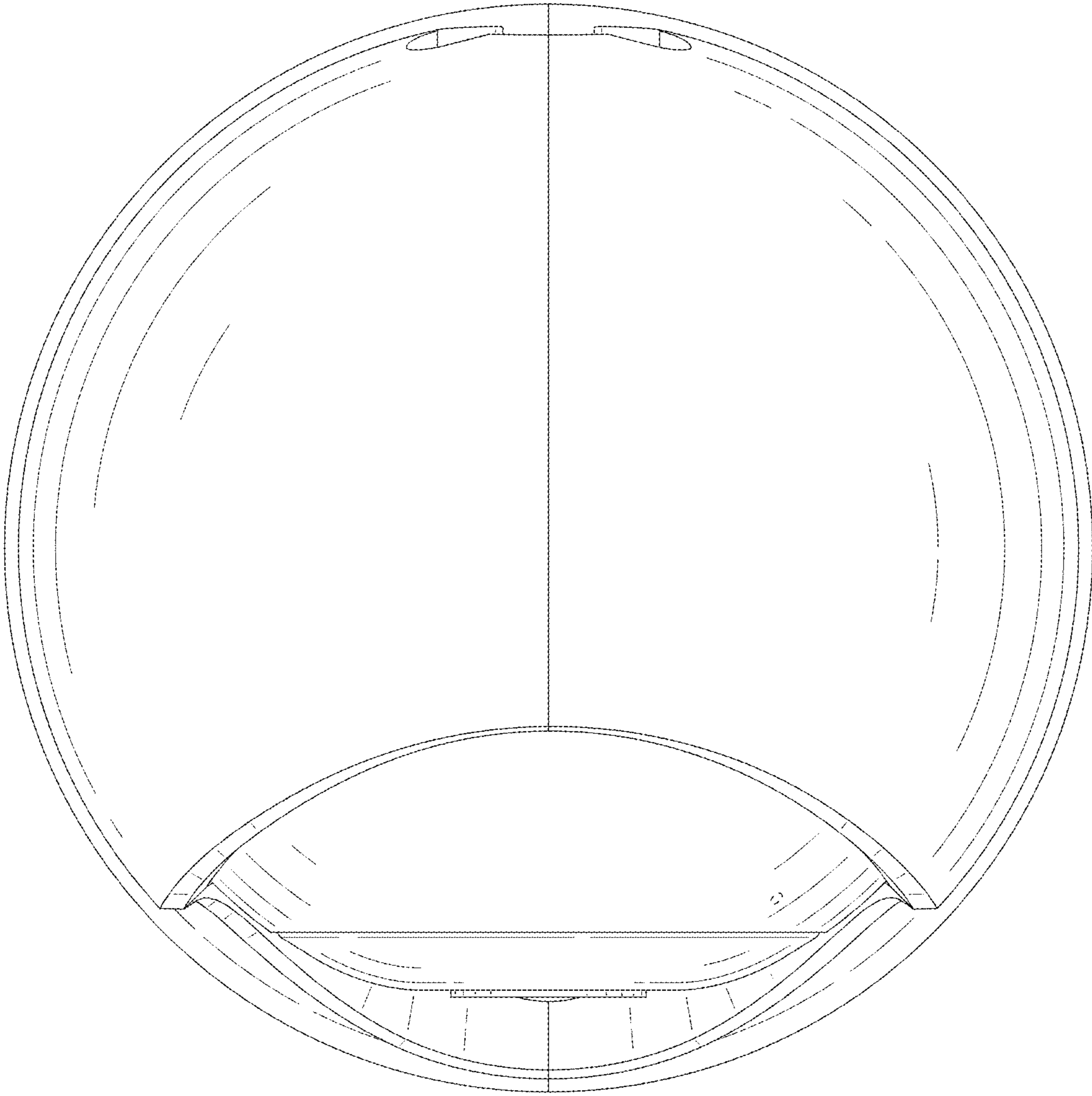

FIG. 7

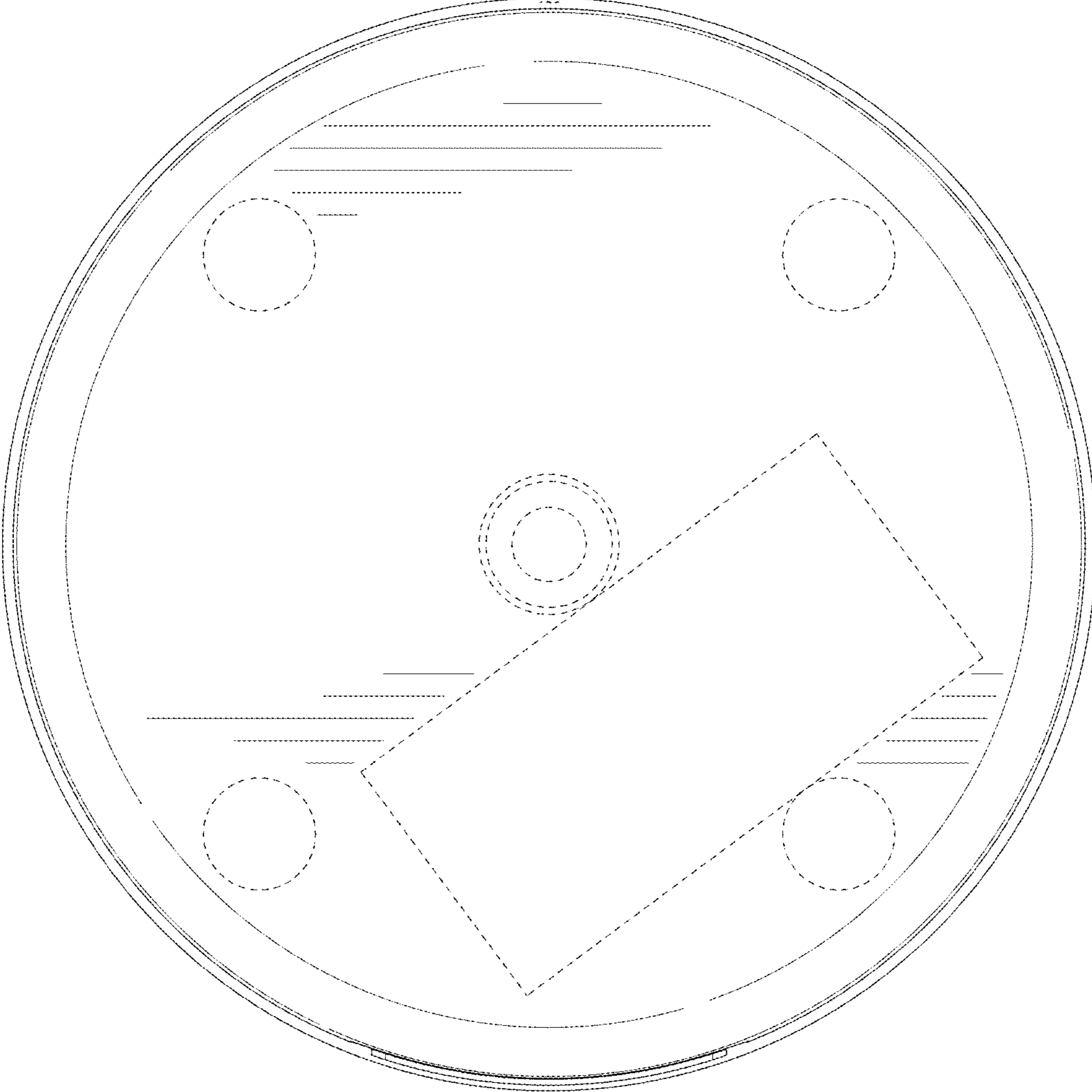

FIG. 8

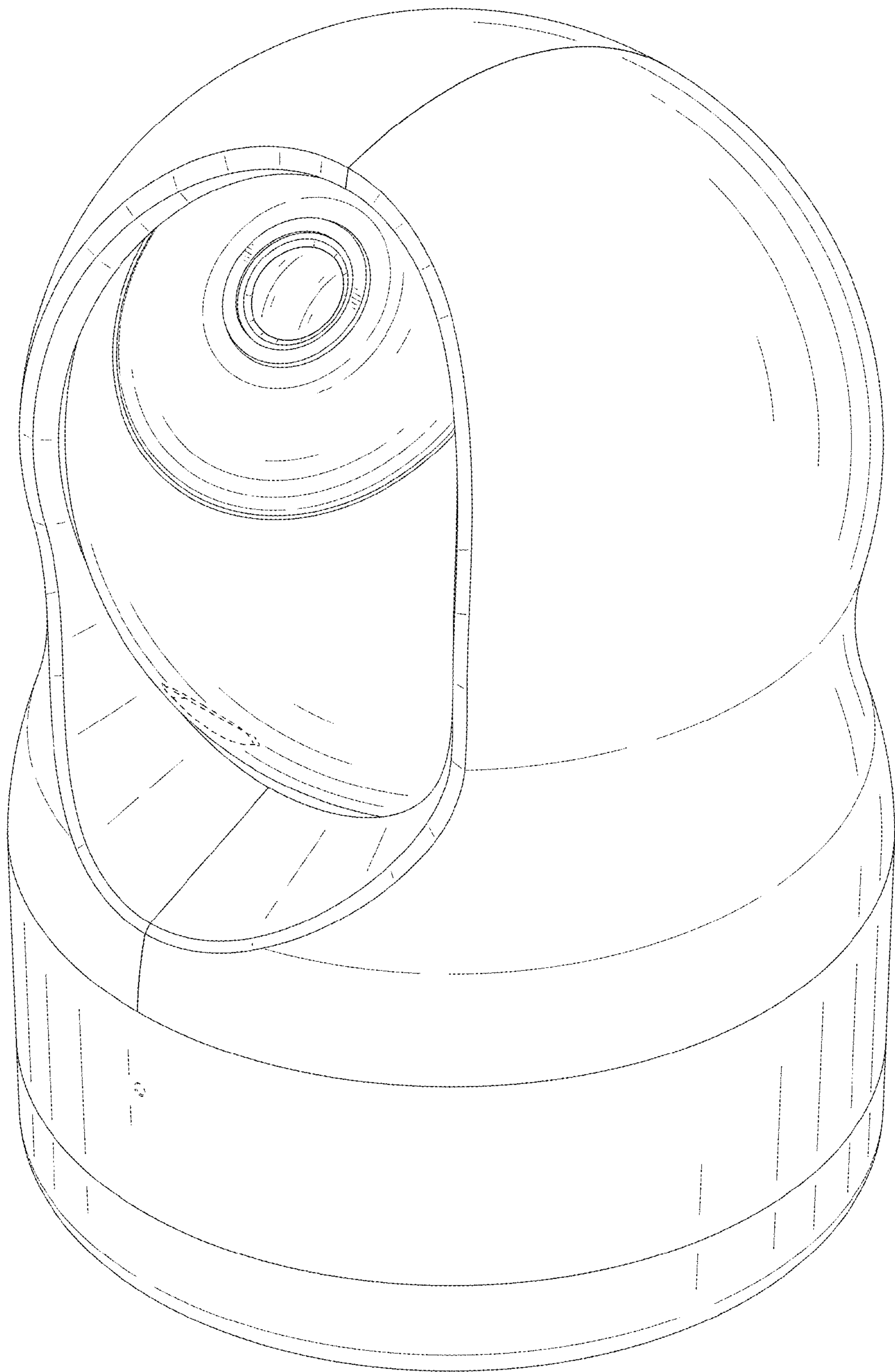

FIG. 9