

US00D967754S

(12) **United States Design Patent**  
**Li**

(10) **Patent No.:** **US D967,754 S**

(45) **Date of Patent:** **\*\* Oct. 25, 2022**

(54) **BATTERY MODULE**

(71) Applicant: **EKEN ELECTRONICS LIMITED,**  
Hongkong (CN)

(72) Inventor: **Fuchang Li,** Hongkong (CN)

(\*\*) Term: **15 Years**

(21) Appl. No.: **29/750,300**

(22) Filed: **Sep. 11, 2020**

(30) **Foreign Application Priority Data**

Aug. 24, 2020 (CN) ..... 202030488644.6

(51) **LOC (13) Cl.** ..... **13-02**

(52) **U.S. Cl.**  
USPC ..... **D13/103**

(58) **Field of Classification Search**

USPC ..... D13/102-106, 110, 118-119, 184  
CPC . Y02E 60/10; H01M 2220/30; H01M 50/209;  
H01M 50/213; H01M 50/183; H01M  
50/10; H01M 50/529; H01M 50/531;  
H01M 10/0525; H01M 10/0436; H01M  
10/052; H01M 10/0565; H01M 10/30;  
H01M 10/345; H01M 10/425; H01M  
2010/0495; B25F 5/02; B25F 5/00; A61B  
2017/00734

See application file for complete search history.

(56) **References Cited**

**U.S. PATENT DOCUMENTS**

D400,496 S \* 11/1998 Barber ..... D13/103  
D405,048 S \* 2/1999 Mason ..... D13/103

D425,479 S \* 5/2000 Melnicoff ..... D13/103  
D426,513 S \* 6/2000 Toops ..... D13/103  
D490,370 S \* 5/2004 Picardo ..... D13/103  
D504,110 S \* 4/2005 Berentzen ..... D13/103  
D557,203 S \* 12/2007 Grunow ..... D13/103  
D594,403 S \* 6/2009 Yang ..... D13/103  
D686,981 S \* 7/2013 Koyabu ..... D13/103  
D830,966 S \* 10/2018 Siminoff ..... D13/103  
D909,291 S \* 2/2021 Lucas ..... D13/103  
D942,372 S \* 2/2022 Kon ..... D13/103  
D942,929 S \* 2/2022 Yi ..... D13/103

\* cited by examiner

*Primary Examiner* — Nathaniel D. Buckner

(57) **CLAIM**

The ornamental design for a battery module, as shown and described.

**DESCRIPTION**

FIG. 1 is a perspective view of a battery module showing my new design;  
FIG. 2 is another perspective view thereof;  
FIG. 3 is a front view thereof;  
FIG. 4 is a rear view thereof;  
FIG. 5 is a left side view thereof;  
FIG. 6 is a right side view thereof;  
FIG. 7 is a top plan view thereof; and,  
FIG. 8 is a bottom plan view thereof.  
The broken lines in the figures illustrate portions of the battery module that form no part of the claimed design.

**1 Claim, 7 Drawing Sheets**

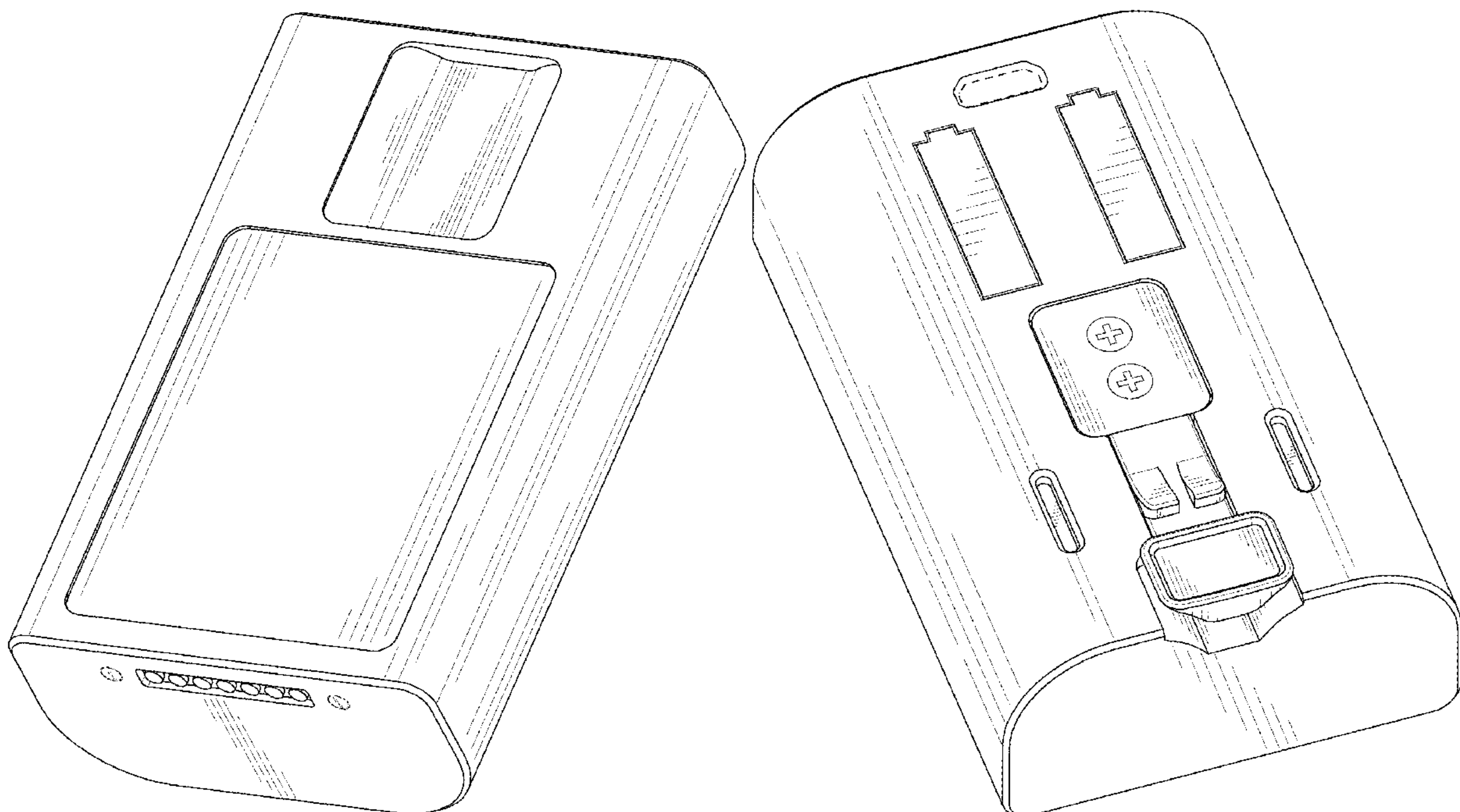

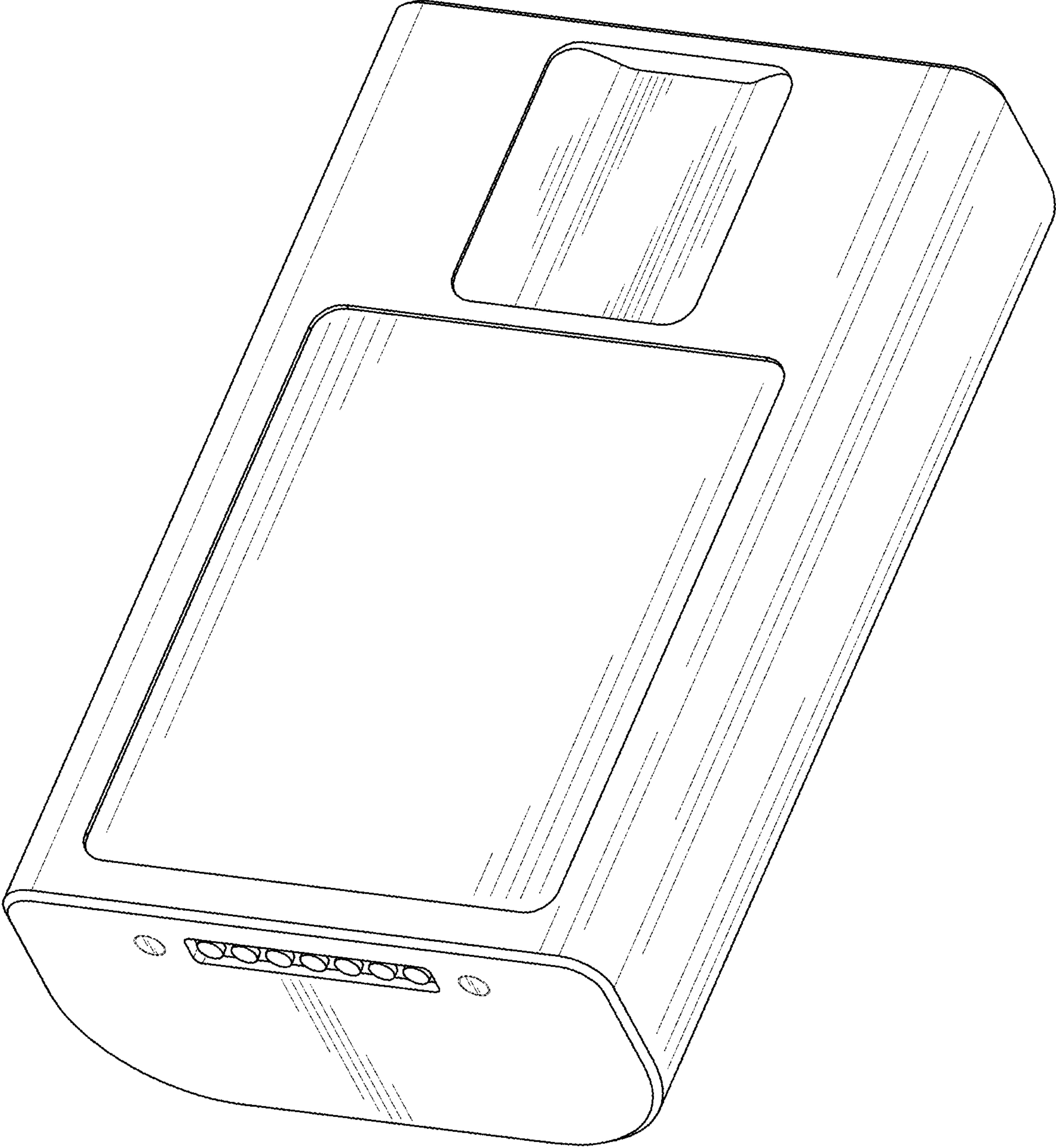

FIG. 1

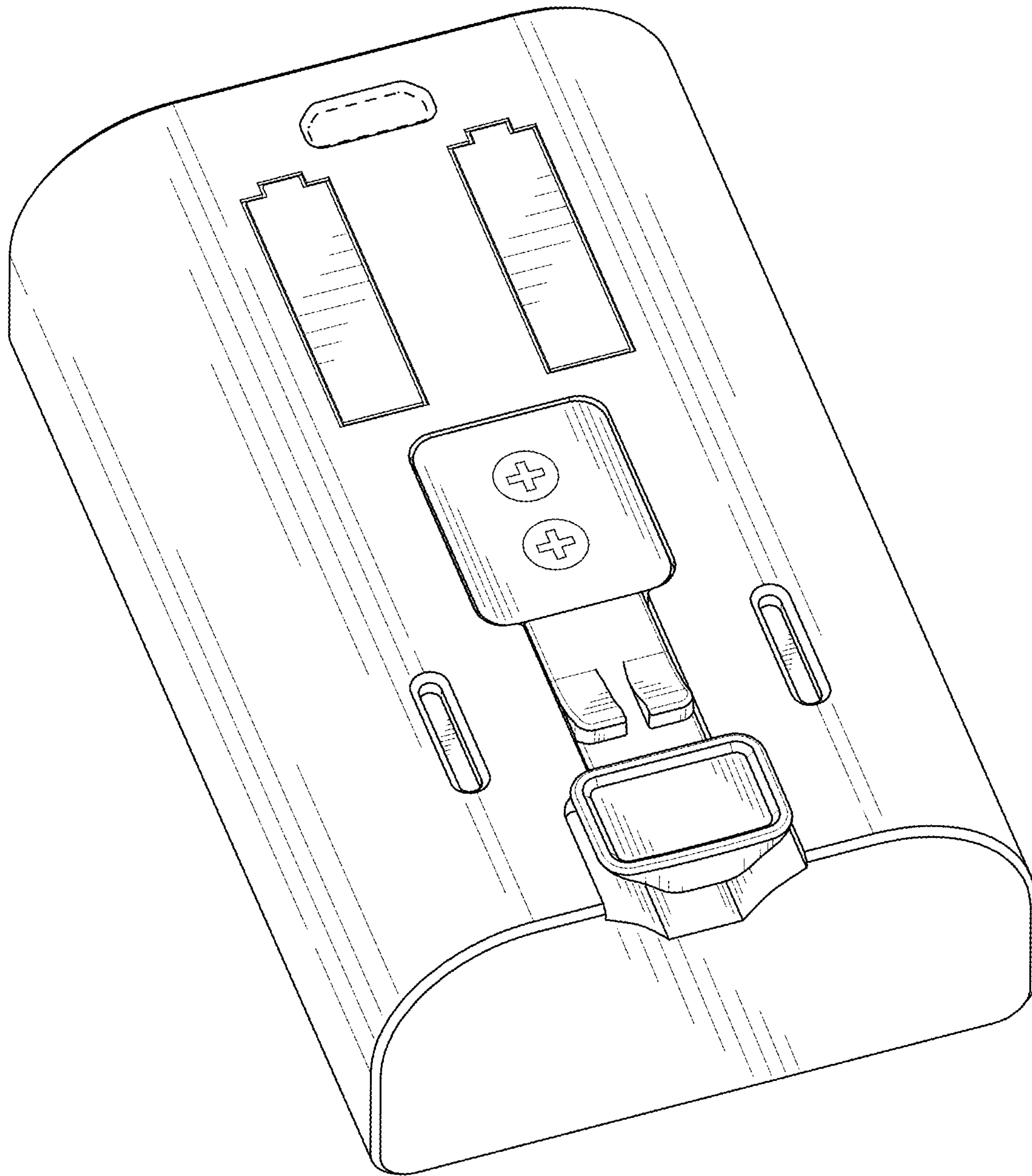

FIG. 2



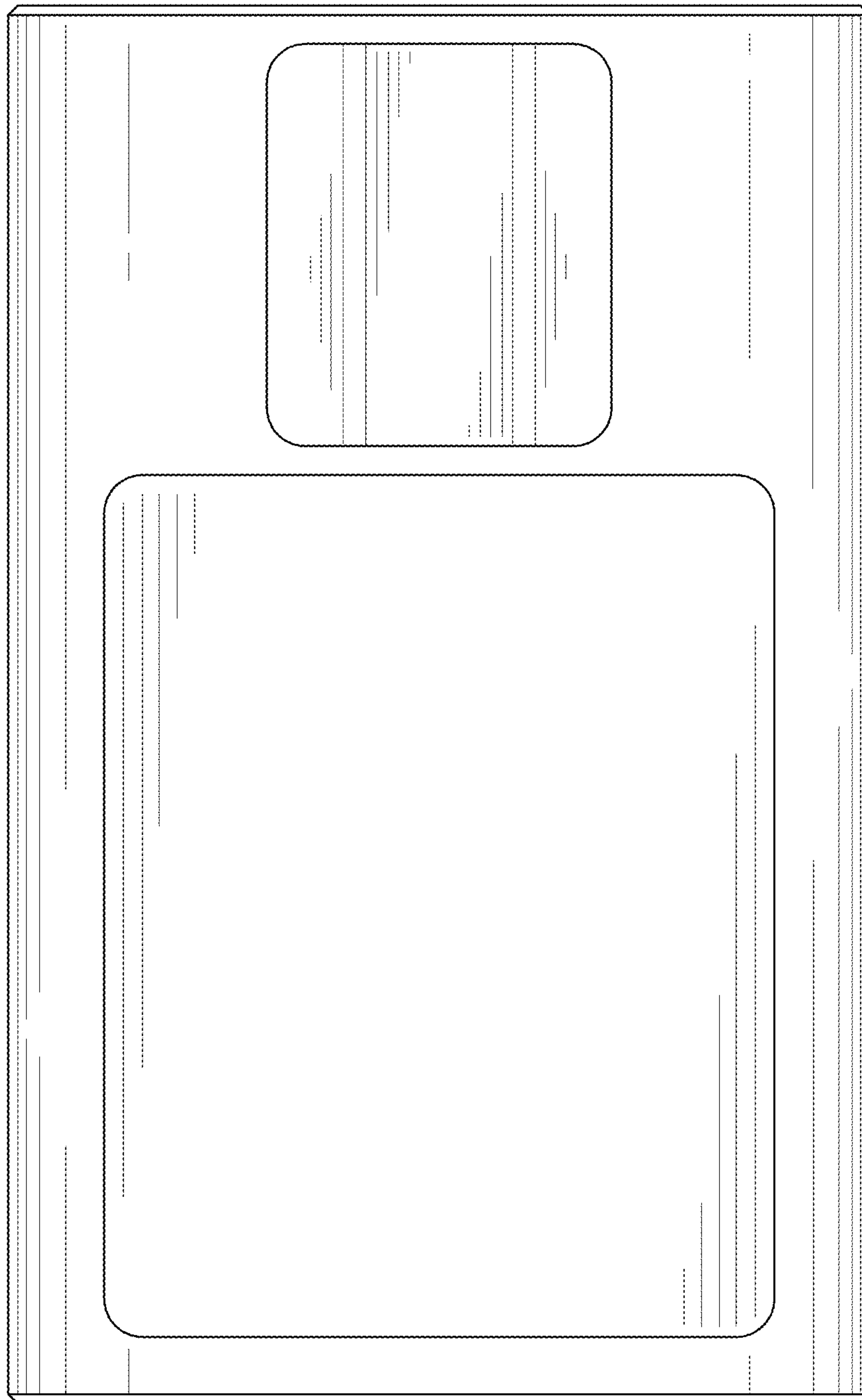

FIG. 3

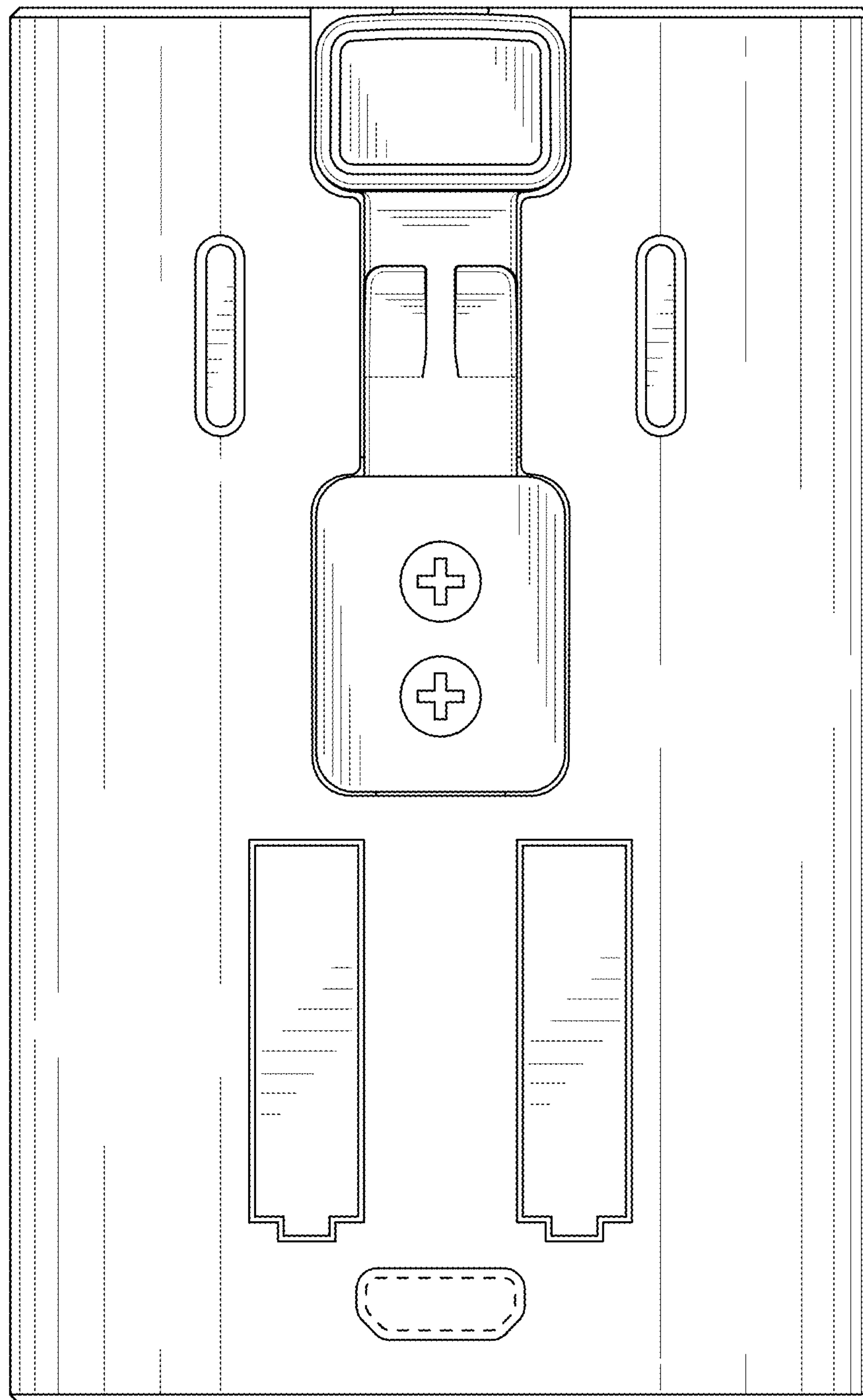

FIG. 4

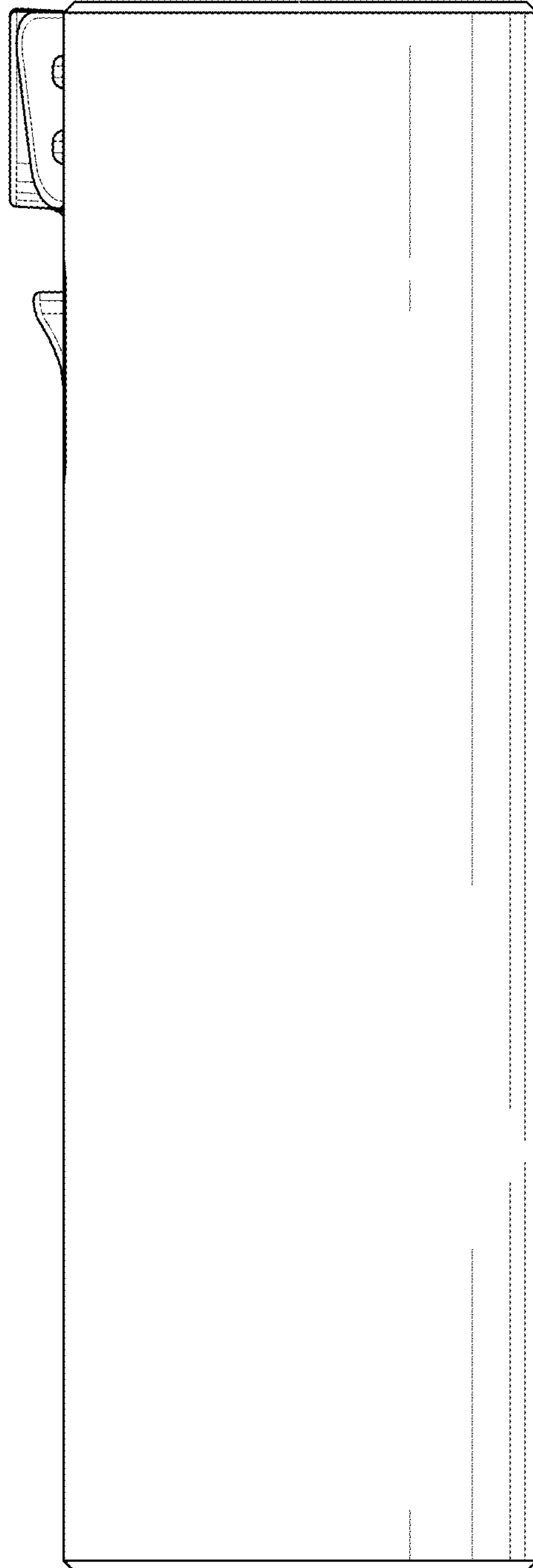

FIG. 5

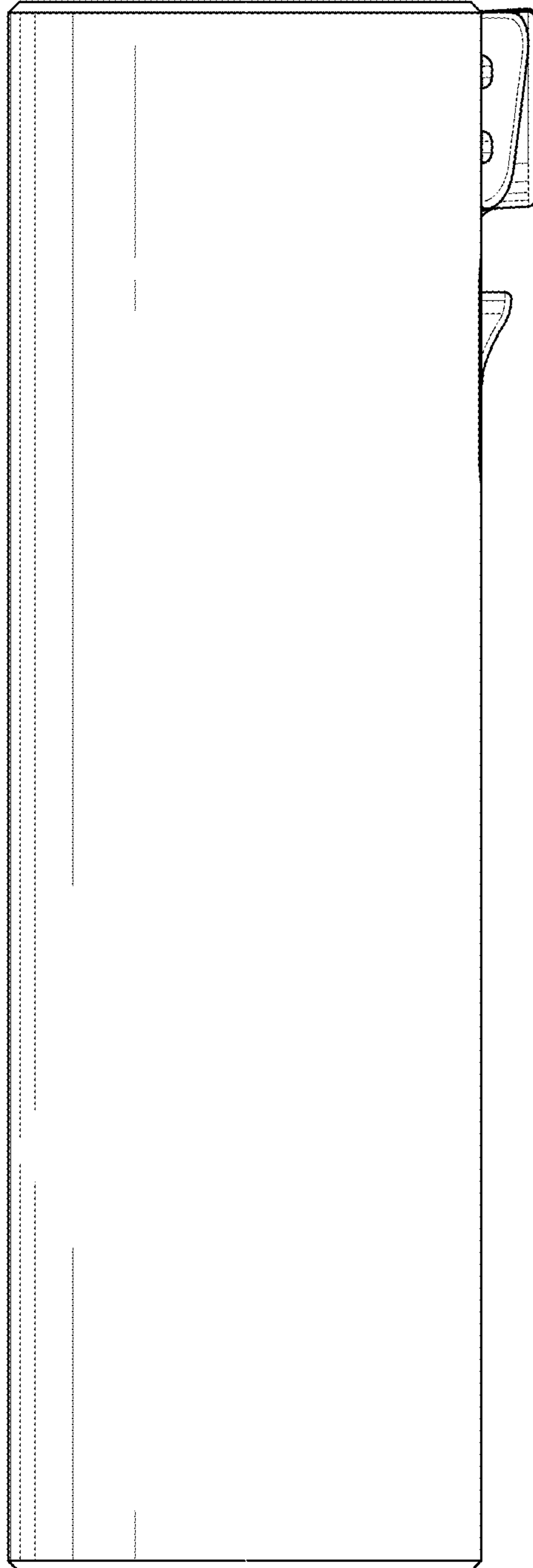

FIG. 6

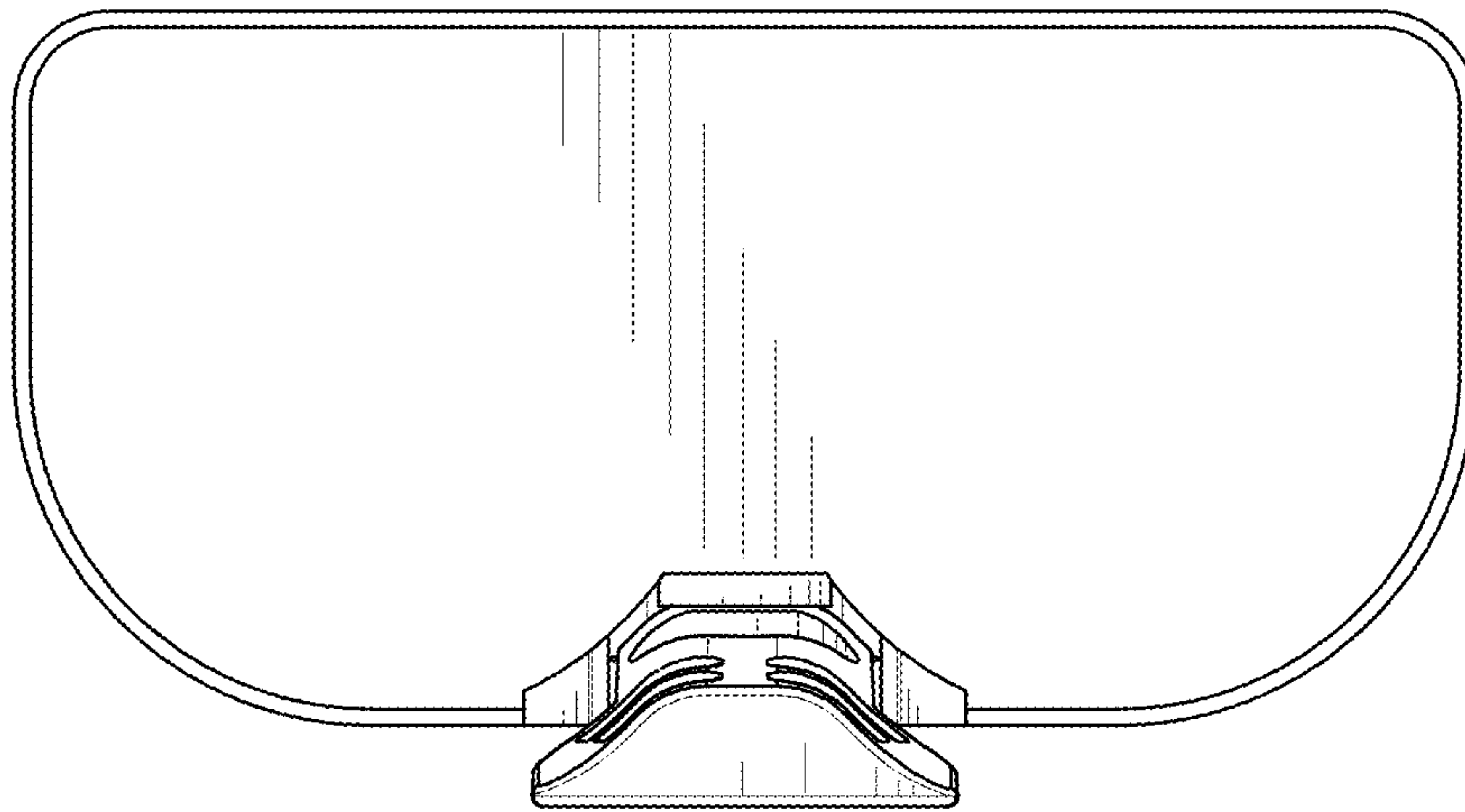

FIG. 7

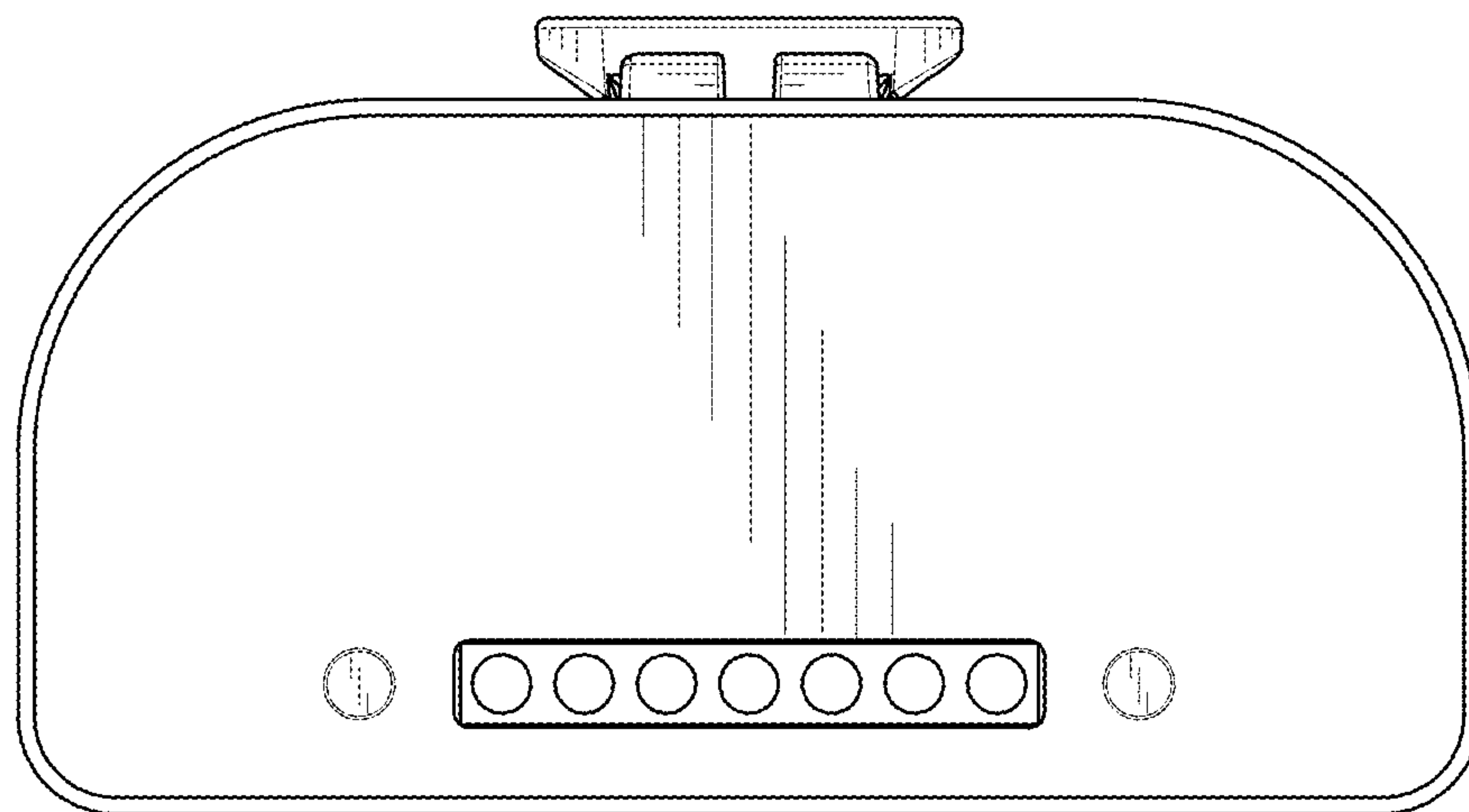

FIG. 8