

US00D967723S

(12) **United States Design Patent** (10) **Patent No.:** **US D967,723 S**  
**Kornegay et al.** (45) **Date of Patent:** **\*\* Oct. 25, 2022**

(54) **SENSOR**

(71) Applicant: **Comcast Cable Communications, LLC**, Philadelphia, PA (US)

(72) Inventors: **Devlyn Kornegay**, Richmond, VA (US); **Michael Jou**, Philadelphia, PA (US); **Zhe Zhang**, Wood Ridge, NJ (US); **Henry Homza**, Philadelphia, PA (US); **Nicholas Stefano**, Haddon Heights, NJ (US)

(73) Assignee: **Comcast Cable Communications, LLC**, Philadelphia, PA (US)

(\*\*) Term: **15 Years**

(21) Appl. No.: **29/751,545**

(22) Filed: **Sep. 22, 2020**

(51) **LOC (13) Cl.** ..... **10-05**

(52) **U.S. Cl.**  
 USPC ..... **D10/106.6; D10/106.1**

(58) **Field of Classification Search**  
 USPC ..... D10/104.1-106.95, 118-118.2, 70, 46, D10/81, 96-103; D14/240, 242, 300, D14/383-385; D8/330-332  
 CPC ..... G08B 25/10; G08B 29/22; G08B 29/046; G08B 6/00; G08B 5/36; G08B 13/2491; G08B 13/24; G08B 3/10; G08B 13/08; G08B 25/008; G08B 13/1472; G08B 13/149; G01R 33/02; G01R 33/038; G01R 33/0047; G01R 33/0023; G01R 33/0088; G01V 3/081; G10K 15/04; G10K 1/067; H04N 5/2252; H04N 7/186; H04N 5/2256; H05K 1/144; G06K 7/10425; G06K 19/0723; G06K 7/10297; G06K 7/10366; H04W 4/80; G07C 9/29; G07C 9/28; G07C 9/00182; G07C 2209/61; G07C 2209/63; G01S 13/765; G06F 21/70; G06F 21/86; G06F 1/24; H01Q 5/25

See application file for complete search history.

(56) **References Cited**

U.S. PATENT DOCUMENTS

D666,934	S	*	9/2012	Krumpe	.....	D10/106.6
D805,941	S	*	12/2017	Jou	.....	D10/118.2
D833,311	S	*	11/2018	Reimer	.....	D10/106.6
D848,294	S	*	5/2019	Laurans	.....	D10/70
D893,330	S	*	8/2020	Xu	.....	D10/106.1
D926,063	S	*	7/2021	Garipov	.....	D10/106.1
D940,581	S	*	1/2022	Wang	.....	D10/106.6
D941,693	S	*	1/2022	Walliser	.....	D10/52
D949,135	S	*	4/2022	Homza	.....	D14/242
D951,781	S	*	5/2022	Ribeiro	.....	D10/53
2017/0055890	A1	*	3/2017	Kube	.....	H02J 50/05
2021/0209907	A1	*	7/2021	Carlson	.....	G06K 7/10425
2022/0101705	A1	*	3/2022	Carlson	.....	G08B 3/10

FOREIGN PATENT DOCUMENTS

CN	305159637	*	12/2018
CN	305780335	*	11/2019
CN	306876105	*	4/2021
CN	C307346994	*	3/2022
GB	8102175000-2000	*	6/2018
JP	D1677183	*	4/2020
WO	D211711-002	*	10/2020

OTHER PUBLICATIONS

Zigbee, Door Window Sensors, Date first available Feb. 7, 2017, [online]retrieved Jun. 7, 2022, available from <https://www.amazon.com/Zigbee-Sensors-XHS2-TY-XHS2-UE-Security/dp/B01N3CVD4L> (Year: 2017).\*

2gig, DW10 Thin Door Window Contact ETL, Date first available Jun. 26, 2010, [online]retrieved Jun. 14, 2022, available from [https://www.amazon.com/2gig-DW10-Window-Contact-Listed/dp/B003TZ9YZU/ref=sr\\_1\\_72\\_sspa?crd=OGBQW34CNX0V&keywords=XFINITY+Door%2FWindow+sensor&qid=1655301309&s=hi&sprefix=xfinity+door%2](https://www.amazon.com/2gig-DW10-Window-Contact-Listed/dp/B003TZ9YZU/ref=sr_1_72_sspa?crd=OGBQW34CNX0V&keywords=XFINITY+Door%2FWindow+sensor&qid=1655301309&s=hi&sprefix=xfinity+door%2) (Year: 2010).\*

Ecolink, Z-wave Plus Rare Earth Magnets Door & Window Sensor, Date first available Oct. 1, 2016, [online]retrieved Jun. 15, 2022, available from [https://www.amazon.com/Z-Wave-Magnets-Window-Sensor-DWZWAVE2-5-ECO/dp/B01N5HB4U5/ref=sr\\_1\\_5?crd=OGBQW34CNX0V&keywords=XFINITY+Door%2FWindow+sensor&qid=1655301220](https://www.amazon.com/Z-Wave-Magnets-Window-Sensor-DWZWAVE2-5-ECO/dp/B01N5HB4U5/ref=sr_1_5?crd=OGBQW34CNX0V&keywords=XFINITY+Door%2FWindow+sensor&qid=1655301220) (Year: 2016).\*

VOCOLINC Sensor, Door Window Alarm Magnetic Contact Sensor, Date first available Apr. 26, 2020, [online]retrieved Jun. 15, 2022, available from [https://www.amazon.com/dp/B087PCQ518/ref=sspa\\_dk\\_detail\\_6?psc=1&pd\\_rd\\_i=B087PCQ518&pd\\_rd\\_w=ncOq2](https://www.amazon.com/dp/B087PCQ518/ref=sspa_dk_detail_6?psc=1&pd_rd_i=B087PCQ518&pd_rd_w=ncOq2)

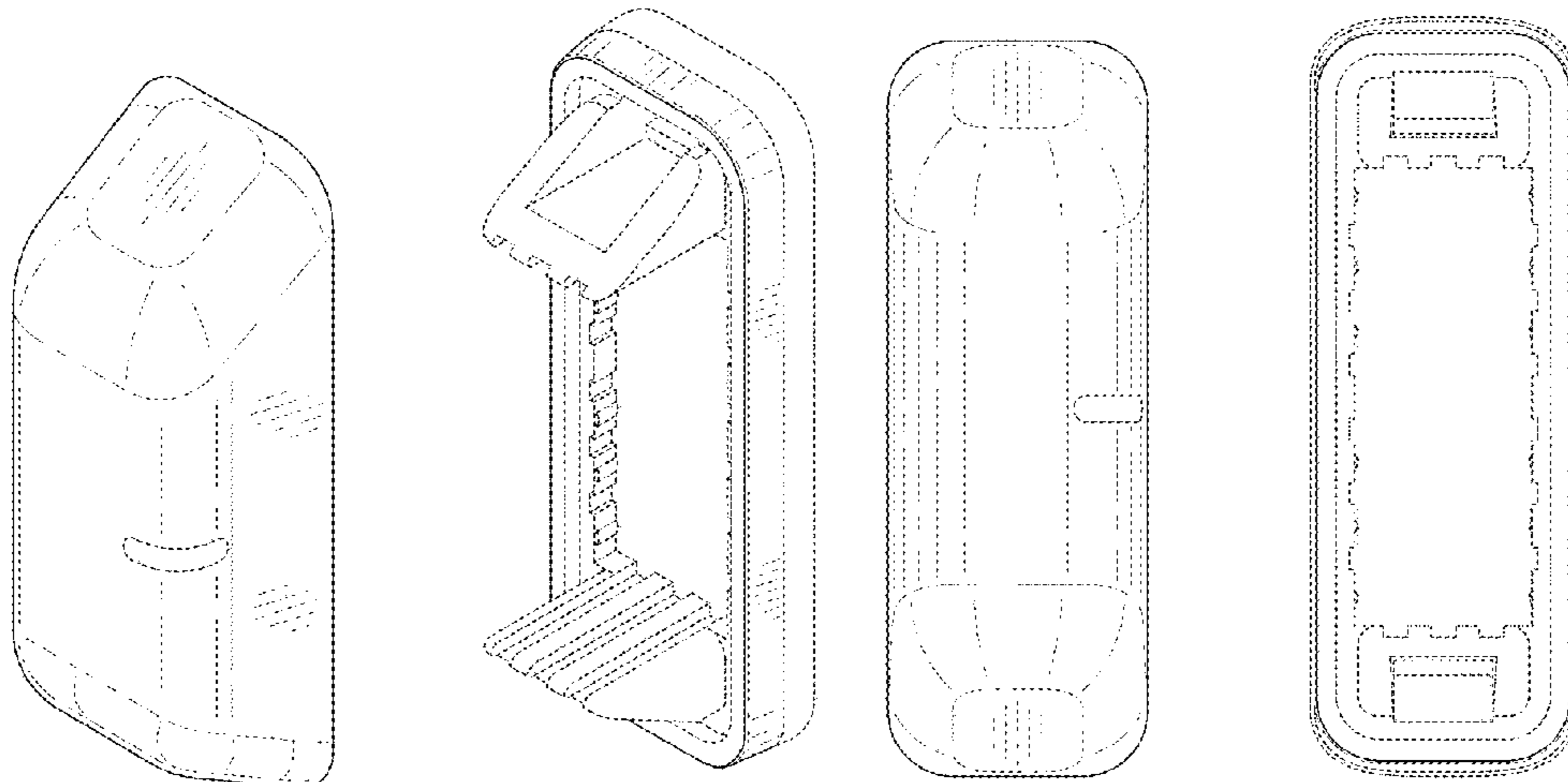

&content-id=amzn1.sym.3481f441-61ac-4028-9c1a-7f9ce8ec50c5  
&pf\_rd\_p= (Year: 2020).\*

\* cited by examiner

*Primary Examiner* — Keli L Hill

*Assistant Examiner* — Sara S Sahneh

(74) *Attorney, Agent, or Firm* — Banner & Witcoff, Ltd.

(57) **CLAIM**

The ornamental design for a sensor, as shown and described.

**DESCRIPTION**

FIG. 1 is a front perspective view of a sensor showing our new design in an unassembled state;  
FIG. 2 is a front view thereof;  
FIG. 3 is a rear view thereof;  
FIG. 4 is a left side view thereof;  
FIG. 5 is a right side view thereof;  
FIG. 6 is a top view thereof;  
FIG. 7 is a bottom view thereof;  
FIG. 8 is a front perspective view of the sensor of FIGS. 1-7 shown in an assembled state;  
FIG. 9 is a front view thereof;  
FIG. 10 is a rear view thereof;  
FIG. 11 is a left side view thereof;

FIG. 12 is a right side view thereof;  
FIG. 13 is a top view thereof;  
FIG. 14 is a bottom view thereof;  
FIG. 15 is a front perspective view of the front portion of the sensor of FIGS. 1-7 shown in isolation;  
FIG. 16 is a front view thereof;  
FIG. 17 is a rear view thereof;  
FIG. 18 is a left side view thereof;  
FIG. 19 is a right side view thereof;  
FIG. 20 is a top view thereof;  
FIG. 21 is a bottom view thereof;  
FIG. 22 is a front perspective view of the rear portion of the sensor of FIGS. 1-7 shown in isolation;  
FIG. 23 is a front view thereof;  
FIG. 24 is a rear view thereof;  
FIG. 25 is a left side view thereof;  
FIG. 26 is a right side view thereof;  
FIG. 27 is a top view thereof; and,  
FIG. 28 is a bottom view thereof.  
The broken line oval within the shaded area on the front face of the sensor forms no part of the claimed design. The broken lines immediately adjacent to the shaded areas represent the bounds of the claimed design and form no part thereof. The broken lines depicting the remainder of the sensor form no part of the claimed design.

**1 Claim, 28 Drawing Sheets**

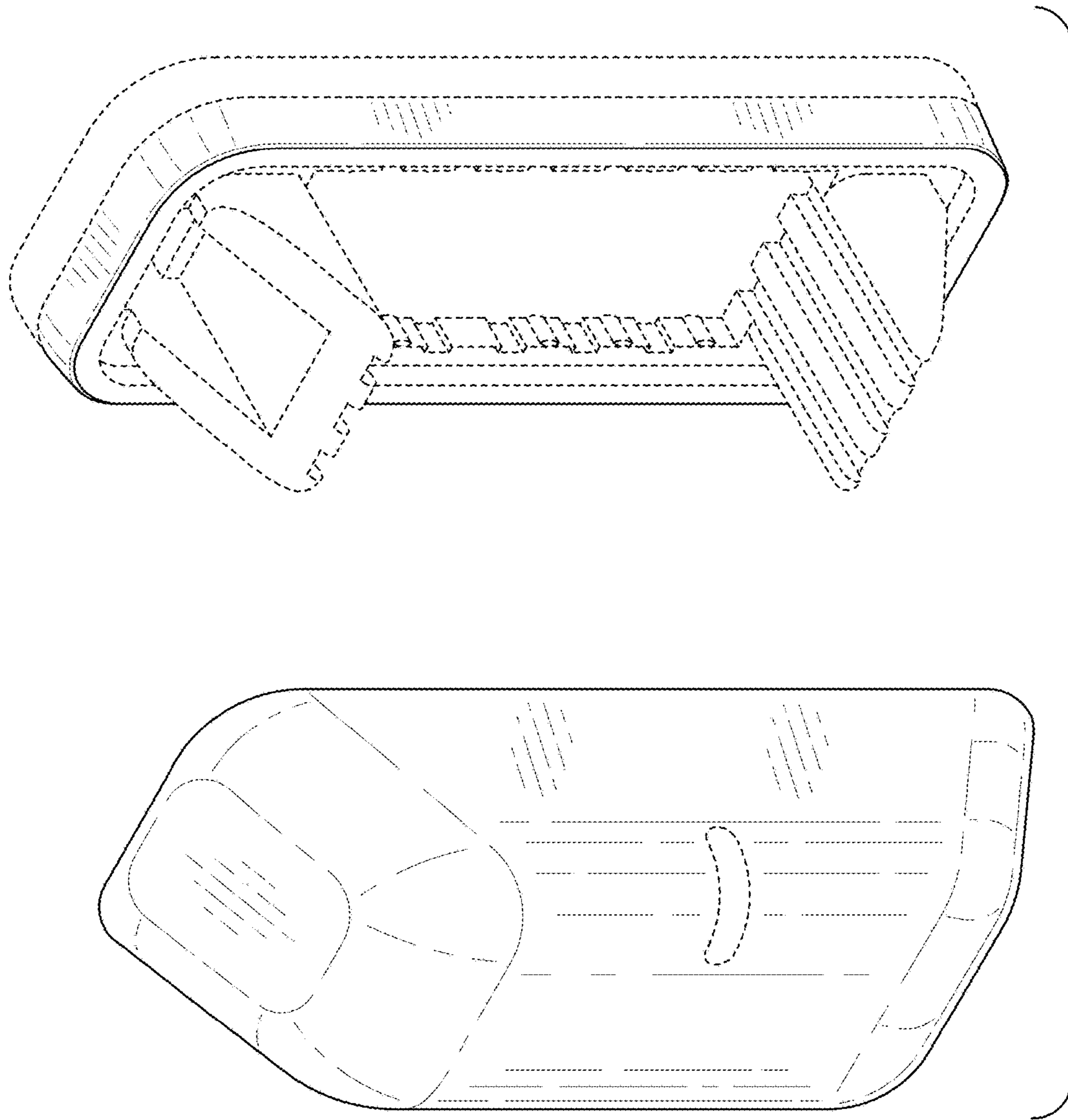

FIG. 1



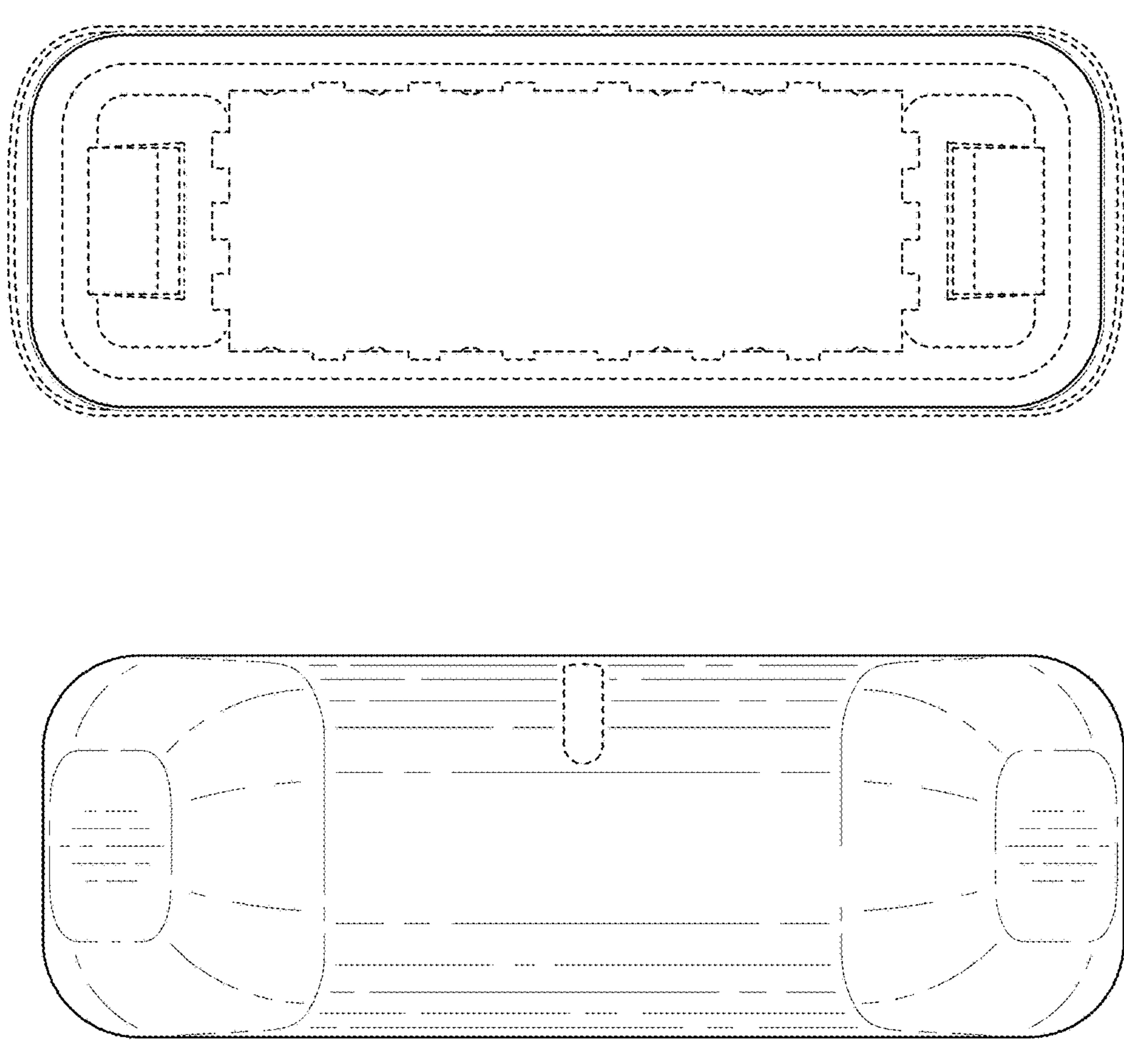

FIG. 2

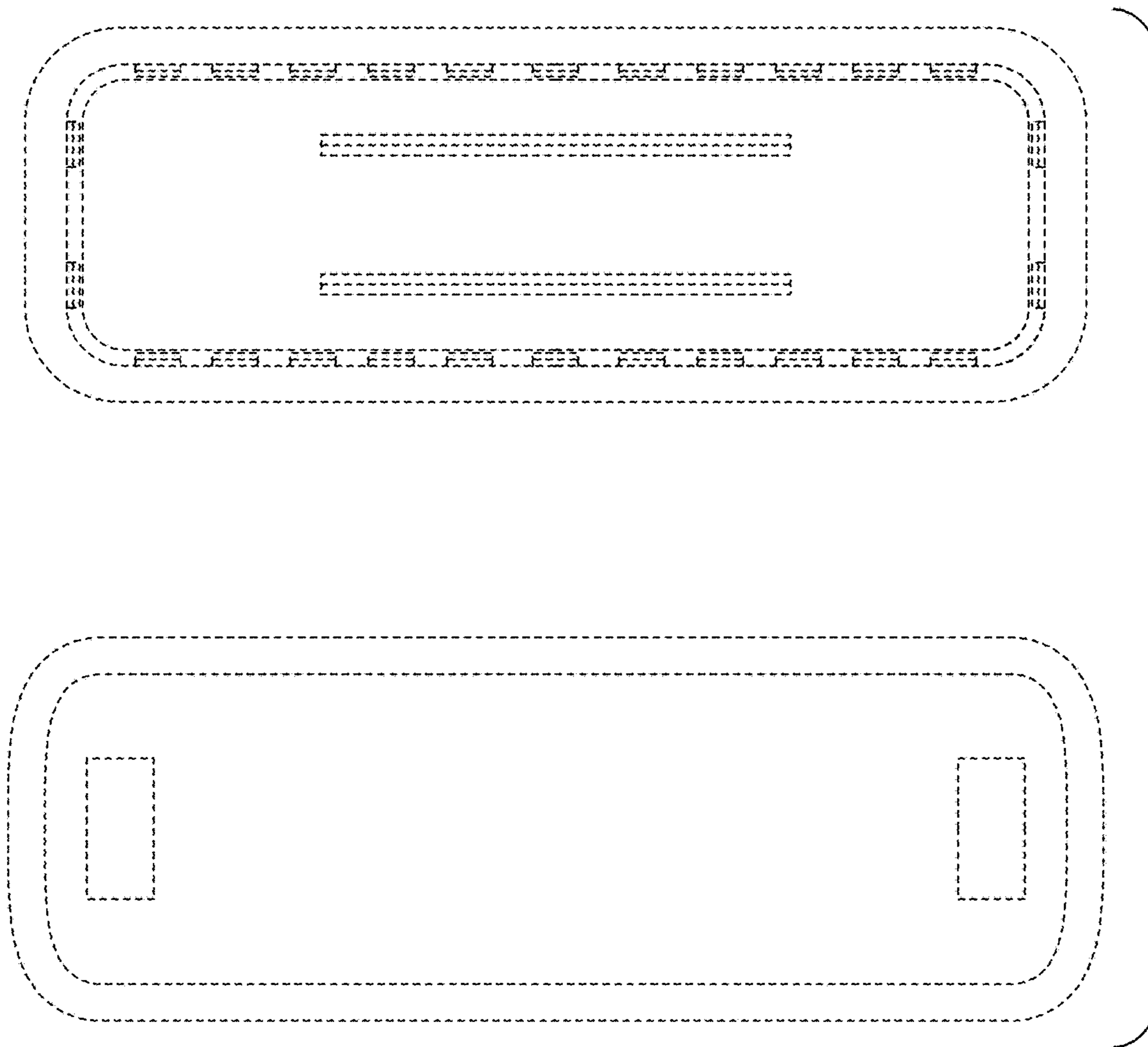

FIG. 3

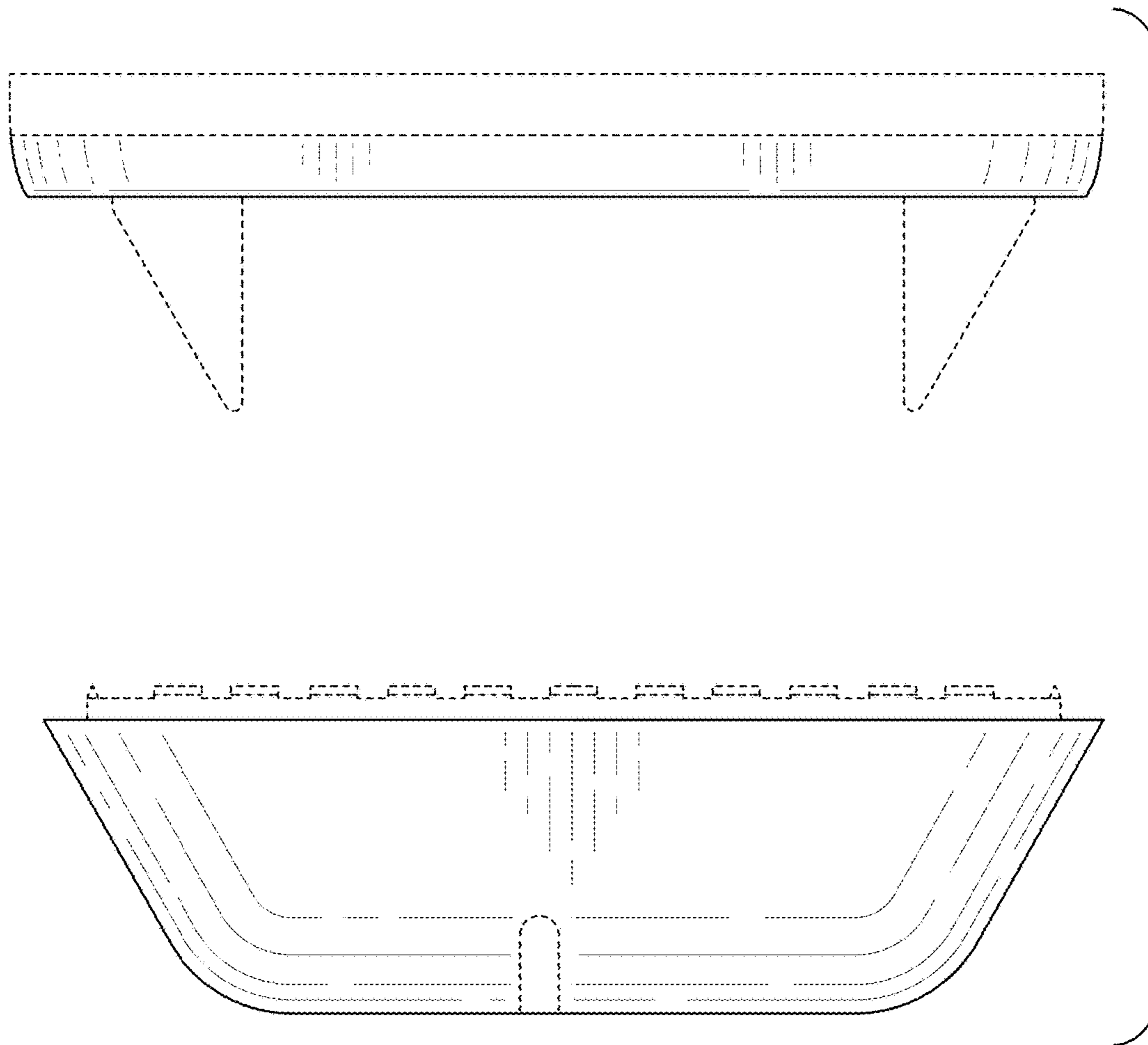

FIG. 4

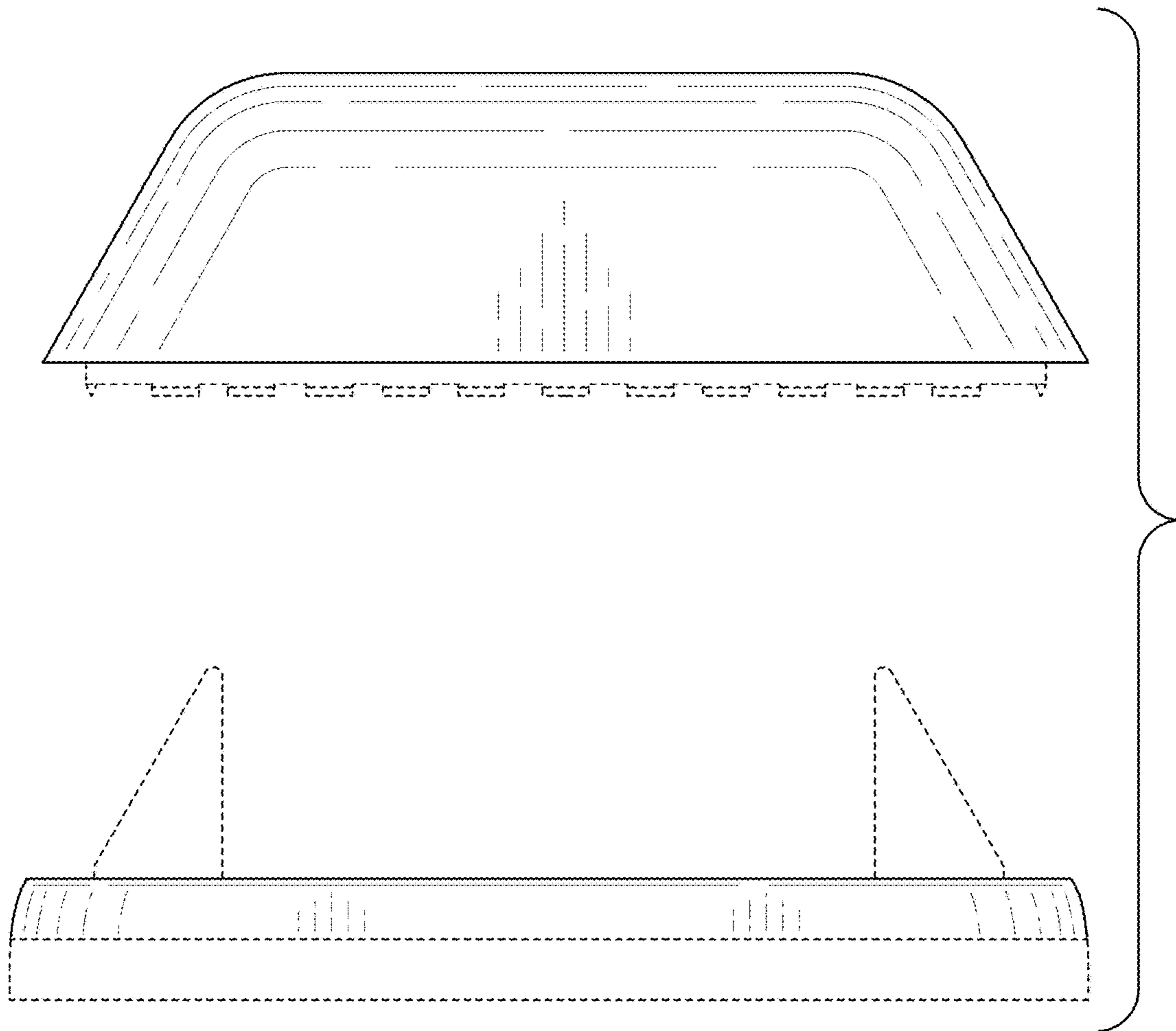

FIG. 5

FIG. 6

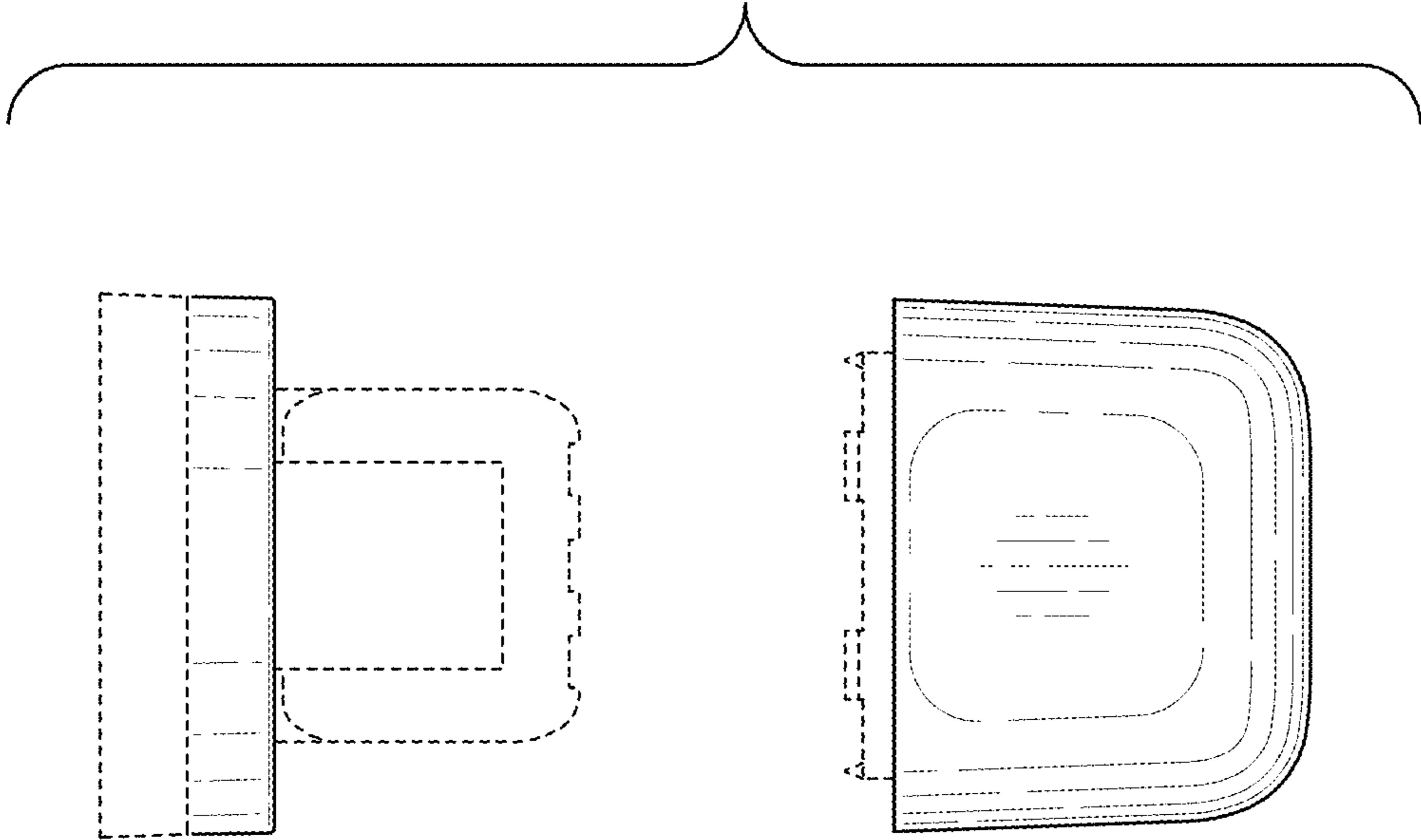
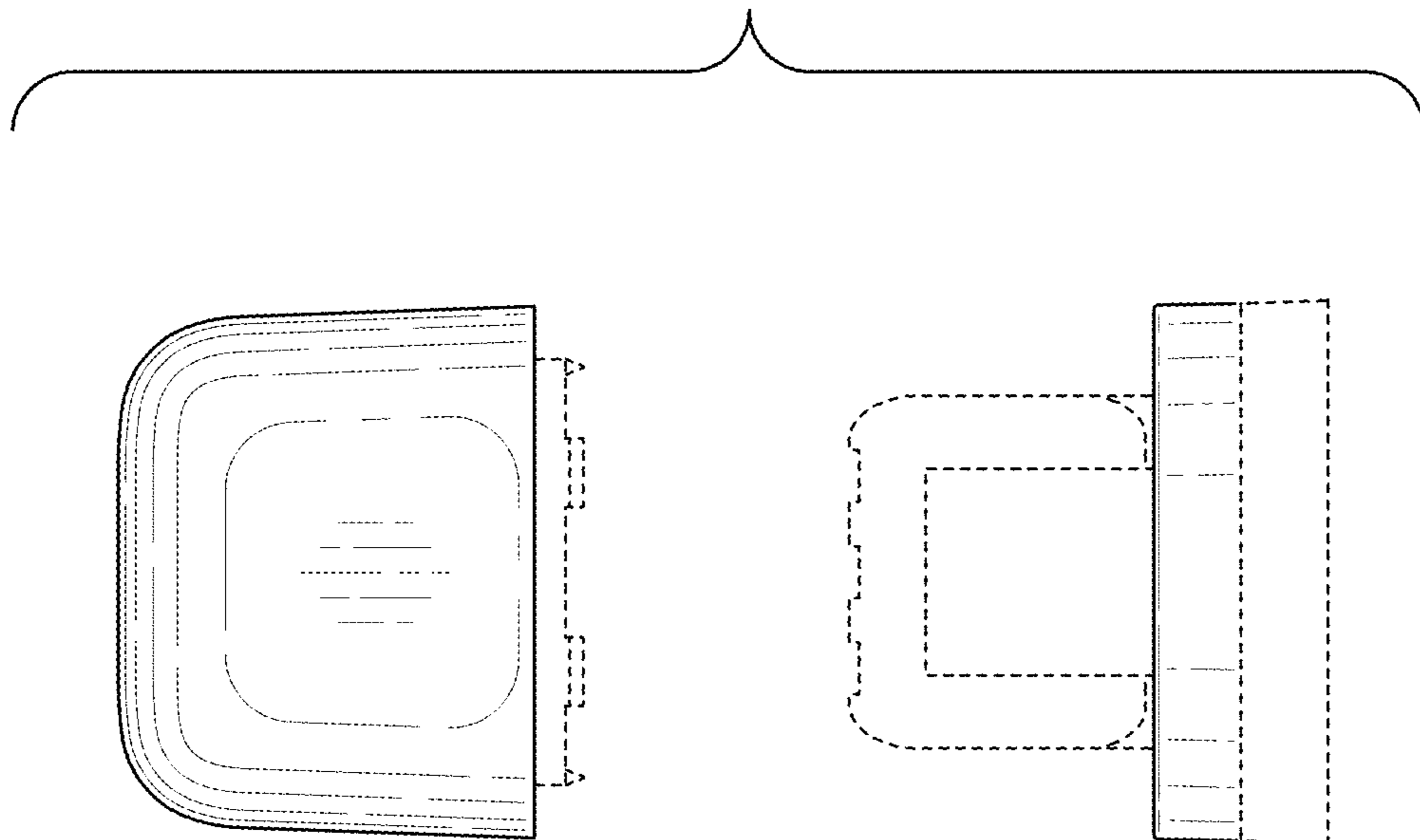



FIG. 7



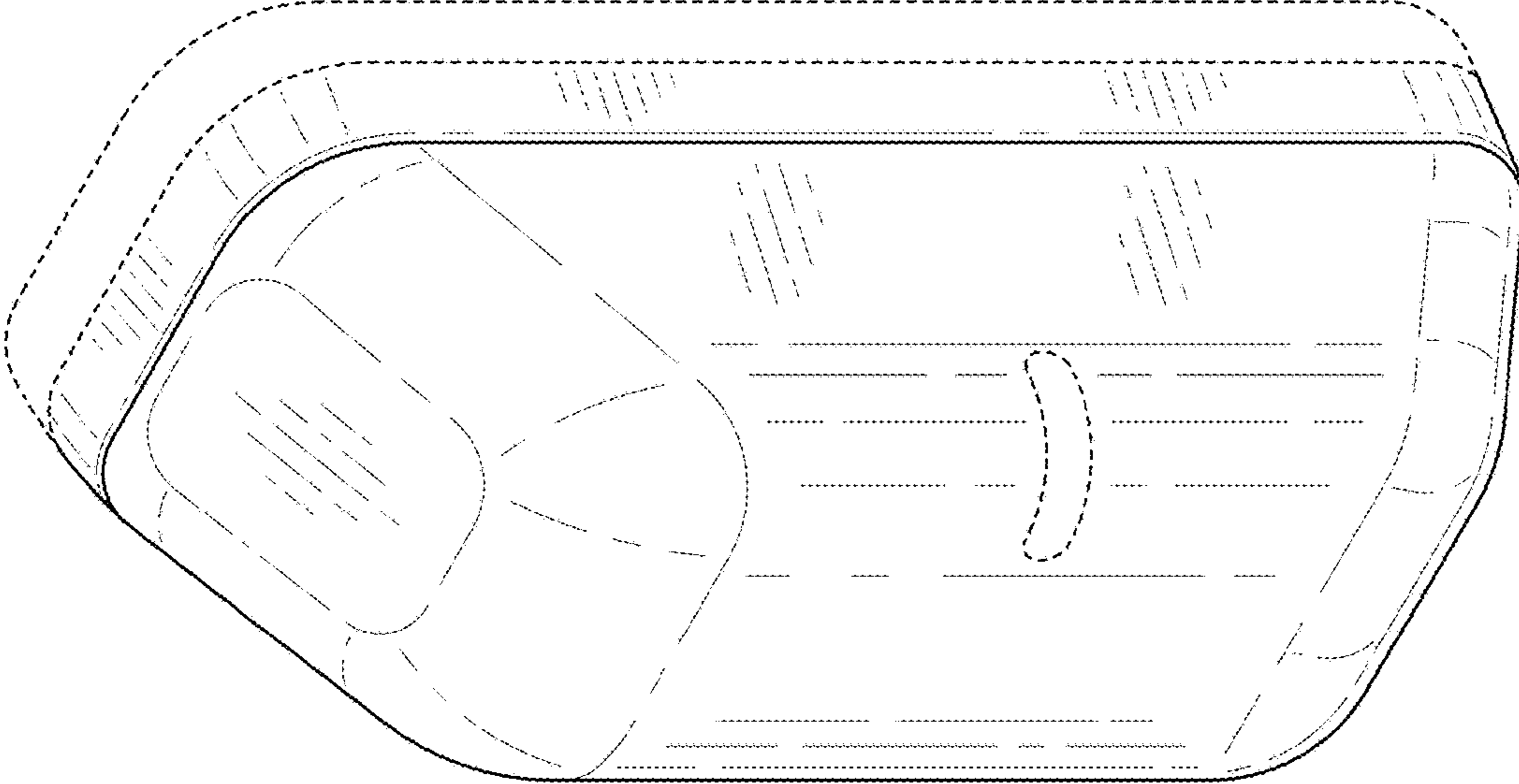

FIG. 8

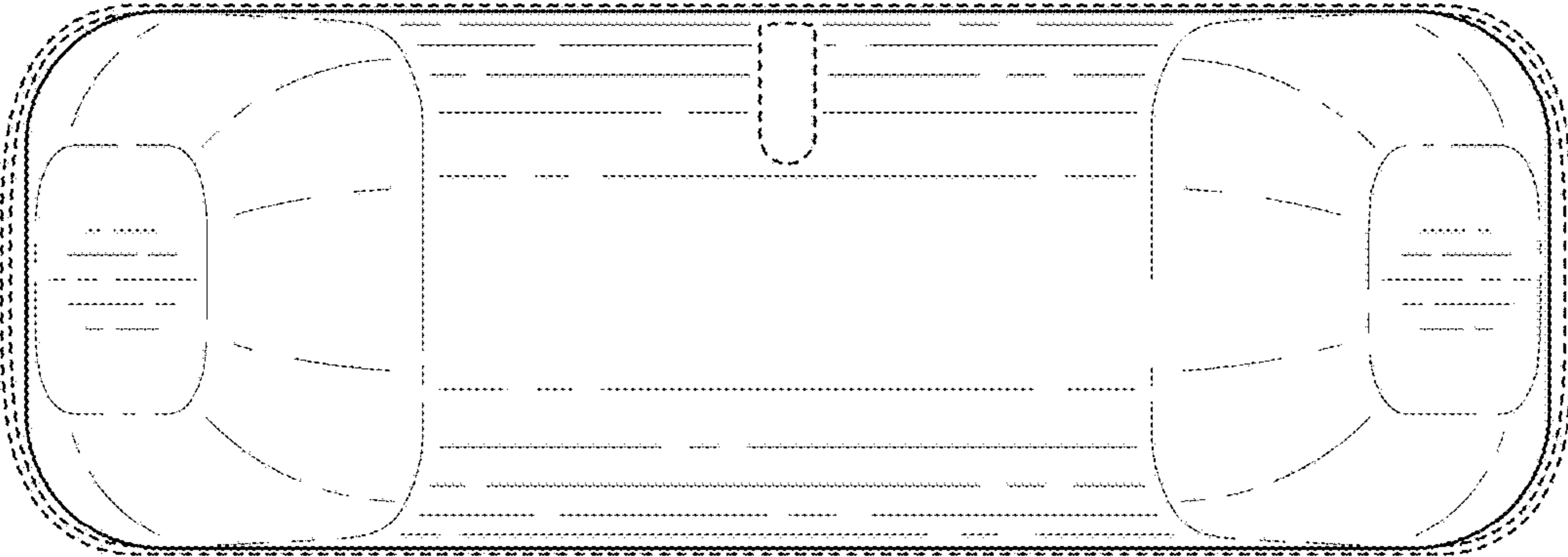

FIG. 9



FIG. 10

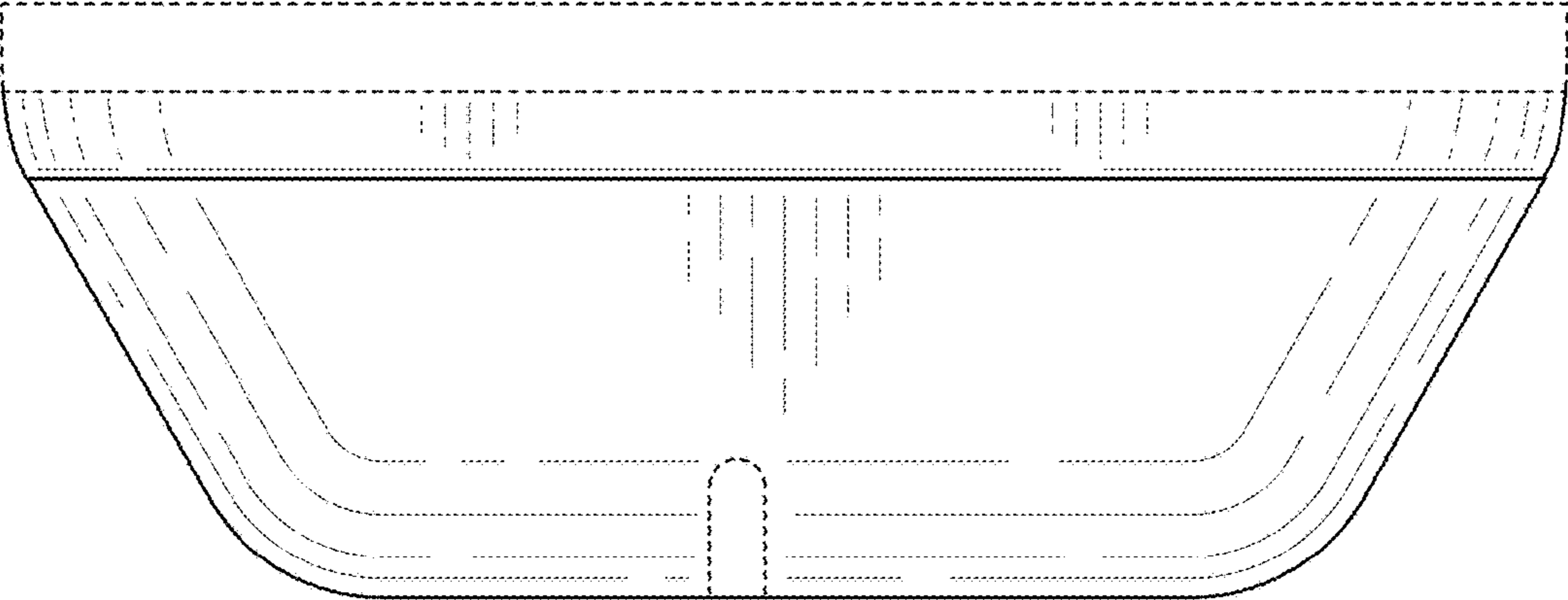

FIG. 11



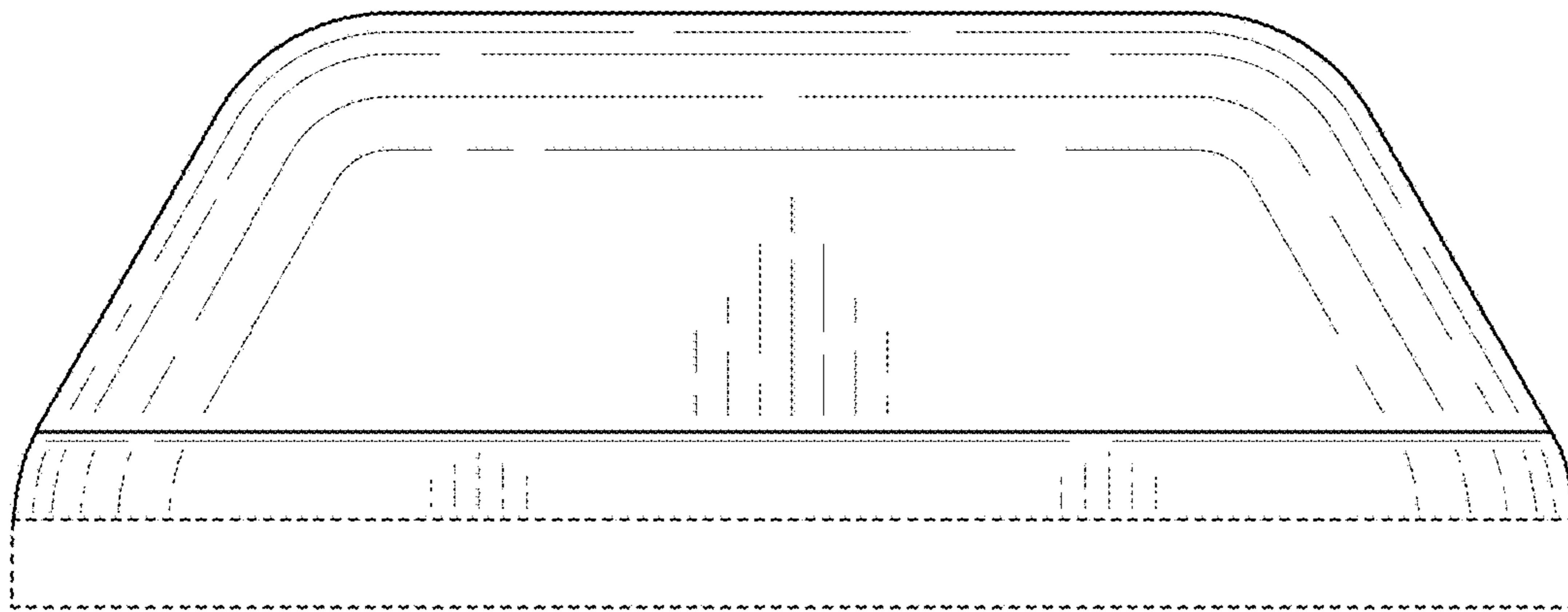

FIG. 12

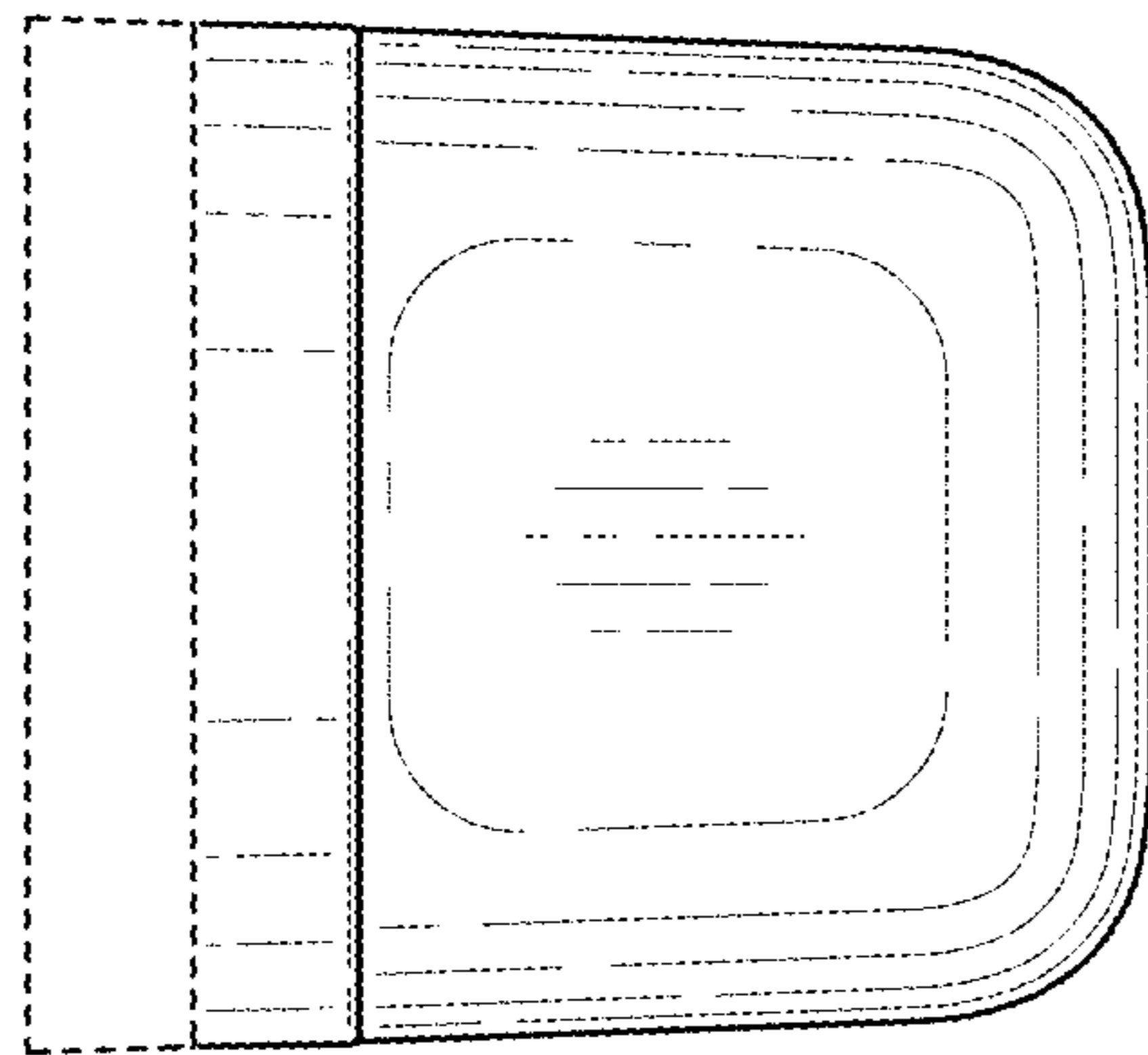

FIG. 13

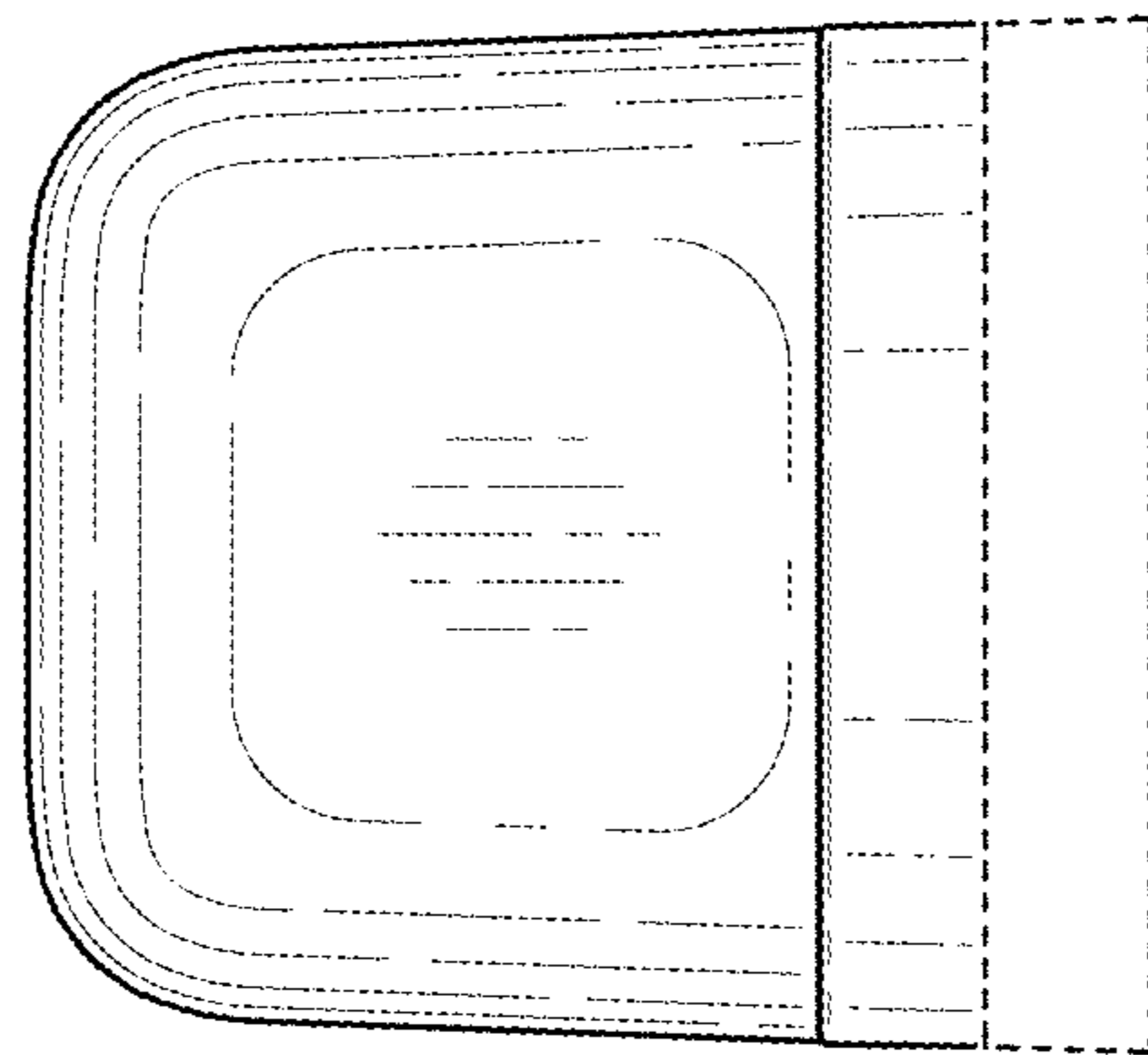

FIG. 14

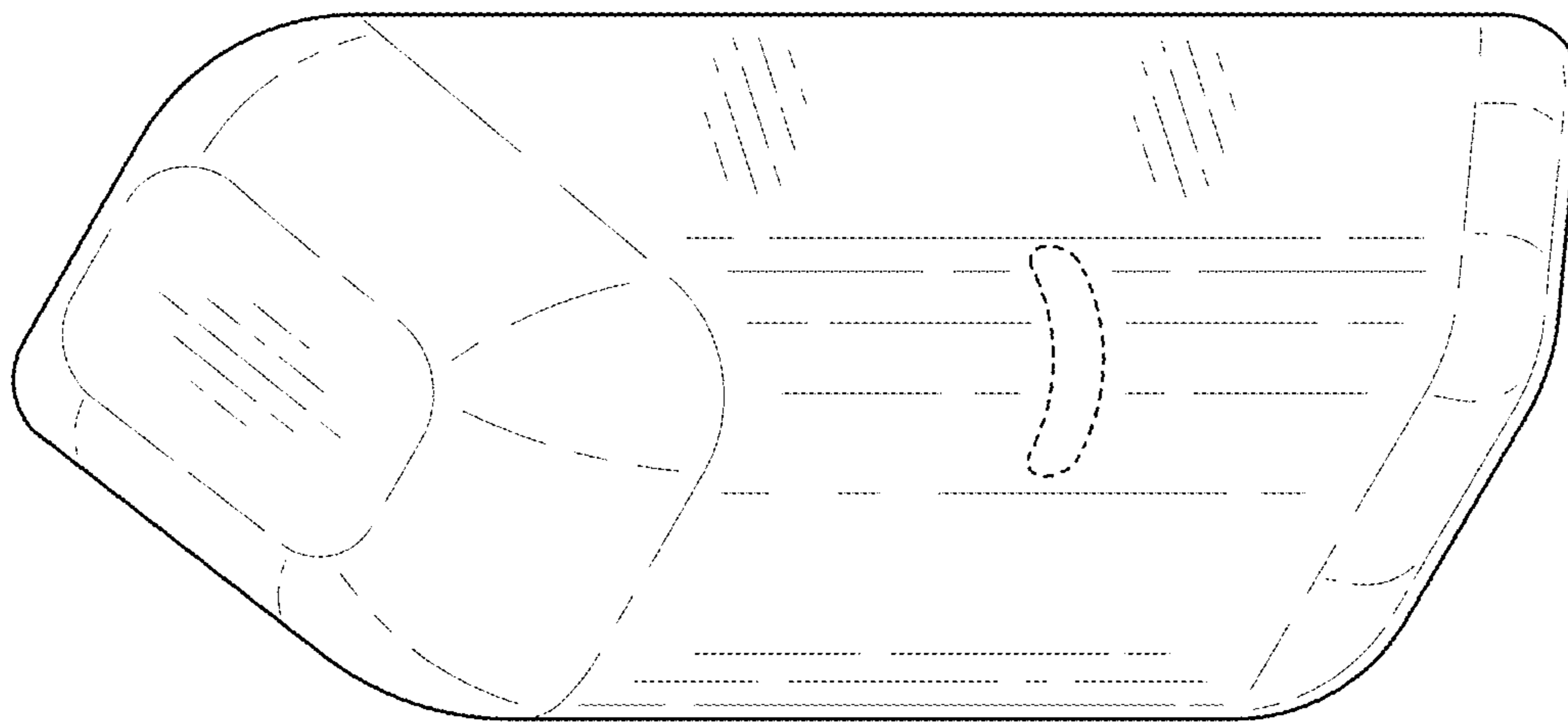

FIG. 15

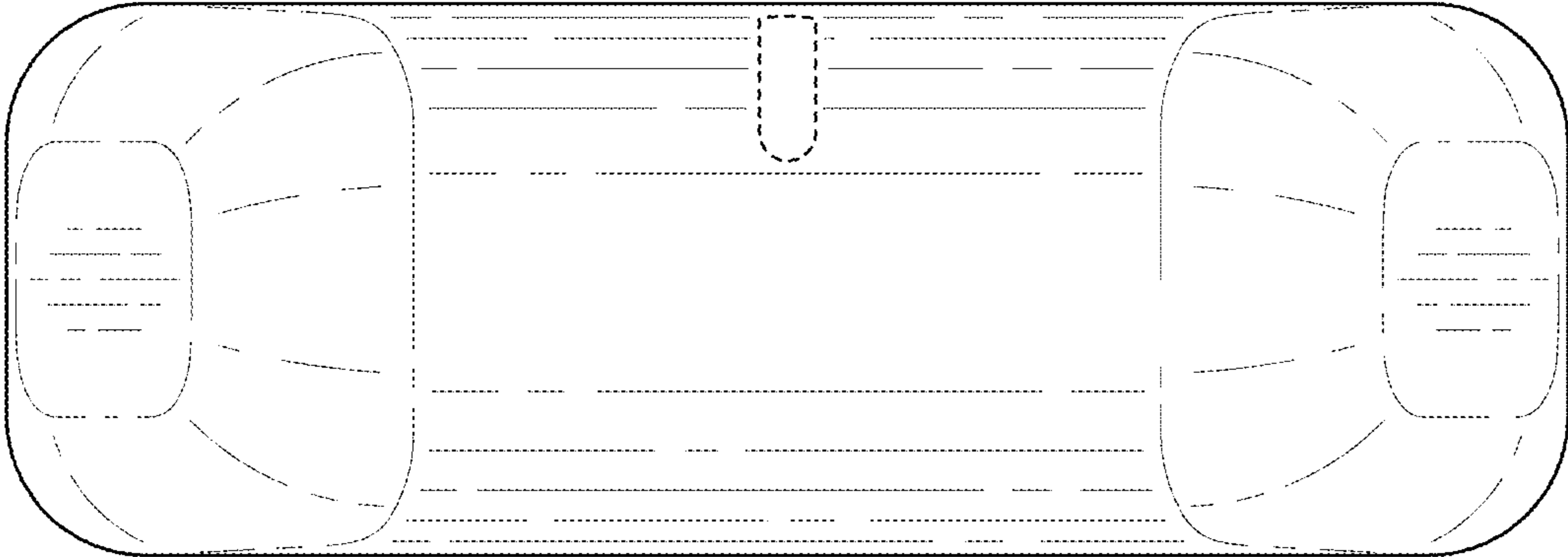

FIG. 16



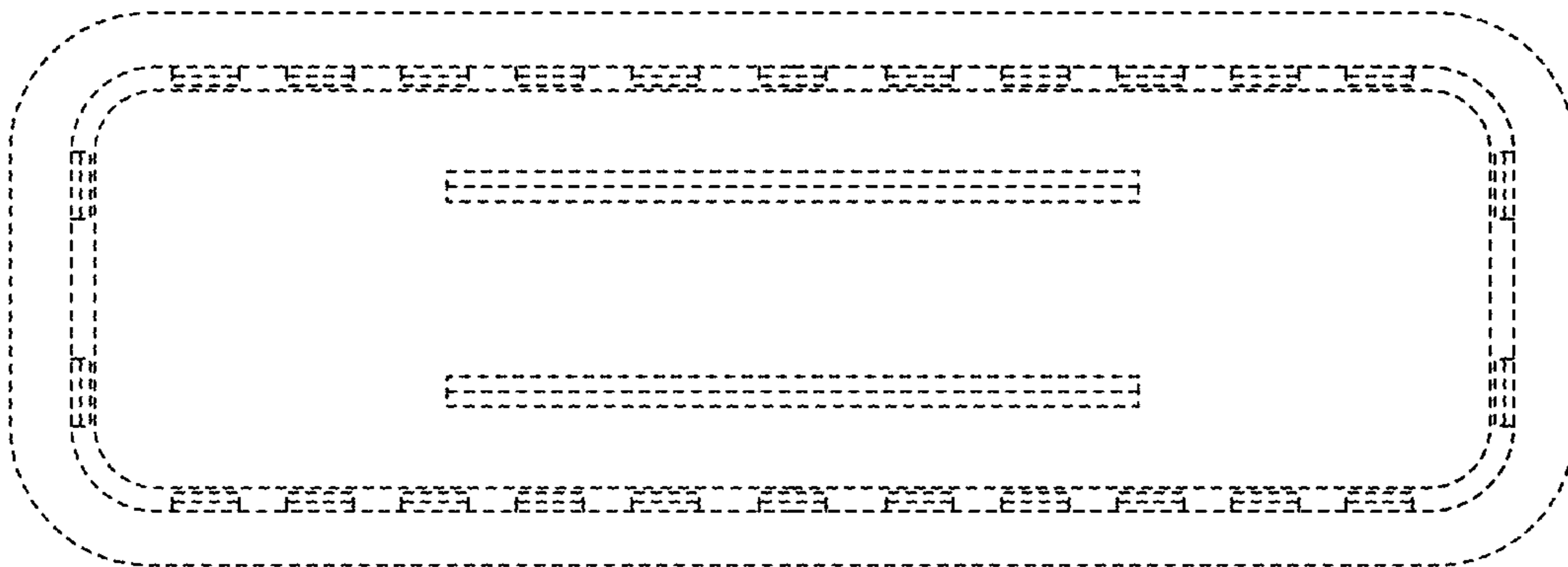

FIG. 17

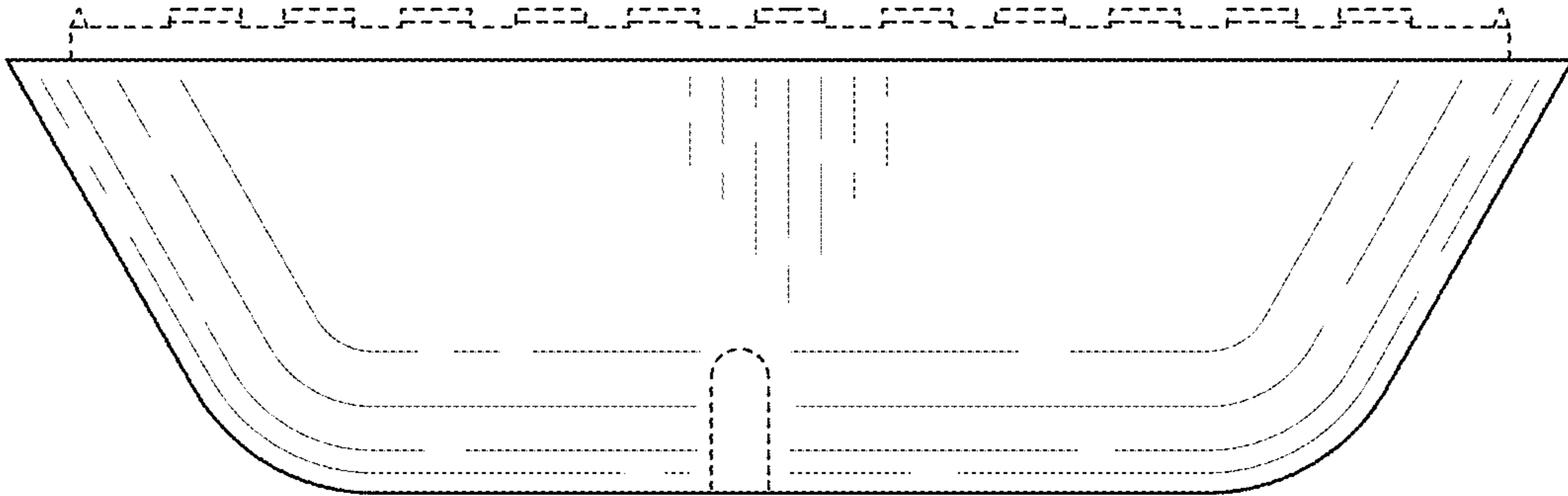

FIG. 18

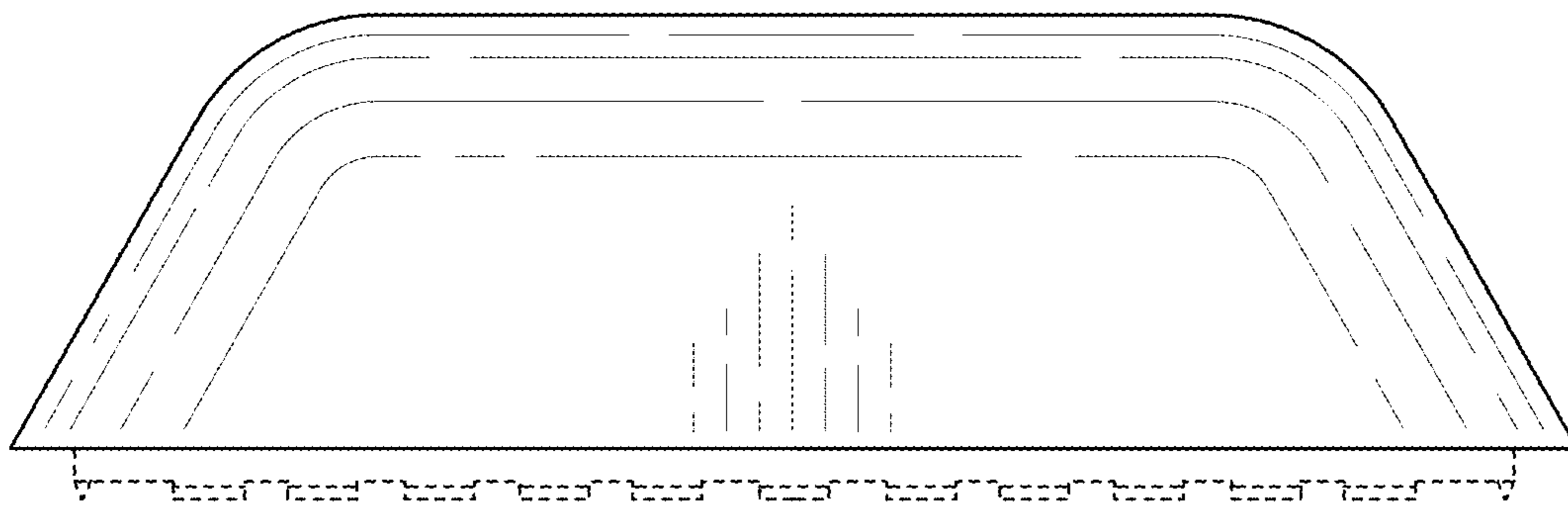

FIG. 19

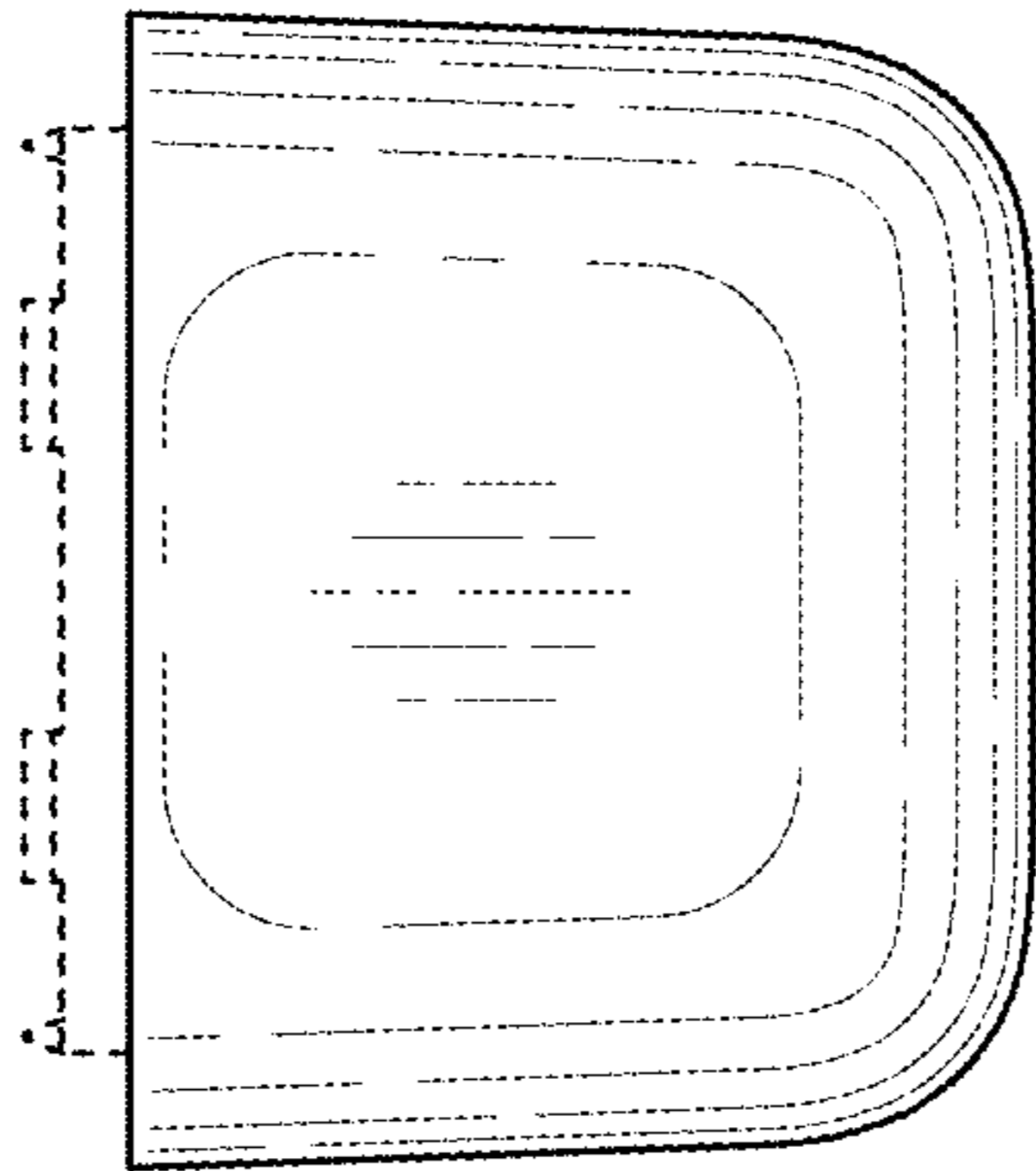

FIG. 20

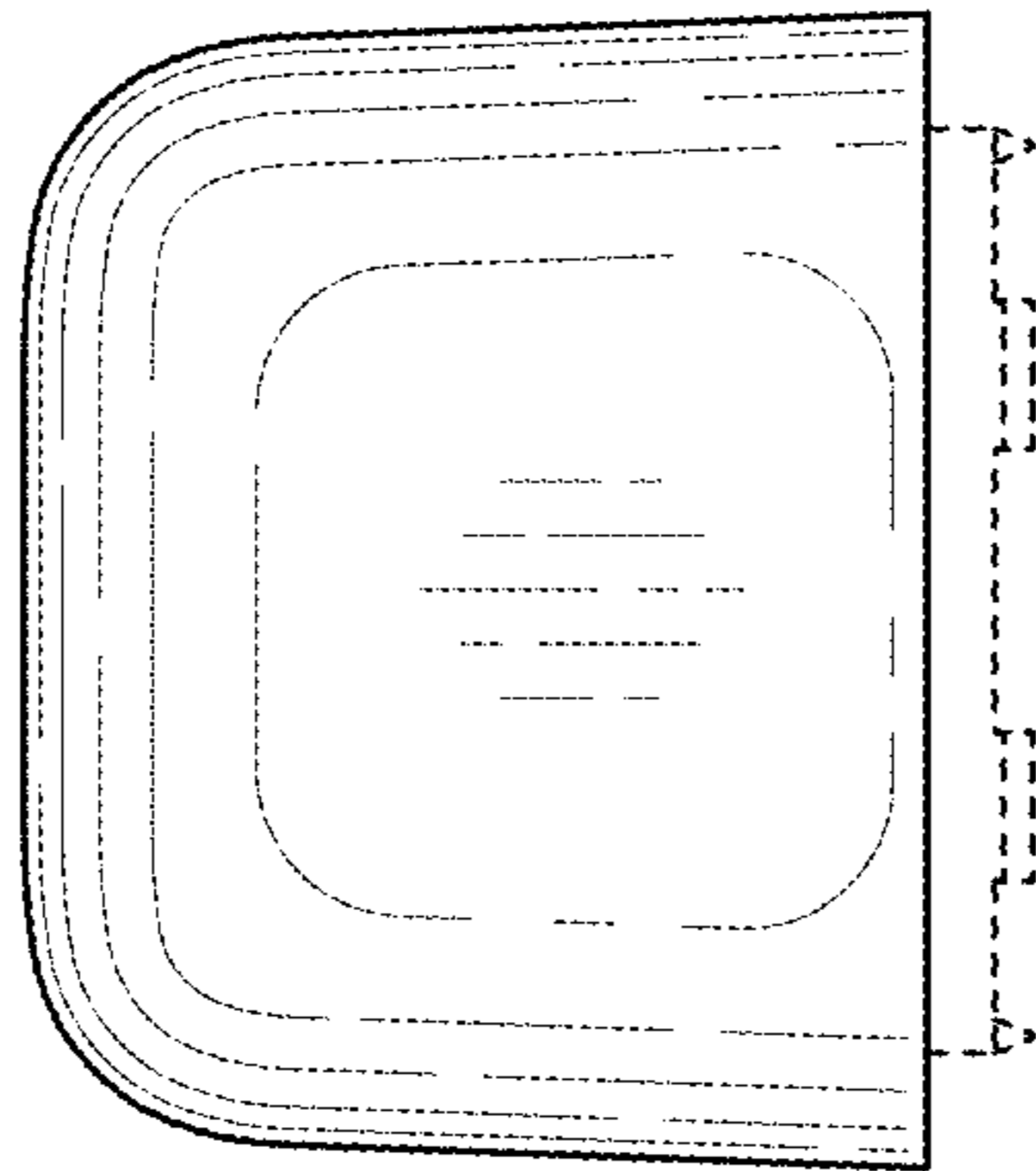

FIG. 21



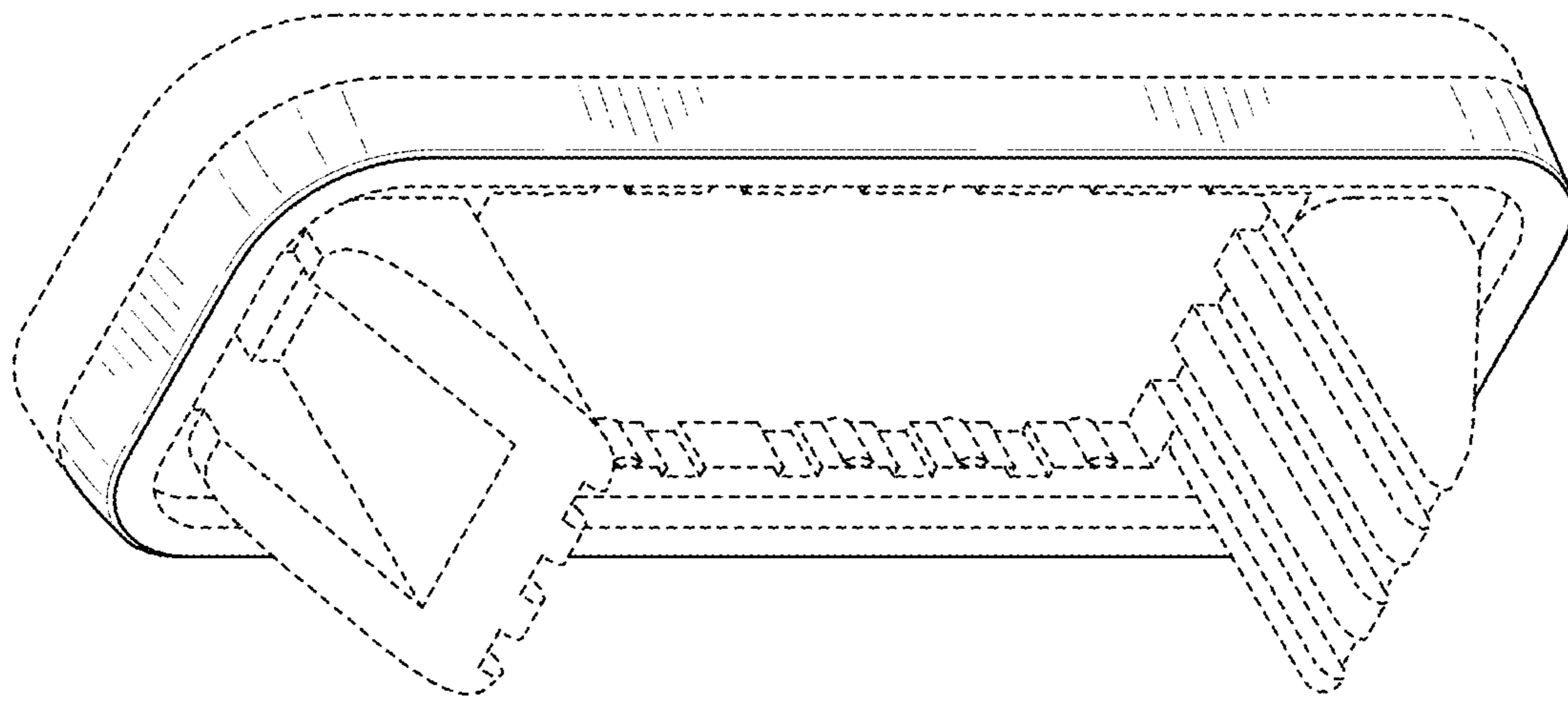

FIG. 22

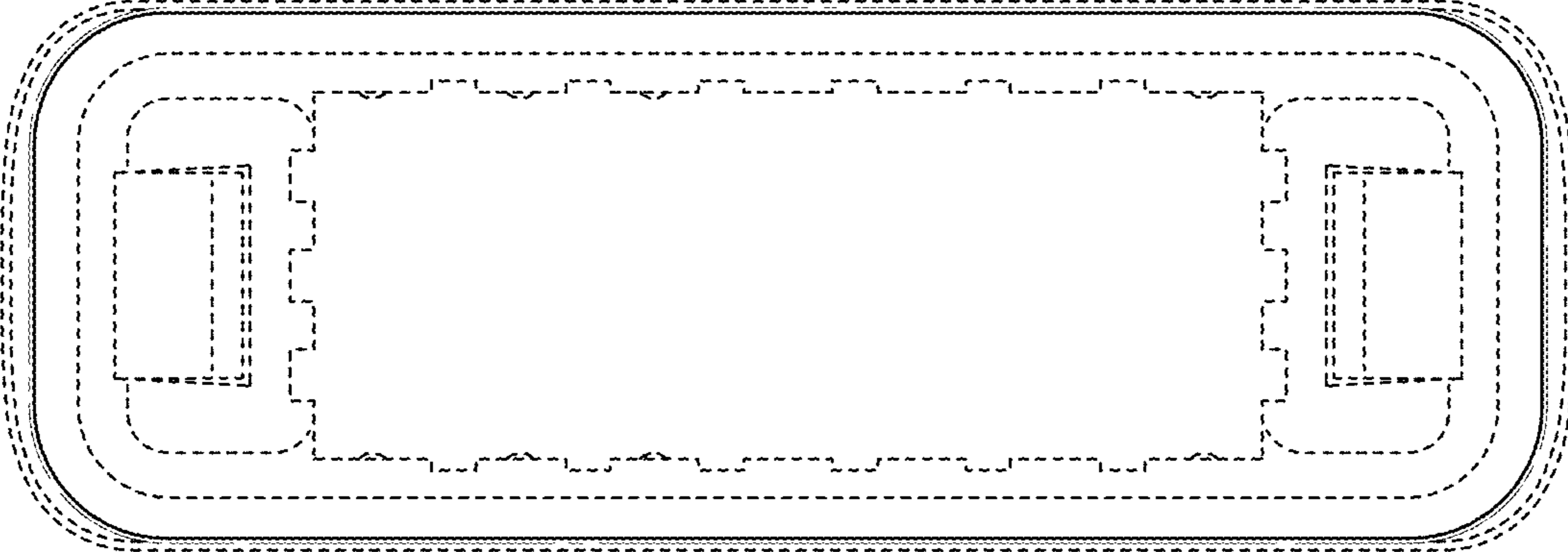

FIG. 23



FIG. 24

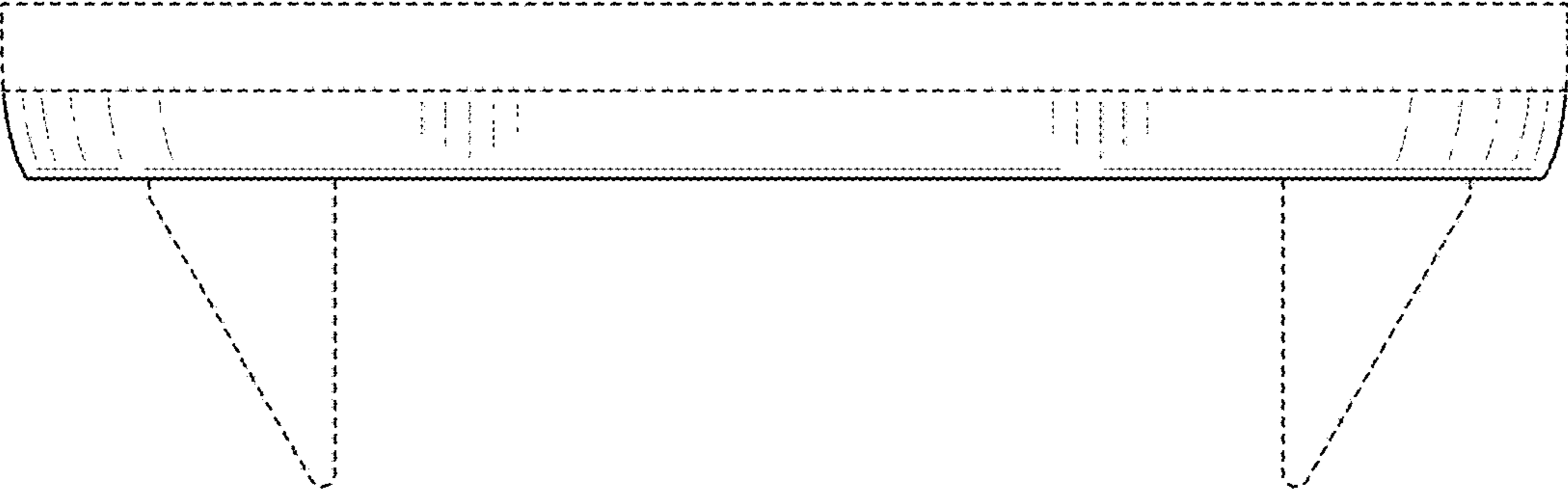

FIG. 25

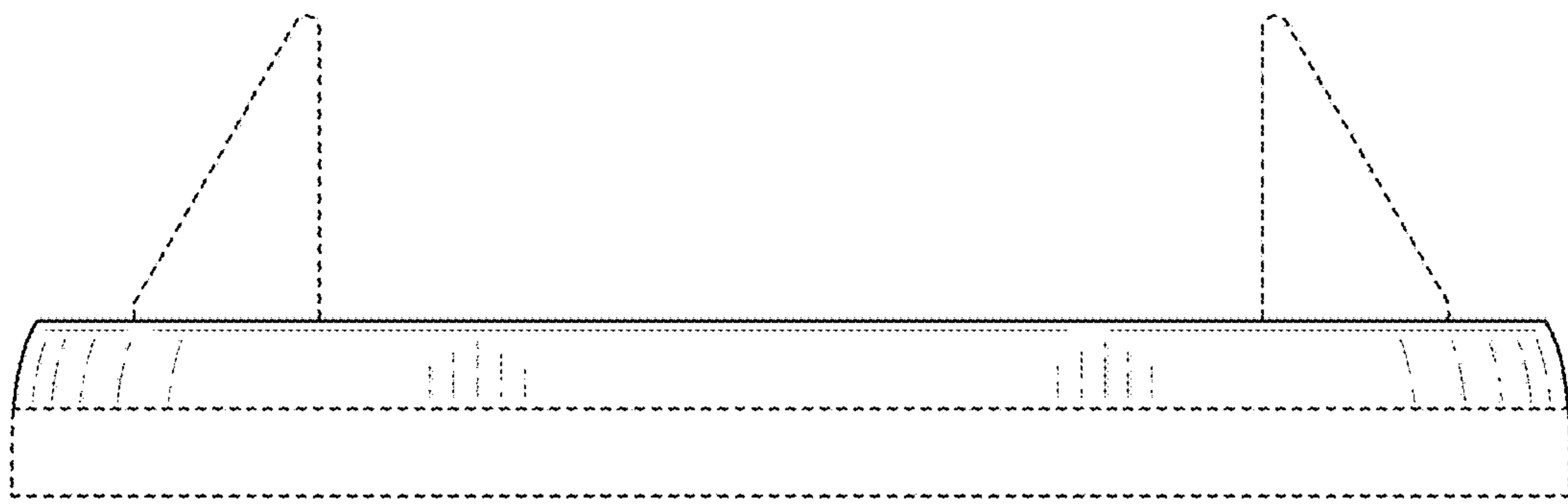

FIG. 26



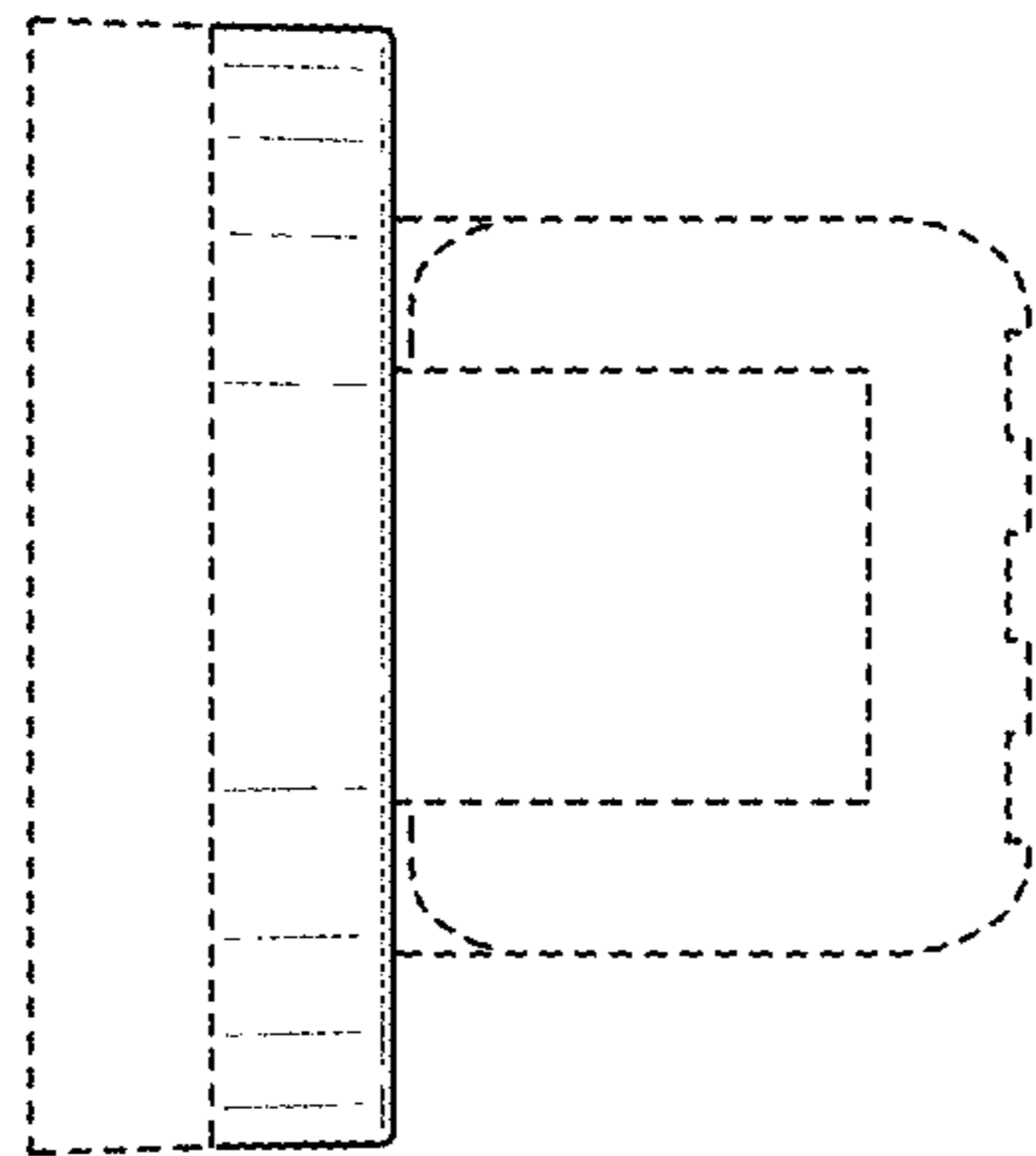

FIG. 27

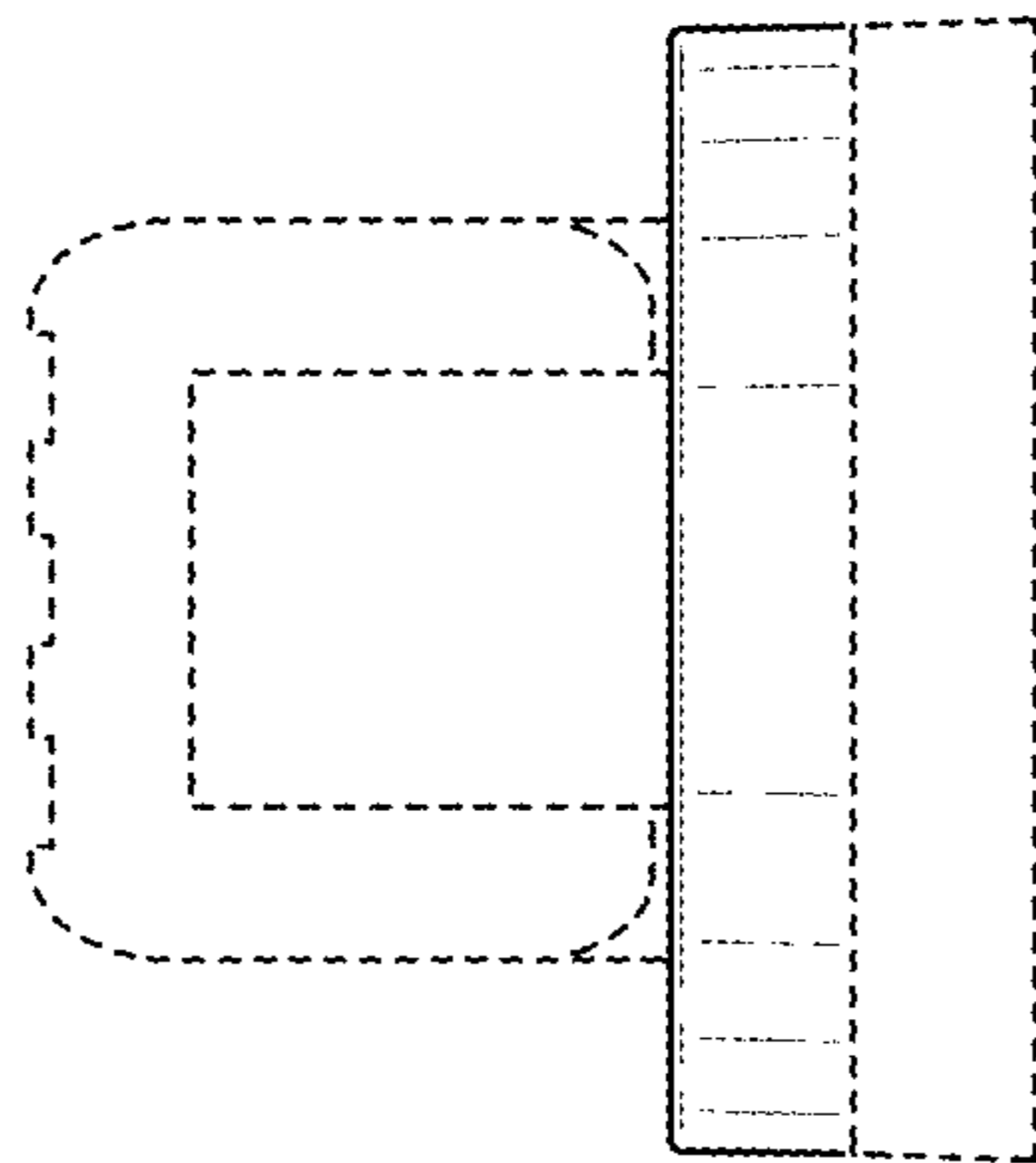

FIG. 28