

US00D967671S

(12) **United States Design Patent** (10) **Patent No.:** **US D967,671 S**
Grill (45) **Date of Patent:** **** Oct. 25, 2022**

(54) **SHAKER BALL** 6,379,032 B1 4/2002 Sorensen
7,014,175 B2 * 3/2006 Honnell B01J 19/30
261/DIG. 72
(71) Applicant: **Jason E. Grill**, Liberty Township, OH
(US) D666,047 S 8/2012 Lin
8,939,305 B2 1/2015 Meyers et al.
D782,874 S * 4/2017 Ross D7/378
(72) Inventor: **Jason E. Grill**, Liberty Township, OH
(US) 10,232,972 B1 3/2019 Grill
D864,662 S * 10/2019 Sorensen D7/378
D938,060 S * 12/2021 Takahori D24/215
D946,675 S * 3/2022 Chen D21/680
(**) Term: **15 Years** 2012/0305416 A1 12/2012 Miyabe et al.

(21) Appl. No.: **29/772,731**

(22) Filed: **Mar. 3, 2021**

(51) **LOC (13) Cl.** **31-00**

(52) **U.S. Cl.**
USPC **D7/412; D7/376; D7/378; D7/383;**
D7/384

(58) **Field of Classification Search**
USPC D7/372, 376–386, 412–413, 602, 629,
D7/665–666, 669, 679, 693–694;
D11/131; D21/680; D23/209; D24/215
CPC A21C 1/02; A21C 1/04; A23N 1/00; A23N
1/02; A47J 43/04; A47J 43/25; A47J
43/27; A47J 43/042; A47J 43/044; A47J
43/046; A47J 43/075; A47J 43/0716;
A47J 43/0722; A47J 43/0727; B01F 3/00;
B01F 3/0807; B01F 3/0853; B01F
13/047; B01F 13/0059; B01F 13/0064;
B02C 1/08; B02C 2/04; B02C 4/42;
B02C 4/142; B02C 4/143; B02C 4/423;
B02C 13/1835; B28C 5/10; B28C 5/12;
B28C 5/14; B28C 5/16; A63F 9/1288;
B01J 19/30
See application file for complete search history.

(56) **References Cited**

U.S. PATENT DOCUMENTS

3,800,442 A * 4/1974 Petrocelli A63F 9/1288
434/96
D232,238 S * 7/1974 La Borde D23/209
D432,453 S * 10/2000 Franzen D11/131

* cited by examiner

Primary Examiner — Ricky Pham

(74) *Attorney, Agent, or Firm* — The Law Office of
Patrick F. O'Reilly III, LLC

(57) **CLAIM**

The ornamental design for a shaker ball, as shown and described.

DESCRIPTION

FIG. 1 is a side-top perspective view of a shaker ball showing my new design;
FIG. 2 is a front elevational view of the shaker ball shown in FIG. 1;
FIG. 3 is a rear elevational view of the shaker ball shown in FIG. 1;
FIG. 4 is a left side elevational view of the shaker ball shown in FIG. 1;
FIG. 5 is a right side elevational view of the shaker ball shown in FIG. 1;
FIG. 6 is a top plan view of the shaker ball shown in FIG. 1; and,
FIG. 7 is a bottom plan view of the shaker ball shown in FIG. 1.

The broken line portions of the drawing figures are included to show unclaimed subject matter only and form no part of the claimed design. In particular, the logo on the top and bottom of the shaker ball shown in broken lines forms no part of the claimed invention.

1 Claim, 7 Drawing Sheets



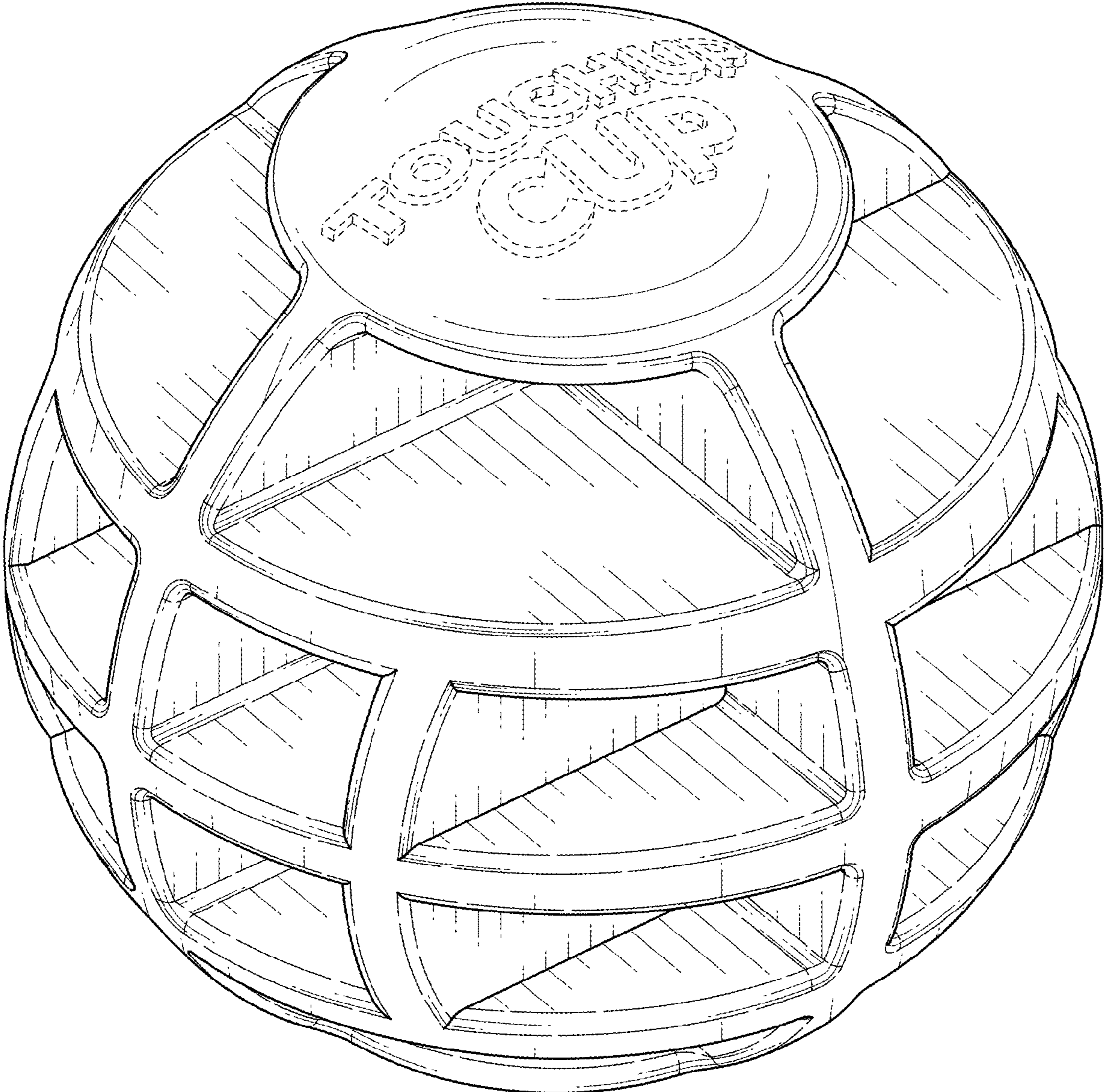

FIG. 1

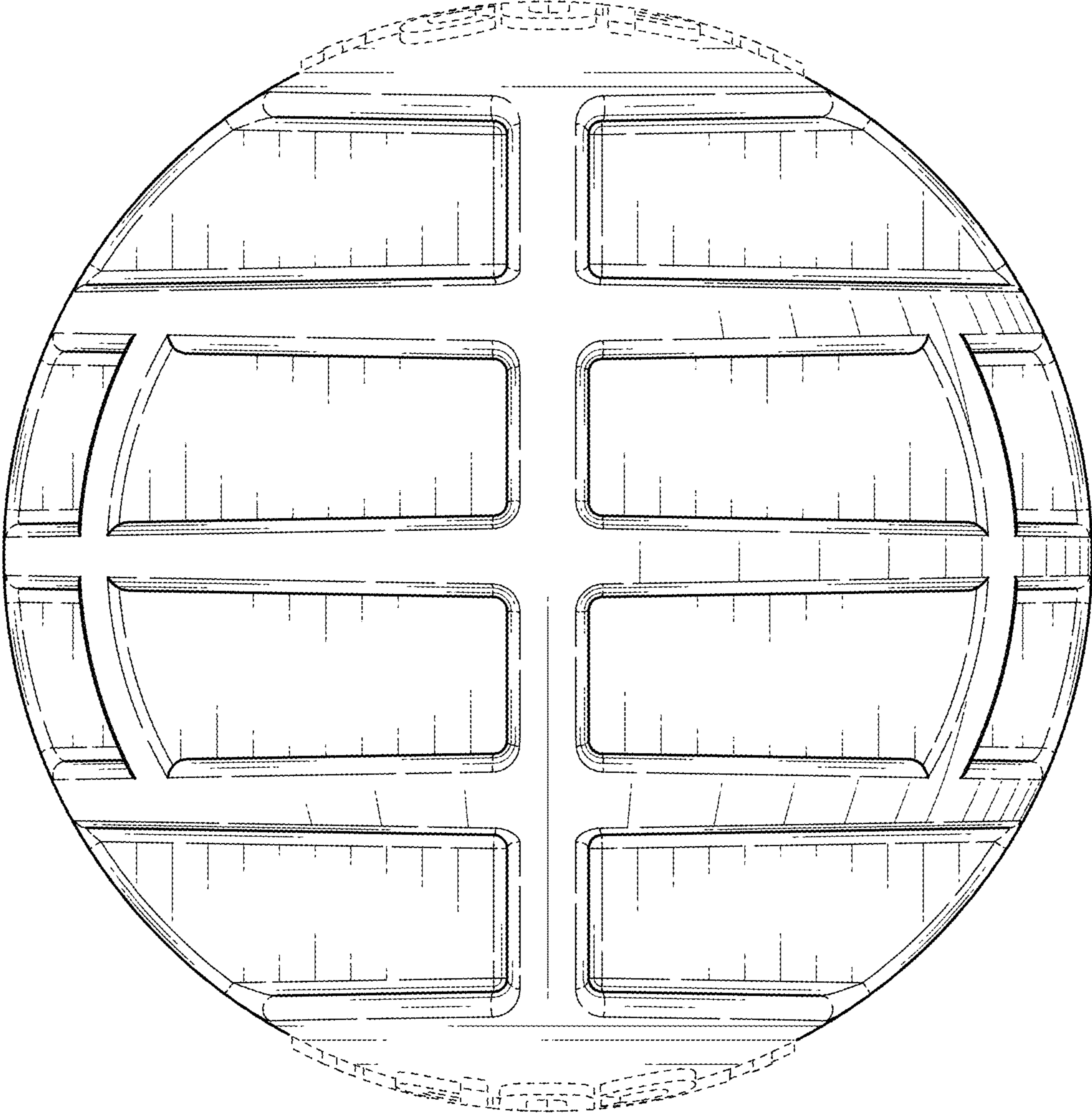

FIG. 2

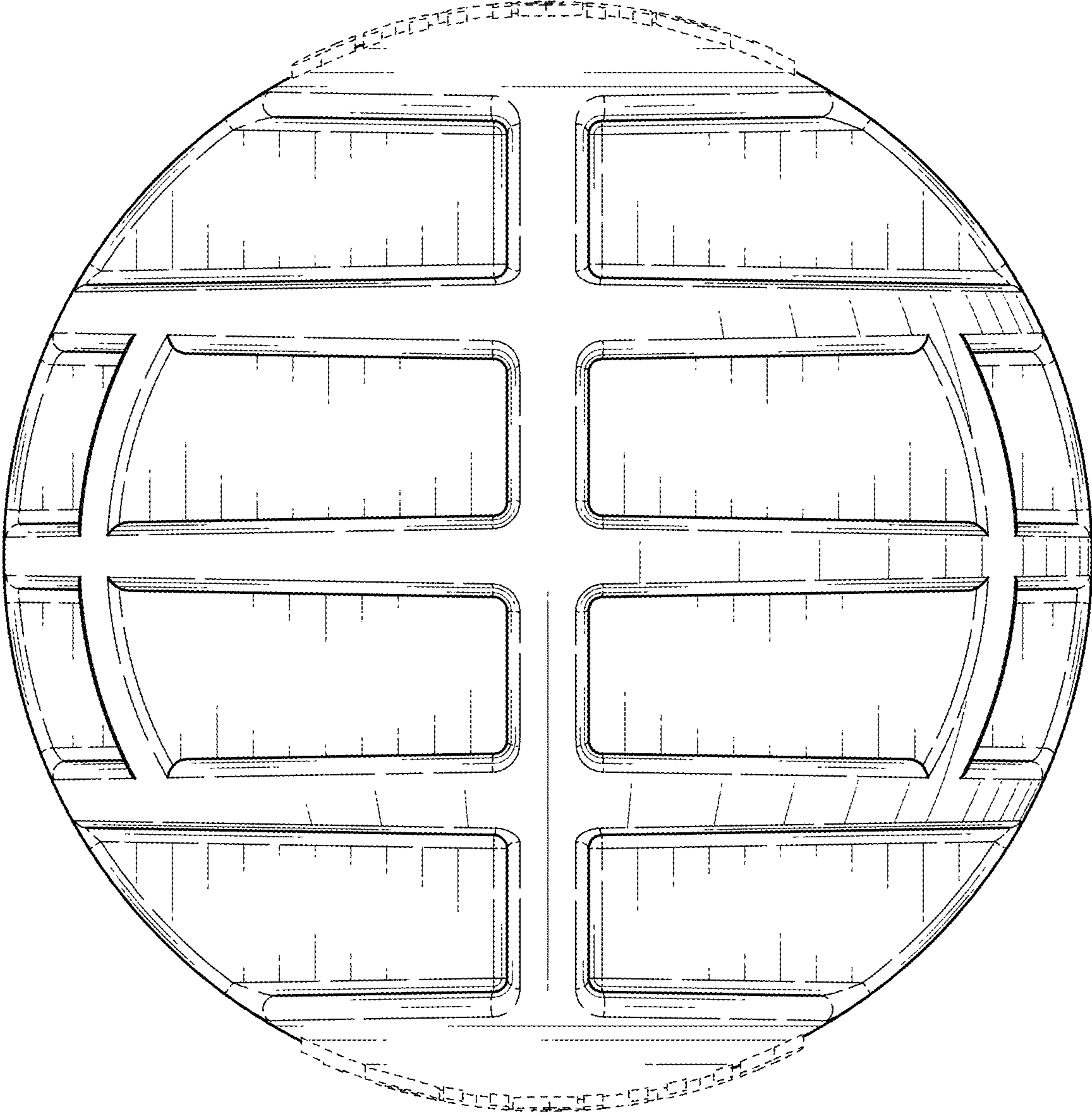

FIG. 3

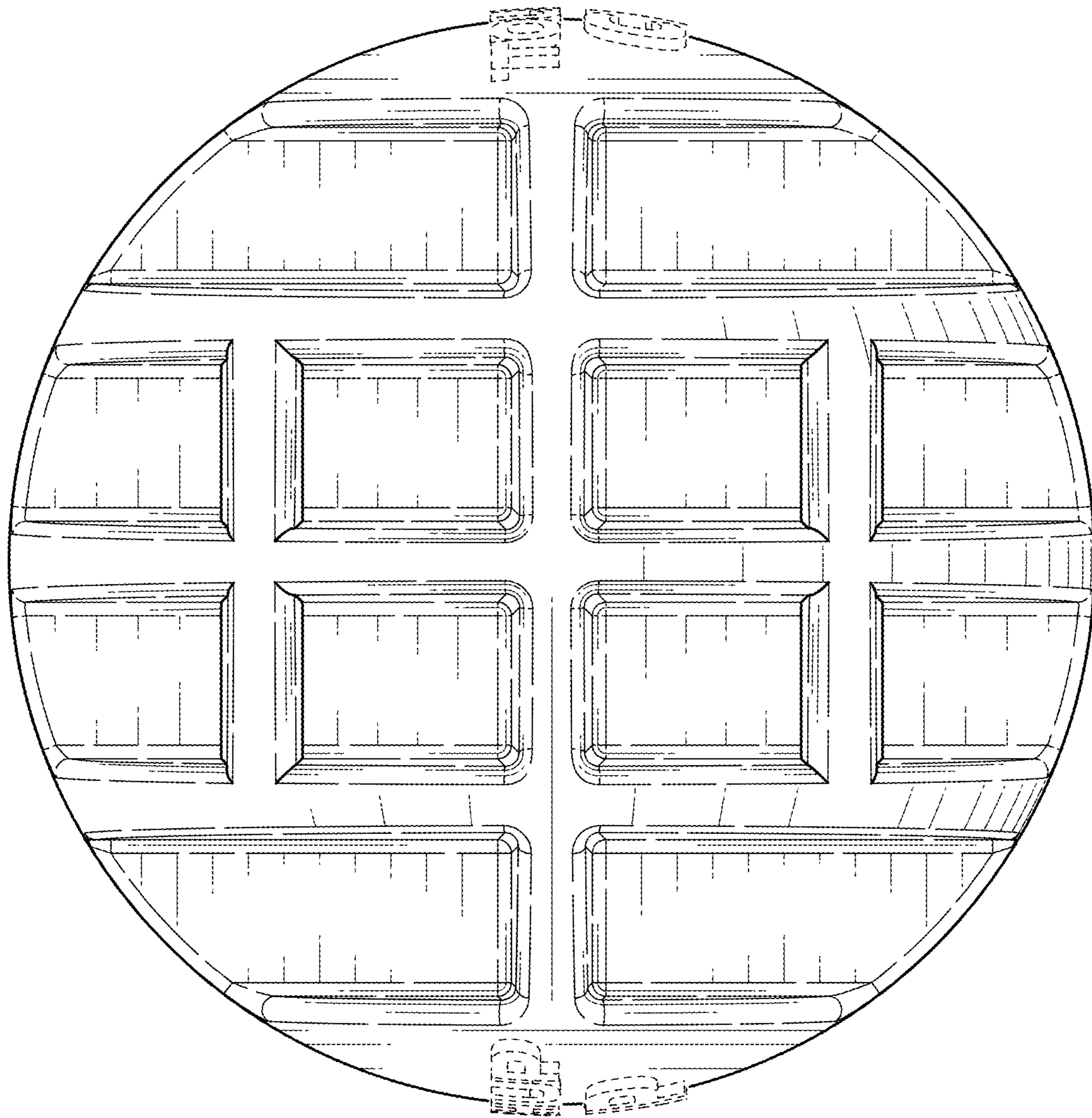

FIG. 4

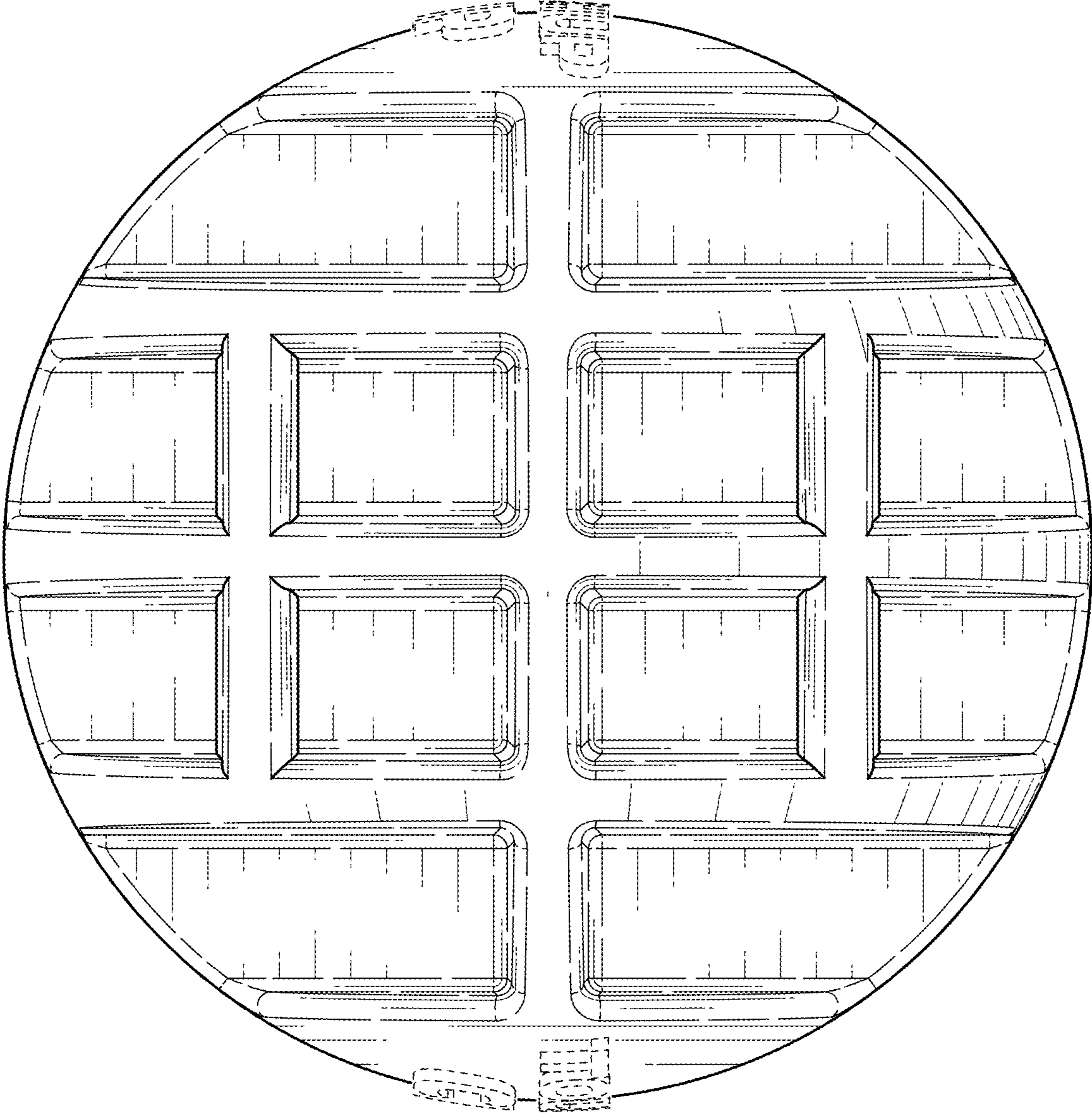

FIG. 5

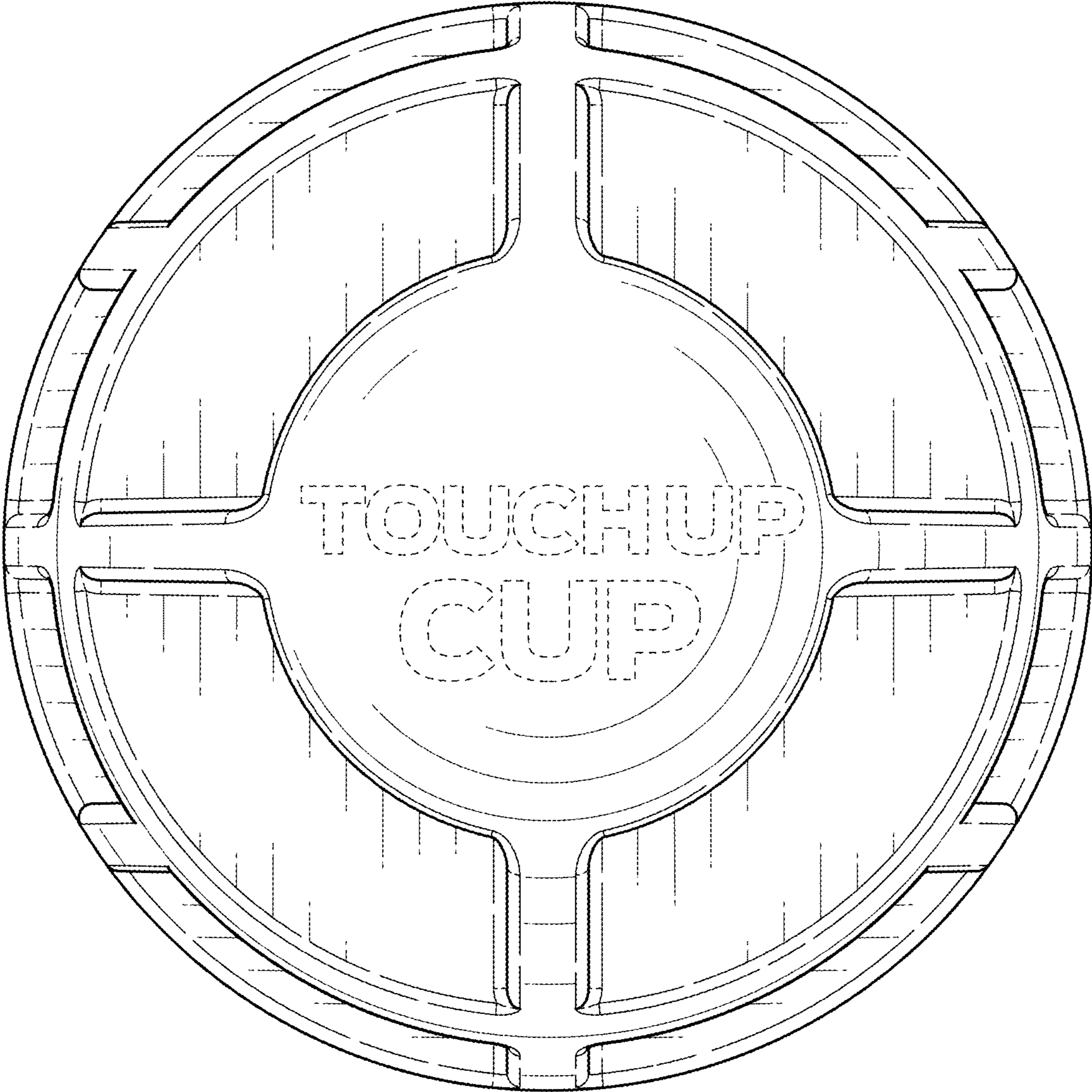

FIG. 6

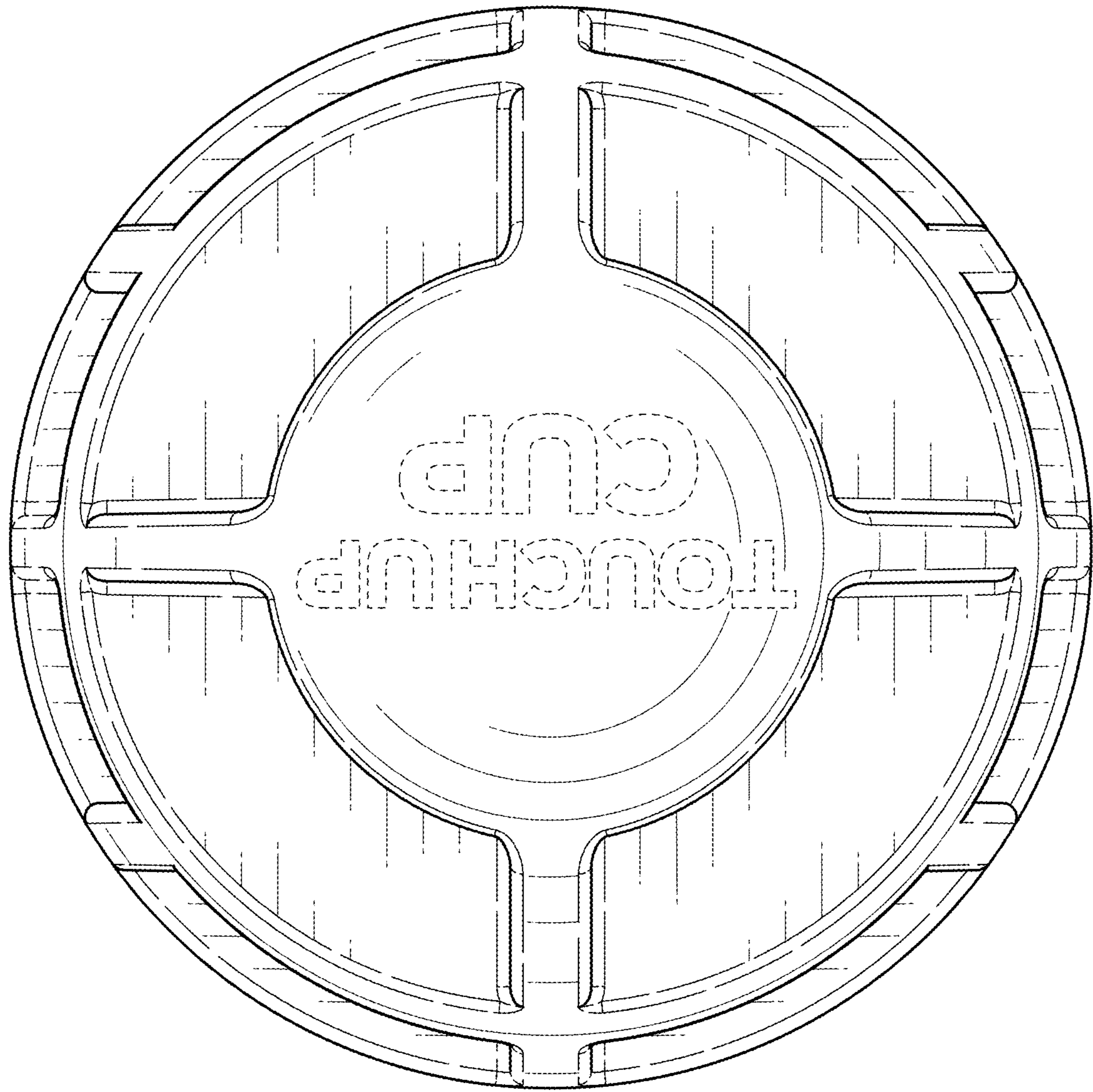

FIG. 7