



US00D967635S

(12) **United States Design Patent**
Zhou

(10) **Patent No.:** **US D967,635 S**
(45) **Date of Patent:** **** Oct. 25, 2022**

- (54) **KITCHEN ISLAND**
- (71) Applicant: **Shenzhen Pengyunfei Trading Co., Ltd.**, Shenzhen (CN)
- (72) Inventor: **Mingsong Zhou**, Shenzhen (CN)
- (73) Assignee: **Shenzhen Pengyunfei Trading Co., Ltd.**, Shenzhen (CN)
- (**) Term: **15 Years**
- (21) Appl. No.: **29/791,476**
- (22) Filed: **Jan. 12, 2022**
- (51) **LOC (13) Cl.** **06-01**
- (52) **U.S. Cl.**
USPC **D6/336; D6/686**
- (58) **Field of Classification Search**
USPC D6/329, 657, 662.1, 672, 673, 675,
D6/675.1, 684, 685, 686, 691, 691.1,
D6/691.9, 694, 698, 335, 336, 338
CPC A47B 77/022; A47B 13/00; A47B 7/00;
A47B 33/00
See application file for complete search history.

D746,614 S *	1/2016	Sheppard	D6/657
D787,246 S	5/2017	Price et al.	
D787,247 S	5/2017	Price et al.	
D854,864 S *	7/2019	Lim	D6/684
D869,867 S *	12/2019	Davis	D6/349
D893,220 S *	8/2020	Everson	D6/657
D946,330 S *	3/2022	Li	D6/691
D950,282 S *	5/2022	Stafford	D6/686

OTHER PUBLICATIONS

“AWQM 3 Piece Bar Table Set.” Found online Jul. 19, 2022 at www.amazon.com. Product first available Oct. 26, 2021. Retrieved from URL: <https://www.amazon.com/AWQM-Industrial-Storage-Counter-Kitchen/dp/B09KC9Z8DF> (Year: 2021).*

“DKLGG 3 Piece Dinging Table Set.” Found online Jul. 19, 2022 at www.amazon.com. Product first available Oct. 28, 2021. Retrieved from URL: <https://www.amazon.com/DKLG-G-Dinging-Storage-Shelves-Restaurant/dp/B09KKTJJD1> (Year: 2021).*

(Continued)

Primary Examiner — Mary Ann Calabrese
Assistant Examiner — Katelin G Kloberg
(74) *Attorney, Agent, or Firm* — Jeenam Park

(57) **CLAIM**

The ornamental design for a kitchen island, as shown and described.

DESCRIPTION

FIG. 1 is a perspective view of a kitchen island, showing my new design;
FIG. 2 is a front view thereof;
FIG. 3 is a rear view thereof;
FIG. 4 is a left side view thereof;
FIG. 5 is a right side view thereof;
FIG. 6 is a top plan view thereof; and,
FIG. 7 is a bottom plan view thereof.

1 Claim, 7 Drawing Sheets

(56) **References Cited**

U.S. PATENT DOCUMENTS

1,538,393 A *	5/1925	Fowler	A47B 3/12
			D6/691.1
D273,726 S *	5/1984	Valenzuela	D23/278
D326,971 S *	6/1992	Leis	D6/675.1
D377,124 S *	1/1997	Stirling	D6/552
D430,752 S *	9/2000	Hazen	D6/662.1
D669,706 S *	10/2012	Zambelli	D6/662.1
D669,707 S *	10/2012	Zambelli	D6/662.1
D699,452 S *	2/2014	Clodfelter	D6/338
D739,151 S *	9/2015	Lee	D6/338

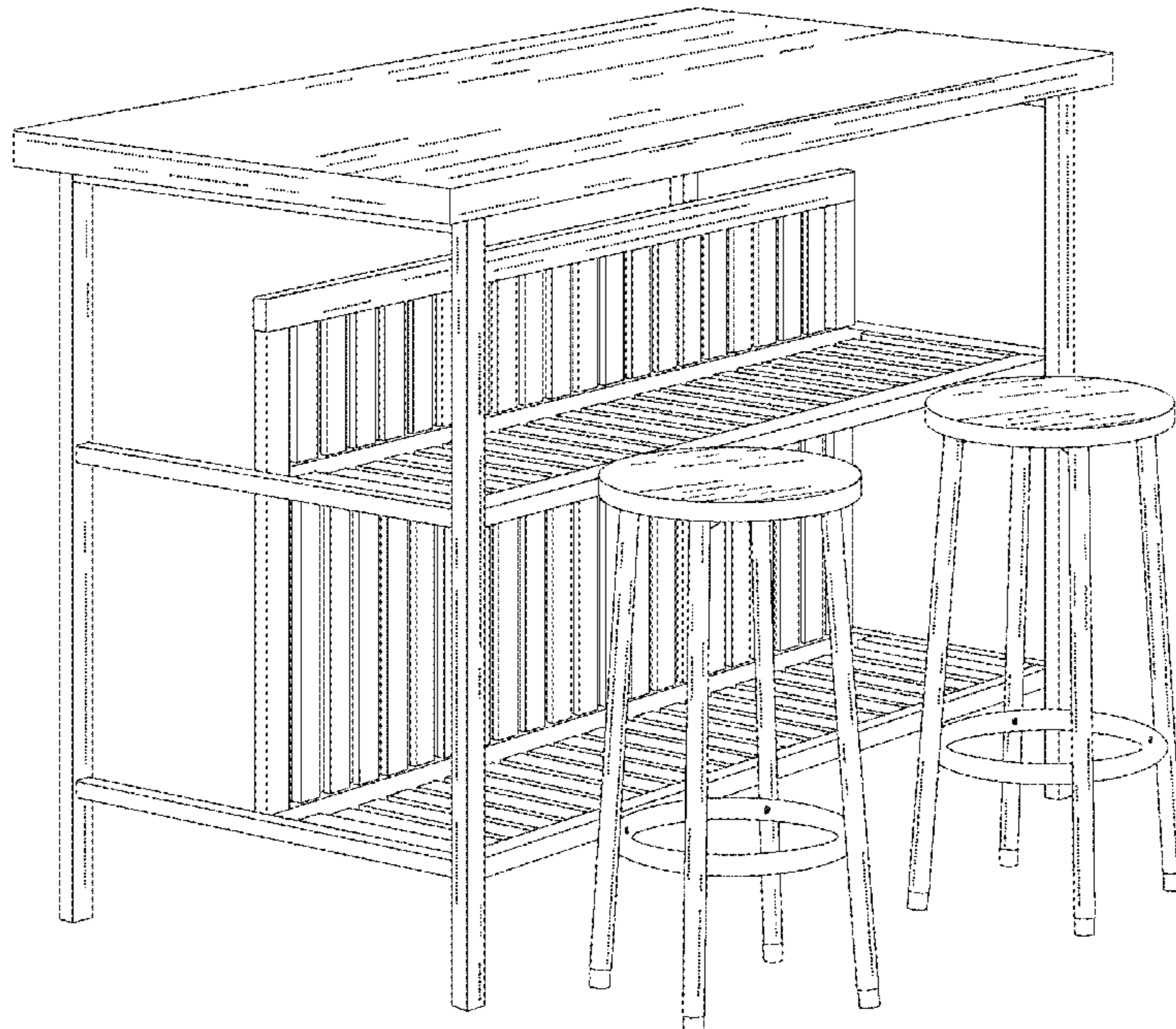

(56)

References Cited

OTHER PUBLICATIONS

“Recaceik 3 Piece Pub Table Set.” Found online Jul. 19, 2022 at [www.amazon.com](https://www.amazon.com/Recaceik-Rectangular-Counter-Storage-Kitchen/dp/B09WKXR5J). Product first available Mar. 26, 2022. Retrieved from URL: <https://www.amazon.com/Recaceik-Rectangular-Counter-Storage-Kitchen/dp/B09WKXR5J> (Year: 2022).*

“Greenwood Rustic Brown Kitchen Island Set.” Found online Jul. 19, 2022 at [www.homedepot.com](https://www.homedepot.com/p/Greenwood-Rustic-Brown-Kitchen-Island-Set-with-Faux-Marble-Top-and-2-Stools-KIMW368357131/319220597). Customer question asked Jun. 23, 2022. Retrieved from URL: <https://www.homedepot.com/p/Greenwood-Rustic-Brown-Kitchen-Island-Set-with-Faux-Marble-Top-and-2-Stools-KIMW368357131/319220597> (Year: 2022).*

* cited by examiner

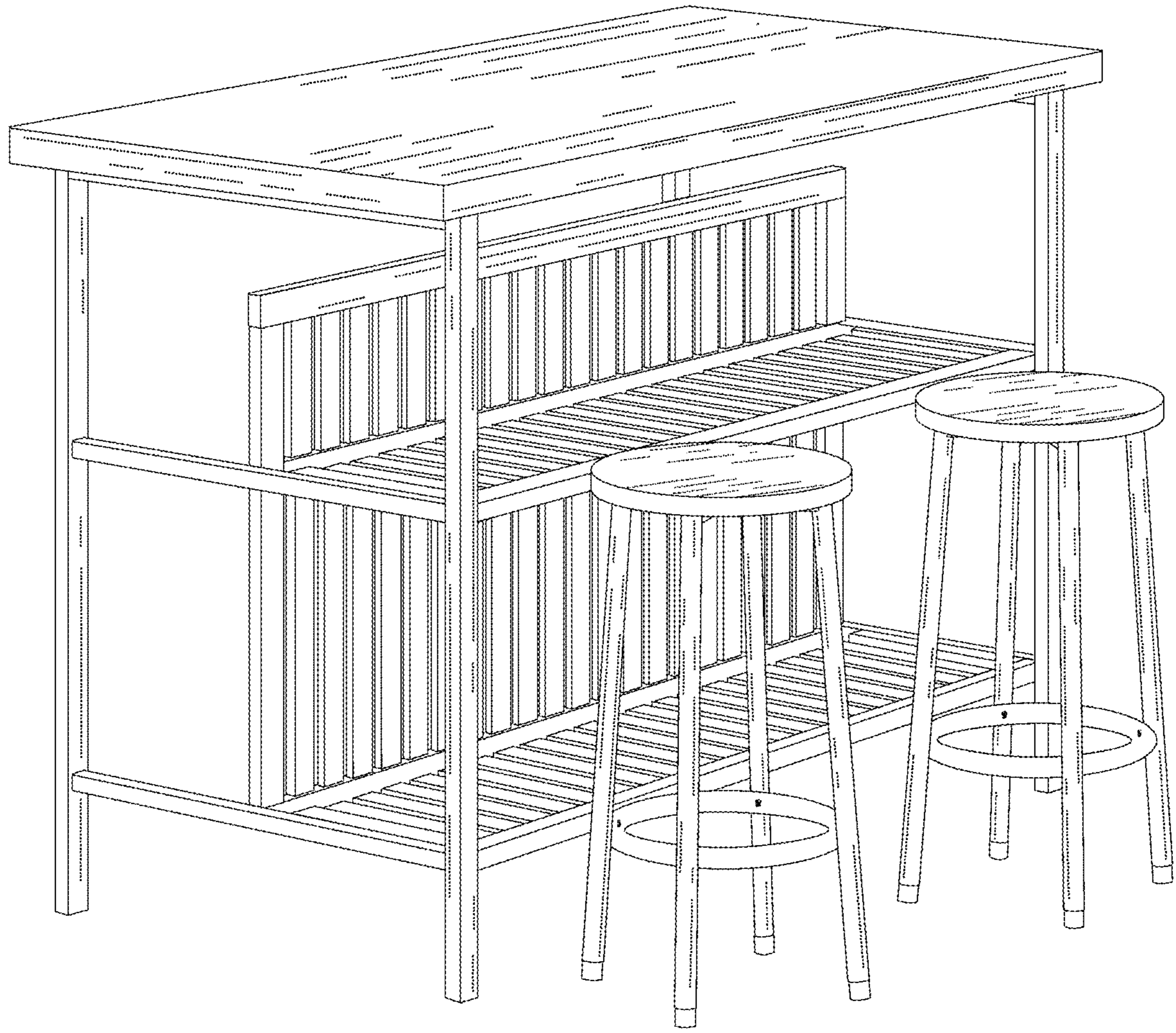

FIG. 1

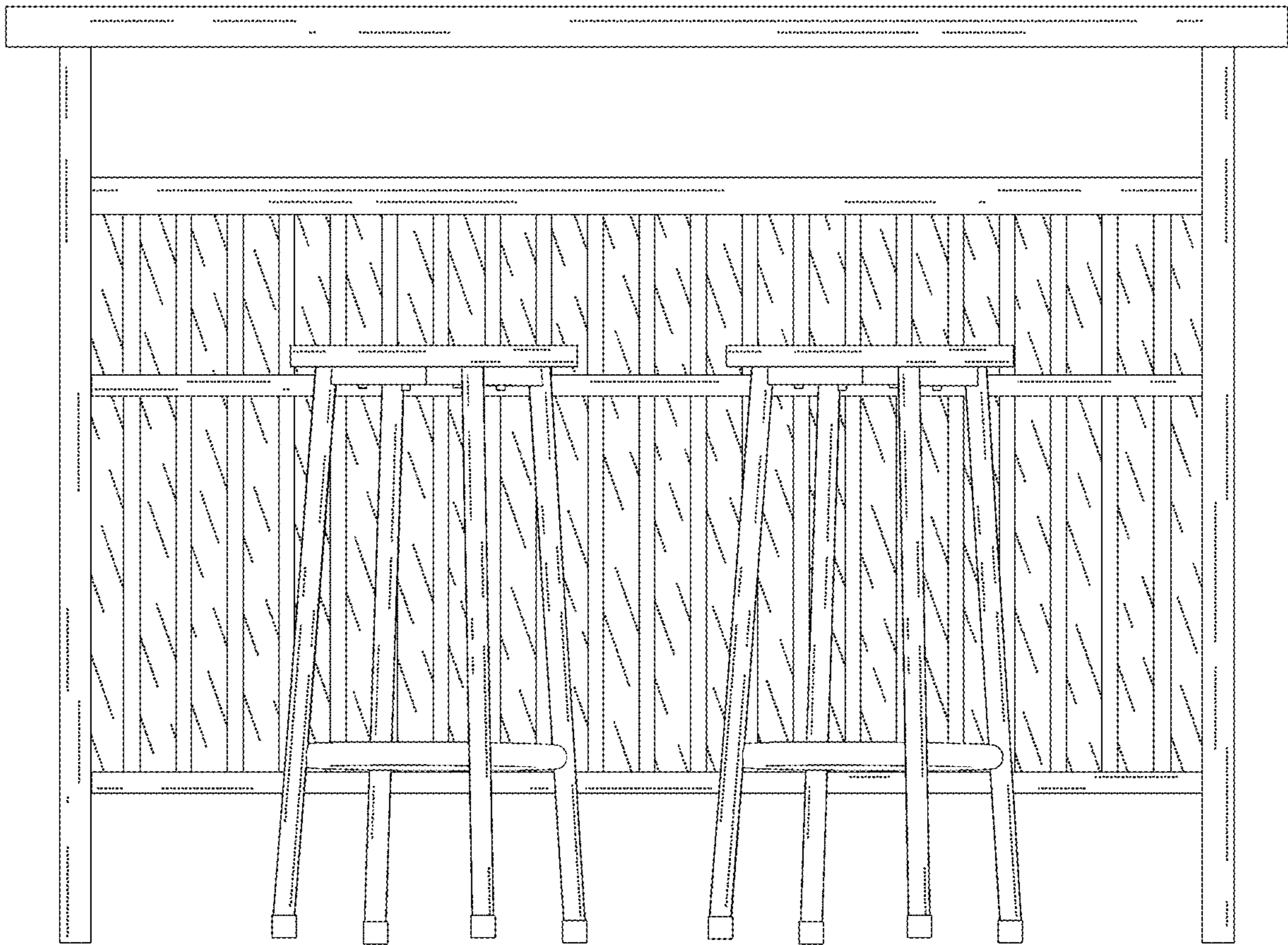

FIG. 2

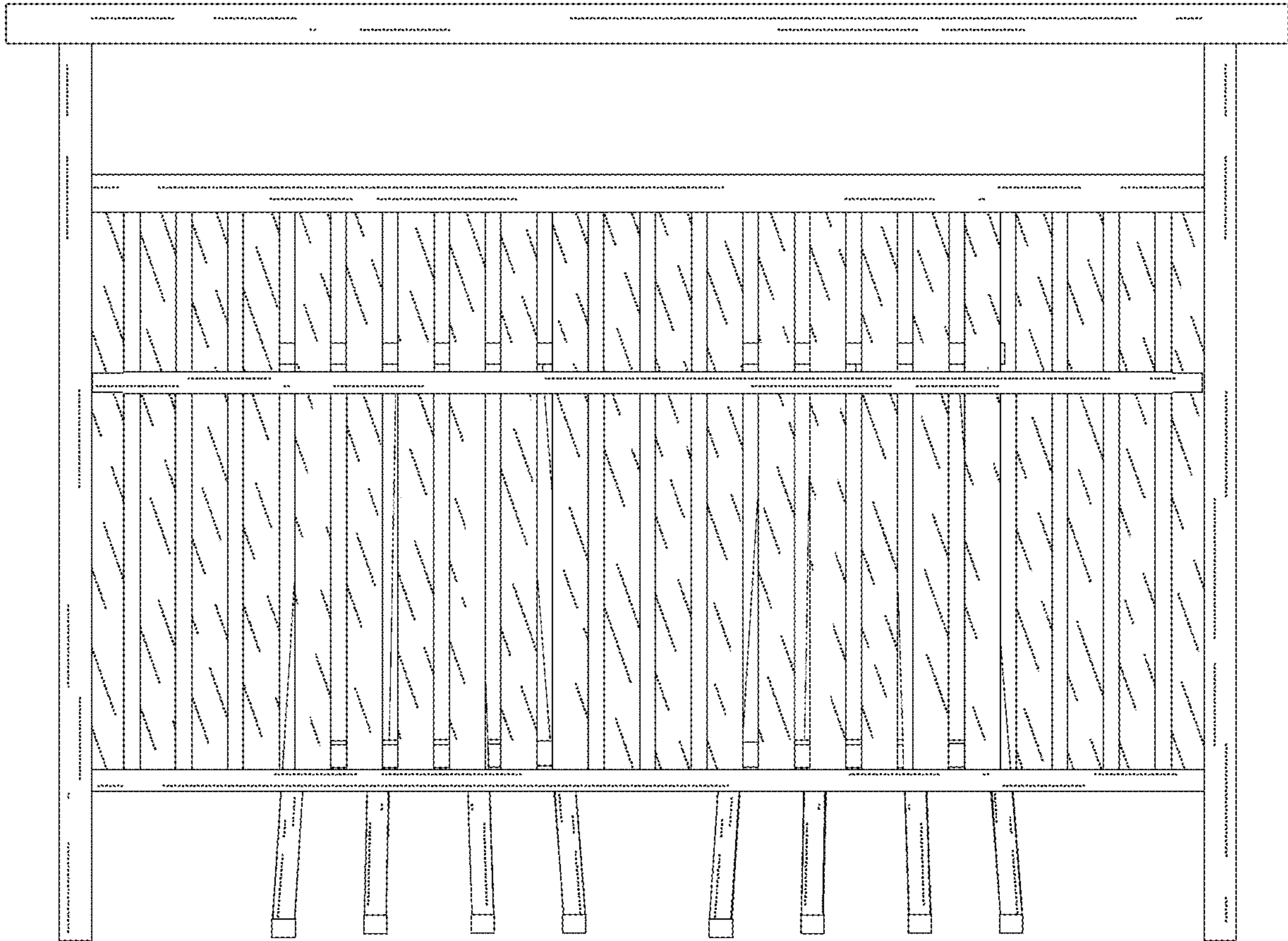

FIG. 3

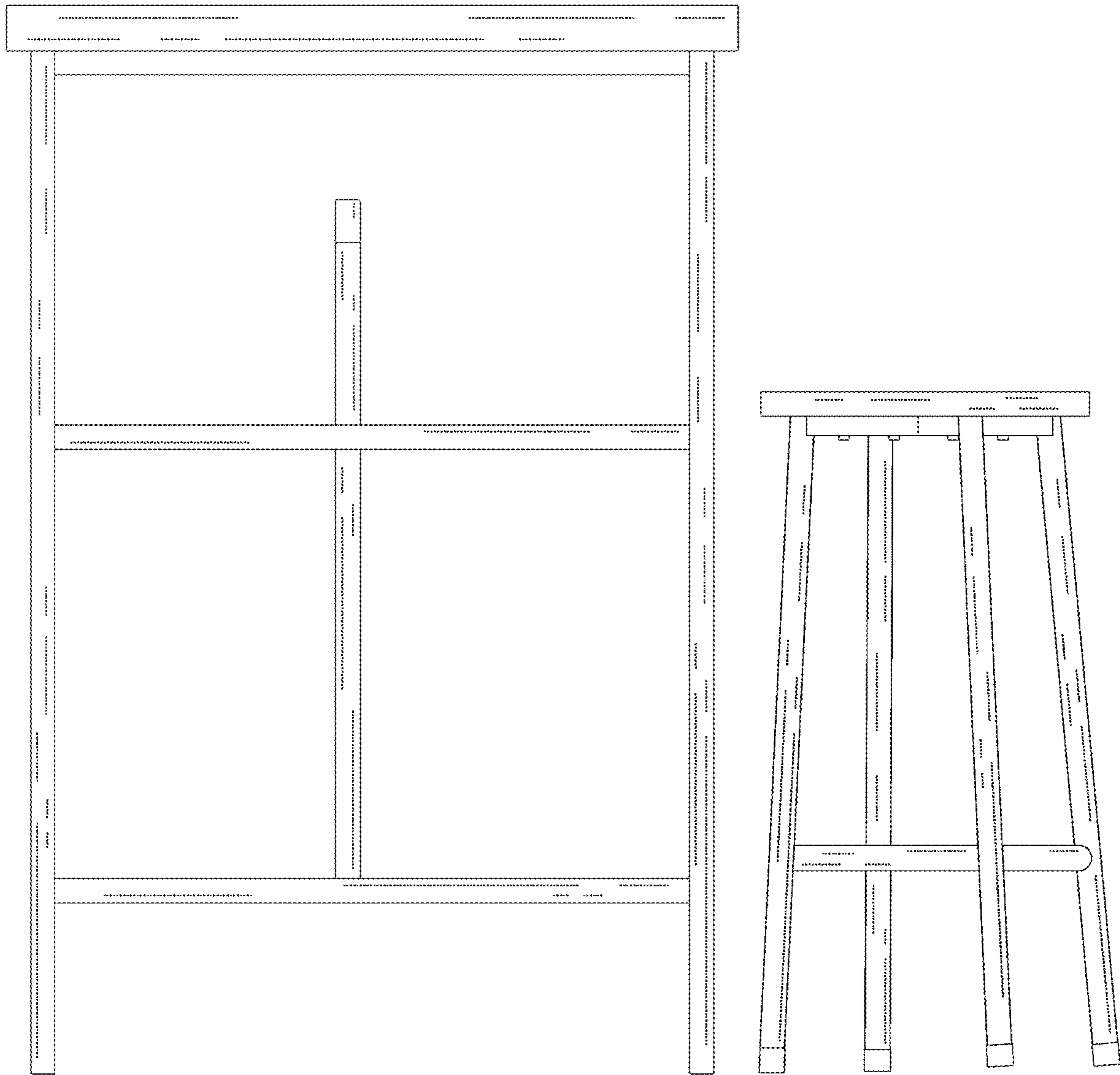

FIG. 4

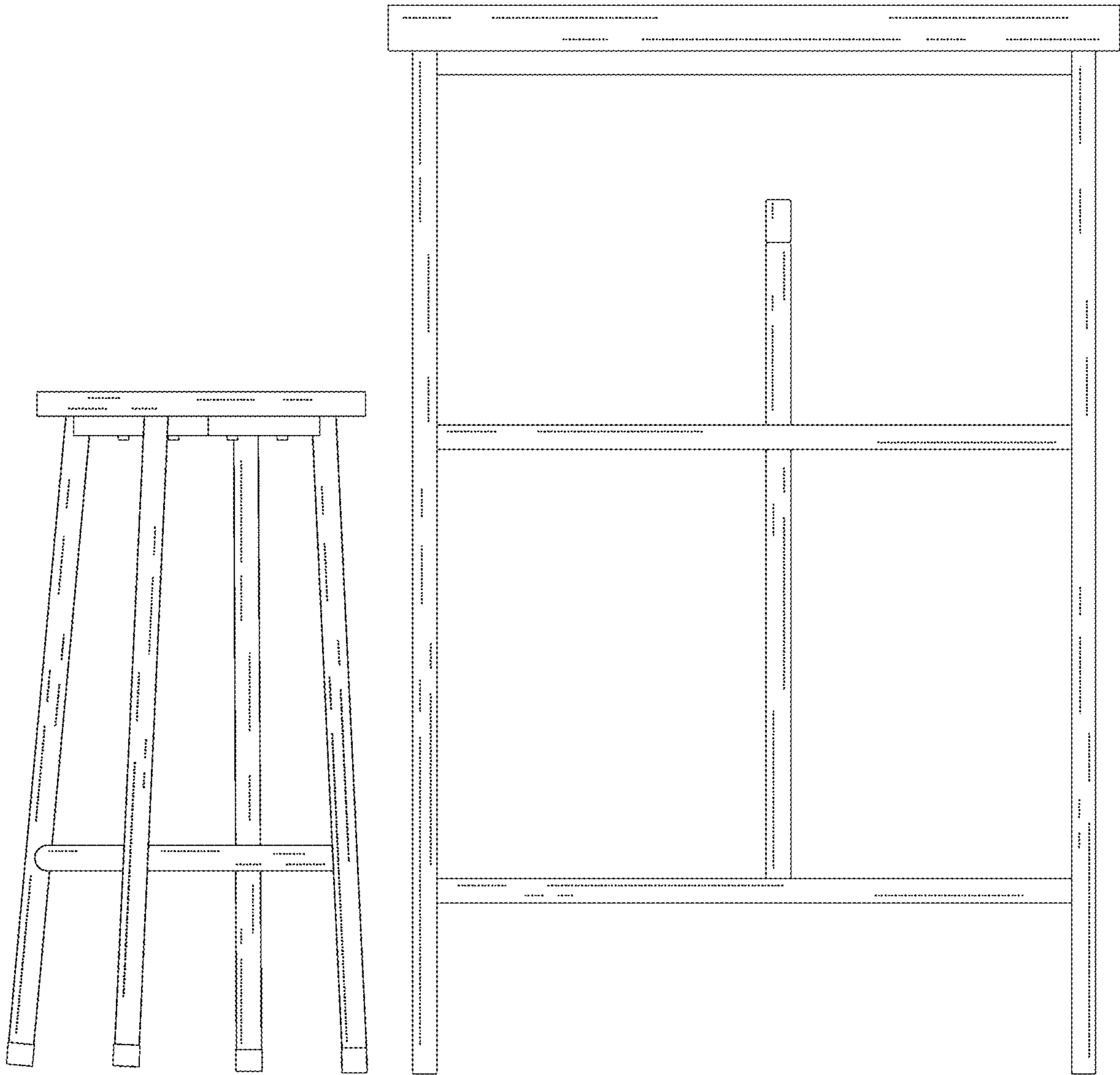

FIG. 5

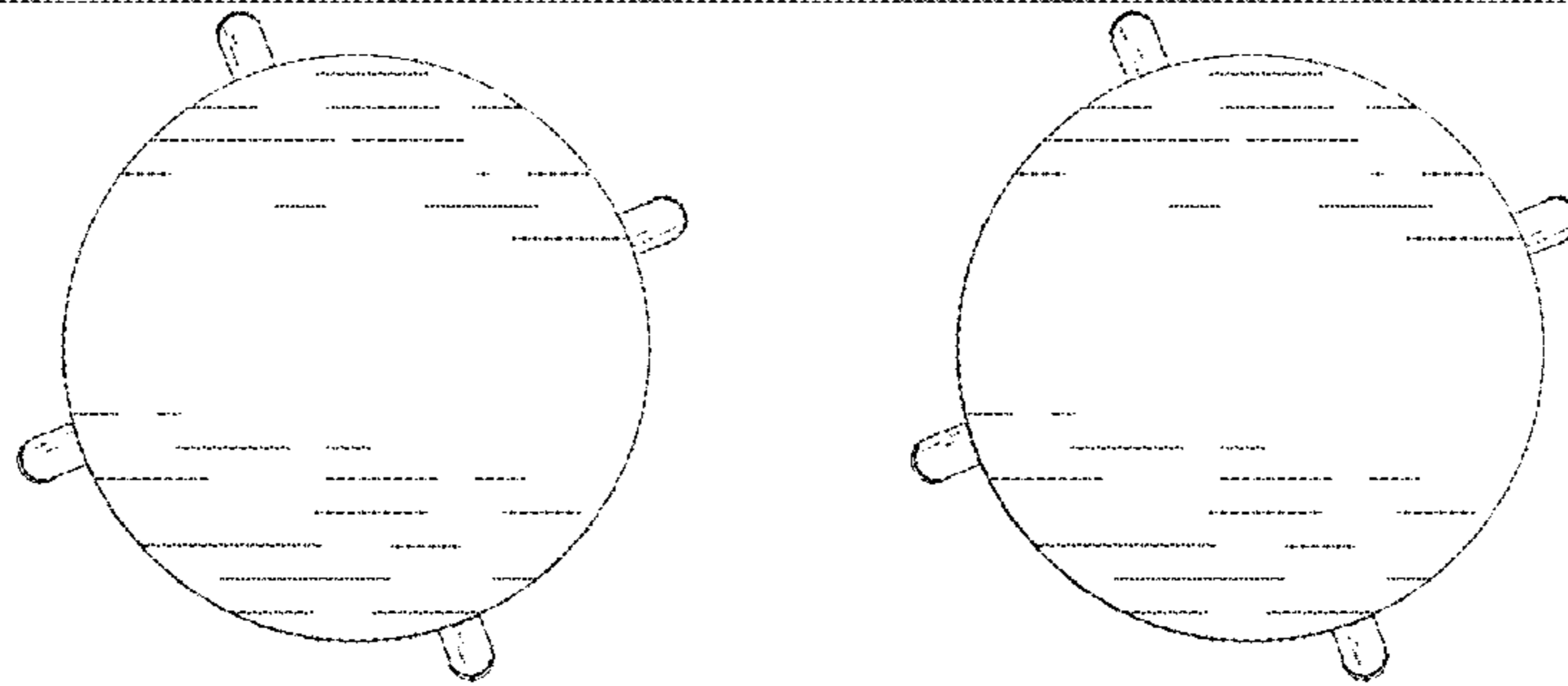
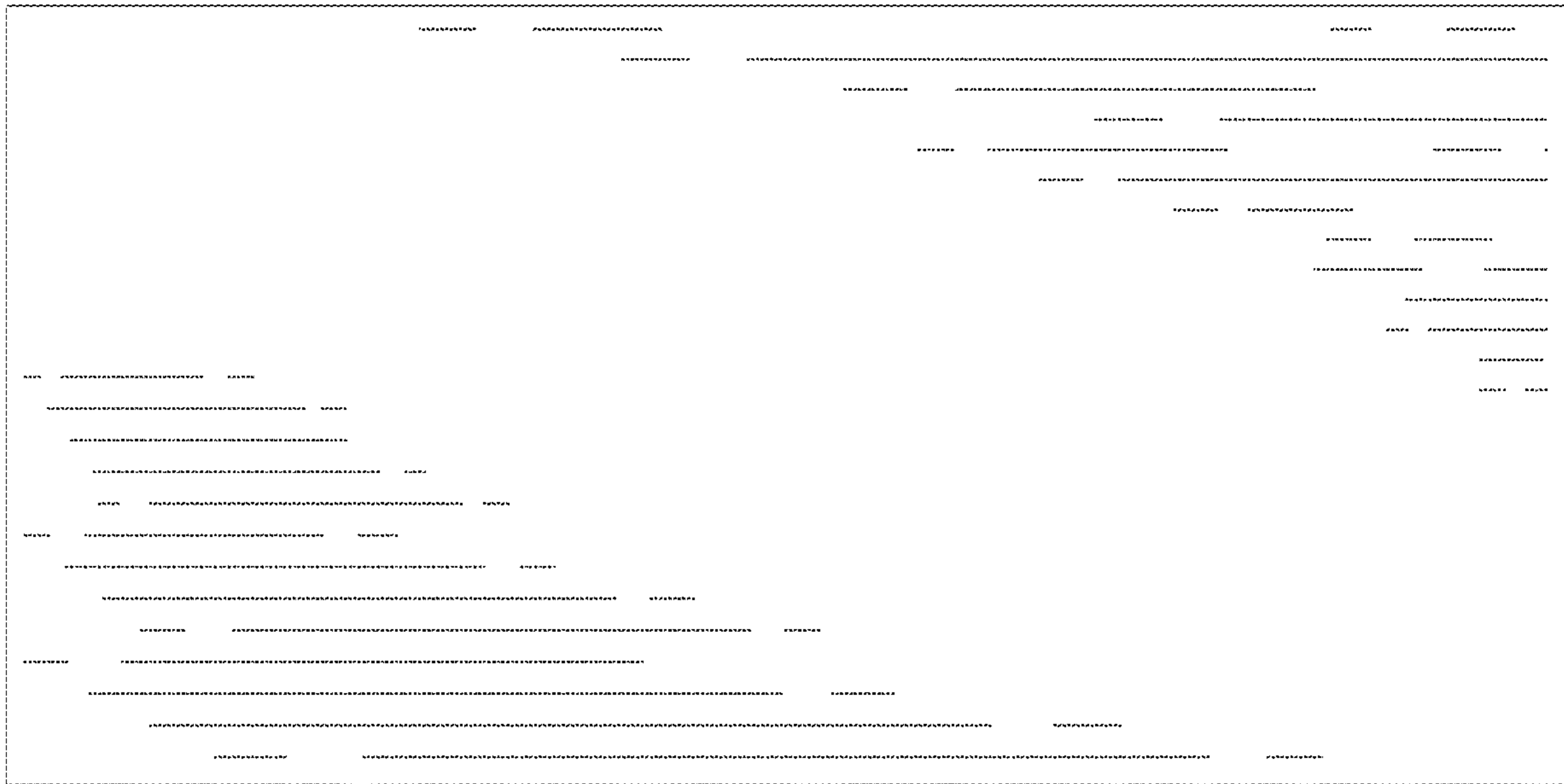

FIG. 6

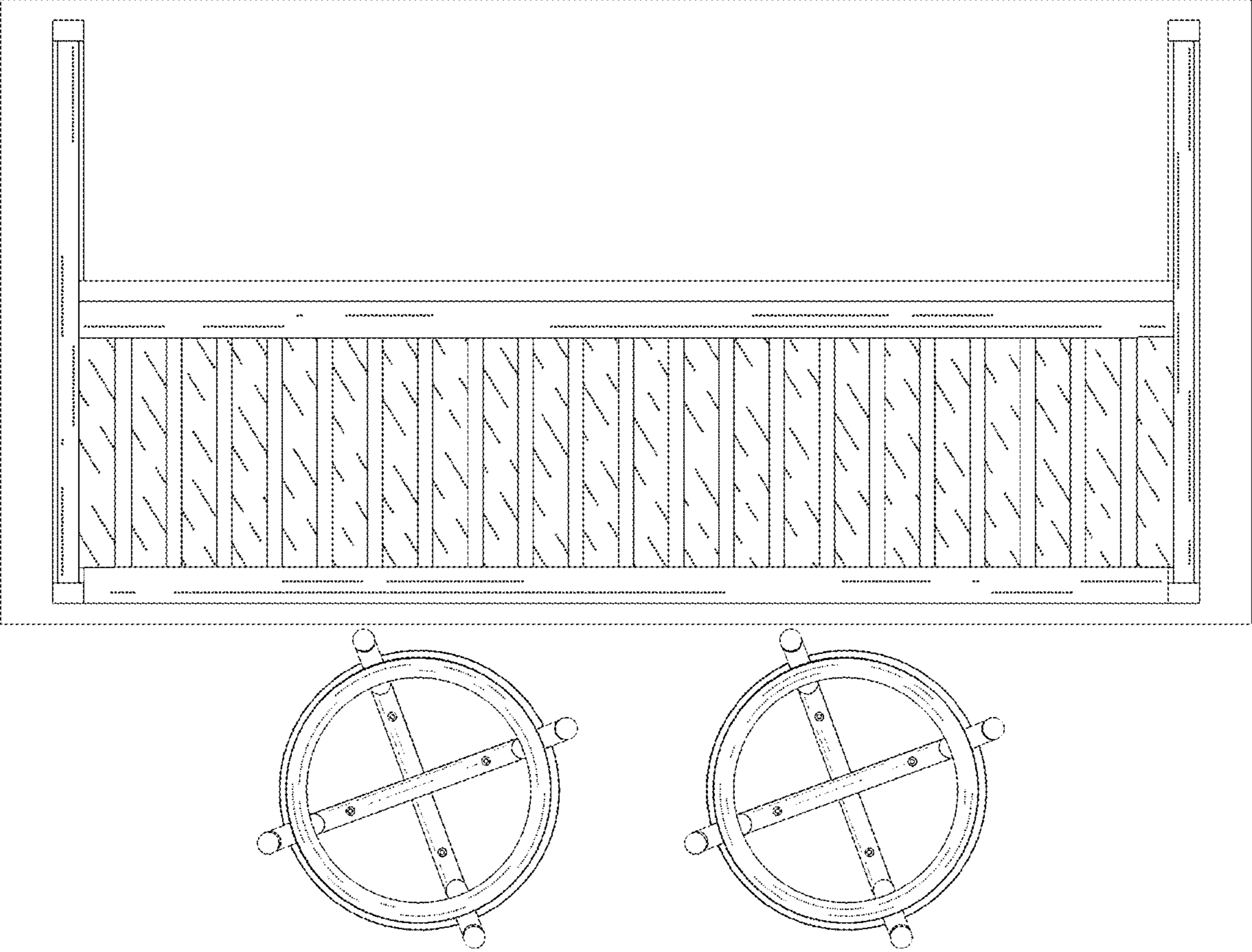

FIG. 7