

US00D967620S

(12) **United States Design Patent**
Gavrieli et al.

(10) **Patent No.:** **US D967,620 S**
(45) **Date of Patent:** **** Oct. 25, 2022**

(54) **SHOE WITH OUTSOLE PATCH**

- (71) Applicant: **Gavrieli Brands LLC**, Beverly Hills, CA (US)
- (72) Inventors: **Kfir Gavrieli**, Beverly Hills, CA (US);
Dikla Gavrieli, Beverly Hills, CA (US)
- (73) Assignee: **Gavrieli Brands LLC**, Beverly Hills, CA (US)
- (**) Term: **15 Years**
- (21) Appl. No.: **29/737,143**
- (22) Filed: **Jun. 5, 2020**

Related U.S. Application Data

- (63) Continuation of application No. 29/649,460, filed on May 30, 2018, now Pat. No. Des. 886,435, which is a continuation of application No. 29/570,429, filed on Jul. 7, 2016, now Pat. No. Des. 819,940, which is a continuation of application No. 29/509,208, filed on Nov. 14, 2014, now Pat. No. Des. 761,538, application No. 29/737,143, which is a continuation of application No. 15/905,239, filed on Feb. 26, 2018, now abandoned, which is a continuation of application No. 15/204,763, filed on Jul. 7, 2016, now Pat. No. 9,930,925, which is a continuation of application No. 14/266,599, filed on Apr. 30, 2014, now Pat. No. 9,398,786, which is a continuation of application No. 13/207,397, filed on Aug. 10, 2011, now Pat. No. 8,745,893.

- (51) **LOC (13) Cl.** **02-04**
- (52) **U.S. Cl.**
USPC **D2/971; D2/939**
- (58) **Field of Classification Search**
USPC ... D2/96, 990, 902, 904, 906-908, 916-924,
D2/925-945, 969, 970-979, 946-962;
36/1.5, 3 A, 83, 45, 99, 112-116, 1, 3 B,
36/22 R, 24.5, 28, 32 R, 34 R, 59 C,
36/67 A, 101-107, 117.3, 117.4, 124-136

CPC A43B 23/00; A43B 23/02; A43B 23/04;
A43B 23/07; A43B 23/024; A43B
23/0245; A43B 23/025; A43B 23/026;
A43B 23/265; A43B 23/14; A43B 23/16;
A43B 23/24; A43B 23/26; A43B 5/00;
A43B 5/001; A43B 5/002; A43B 5/003;
A43B 5/008; A43B 5/06; A43B 5/08;
A43B 5/10; A43B 5/12; A43B 5/14;
A43B 5/145; A43B 1/00; A43B 1/02;
A43B 1/04; A43B 1/0045; A43B 3/12;
A43B 7/00; A43B 9/00; A43B 9/08;
A43B 9/14; A43B 9/16; A43B 11/00;
A43B 21/00; A43B 21/02; A43B 21/04;
A43B 21/06; A43B 13/00; A43B 13/02;
A43B 13/023; A43B 13/026; A43B
13/04; A43B 13/08; A43B 13/10; A43B
13/12; A43B 13/14; A43B 13/141; A43B
13/143; A43B 13/16; A43B 13/18; A43B
13/181; A43B 13/187; A43B 13/189;
A43B 13/20; A43B 13/22; A43B 13/223;
A43B 13/24; A43B 13/28; A43B 13/30;
A43B 13/32; A43B 13/34; A43B 13/36;
A43C 1/00; A43C 1/003; A43C 1/06;
A43C 3/00; A43C 5/00; A43C 7/00;
A43C 11/00

See application file for complete search history.

(56)

References Cited

U.S. PATENT DOCUMENTS

249,086 A	11/1881	Pienovi
773,850 A	11/1904	Cooper et al.
830,941 A	9/1906	Walden
1,208,209 A	12/1916	Prince
1,214,666 A	2/1917	Ford
1,519,009 A	12/1924	Reina
1,525,848 A	2/1925	Bonaventure
1,587,377 A	6/1926	Grosjean
1,650,466 A	11/1927	Righter
2,224,590 A	12/1940	Boivin
2,268,777 A	1/1942	Scholl
D133,819 S	9/1942	Harris
D135,791 S	6/1943	Beebe
2,323,563 A	7/1943	Nugent
2,342,882 A	2/1944	Meltzer
D141,871 S	7/1945	Braun

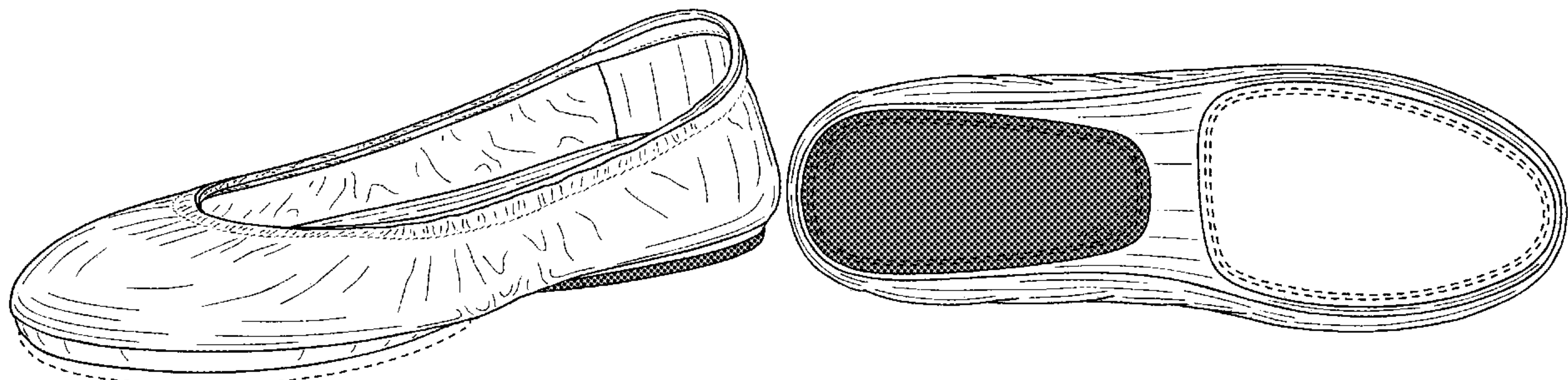

US D967,620 S

2,383,585 A	8/1945	Bindner	8,020,320 B2	9/2011	Gillespie
D149,685 S	5/1948	Sandler	8,127,468 B2	3/2012	Morgan
D150,729 S	8/1948	Sandler	D657,543 S	4/2012	Bove
D166,090 S	3/1952	Maling	D659,960 S	5/2012	Bizzo
2,772,488 A	12/1956	Meltzer	8,230,619 B2	7/2012	Salvatelli
2,904,814 A	9/1959	Scholl	D664,755 S	8/2012	Gavrieli et al.
3,148,378 A	9/1964	Tibbitts	D665,157 S	8/2012	Wu
D200,897 S	4/1965	Mitchell	8,240,067 B2	8/2012	Sussmann
D220,464 S	4/1971	Hayoshi	8,245,420 B2	8/2012	Wilson
D247,396 S	3/1978	Schlerth	D668,027 S	10/2012	Millieret
4,412,393 A	11/1983	Terlizzi, Jr. et al.	D668,438 S	10/2012	Millieret
D275,525 S	9/1984	Nakao	D668,847 S	10/2012	Gavrieli et al.
4,674,206 A	6/1987	Lyden	D668,848 S	10/2012	Gavrieli et al.
D295,692 S	5/1988	Zuidema et al.	D668,849 S	10/2012	Pozzi
D300,085 S	3/1989	Ito et al.	D668,850 S	10/2012	Pozzi
RE33,018 E	8/1989	Ostrander	D672,542 S	12/2012	Gray et al.
4,899,412 A	2/1990	Ganon	D672,550 S	12/2012	Gavrieli
D316,773 S	5/1991	Valle	D672,552 S	12/2012	Gavrieli
5,012,541 A	5/1991	Ganon	D676,634 S	2/2013	Gavrieli et al.
D339,669 S	9/1993	Miller	D680,007 S	4/2013	Gavrieli
5,282,326 A	2/1994	Schroer, Jr. et al.	D681,927 S	5/2013	Gavrieli
5,421,050 A	6/1995	Laganas	D681,928 S	5/2013	Gavrieli
5,699,629 A	12/1997	Munschy	D681,929 S	5/2013	Gavrieli
5,746,014 A	5/1998	Tanemoto	D683,936 S	6/2013	Gavrieli
D420,785 S	2/2000	Perez	8,468,723 B2	6/2013	Malka-Harari
6,055,745 A	5/2000	Endoh	D686,812 S	7/2013	Gavrieli et al.
6,076,284 A	6/2000	Terlizzi	8,510,975 B2	8/2013	Krikelis
6,189,239 B1	2/2001	Gasparovic et al.	D688,853 S	9/2013	Gavrieli
6,338,207 B1	1/2002	Chang	D688,854 S	9/2013	Gavrieli
D457,292 S	5/2002	Sessa	D688,855 S	9/2013	Gavrieli
D461,947 S	8/2002	Merceron	D689,270 S	9/2013	Gavrieli
6,588,124 B2	6/2003	Morrone	D689,271 S	9/2013	Gavrieli
D476,798 S	7/2003	Reynolds et al.	D689,272 S	9/2013	Gavrieli
D498,041 S	11/2004	McClaskie	D690,914 S	10/2013	Gavrieli
D500,191 S	12/2004	Belley et al.	D690,915 S	10/2013	Gavrieli
D501,706 S	2/2005	McClaskie	D696,500 S	12/2013	Hunt
6,857,203 B2	2/2005	Minden	D699,424 S	2/2014	Hamm
6,895,693 B2	5/2005	Baruck	8,661,714 B2	3/2014	Sussman
6,978,557 B2	12/2005	Lee	D703,531 S	4/2014	Gavrieli et al.
7,032,327 B1	4/2006	Tartaglia et al.	8,745,893 B2	6/2014	Gavrieli et al.
7,036,244 B1	5/2006	Finch	8,973,287 B2	3/2015	Shibata
D527,513 S	9/2006	Della Valle	D747,595 S	1/2016	Gavrieli
D529,513 S	10/2006	Aketa	D749,829 S	2/2016	Gavrieli
D531,790 S	11/2006	Wurzburg	D749,830 S	2/2016	Gavrieli
D534,341 S	1/2007	Choi	D750,360 S	3/2016	Gavrieli
D542,513 S	5/2007	Amado et al.	D750,361 S	3/2016	Gavrieli
D556,990 S	12/2007	Cabados	D750,872 S	3/2016	Gavrieli
7,337,558 B2	3/2008	Terlizzi et al.	D750,873 S	3/2016	Gavrieli
D567,485 S	4/2008	James	D750,874 S	3/2016	Gavrieli
D570,488 S	6/2008	Kirksey et al.	D751,279 S	3/2016	Gavrieli
D571,084 S	6/2008	Comeau	D751,280 S *	3/2016	Vasquez D2/939
D571,548 S	6/2008	Seamans	D751,872 S	3/2016	Gavrieli
D571,989 S	7/2008	Siegal	D755,485 S	5/2016	Gavrieli
D580,640 S	11/2008	Wurzburg	D755,486 S	5/2016	Gavrieli
D582,638 S	12/2008	Ringholz	D755,487 S	5/2016	Gavrieli
7,496,982 B2	3/2009	Clark et al.	D755,488 S	5/2016	Gavrieli
7,506,459 B2	3/2009	Grisoni et al.	D756,081 S	5/2016	Gavrieli
D591,031 S	4/2009	Cofinco	D756,082 S	5/2016	Gavrieli
D593,295 S	6/2009	Belley et al.	D756,083 S	5/2016	Gavrieli
D593,297 S	6/2009	Belley et al.	D756,084 S	5/2016	Gavrieli
D593,307 S	6/2009	Belley et al.	D756,087 S	5/2016	Gavrieli
D599,093 S	9/2009	Issler	D757,407 S	5/2016	Gavrieli
D604,030 S	11/2009	Wilson	D758,052 S	6/2016	Gavrieli
D607,194 S	1/2010	Zagula	D758,053 S	6/2016	Gavrieli
D610,332 S	2/2010	Raichle	D761,529 S	7/2016	Gavrieli
D610,785 S	3/2010	Smith	D761,530 S	7/2016	Gavrieli
D612,140 S	3/2010	Moon	D761,531 S	7/2016	Gavrieli
D612,141 S	3/2010	Moon	D761,532 S	7/2016	Gavrieli
7,694,435 B1	4/2010	Kiser et al.	D761,533 S	7/2016	Gavrieli
D615,737 S	5/2010	Feller	D761,534 S	7/2016	Gavrieli
7,735,244 B1	6/2010	Ameche	D761,535 S	7/2016	Gavrieli
7,743,530 B2	6/2010	Truelsen	D761,536 S	7/2016	Gavrieli
D618,891 S	7/2010	McClaskie	D761,537 S	7/2016	Gavrieli
7,757,408 B2	7/2010	McClaskie	D761,538 S	7/2016	Gavrieli
D630,829 S	1/2011	Weisner	D761,539 S	7/2016	Gavrieli
D632,881 S	2/2011	Rosenberg	D762,050 S	7/2016	Gavrieli
7,926,203 B2	4/2011	Wilkenfeld	9,398,786 B2	7/2016	Gavrieli et al.
7,966,747 B2	6/2011	Wilkenfeld et al.	D763,556 S	8/2016	Gavrieli
D640,861 S	7/2011	Wilkenfeld	D763,557 S	8/2016	Gavrieli

US D967,620 S

D764,154 S	8/2016	Gavrieli		D901,859 S *	11/2020	Gavrieli	A43B 3/108
D771,919 S	11/2016	Gavrieli						D2/950
D771,920 S	11/2016	Gavrieli		D901,860 S *	11/2020	Gavrieli	D2/950
D775,798 S	1/2017	Gavrieli		D901,861 S *	11/2020	Gavrieli	D2/950
D779,798 S	2/2017	Gavrieli		D901,862 S *	11/2020	Gavrieli	D2/950
D779,799 S	2/2017	Gavrieli		D901,863 S *	11/2020	Gavrieli	D2/971
D779,800 S	2/2017	Gavrieli		D901,871 S *	11/2020	Gavrieli	D2/971
D779,801 S	2/2017	Gavrieli		D902,544 S *	11/2020	Gavrieli	A43B 3/248
D781,032 S	3/2017	Gavrieli						D2/950
D781,033 S	3/2017	Gavrieli		D903,279 S *	12/2020	Gavrieli	A43B 3/24
D781,034 S	3/2017	Gavrieli						D2/971
D781,035 S	3/2017	Gavrieli		D903,988 S *	12/2020	Gavrieli	D2/939
D782,167 S	3/2017	Gavrieli		D903,989 S *	12/2020	Gavrieli	D2/939
D790,336 S	6/2017	Gavrieli		D943,252 S *	2/2022	Gavrieli	D2/939
D805,277 S	12/2017	Gavrieli		D943,876 S *	2/2022	Gavrieli	D2/939
D812,867 S	3/2018	Gavrieli		D943,897 S *	2/2022	Gavrieli	A43B 3/108
D812,868 S	3/2018	Gavrieli						D2/947
D814,153 S	4/2018	Gavrieli		D945,128 S *	3/2022	Gavrieli	D2/939
D814,769 S *	4/2018	McClaskie D2/971	D945,751 S *	3/2022	Gavrieli	A43B 13/122
9,930,925 B2	4/2018	Gavrieli et al.						D2/939
D818,684 S	5/2018	Gavrieli		2002/0078591 A1	6/2002	Morrone		
D818,692 S	5/2018	Gavrieli		2002/0129519 A1	9/2002	Cahan		
D819,313 S	6/2018	Gavrieli		2003/0070319 A1	4/2003	Minden		
D819,321 S	6/2018	Gavrieli		2003/0121176 A1	7/2003	Baruck		
D819,940 S	6/2018	Gavrieli		2004/0025377 A1	2/2004	Brannon		
D824,148 S	7/2018	Gavrieli		2005/0022421 A1	2/2005	Bruckner		
D824,149 S	7/2018	Gavrieli		2005/0115115 A1	6/2005	Lacey		
D824,150 S	7/2018	Gavrieli		2005/0217148 A1	10/2005	Connolly et al.		
D824,655 S	8/2018	Gavrieli		2005/0262734 A1	12/2005	Cheng		
D824,656 S	8/2018	Gavrieli		2006/0086005 A1	4/2006	Yerian		
D825,155 S	8/2018	Gavrieli		2006/0156576 A1	7/2006	Sloan		
D825,156 S	8/2018	Gavrieli		2007/0074424 A1	4/2007	Lin		
D825,160 S	8/2018	Gavrieli		2007/0204482 A1	9/2007	Gibson-Collinson		
D826,524 S	8/2018	Gavrieli		2007/0204483 A1	9/2007	Kirsch et al.		
D831,312 S	10/2018	Gavrieli		2008/0052964 A1	3/2008	Taylor		
D831,313 S *	10/2018	Hawthornthwaite D2/939	2008/0086912 A1	4/2008	Wilkenfeld		
D833,729 S *	11/2018	Hawthornthwaite D2/971	2008/0110059 A1	5/2008	Kuramoto et al.		
D837,495 S	1/2019	Gavrieli		2009/0019732 A1	1/2009	Sussmann		
D842,593 S	3/2019	Gavrieli		2009/0193685 A1	8/2009	Wilson		
D843,092 S	3/2019	Gavrieli		2009/0205222 A1	8/2009	Mclinden		
D843,093 S	3/2019	Gavrieli		2009/0272009 A1	11/2009	Weisner et al.		
D843,094 S	3/2019	Gavrieli		2010/0011625 A1	1/2010	Percival		
D844,305 S	4/2019	Gavrieli		2010/0018080 A1	1/2010	Smith		
D844,312 S	4/2019	Gavrieli		2010/0050469 A1	3/2010	Chen		
D844,313 S *	4/2019	Hawthornwaite D2/971	2010/0095557 A1	4/2010	Jarvis		
D844,950 S	4/2019	Gavrieli		2010/0115793 A1	5/2010	Kraisosky		
D844,951 S	4/2019	Gavrieli		2010/0122475 A1	5/2010	Purrington		
D846,240 S	4/2019	Gavrieli		2010/0146822 A1	6/2010	MacGregor		
D846,246 S	4/2019	Gavrieli		2010/0212186 A1	8/2010	Cheng		
D846,258 S	4/2019	Gavrieli		2010/0275462 A1	11/2010	Pucci		
D846,259 S	4/2019	Gavrieli		2010/0281713 A1	11/2010	Pantazes		
D846,844 S	4/2019	Gavrieli		2013/0036630 A1 *	2/2013	Gavrieli	A43B 3/12
D846,845 S	4/2019	Gavrieli						36/102
D846,846 S	4/2019	Gavrieli		2013/0039605 A1 *	2/2013	Gavrieli	A45C 3/12
D846,847 S	4/2019	Gavrieli						383/37
D846,848 S	4/2019	Gavrieli		2015/0089843 A1	4/2015	Gavrieli		
D846,849 S	4/2019	Gavrieli		2021/0137210 A1 *	5/2021	Gavrieli	A43B 13/14
D846,860 S	4/2019	Gavrieli						
D847,474 S	5/2019	Gavrieli						
D847,476 S	5/2019	Gavrieli						
D851,872 S *	6/2019	Gavrieli D2/939					
D853,091 S *	7/2019	Gavrieli D2/939					
D853,092 S *	7/2019	Gavrieli D2/939					
D853,697 S *	7/2019	Gavrieli D2/939					
D853,698 S *	7/2019	Gavrieli D2/939					
D859,792 S *	9/2019	Subatella Sanchez D2/902					
D872,987 S *	1/2020	Hawthornthwaite D2/971					
D884,323 S *	5/2020	Gavrieli D2/951					
D885,018 S *	5/2020	Gavrieli D2/939					
D889,081 S *	7/2020	Gavrieli D2/939					
D889,785 S *	7/2020	Gavrieli D2/939					
D890,483 S *	7/2020	Gavrieli D2/939					
D891,045 S *	7/2020	Swierszczyk D2/923					
D891,047 S *	7/2020	Gavrieli D2/939					
D891,073 S *	7/2020	Barerra D2/971					
D895,237 S *	9/2020	Swierszczyk D2/939					
D895,255 S *	9/2020	Swierszczyk D2/971					
D901,148 S *	11/2020	Gavrieli D2/950					
D901,858 S *	11/2020	Gavrieli D2/950					

FOREIGN PATENT DOCUMENTS

DE	20 2006 000230 U1	5/2007
GB	2443937 A	5/2008
GB	2 446 205 A	8/2008
TW	D119165	10/2007

OTHER PUBLICATIONS

Letter from TMI and Associates with Office Action, 2 pgs, dated Sep. 19, 2012 <http://www.payless.com/store/?&TLC=Womens&SLC=WomensNewArrivals&BLC=WomensNewArrivalsNewArrivals&With+Regular&ItemCode=60131&LotNumber=062642&Type=Adult&Popularity=637&Descriptvein>.

Taiwanese Office Action for TW 101300726, 10 pgs., dated Sep. 6, 2012.

“The Love List, Ties by Gavrieli—Foldable Ballet Flats,” <http://thelovelist-carly.blogspot.com.au/2010/09/ties-by-gavrieli-foldable-ballet.html>, 2 pgs., Sep. 12, 2020.

- “Tieks by Gavrieli,” <http://tieks.com>, 1 pg., retrieved Mar. 13, 2013 from URL.
- “Try It Mummy!, Tieks by Gavrieli,” <http://tryitmummy.blogspot.com.au/2010/12/tieks-by-gavrieli.html>, 3 pgs., Dec. 9, 2010.
- “Wearability—Real People Style, What came first, the City Flat or the Tieks,” <http://wearability.posterous.com/what-came-first-the-city-flat-or-the-tieks>, 2 pgs., Aug. 29, 2010.
- “The Ballet Flat . . . Reinvented; Ballet Flats . . . with a Bonus; Step Into Tieks; Going Places? Take Tieks,” <http://web.archive.org/web/2010052004346/http://www.tieks.com/>; 4 pgs., May 24, 2010.
- “Tieks—Comfortable designer flats you can fit in your purse and wear all day, every day,” <http://web.archive.org/web/20110731151555/http://tieks.com/>; 6 pgs., Jul. 31, 2011.
- “58th Annual Emmy Awards,” http://spoonsforksandfashion.blogspot.com/2006_08_01_archive.html, depicting Nine West flats, 2 pgs., Aug. 1, 2006.
- Pictures of Nine West flats sold in 2006, 3 pgs.
- “I Love a Good Ballet Flat!,” <http://dressupfiles.com/i-love-a-good-ballet-flat>, depicting Sue London flats, 3 pgs., Sep. 3, 2010.
- Pictures of Sue London flats sold in 2010, 2 pgs.
- “Miss Cathie Reviews: The Yosi Samra Foldable Ballet Flat . . .,” <http://www.misscathie.com/2010/01/miss-cathie-reviews-the-yosi-samra-foldable-ballet-flat/>, depicting Yosi Samra flats, 9 pgs., Jan. 2010.
- Pictures of Yosi Samra flats sold in 2010, 2 pgs.
- “Goodbye two thousand ten,” http://emmajoyrussell.blogspot.com/2010_12_01_archive.html, depicting Gap flats, 39 pgs., Dec. 1, 2010.
- Pictures of Gap flats available for sale in 2010, 9 pgs.
- “Our newest design of folding flats-Pink,” <https://fitinclouds.wordpress.com/2010/05/16/our-newest-design-of-folding-flats-pink/>, depicting Fit in Clouds flats, 1 pg., May 16, 2010.
- “Fit in Clouds Satin Folding Shoes,” <http://www.goodhousekeeping.com/product-reviews/clothing/best-ballet-flats/fit-in-clouds-satin-foldable-ballet-flats>, depicting Fit in Clouds flats, 2 pg., Aug. 2013.
- Pictures of Fit in Clouds flats available for sale in 2011, 4 pgs.
- “Shoes for Standing,” <https://truthinshoes.wordpress.com/2008/07/>, depicting Sam & Libby flats, 2 pgs., Jul. 31, 2008.
- “Target Designer Collaboration: Announcing Sam & Libby Shoes for Target,” <http://www.therecessionista.com/2012/11/target-designer-collaboration-announcing-sam-libby-shoes-for-target.html>, depicting Sam & Libby flats, 1 pg., Nov. 26, 2012.
- Pictures of Sam & Libby flats available for purchase in 2011, 5 pgs.
- “Save your soles with Citisoles ballet flats,” <http://glamazondiaries.com/2009/07/save-your-soles-with-citisoles-ballet-flats>, depicting Citisoles flats, 3 pgs., Jul. 2009.
- Pictures of Citisoles flats available for purchase in 2009, 3 pgs.
- “#16 Corso Como Delicious Pumps Review and Giveaway!,” <http://www.mommatoldmeblog.com/2011/01/16-corso-como-delicious-pumps-review.html>, depicting Corso Como flats, 8 pgs., Jan. 16, 2011.
- Pictures of Corso Como flats available for sale in 2011, 3 pgs.
- “Jil-sander-navy-lead-ballet-flats-product . . .,” www.ebay.com, depicting Jil Sander flats, 4 pgs., Nov. 2013.
- Pictures of Jil Sander flats available for sale in 2011, 3 pgs.
- “Spare Soles: Shoes That Roll-up & Fold-up,” <http://herpackinglist.com/2011/01/spare-soles-shoes/>, depicting Spare Soles flats, 2 pgs., Jan. 2011.
- Pictures of Spare Soles flats available for sale in 2011, 5 pgs.
- Pictures of Roll-Upz by Spare Soles flats available for sale in 2011, 6 pgs.
- “The Cutest Blog, Preppy 50 and Loving Lilly, Ballet Flat Delight,” <http://preppy50andlovinglilly.blogspot.com/2011/02/ballet-flat-delight.html>, depicting Henri Bendel flats, 1 pg., Feb. 19, 2011.
- Pictures of Henri Bendel flats available for sale in 2011, 4 pgs.
- “Mumsnet by parents for parents,” http://www.mumsnet.com/Talk/style_and_beauty/a1612000-Anyone-tried-Redfoot-Flatmates-foldable-ballet-pumps, depicting Redfoot Flatmates flats, 1 pg, Nov. 14, 2012.
- Pictures of Redfoot Flatmates flats available for sale in 2011, 6 pgs.
- “Amazon.com: Customer Reviews: Bloch London Women’s Lux Ballet Flat,” <http://www.amazon.com/Bloch-London-Womens-Ballet-Flat/product-reviews/B004LWP7YW>, depicting Bloch London flats, 4 pgs., Dec. 11, 2011.
- Pictures of Bloch London flats offered for sale in 2011, 11 pgs.
- “H&m foldable leopard print flat,” <https://8485shops.wordpress.com/2011/06/16/flats-for-7-bucks/shoe1/>, depicting h&m flats, 2 pgs., Jun. 16, 2011.
- Pictures of h&m foldable flats offered for sale in 2011, 4 pgs.
- “Seekyt—Juicy Couture Ballet Flats—Are They Worth The Money?,” <http://seekyt.com/juicy-couture-ballet-flats-are-they-worth-the-money/>, 2 pgs., Jun. 3, 2011.
- Pictures of Juicy Couture flats offered for sale in 2011, 3 pgs.
- “Purse Flats,” <http://purseflats.wordpress.com>, depicting Purse Flats by Erica Wilson, 3 pgs., Jul. 12, 2012.
- Pictures of Purse Flats by Erica Wilson offered for sale in 2011, 6 pgs.
- “Tieks by Gavrieli—Comfortable, designer flats you can fit in your purse and wear all day . . .,” <http://web.archive.org/web/20110202210649/http://www.tieks.com/>, 8 pgs., Feb. 2, 2011.
- “Carolina M. M. Goncalves > Tieks by Gavrieli,” http://m2.facebook.com/Tieks?v=timeline&filter=2&timecutoff=1406427986&page=17§ionLoadingID=m_timeline_loading_div_1293868799_1262332800_8_17&timeend=1293868799×tart=1262332800&tm=AQDOvqhWQPN_Nbwm&refid=17, 1 pg. Jan. 26, 2010.
- “The Shoes Oprah Would Wear to Work (if She Had to Walk),” <http://www.inc.com/30under30/christina-desmarais/kfir-gavrieli-and-elram-gavrieli-founders-of-tieks.html>, 2 pgs., Jul. 2, 2012.
- “Tieks by Gavrieli,” http://m2.facebook.com/Tieks?v=timeline&filter=2&timecutoff=1406427986&page=14§ionLoadingID=m_timeline_loading_div_1293868799_1262332800_8_14&timeend=1293868799×tart=1262332800&tm=AQDOvqhWQPN_Nbwm&refid=17, 4 pgs., Jan. 26, 2010.
- “Mighty Life List, Sensible Shoes,” <http://mightygirl.com/2010/08/24/sensible-shoes/>, 11 pgs., Aug. 24, 2010.
- “Find! Tieks: Fab & sexy flats for fall,” <http://thefabmom.com/2013/08/29/find-tieks-fab-sexy-flats-for-fall/>, 3 pgs. Aug. 29, 2013.
- “Step into Tieks,” <http://sliceofpink.typepad.com/blog/2010/09/tieks-1.html>, 5 pgs., Sep. 22, 2010.
- “In Need of Flat-Soled Shoes,” <http://www.kellywickham.com/mochamomma/2010/10/4/in-need-of-flat-soled-shoes.html>, 4 pgs., Oct. 3, 2010.
- “Say Hello to the Flat Shoes You Need for Fall . . . All 88 of Them!”, Picture of Adam Tucker Shoe/Slipper, <https://www.facebook.com/search/top/?q=adam%20shoes%20slipper>, last accessed Oct. 28, 2016, dated Oct. 1, 2013, 1 page.
- Picture of Adam Tucker Rainbow Shoes, <https://www.facebook.com/search/top/?q=adam%20shoes%20rainbow>, last accessed Oct. 28, 2016, dated Aug. 14, 2013, 1 page.
- Third Party Submission Under 37 CFR 1.290 regarding U.S. Appl. No. 15/905,239, filed Feb. 9, 2019, 94 pages.
- Order Granting TRO (D.I. 11), *Gavrieli Brands LLC vs. Soto Massini*, Civil Action No. 1:18-cv-00462, Mar. 28, 2018, 2 pages.
- Defendants’ Opposition To Motion For Temporary Restraining Order, Civil Action No. 1:18-cv-00462-GMS, Apr. 1, 2018, 12 pages.
- Declaration of Thomas Pichler In Opposition To Tro Request, C.A. No. 1:18-cv-00462-GMS, Apr. 1, 2018, 8 pages.
- Exhibit A to Pichler Declaration ISO TRO Opposition (D.I. 13-1), C.A. No. 1:18-cv-00462-GMS, Apr. 1, 2018, 29 pages.
- Order TRO (D.I. 18), C.A. No. 1:18, Apr. 4, 2018, 3 pages.
- Defendant Soto Massini (USA) Corporation’s Answer and Counterclaims To Verified Complaint for Patent Infringement, Trade Dress Infringement, and Unfair Competition, C.A. No. 1:18-cv-00462-GMS, May 1, 2018, 26 pages.
- Defendant Soto Massini (USA) Corporation’s Answer To Amended Complaint and Amended Counterclaims, C.A. No. 1:18-cv-00462-GMS, Jun. 5, 2018, 28 pages.
- Defendant Soto Massini (USA) Corporation’s Answer To Amended Complaint and First Amended Counterclaims, C.A. No. 1:18-cv-00462-GMS, Jul. 12, 2018, 31 pages.
- Exhibit A to SACC (45-1), Case 1:18-cv-00462-GMS, 3 pages.
- Exhibit B to SACC (45-2), Case 1:18-cv-00462-GMS, 5 pages.

Exhibit C to SACC (45-3), Case 1:18-cv-00462-GMS, 5 pages.
 Exhibit D to SACC (45-4), Case 1:18-cv-00462-GMS, 4 pages.
 Defendant Soto-USA's Invalidity Contentions, C.A. No. 1:18-cv-00462-MN, 16 pages.
 Redacted Verdict Form (D.I. 144), Case 1:18-cv-00462-GMS, 13 pages.
 Judgement (D.I. 149), C.A. No. 18-462-MN, May 13, 2019, 3 pages.
Gavrieli Brands, LLC, v. Soto Massini (USA) Corp., et al., (full Trial Transcript, C.A. No. 18-462(MN), vol. 1, 733 pages.
 Expert Report of Caroline de Baere (Fed. R. CIV. P. 26(a)(2)(B), Case No. 18-cv-00462-MN, Mar. 1, 2019, 33 pages.
 Exhibit 23, Infringement Analysis in Light of the Alleged Prior Art, 41 pages.
 Expert Report of Lance Rake, (Fed. R. CIV. P. 26(a)(2)(B), Mar. 1, 2019, 27 pages.
 U.S. Pat. No. 1,525,848, Feb. 10, 1925, B. S. Bonaventure, 3 pages.
 U.S. Design Patent No. 247,396, Mar. 7, 1978, William A. Schlerth, 2 pages.
 U.S. Design Patent No. D611,693 S, Mar. 16, 2010, Barbara Schwartz, 7 pages.
 Camper Book Excerpt—Nina Right, (pp. 334-335), The Walking Society, Lars Müller Publishers, 3 pages.
 Camper History—The Shoes, Every Season We Strive to Reinvent Some of Our Classic Concepts While Continuing to Challenge The Status Quo With New and Original Designs. We Often Find That There is A Camper Style for Every Walk of Life, 8 pages.
 Tiefs by Gavrieli—Comfortable, designer flats you can fit in your purse and wear all day, every day!, Copperhead Snake Print Tiefs, <https://web.archive.org/web/20101230062534/http://www.tiefs.com:80/>, Dec. 30, 2010, 1 page.
 Tiefs by Gavrieli—Comfortable, designer flats you can fit in your purse and wear all day, every day!, Merlot Lizard Print Tiefs, <https://web.archive.org/web/20101230062534/http://www.tiefs.com:80/>, Dec. 30, 2010, 1 page.
 Tiefs by Gavrieli—Comfortable, designer flats you can fit in your purse and wear all day, every day!, Slate Grey Tiefs, <https://web.archive.org/web/20101230062534/http://www.tiefs.com:80/>, Dec. 30, 2010, 1 page.
 Tiefs by Gavrieli—Comfortable, designer flats you can fit in your purse and wear all day, every day!, Camel, <https://web.archive.org/web/20101230062534/http://www.tiefs.com:80/>, Dec. 30, 2010, 1 page.
 Tiefs by Gavrieli—Comfortable, designer flats you can fit in your purse and wear all day, every day!, Lilac, <https://web.archive.org/web/20101230062534/http://www.tiefs.com:80/>, Dec. 30, 2010, 1 page.
 Tiefs by Gavrieli—Comfortable, designer flats you can fit in your purse and wear all day, every day!, Leopard Print, <https://web.archive.org/web/20101230062534/http://www.tiefs.com:80/>, Dec. 30, 2010, 1 page.
 Tiefs by Gavrieli—Comfortable, designer flats you can fit in your purse and wear all day, every day!, The Tiefs eGift card . . . Always the perfect fit, <https://web.archive.org/web/20101230062534/http://www.tiefs.com:80/>, Dec. 30, 2010, 1 page.
 Tiefs by Gavrieli—Comfortable, designer flats you can fit in your purse and wear all day, every day!, Copperhead Snake Print, <https://web.archive.org/web/20110222174850/http://www.tiefs.com:80/> Feb. 22, 2011, 1 page.
 Tiefs by Gavrieli—Comfortable, designer flats you can fit in your purse and wear all day, every day!, Patent Tiek Blue, <https://web.archive.org/web/20110222174850/http://www.tiefs.com:80/>, Feb. 22, 2011, 1 page.
 Tiefs by Gavrieli—Comfortable, designer flats you can fit in your purse and wear all day, every day!, Tangerine, <https://web.archive.org/web/20110222174850/http://www.tiefs.com:80/>, Feb. 22, 2011, 1 page.
 Tiefs by Gavrieli—Fashionable Flats That Fit in Your Purse California Navy, <https://web.archive.org/web/20100516173039/http://www.tiefs.com:80/california-navy.html>, May 16, 2010, 1 page.
 Tiefs by Gavrieli—Fashionable Flats That Fit in Your Purse Cardinal Red, <https://web.archive.org/web/20100516173045/http://www.tiefs.com:80/cardinal-red.html>, May 16, 2010, 1 page.

Tiefs by Gavrieli—Fashionable Flats That Fit in Your Purse Metallic Gold, <https://web.archive.org/web/20100516173106/tiefs.com/metallic-gold.html>, May 16, 2010, 1 page.
 Tiefs by Gavrieli—Fashionable Flats That Fit in Your Purse Patent Tiek Blue, <https://web.archive.org/web/20100516173130/http://www.tiefs.com:80/tiek-blue.html>, May 16, 2010, 1 page.
 Tiefs by Gavrieli—Fashionable Flats That Fit in Your Purse Splash Page, The Ballet Flat . . . Reinvented, <https://web.archive.org/web/20100513055818/https://tiefs.com/>, May 13, 2010, 1 page.
 Tiefs by Gavrieli—Fashionable Flats That Fit in Your Purse Splash Page, Ballet Flats . . . with a Bonus, <https://web.archive.org/web/20100513055818/https://tiefs.com/>, May 13, 2010, 1 page.
 Tiefs by Gavrieli—Fashionable Flats That Fit in Your Purse Splash Page, Going Places? Take Tiefs. <https://web.archive.org/web/20100513055818/https://tiefs.com/>, May 13, 2010, 1 page.
 Tiefs by Gavrieli—Fashionable Flats That Fit in Your Purse Splash Page, Step Into Tiefs, <https://web.archive.org/web/20100513055818/https://tiefs.com/>, May 13, 2010, 1 page.
 Tiefs by Gavrieli—Fashionable Flats That Fit in Your Purse True Blue, <https://web.archive.org/web/20100516173135/http://www.tiefs.com:80/true-blue.html>, May 16, 2010, 1 page.
 Tiefs by Gavrieli—Fashionable Flats That Fit in Your Purse White Croc Print, <https://web.archive.org/web/20100516173145/http://tiefs.com:80/white-croc-print.html>, May 16, 2010, 1 page.
 Tiefs by Gavrieli—Foldable Fashionable Ballet Flats, Wild Copper, Be a little wild . . . even when you're not., <https://web.archive.org/web/20100819165503/https://tiefs.com/>, Aug. 19, 2010, 1 page.
 Tiefs by Gavrieli—Foldable Fashionable Ballet Flats, Paradise Blue, The perfect pair for day and night, <https://web.archive.org/web/20100819165503/https://tiefs.com/>, Aug. 19, 2010, 1 page.
 Tiefs by Gavrieli—Foldable Fashionable Ballet Flats, Obsidian Black, When workdays spill over into party nights., <https://web.archive.org/web/20100819165503/https://tiefs.com/>, Aug. 19, 2010, 1 page.
 Tiefs by Gavrieli—Foldable Fashionable Ballet Flats, Fuchsia, Sweet and sultry, <https://web.archive.org/web/20100819165503/https://tiefs.com/>, Aug. 19, 2010, 1 page.
 Tiefs by Gavrieli—Foldable Fashionable Ballet Flats, Tan Croc print Tiefs, A timeless texture., <https://web.archive.org/web/20100819165503/https://tiefs.com/>, Aug. 19, 2010, 1 page.
 Tiefs by Gavrieli—Foldable Fashionable Ballet Flats, Be a little wild . . . even when you're not., <https://web.archive.org/web/20100902020755/https://tiefs.com/>, Sep. 2, 2010, 1 page.
 Tiefs by Gavrieli—Foldable Fashionable Ballet Flats, Obsidian Black, When workdays spill over into party nights. <https://web.archive.org/web/20100902020755/https://tiefs.com/>, Sep. 2, 2010, 1 page.
 Tiefs by Gavrieli—Foldable Fashionable Ballet Flats, Tan Croc Print, A timeless texture, <https://web.archive.org/web/20100902020755/https://tiefs.com/> Sep. 2, 2010, 1 page.
 Tiefs by Gavrieli—Foldable Fashionable Ballet Flats, Paradise Blue, The perfect pair for day and night, <https://web.archive.org/web/20100902020755/https://tiefs.com/>, Sep. 2, 2010, 1 page.
 Tiefs by Gavrieli—Foldable Fashionable Ballet Flats, Fuchsia, Sweet and sultry, <https://web.archive.org/web/20100902020755/https://tiefs.com/>, Sep. 2, 2010, 1 page.
 Tiefs by Gavrieli—Foldable Fashionable Ballet Flats, Tiek Blue Tiefs, Let yourself shine, <https://web.archive.org/web/20100902020755/https://tiefs.com/>, Sep. 2, 2010, 1 page.

* cited by examiner

Primary Examiner — Jonathan J Han
 (74) *Attorney, Agent, or Firm* — Morgan, Lewis & Bockius LLP

(57)

CLAIM

The ornamental design for a shoe with outsole patch, as shown and described.

DESCRIPTION

The file of this patent contains at least one drawing executed in color. Copies of this patent with color drawing(s) will be provided by the Office upon request and payment of the necessary fee.

FIG. 1 is a perspective view of an embodiment of our new design of a shoe with outsole patch, wherein the outsole patch has been colored green;

FIG. 2 is a first side view of the design of FIG. 1;

FIG. 3 is a second side view of the design of FIG. 1;

FIG. 4 is a top view of the design of FIG. 1;

FIG. 5 is a bottom view of the design of FIG. 1;

FIG. 6 is a front view of the design of FIG. 1;

FIG. 7 is a back view of the design of FIG. 1;

FIG. 8 is a perspective view of another embodiment of our new design of a shoe with outsole patch, wherein the outsole patch has been colored orange;

FIG. 9 is a first side view of the design of FIG. 8;

FIG. 10 is a second side view of the design of FIG. 8;

FIG. 11 is a top view of the design of FIG. 8;

FIG. 12 is a bottom view of the design of FIG. 8;

FIG. 13 is a front view of the design of FIG. 8;

FIG. 14 is a back view of the design of FIG. 8;

FIG. 15 is a perspective view of another embodiment of our new design of a shoe with outsole patch, wherein the outsole patch has been colored purple;

FIG. 16 is a first side view of the design of FIG. 15;

FIG. 17 is a second side view of the design of FIG. 15;

FIG. 18 is a top view of the design of FIG. 15;

FIG. 19 is a bottom view of the design of FIG. 15;

FIG. 20 is a front view of the design of FIG. 15;

FIG. 21 is a back view of the design of FIG. 15;

FIG. 22 is a perspective view of another embodiment of our new design of a shoe with outsole patch, wherein the outsole patch has been colored red;

FIG. 23 is a first side view of the design of FIG. 22;

FIG. 24 is a second side view of the design of FIG. 22;

FIG. 25 is a top view of the design of FIG. 22;

FIG. 26 is a bottom view of the design of FIG. 22;

FIG. 27 is a front view of the design of FIG. 22;

FIG. 28 is a back view of the design of FIG. 22;

FIG. 29 is a perspective view of another embodiment of our new design of a shoe with outsole patch, wherein the outsole patch has been colored yellow;

FIG. 30 is a first side view of the design of FIG. 29;

FIG. 31 is a second side view of the design of FIG. 29;

FIG. 32 is a top view of the design of FIG. 29;

FIG. 33 is a bottom view of the design of FIG. 29;

FIG. 34 is a front view of the design of FIG. 29; and,

FIG. 35 is a back view of the design of FIG. 29.

The broken lines in the figure views depict portions of the shoe with outsole patch that form no part of the claimed design.

**1 Claim, 30 Drawing Sheets
(25 of 30 Drawing Sheet(s) Filed in Color)**

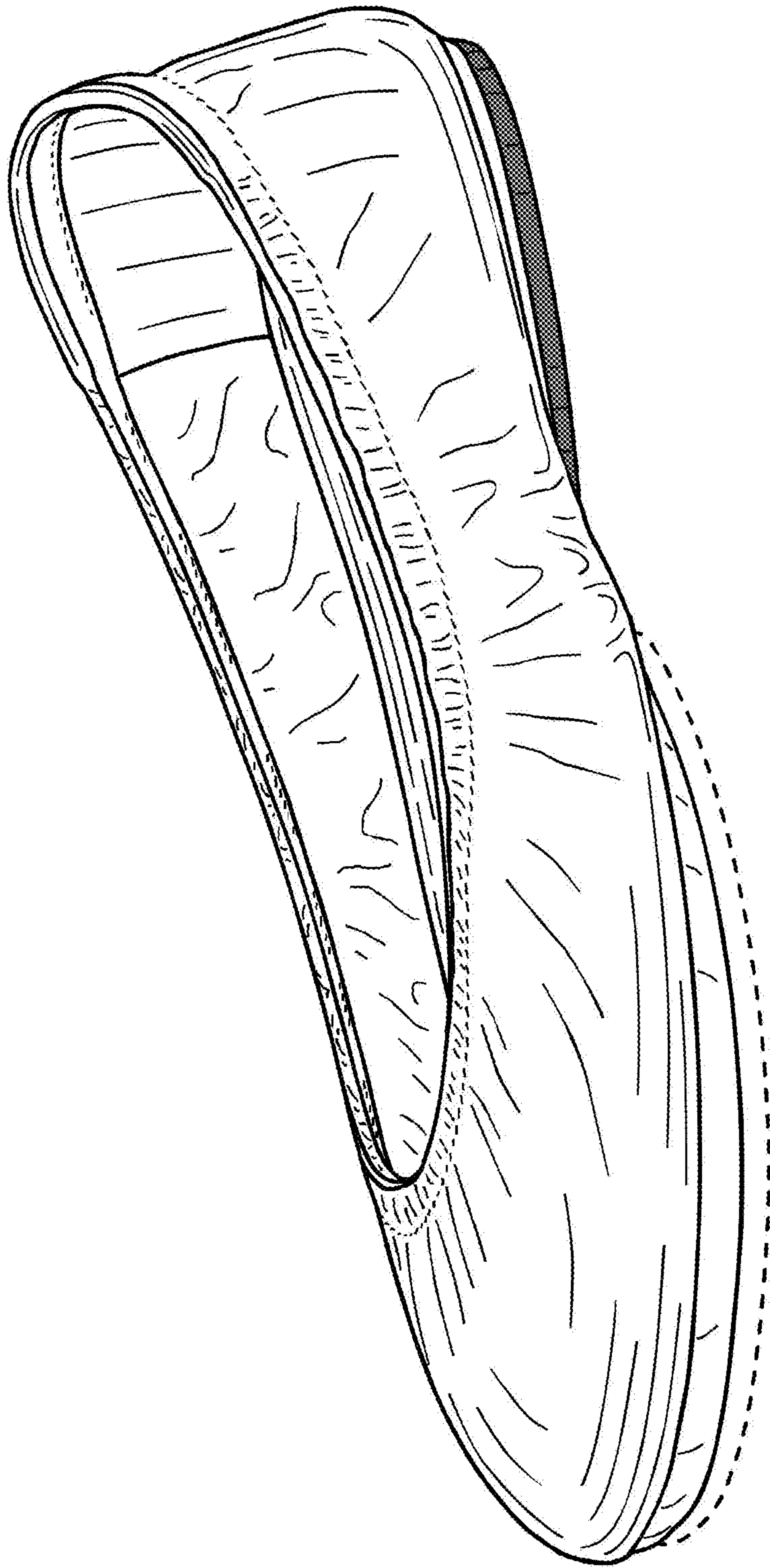

FIG. 1

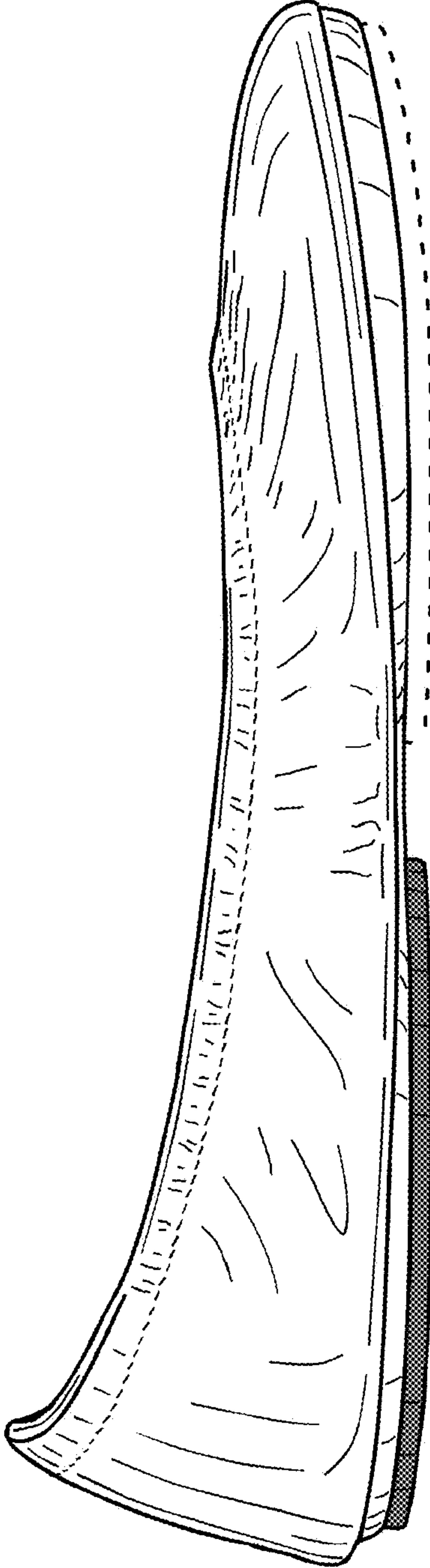

FIG. 2

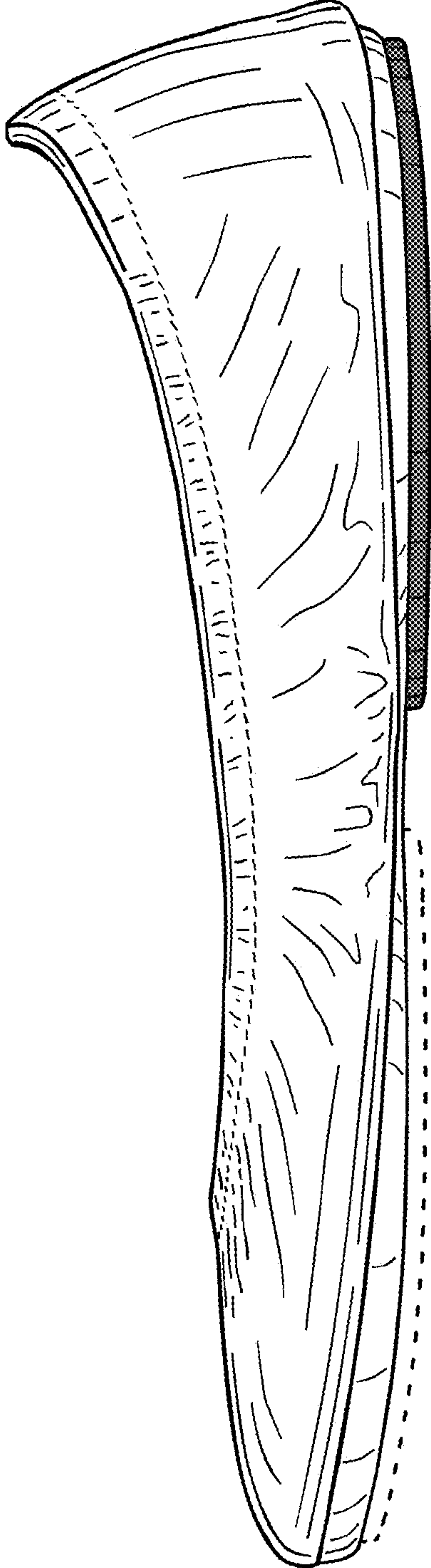

FIG. 3

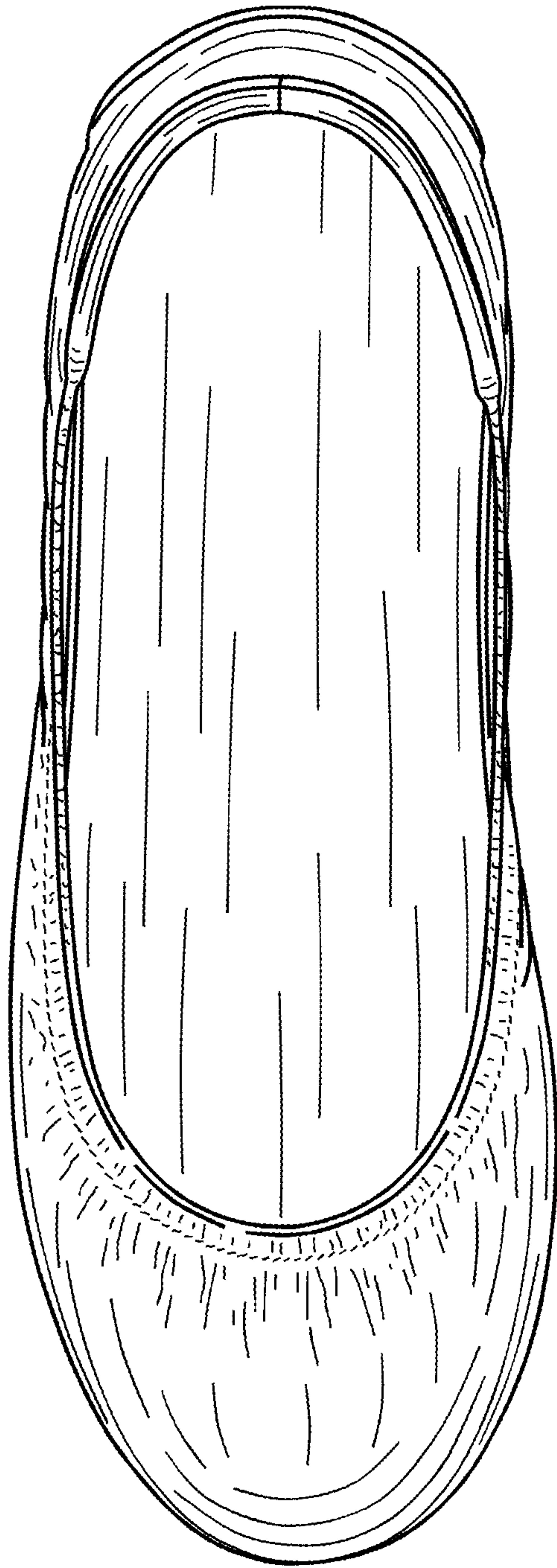

FIG. 4

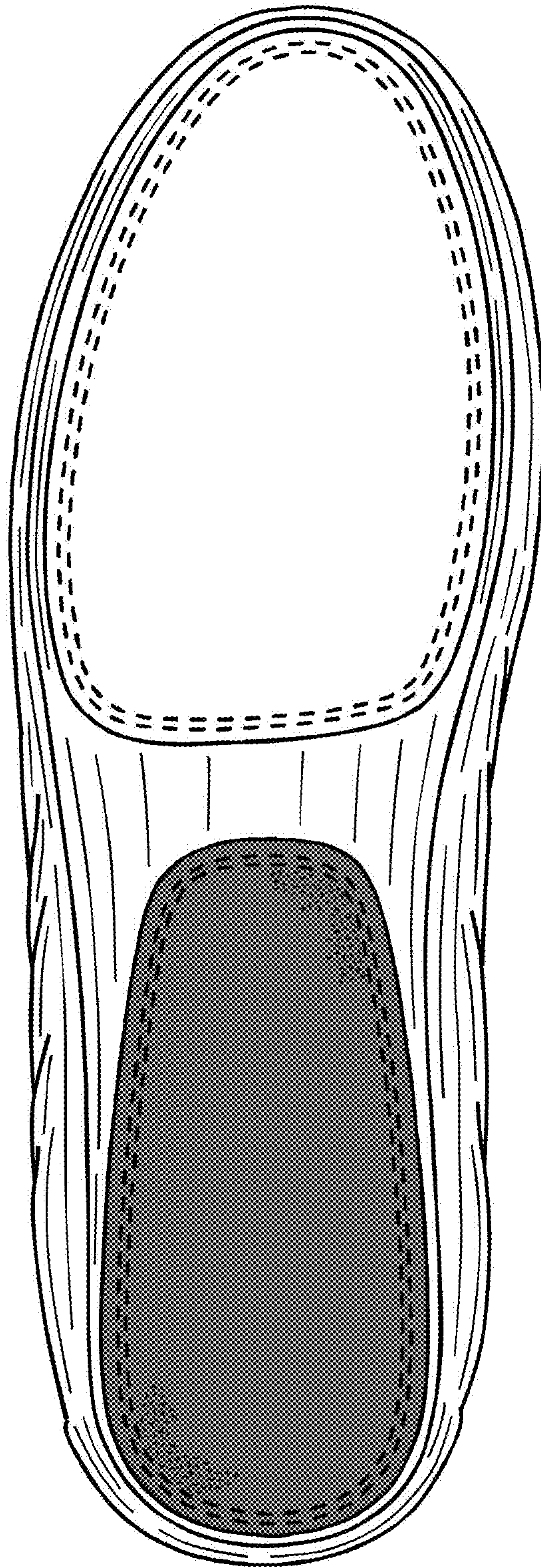

FIG. 5

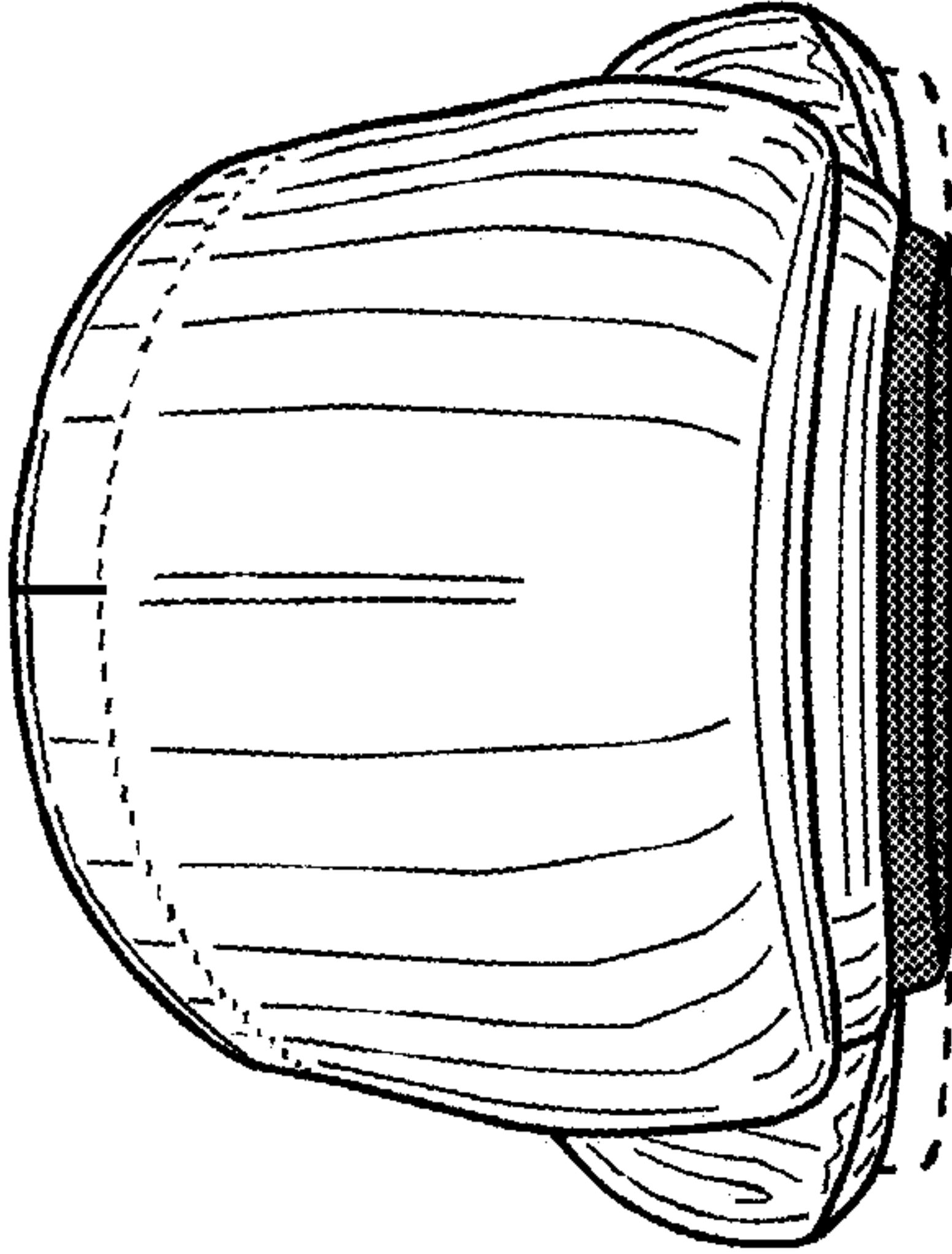

FIG. 7

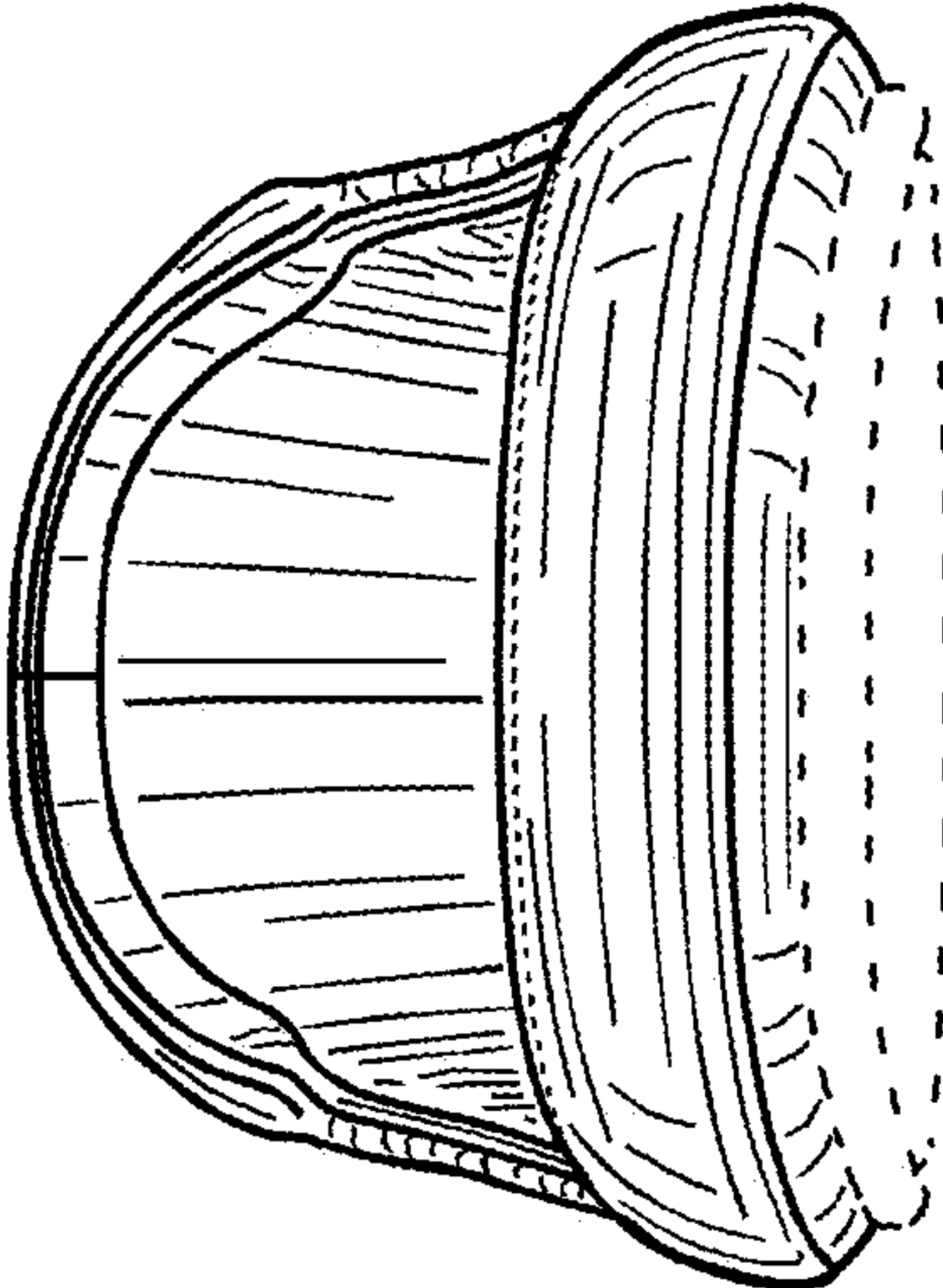

FIG. 6

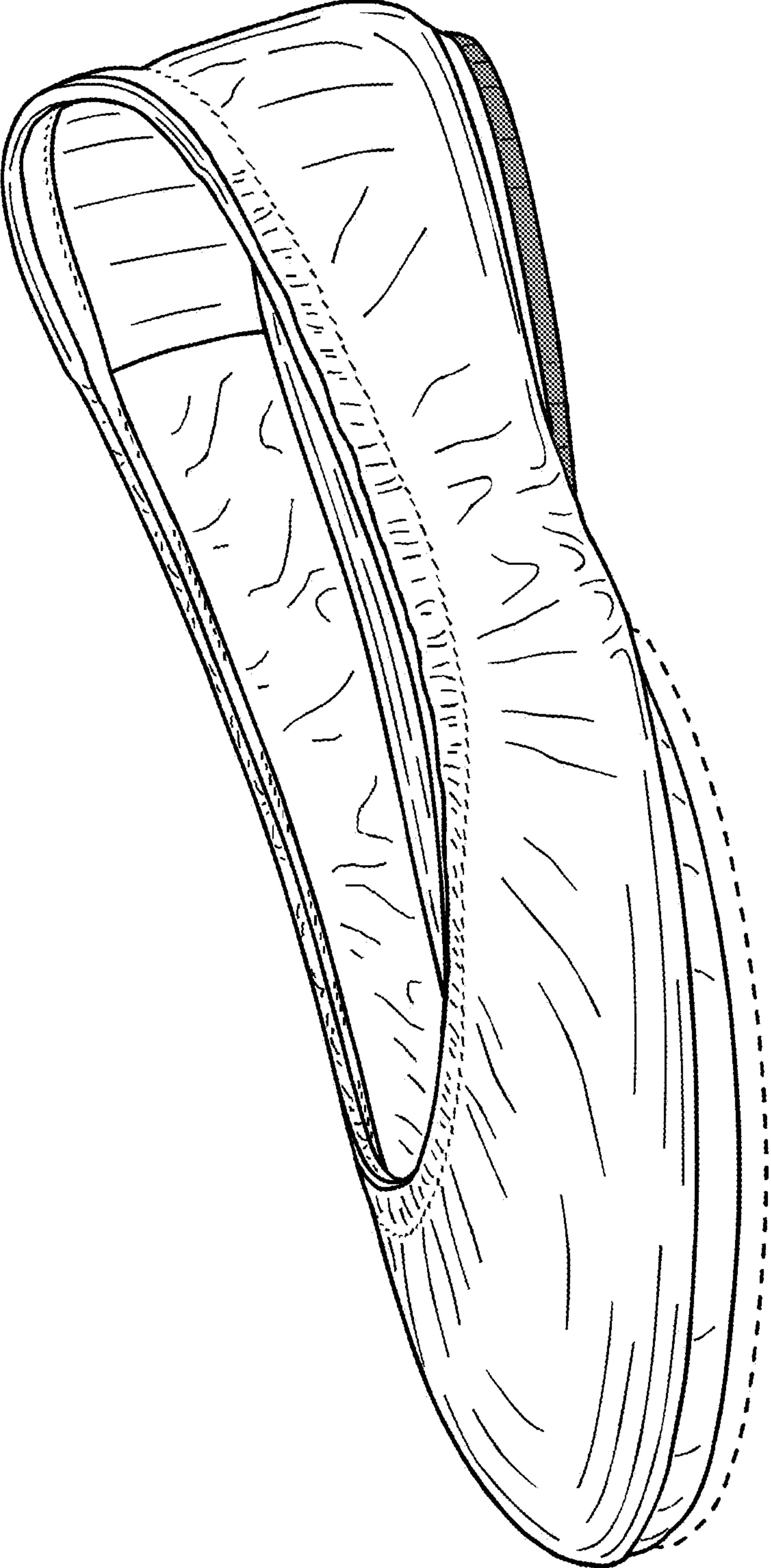

FIG. 8

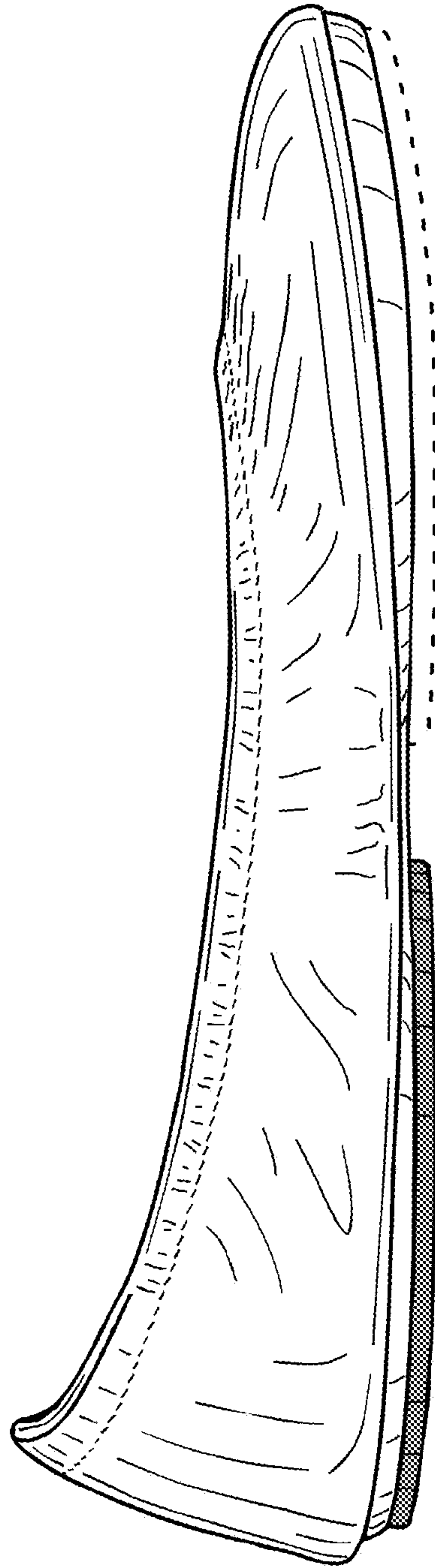

FIG. 9

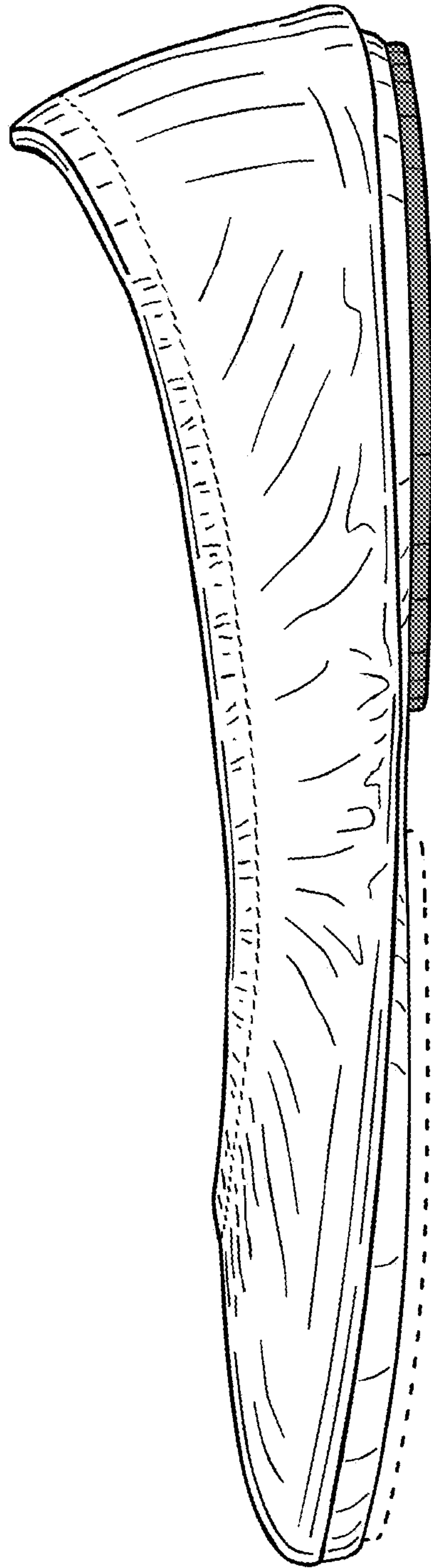

FIG. 10

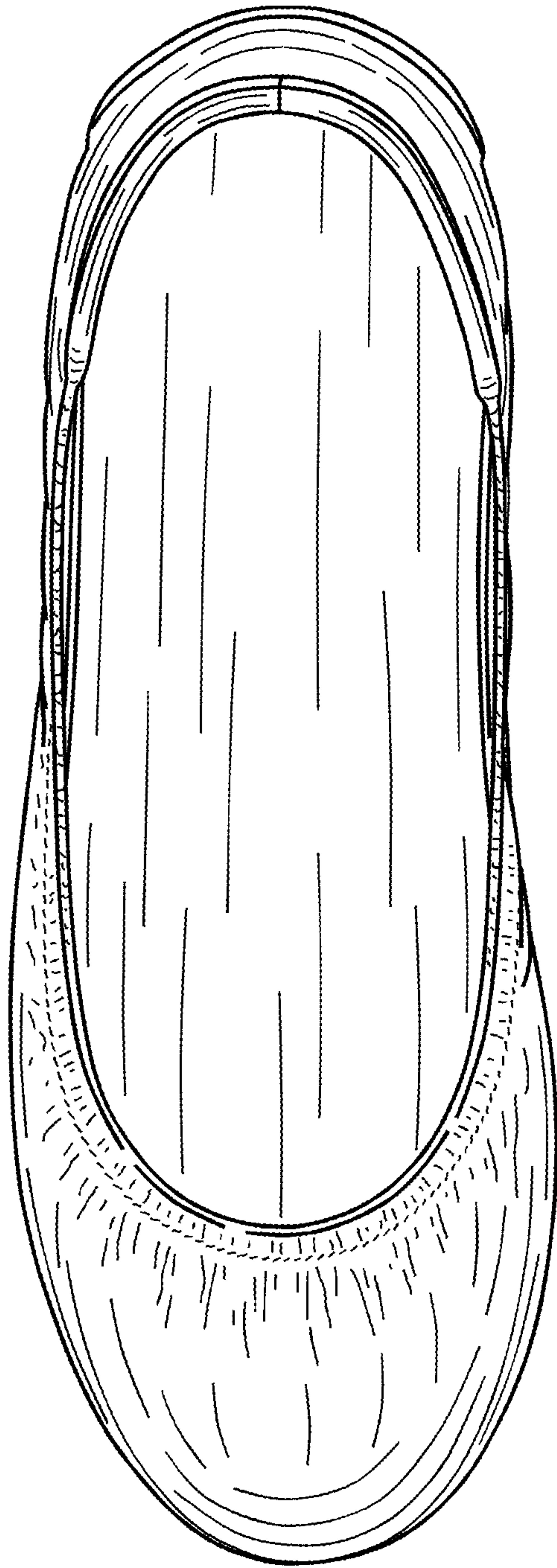

FIG. 11

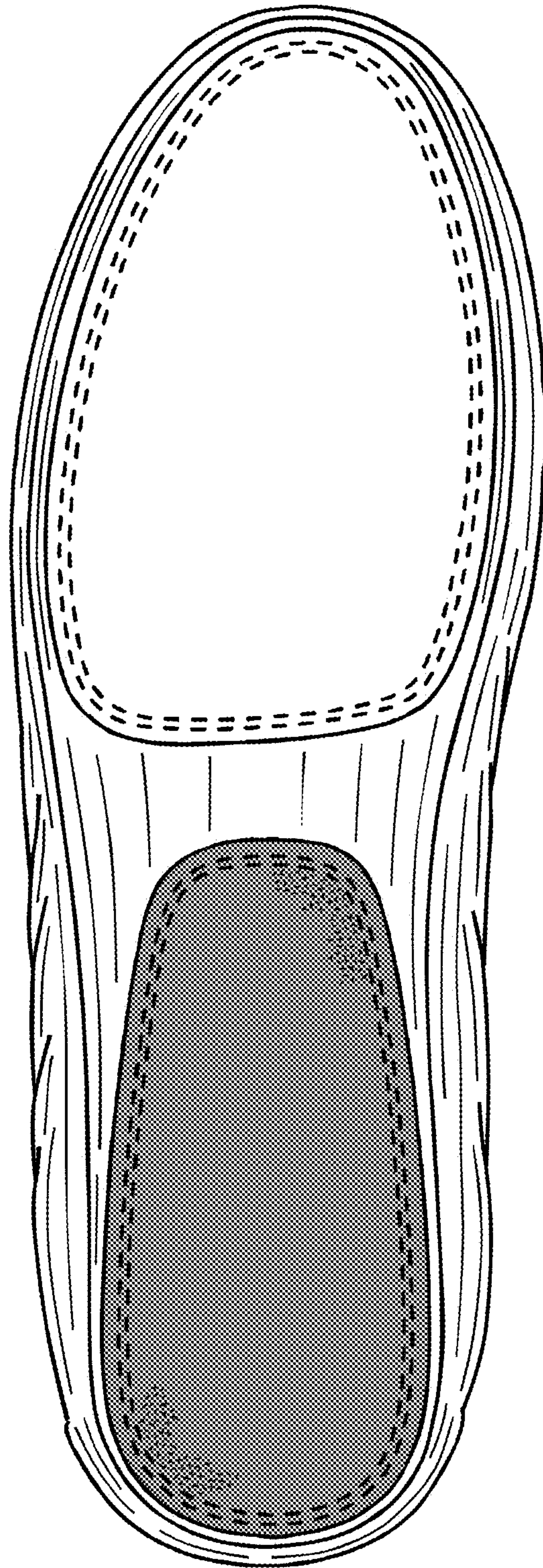

FIG. 12

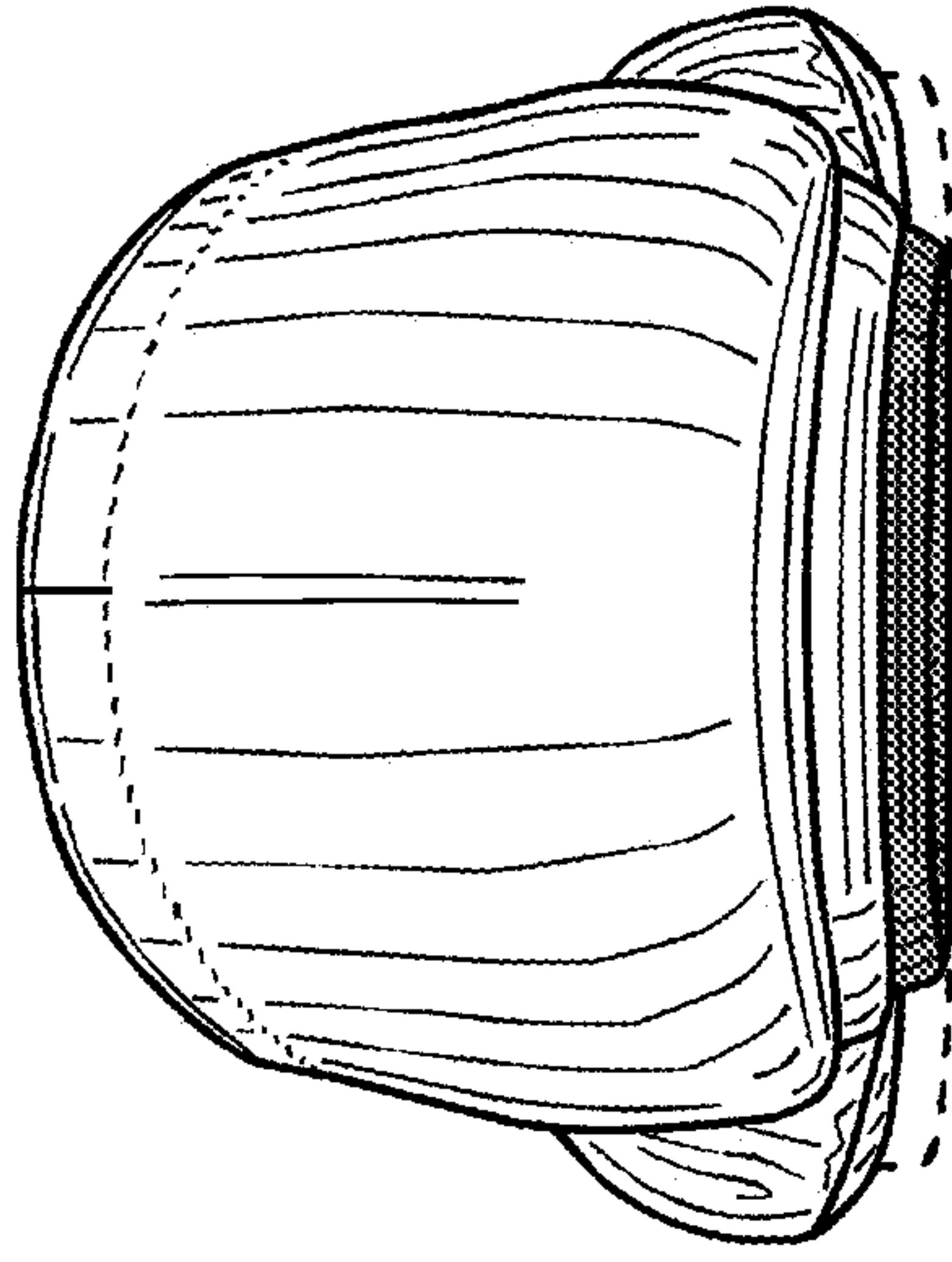

FIG. 14

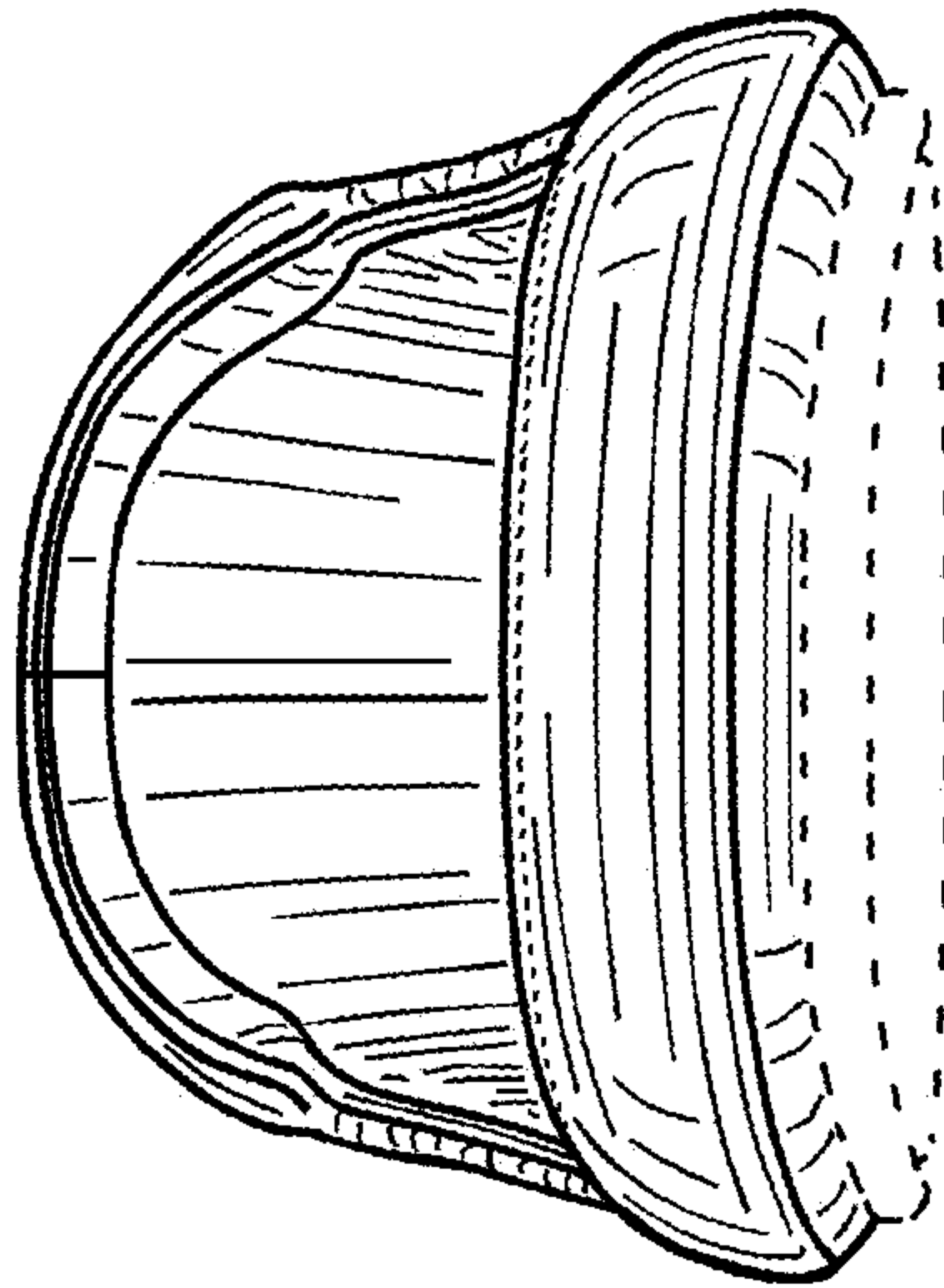

FIG. 13

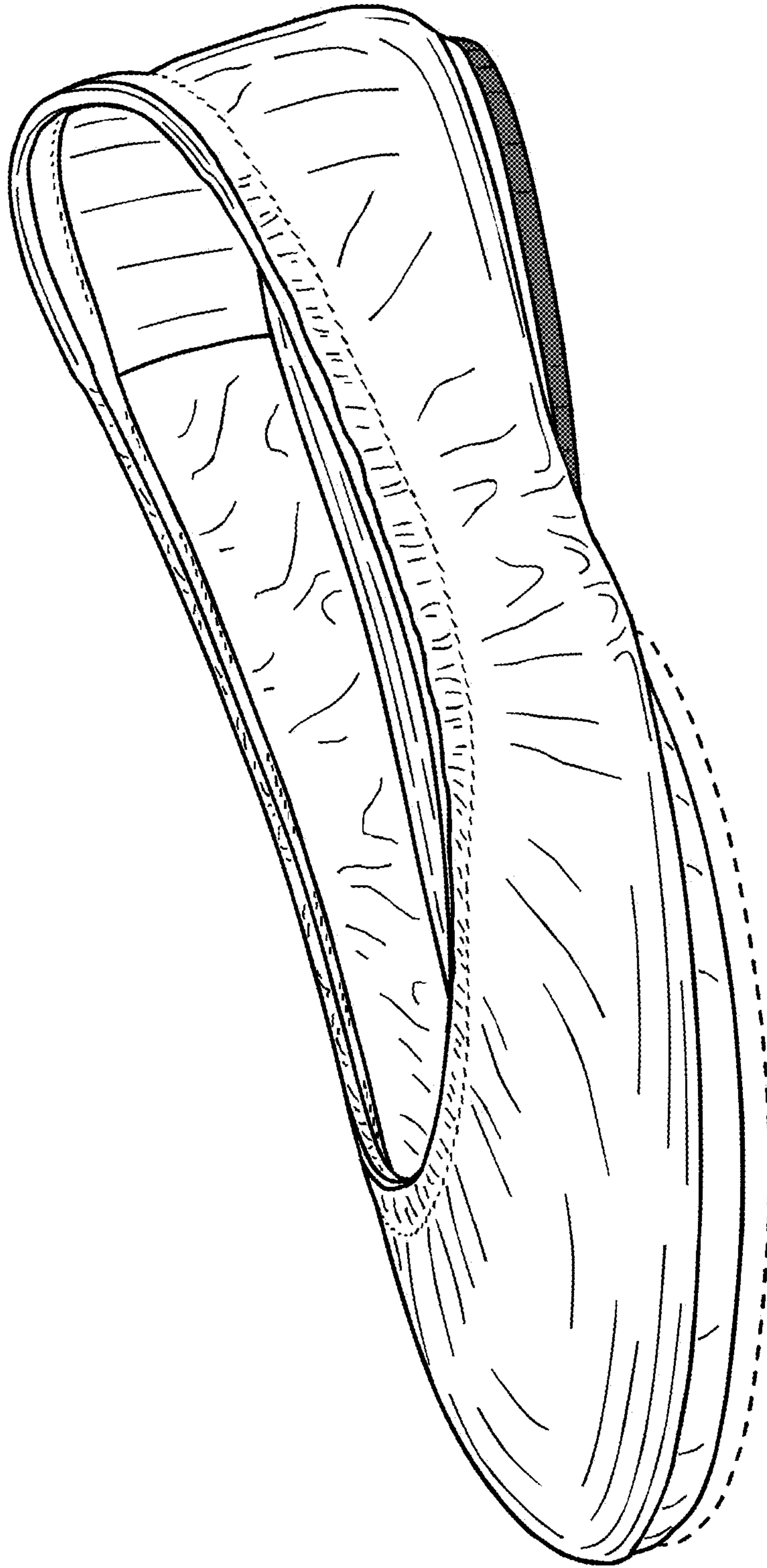

FIG. 15

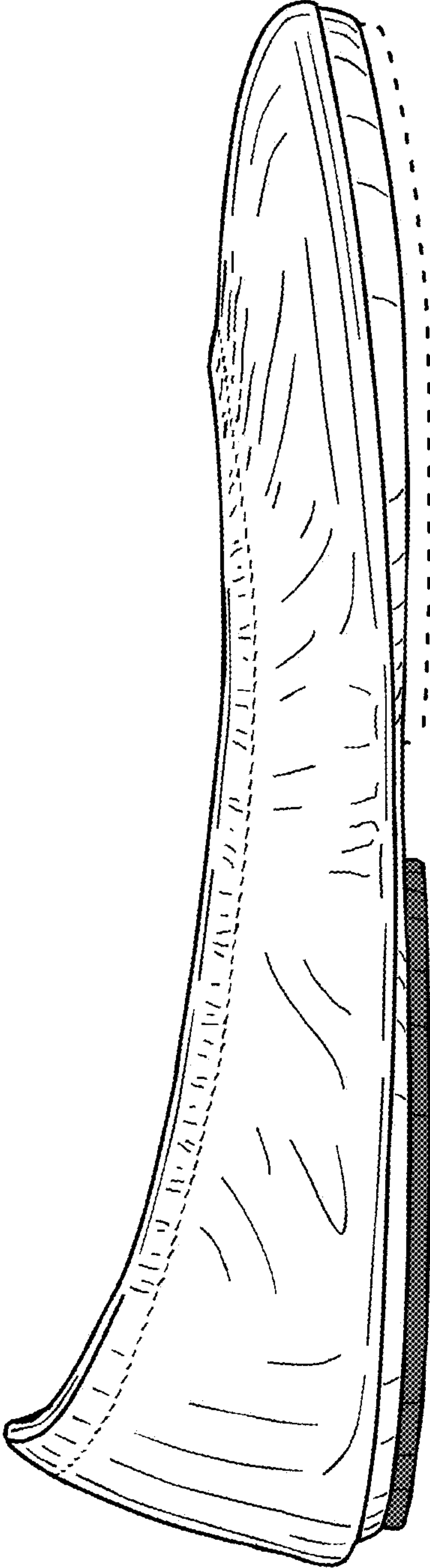

FIG. 16

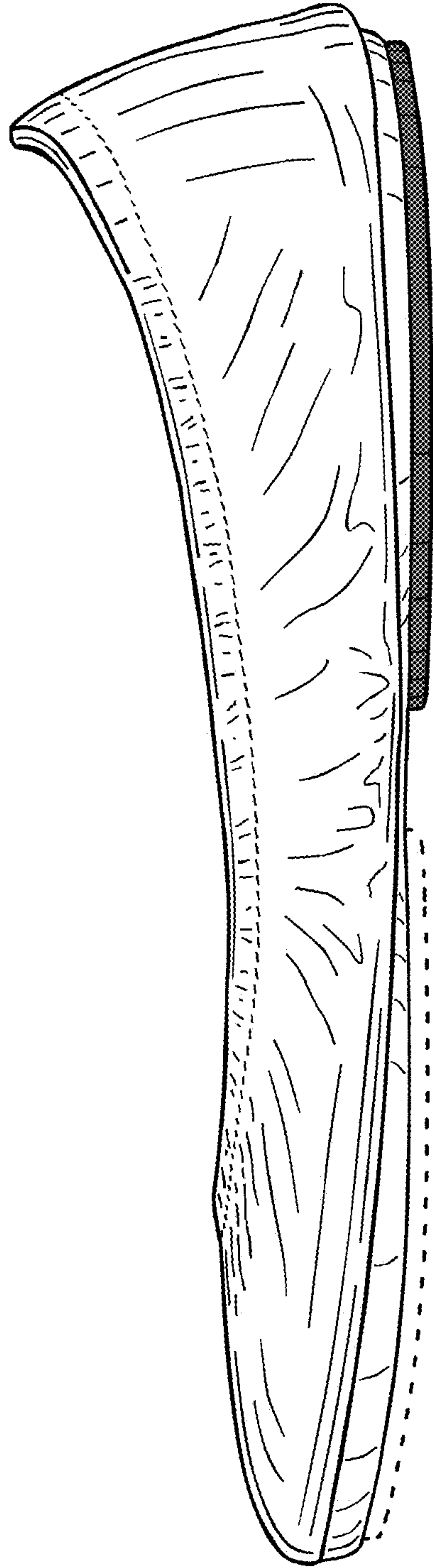

FIG. 17

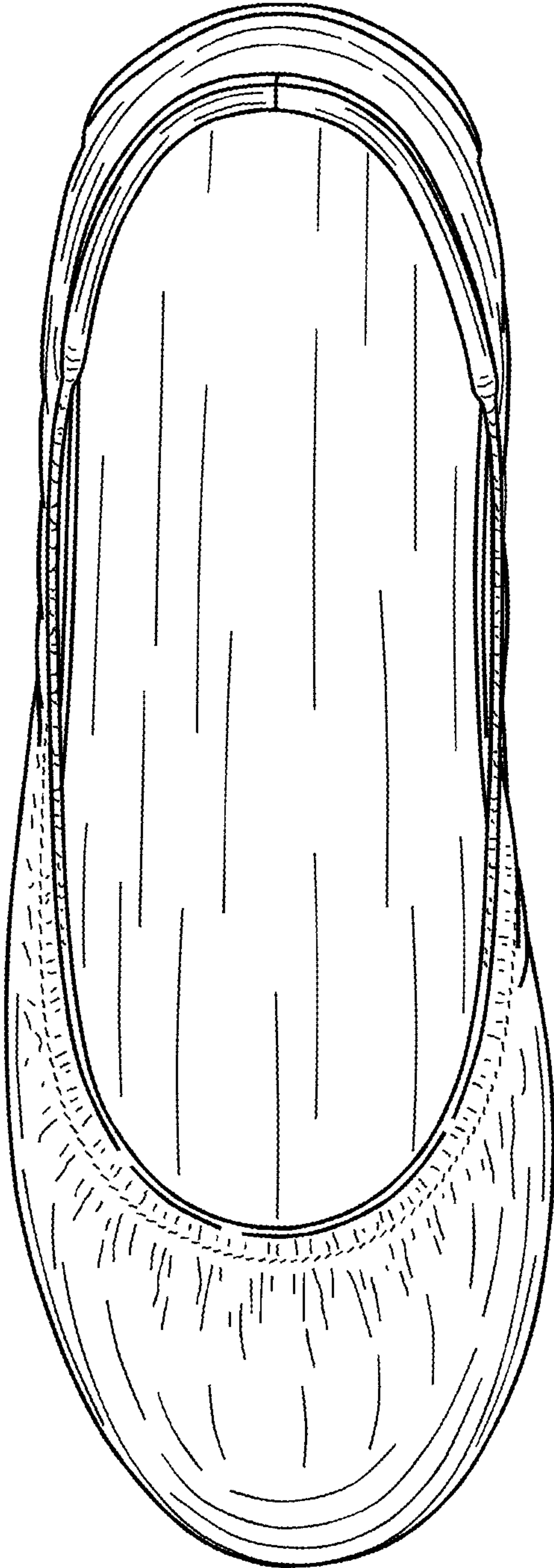

FIG. 18

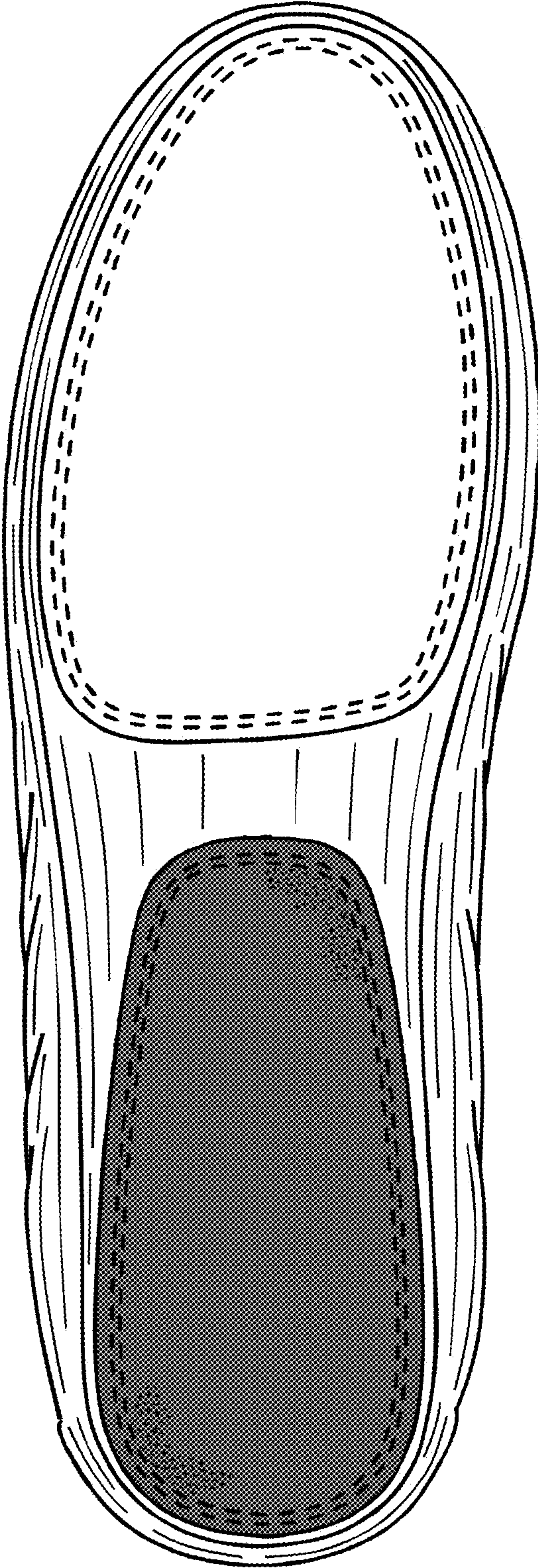

FIG. 19

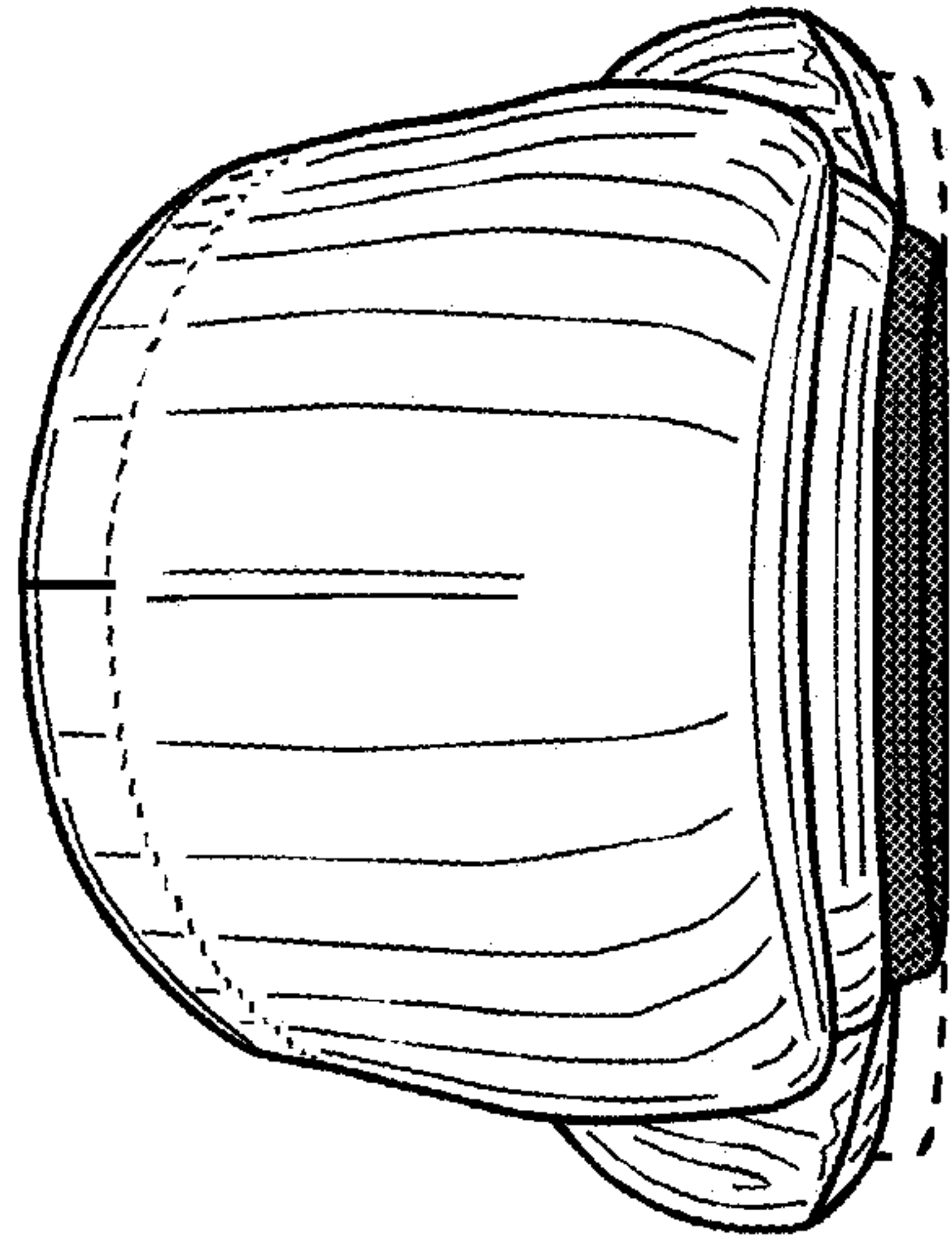

FIG. 21

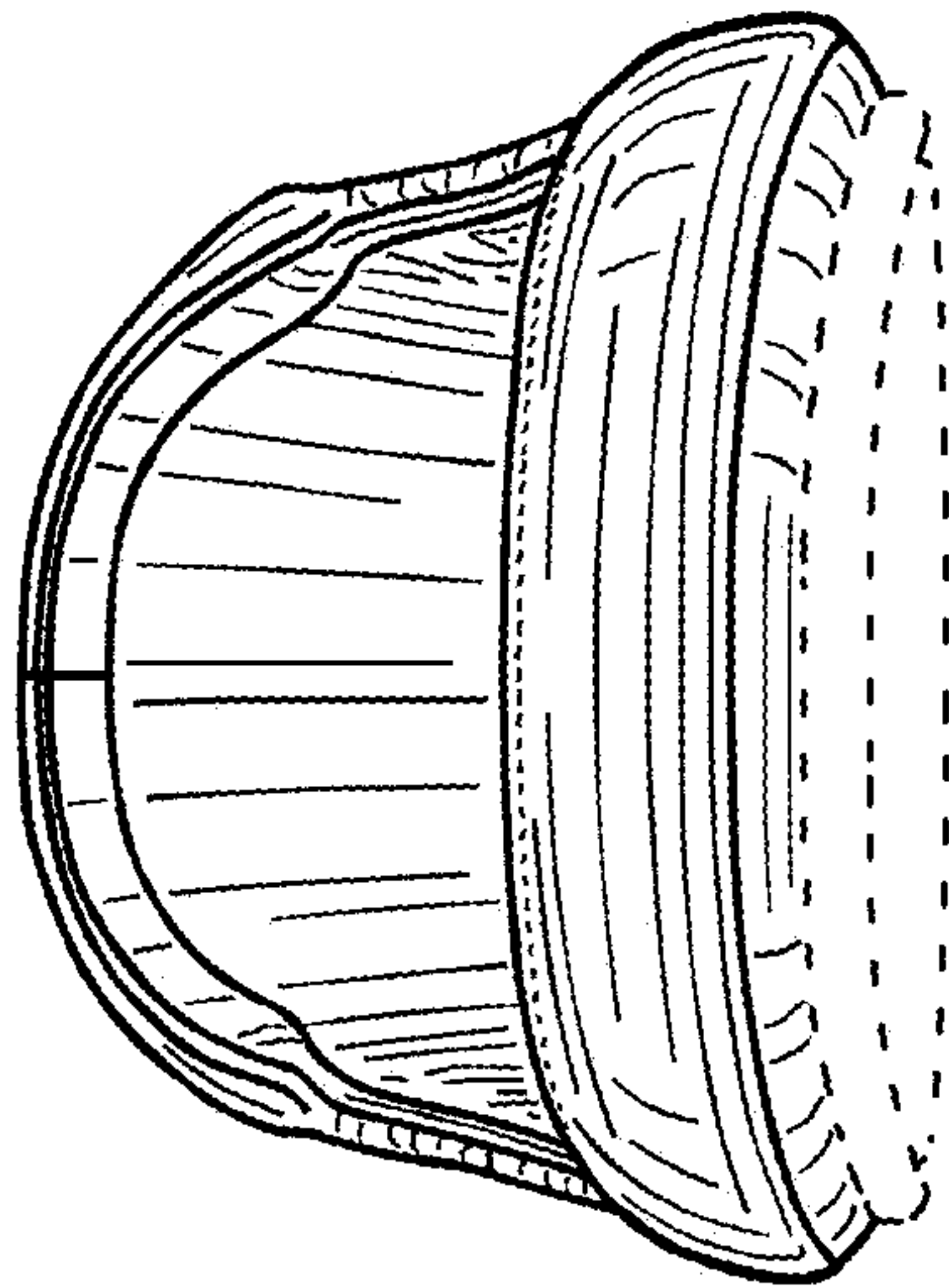

FIG. 20

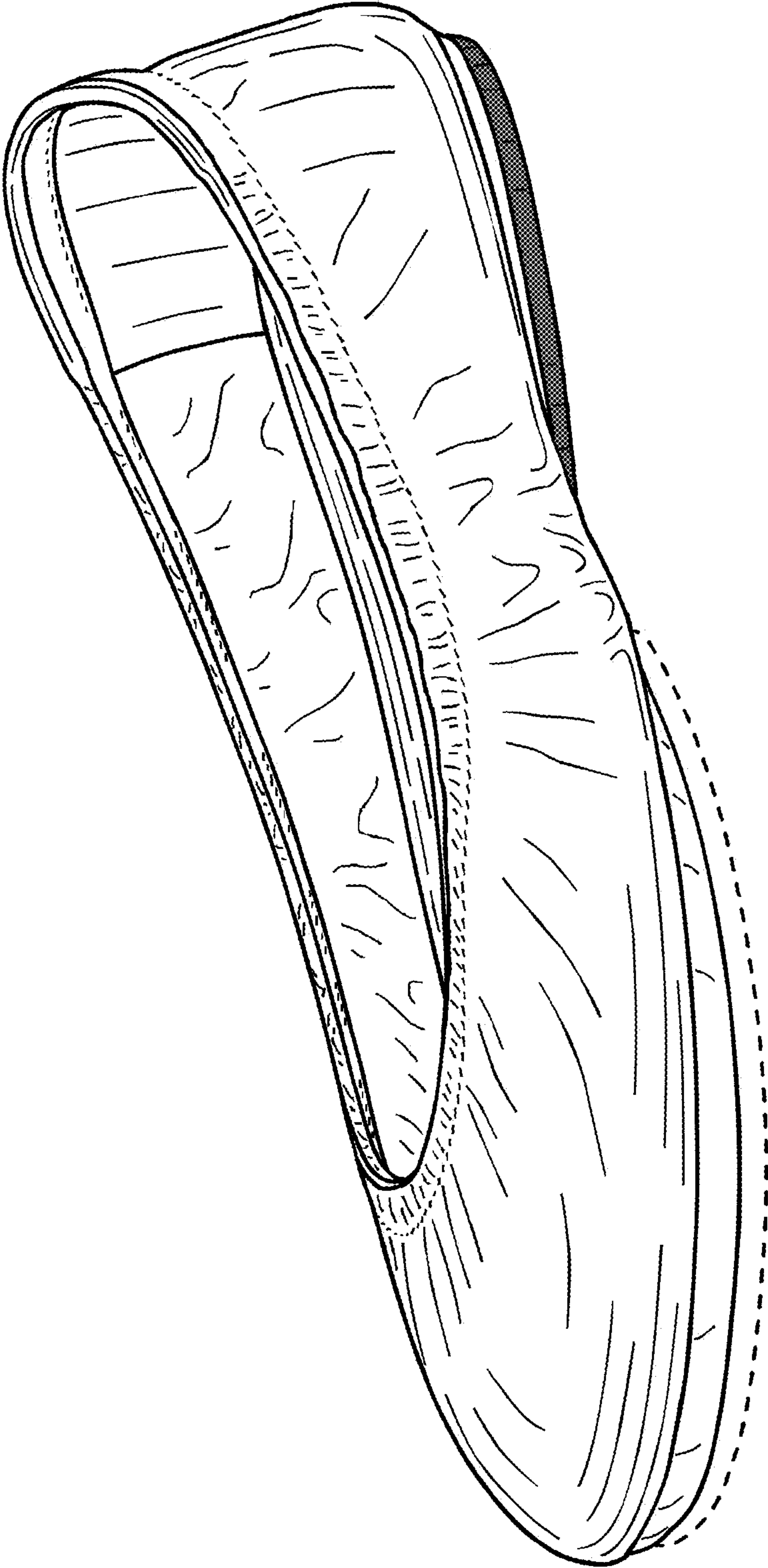

FIG. 22

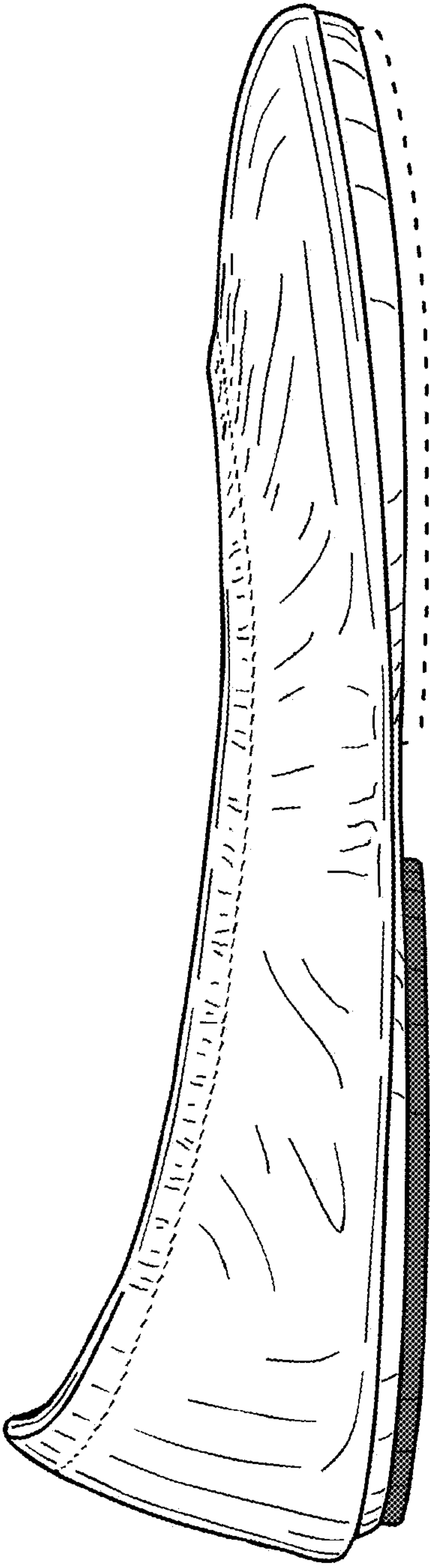

FIG. 23

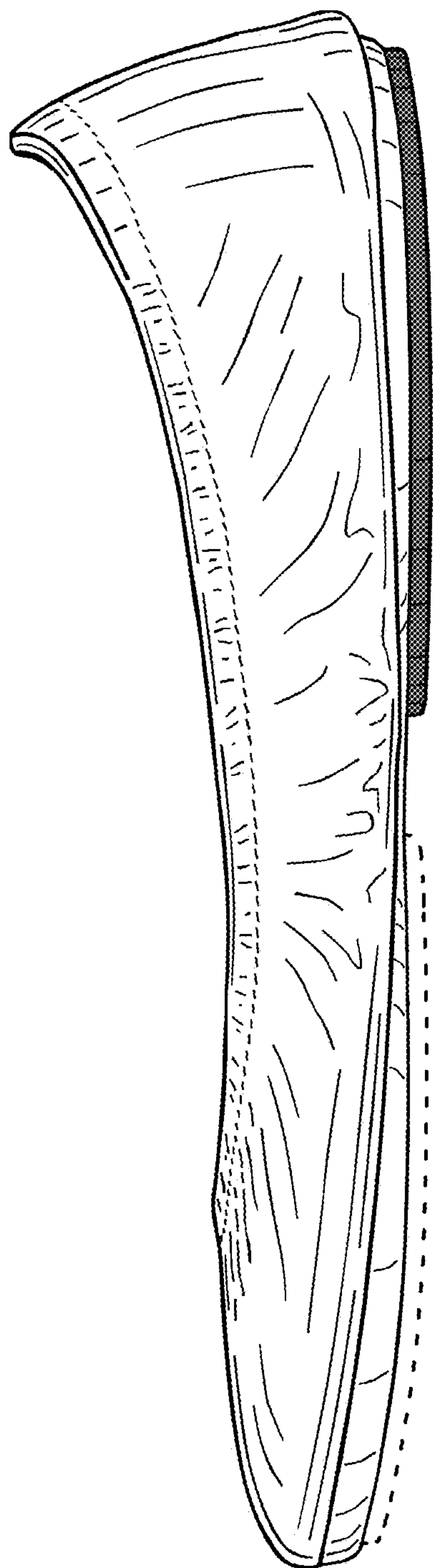

FIG. 24

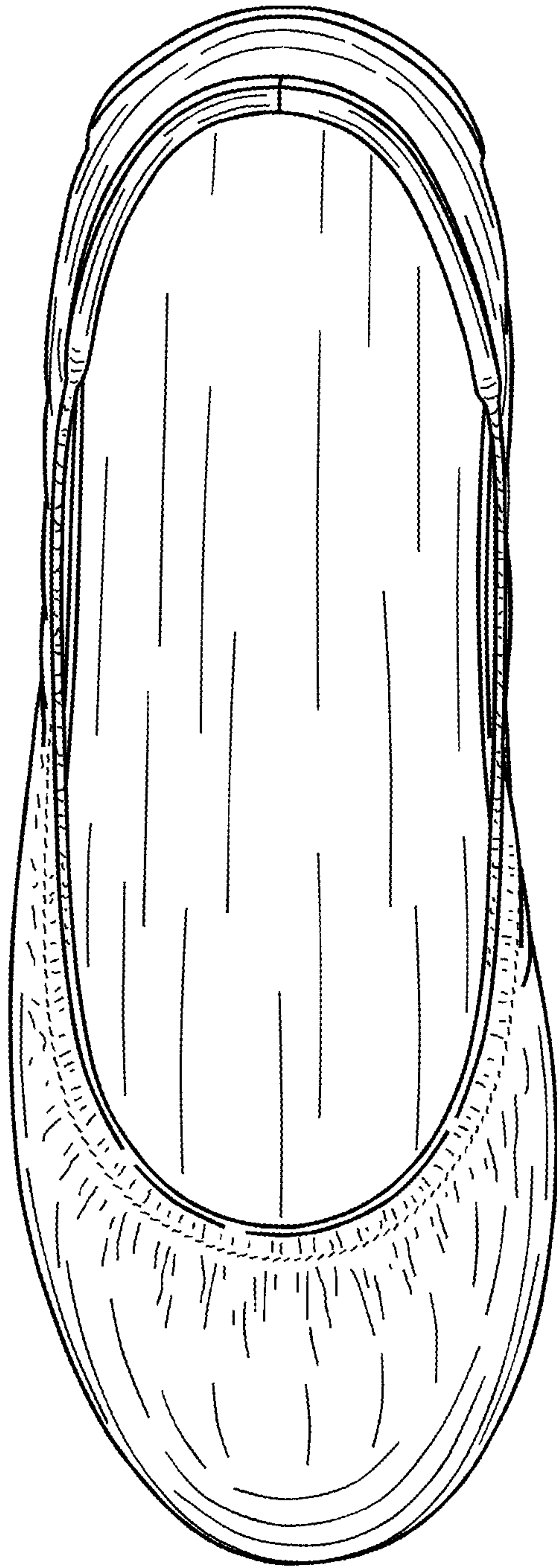

FIG. 25

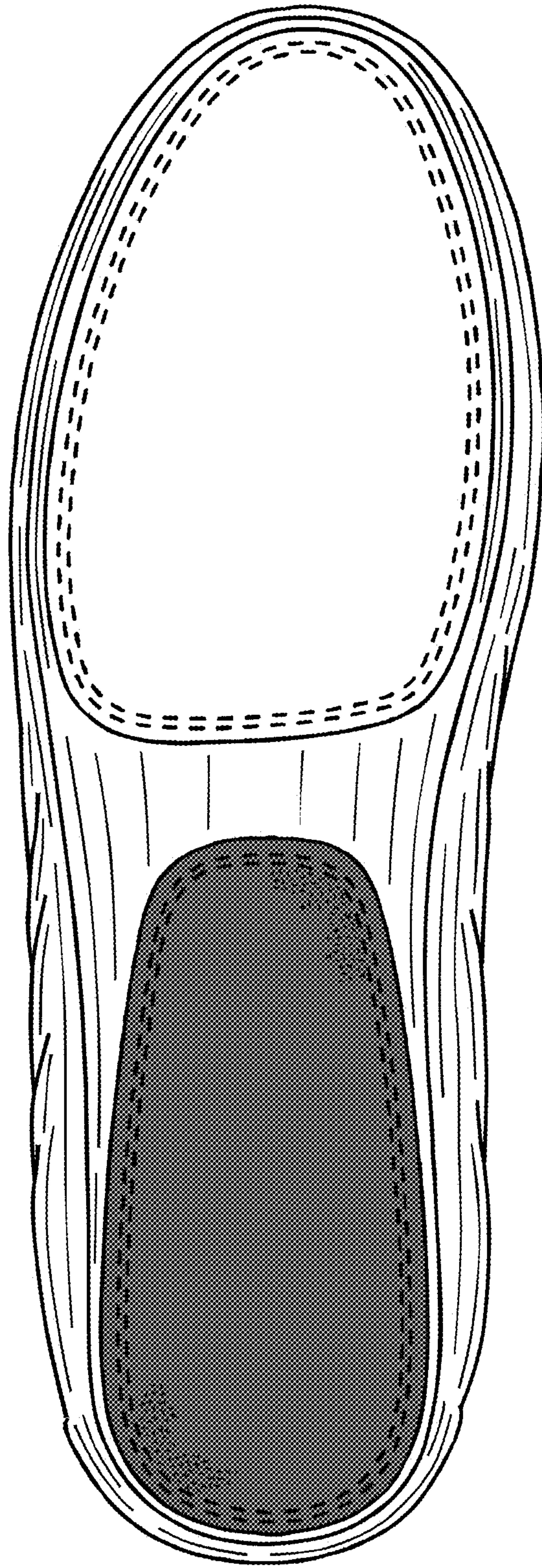

FIG. 26

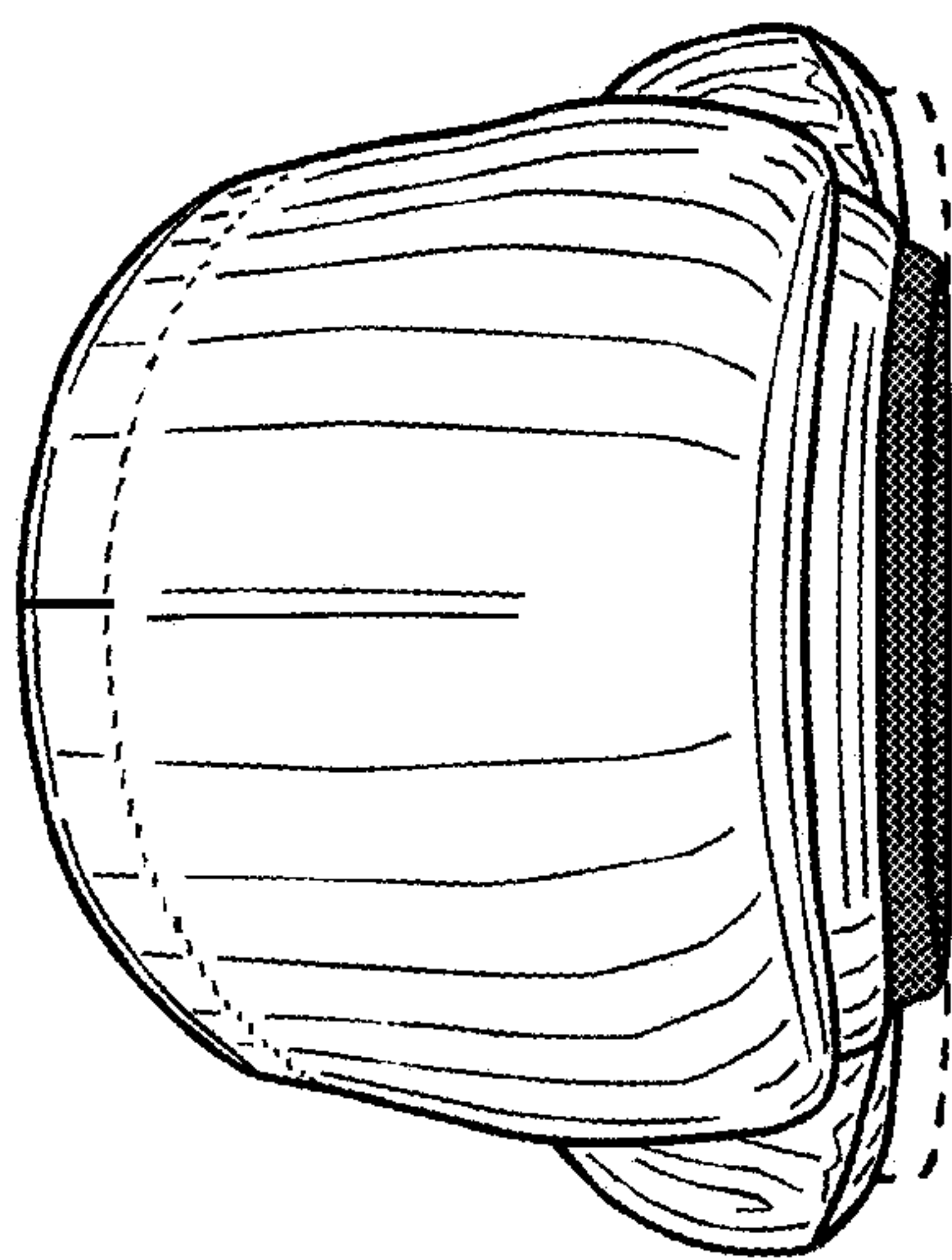

FIG. 28

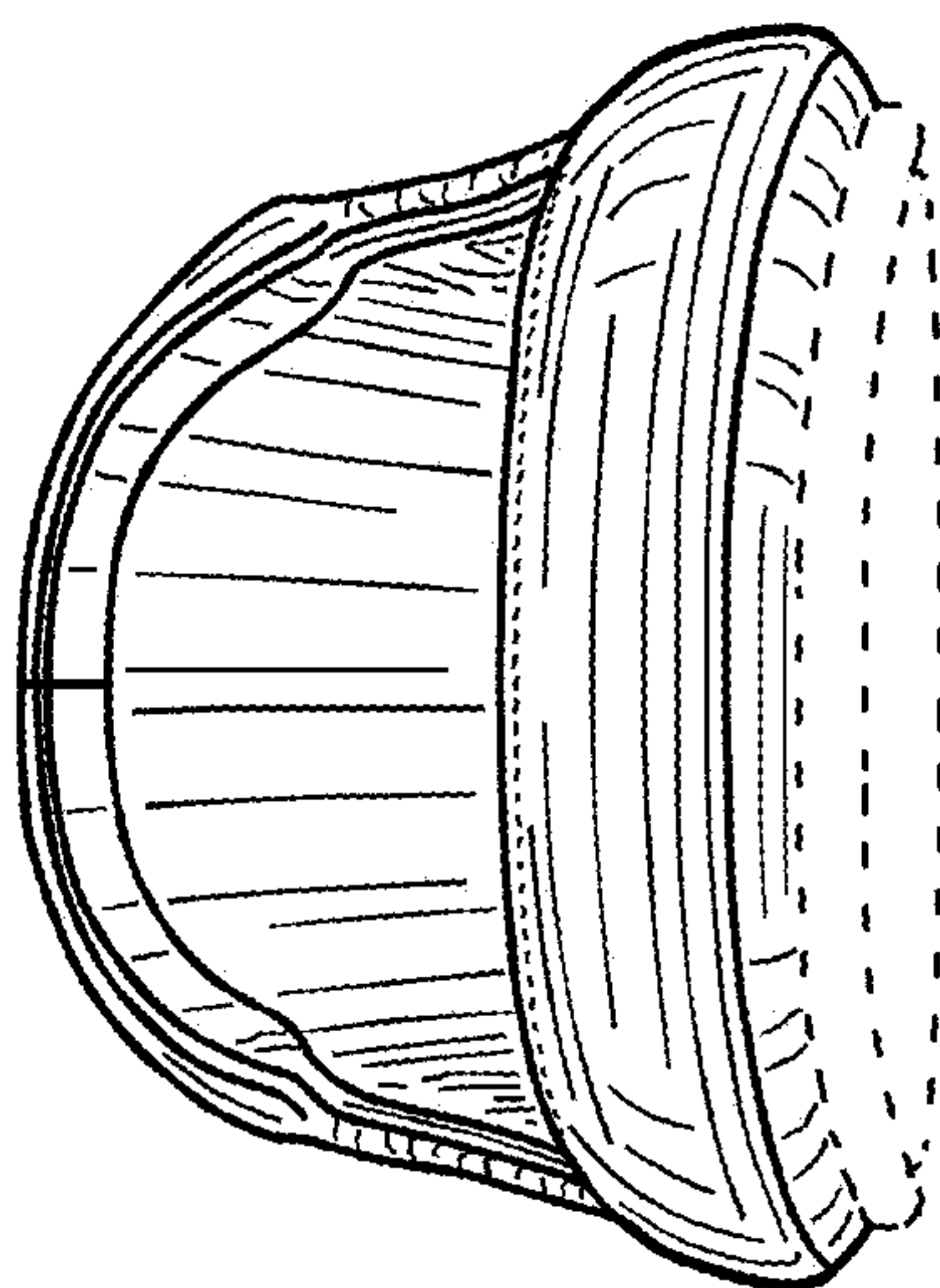

FIG. 27

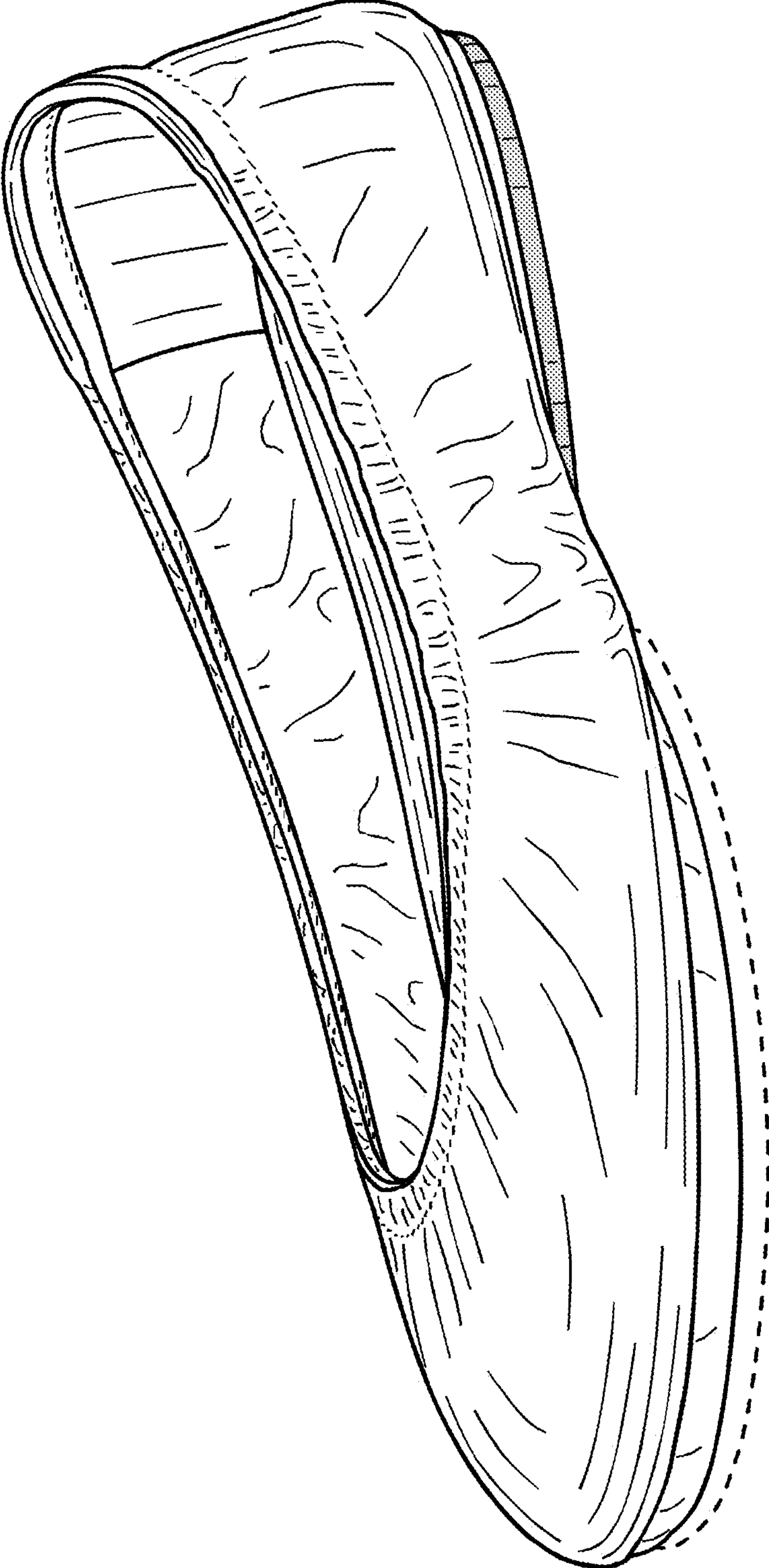

FIG. 29

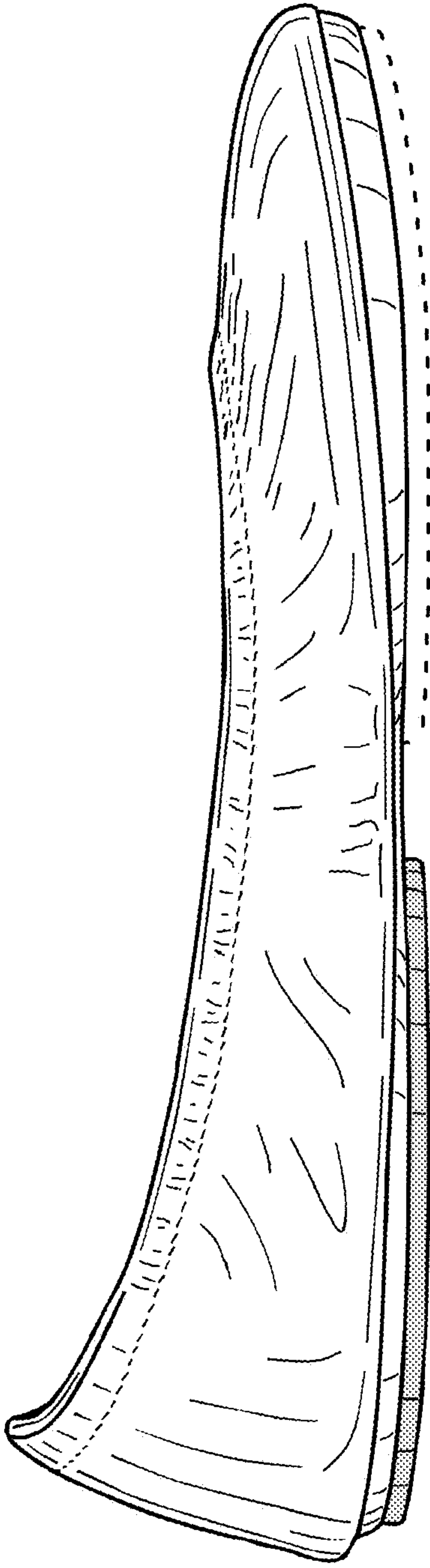

FIG. 30

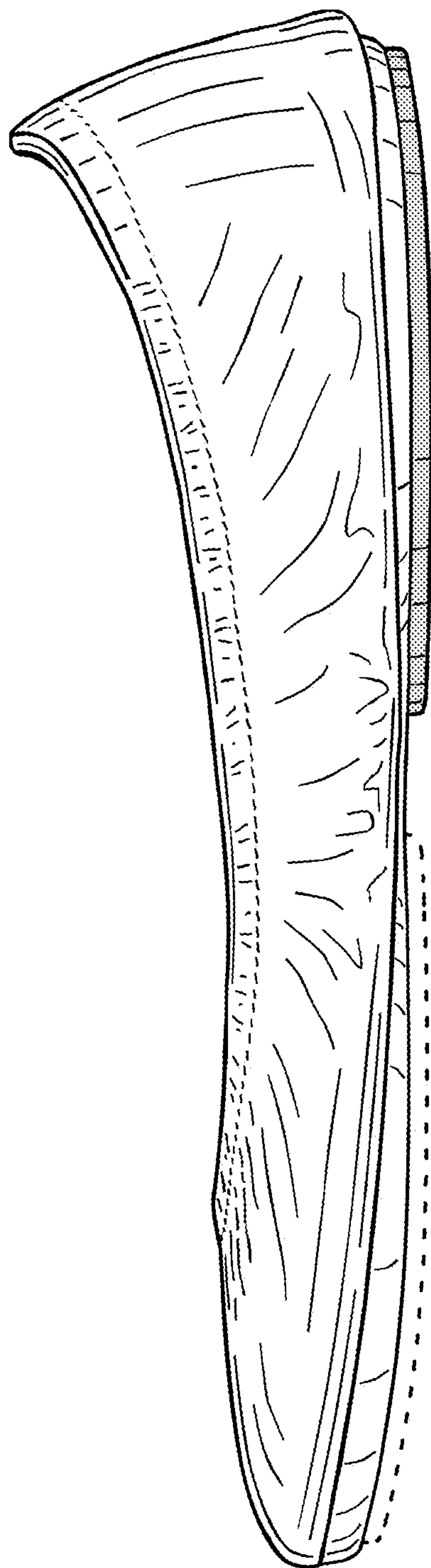

FIG. 31

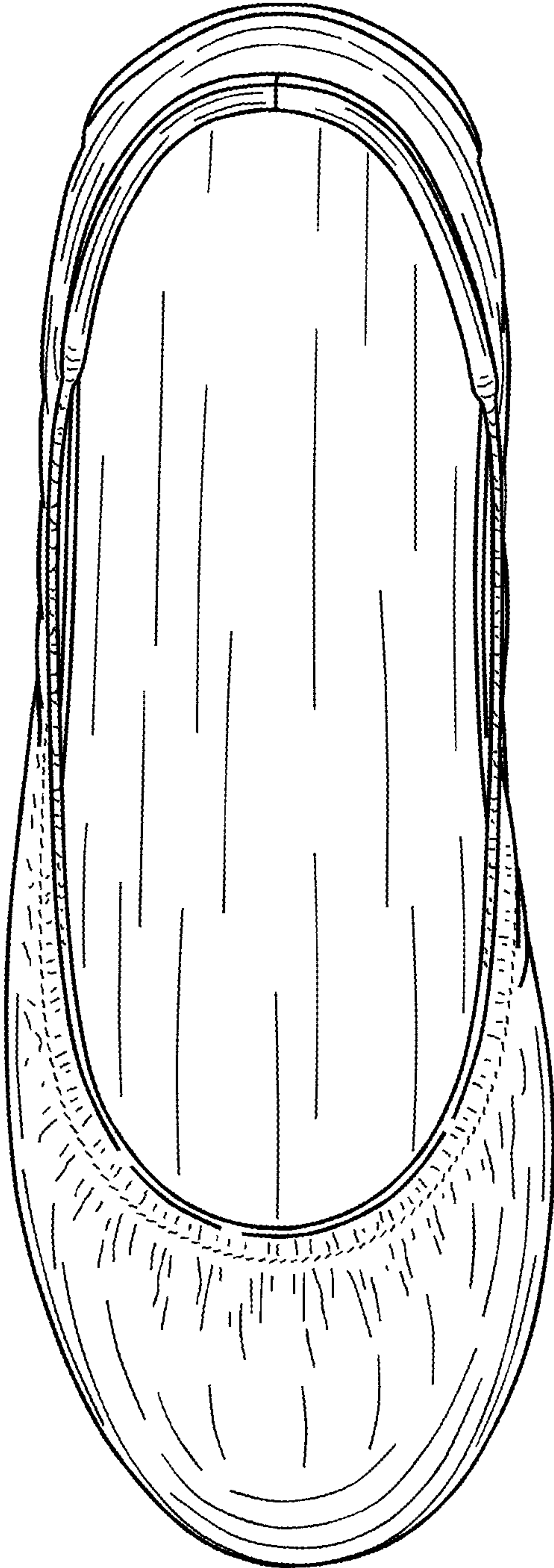

FIG. 32

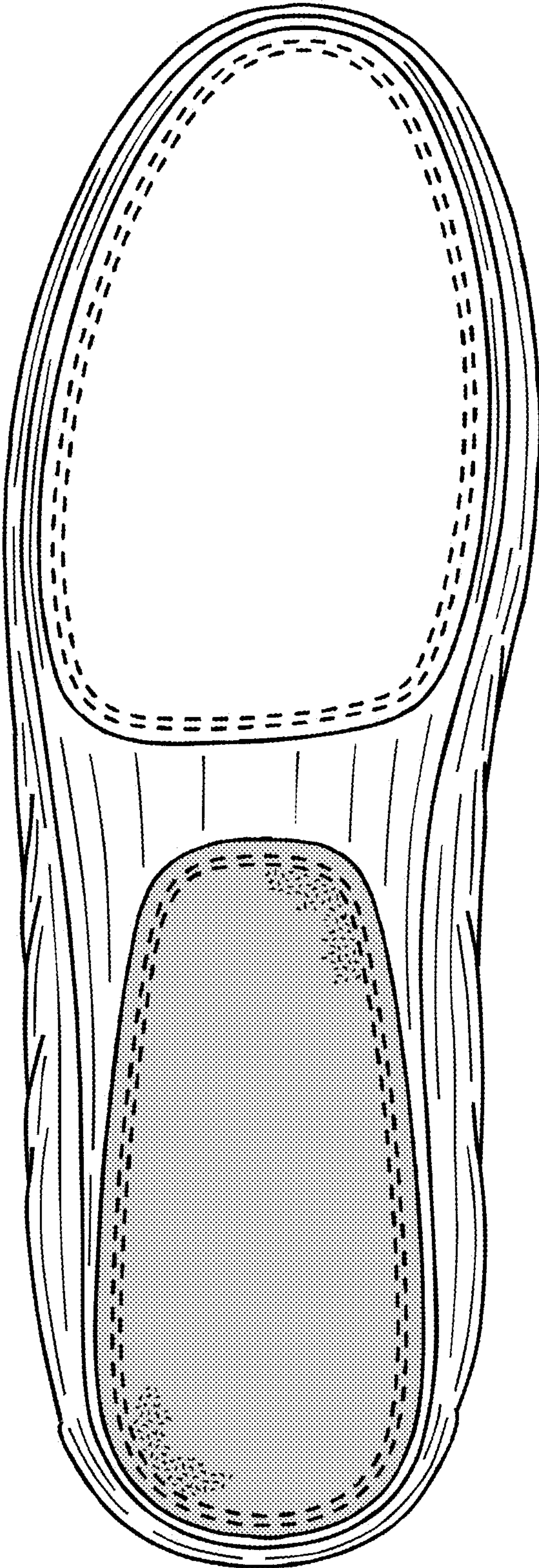

FIG. 33

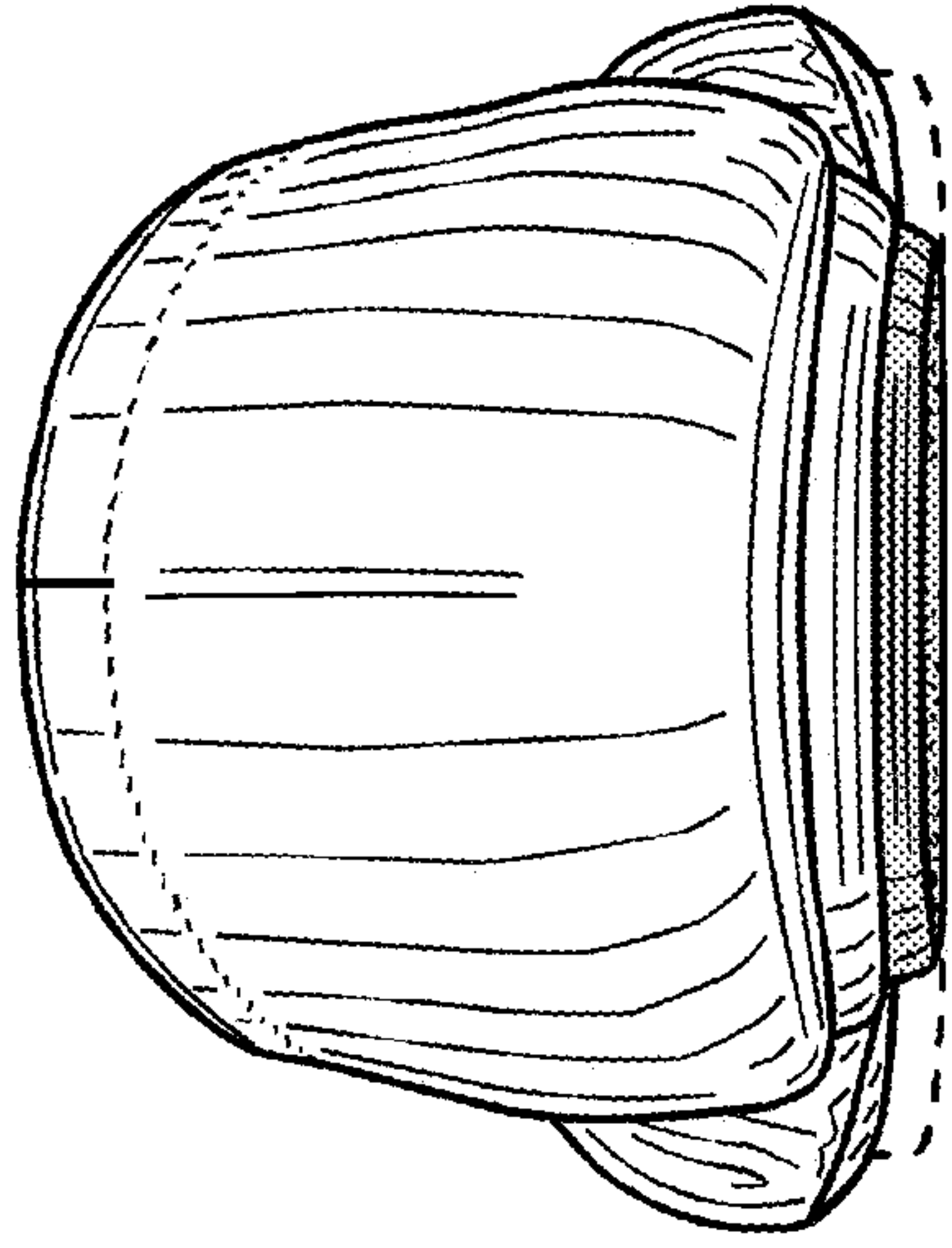

FIG. 35

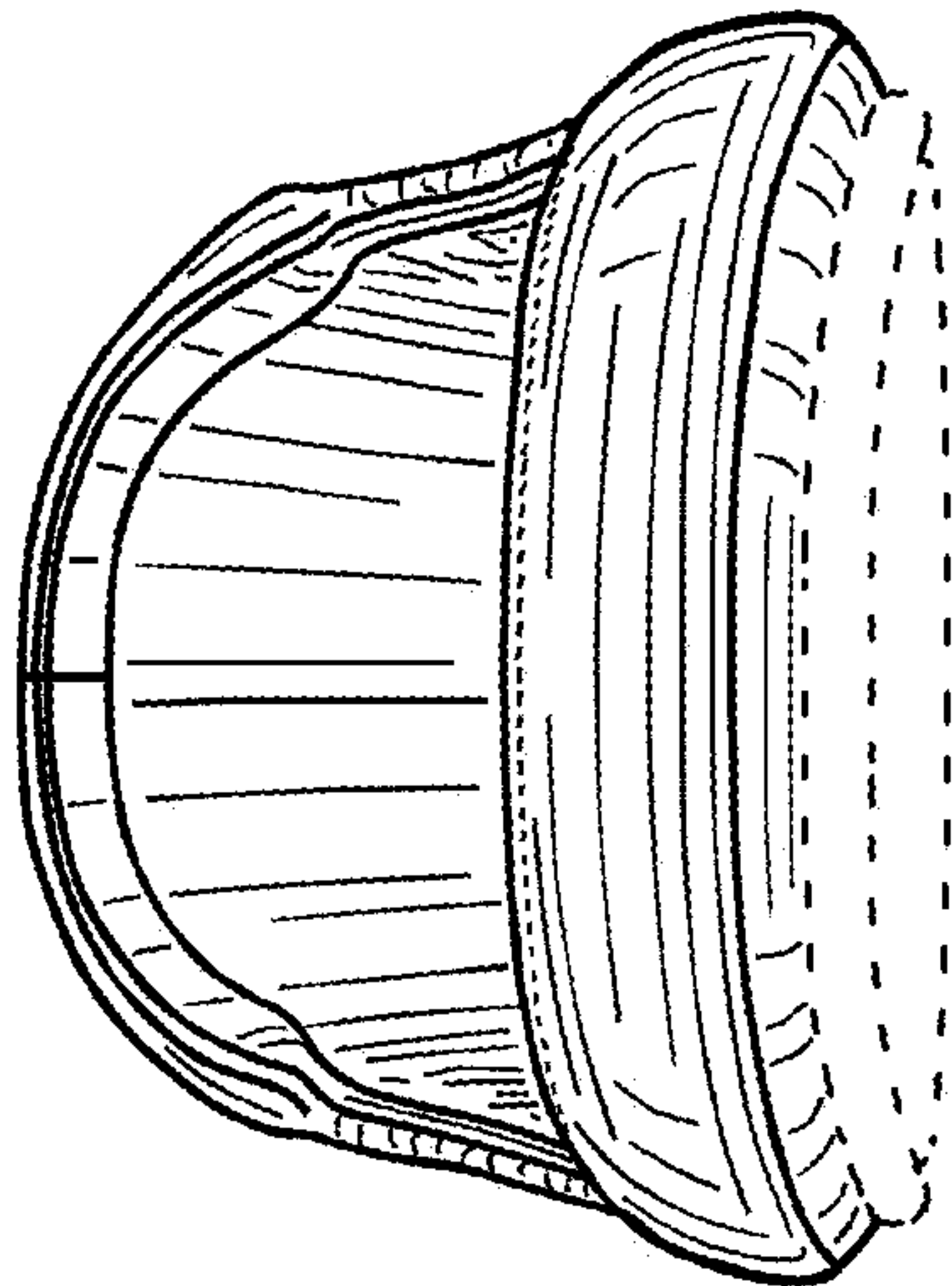

FIG. 34