



US00D967504S

(12) **United States Design Patent**  
**Geng**

(10) **Patent No.:** **US D967,504 S**  
(45) **Date of Patent:** **\*\* Oct. 18, 2022**

(54) **STARRY SKY PROJECTOR LAMP**  
(71) Applicant: **Shenzhen Yishengjie Technology Co., Ltd, Shenzhen (CN)**  
(72) Inventor: **Yi Geng, Shenzhen (CN)**  
(73) Assignee: **Shenzhen Yishengjie Technology Co., Ltd, Shenzhen (CN)**  
(\*\*) Term: **15 Years**

D840,582 S \* 2/2019 Liu ..... D26/104  
D900,377 S \* 10/2020 Chen ..... D26/106  
D908,932 S \* 1/2021 Richardson ..... D26/118  
D915,661 S \* 4/2021 Zhu ..... D26/106  
D917,092 S \* 4/2021 Zhang ..... D26/110  
D918,464 S \* 5/2021 Luo ..... D26/106  
D920,566 S \* 5/2021 Wei ..... D26/110  
D922,665 S \* 6/2021 Feng ..... D26/110  
D927,045 S \* 8/2021 Li ..... D26/110  
D946,815 S \* 3/2022 Zhou ..... D26/110  
D953,608 S \* 5/2022 Zheng ..... D26/104  
D957,035 S \* 7/2022 Tan ..... D26/93

(21) Appl. No.: **29/782,854**

\* cited by examiner

(22) Filed: **May 10, 2021**

*Primary Examiner* — Wan Laymon

*Assistant Examiner* — Clint A Samuel

(30) **Foreign Application Priority Data**

(74) *Attorney, Agent, or Firm* — Xuan Zhang

Apr. 21, 2021 (CN) ..... 202130228715.3

(51) **LOC (13) Cl.** ..... **26-05**

(52) **U.S. Cl.**  
USPC ..... **D26/110; D26/104**

(58) **Field of Classification Search**  
USPC .... D26/24, 40, 93, 102, 104, 106, 110, 118,  
D26/123, 124; D21/301, 443, 451, 452;  
D10/104.2, 114.1, 114.2, 114.5, 114.6,  
D10/114.8

CPC .. F21S 10/00; F21S 10/02; F21S 10/06; F21S  
10/005; F21S 10/063; F21S 9/00; F21W  
2121/008; F21W 2131/30; F21W  
2131/406

See application file for complete search history.

(56) **References Cited**

**U.S. PATENT DOCUMENTS**

D777,367 S \* 1/2017 Ma ..... D26/104  
D821,633 S \* 6/2018 Yang ..... D26/106

(57) **CLAIM**

The ornamental design for a starry sky projector lamp, as shown and described.

**DESCRIPTION**

FIG. 1 is a front perspective view of a starry sky projector lamp showing my new design;  
FIG. 2 is a front view thereof;  
FIG. 3 is a left view thereof;  
FIG. 4 is a right view thereof;  
FIG. 5 is a rear view thereof;  
FIG. 6 is a top view thereof;  
FIG. 7 is a bottom view thereof; and,  
FIG. 8 is a rear perspective view thereof.

The broken lines shown in the drawings are included for the purpose of illustrating portions of the starry sky projector lamp, and form no part of the claimed design.

**1 Claim, 8 Drawing Sheets**

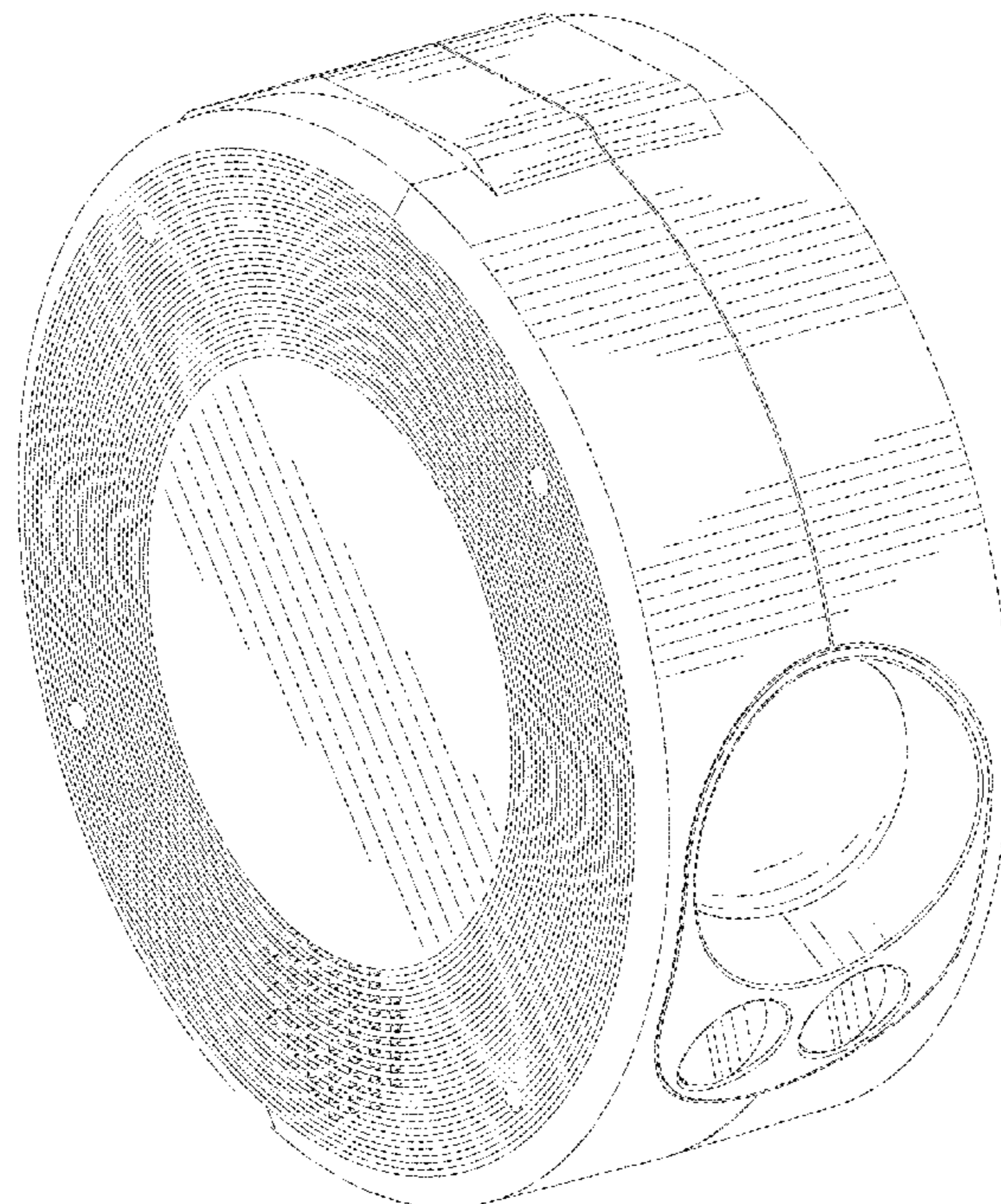

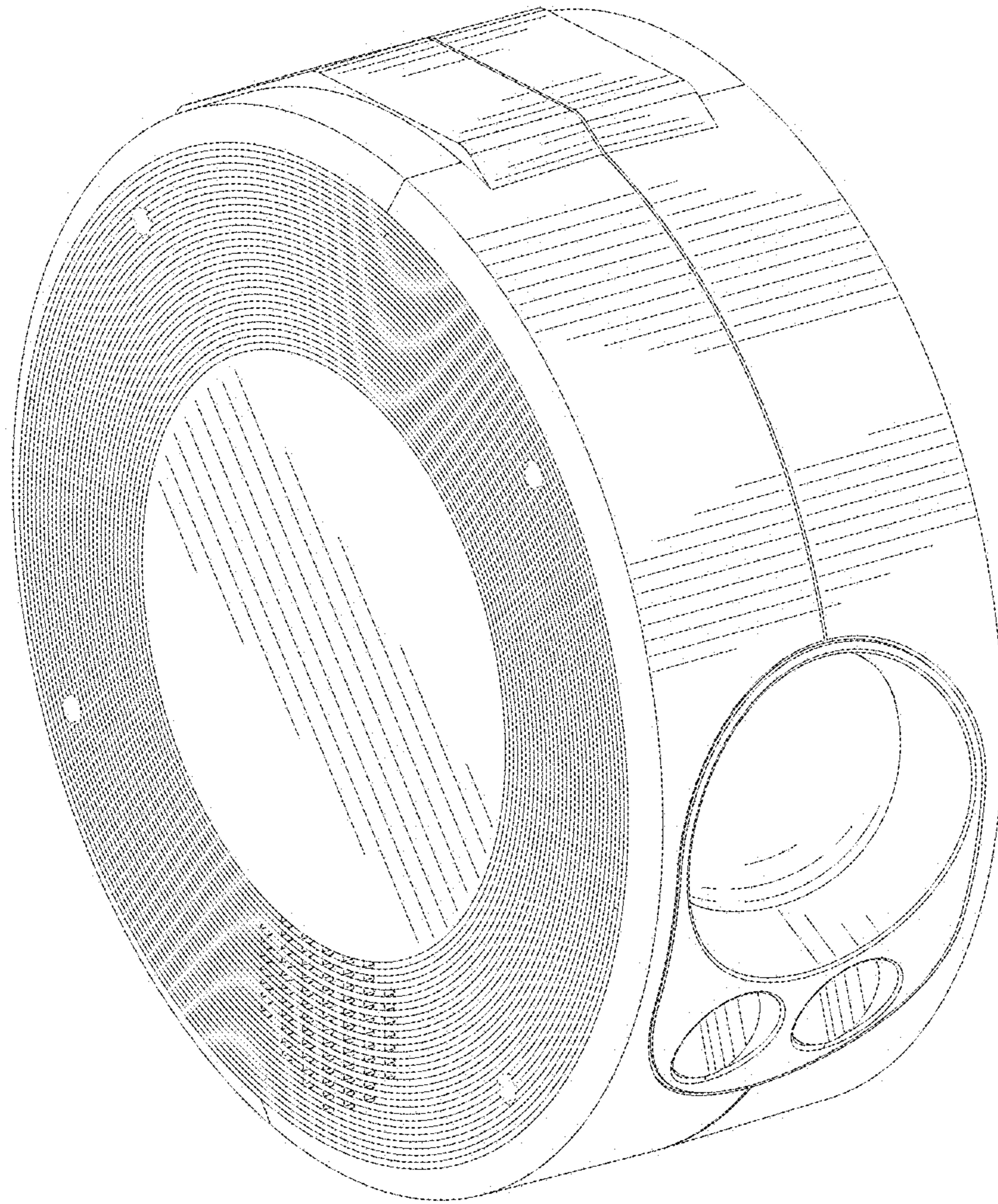

FIG. 1

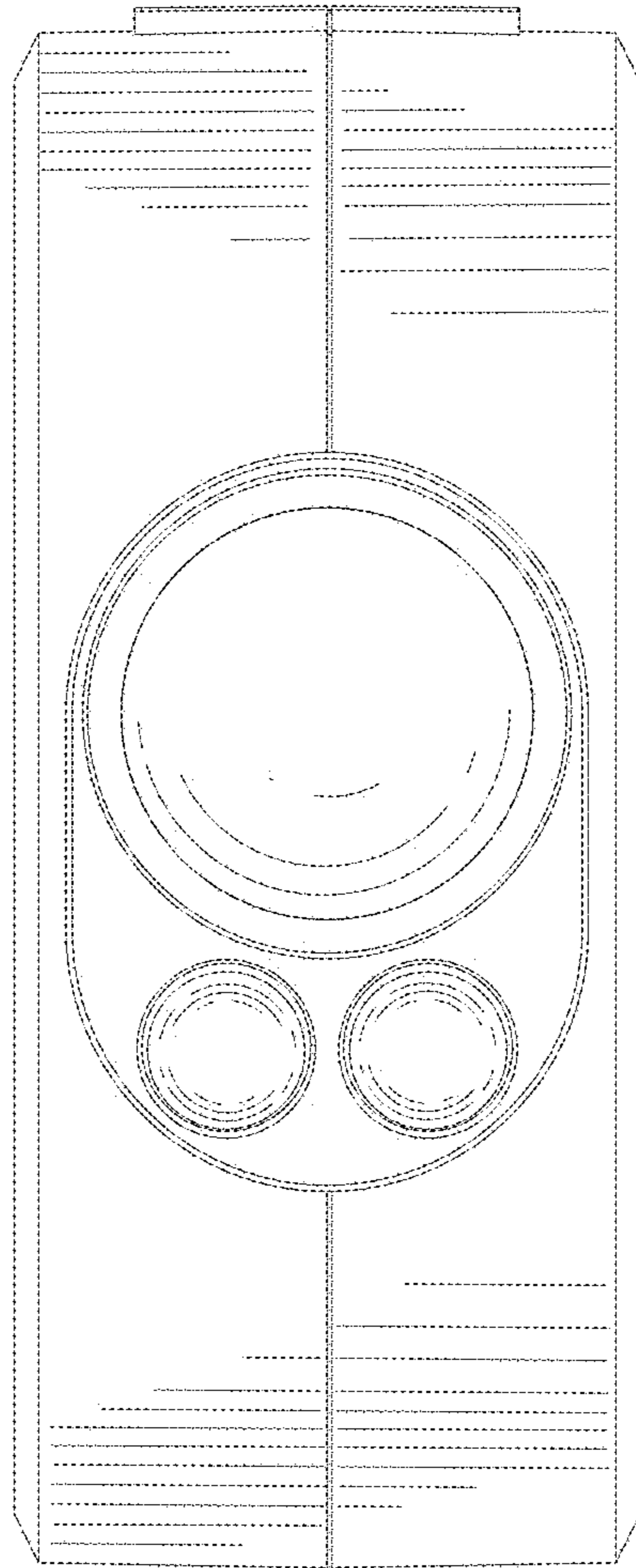

FIG. 2

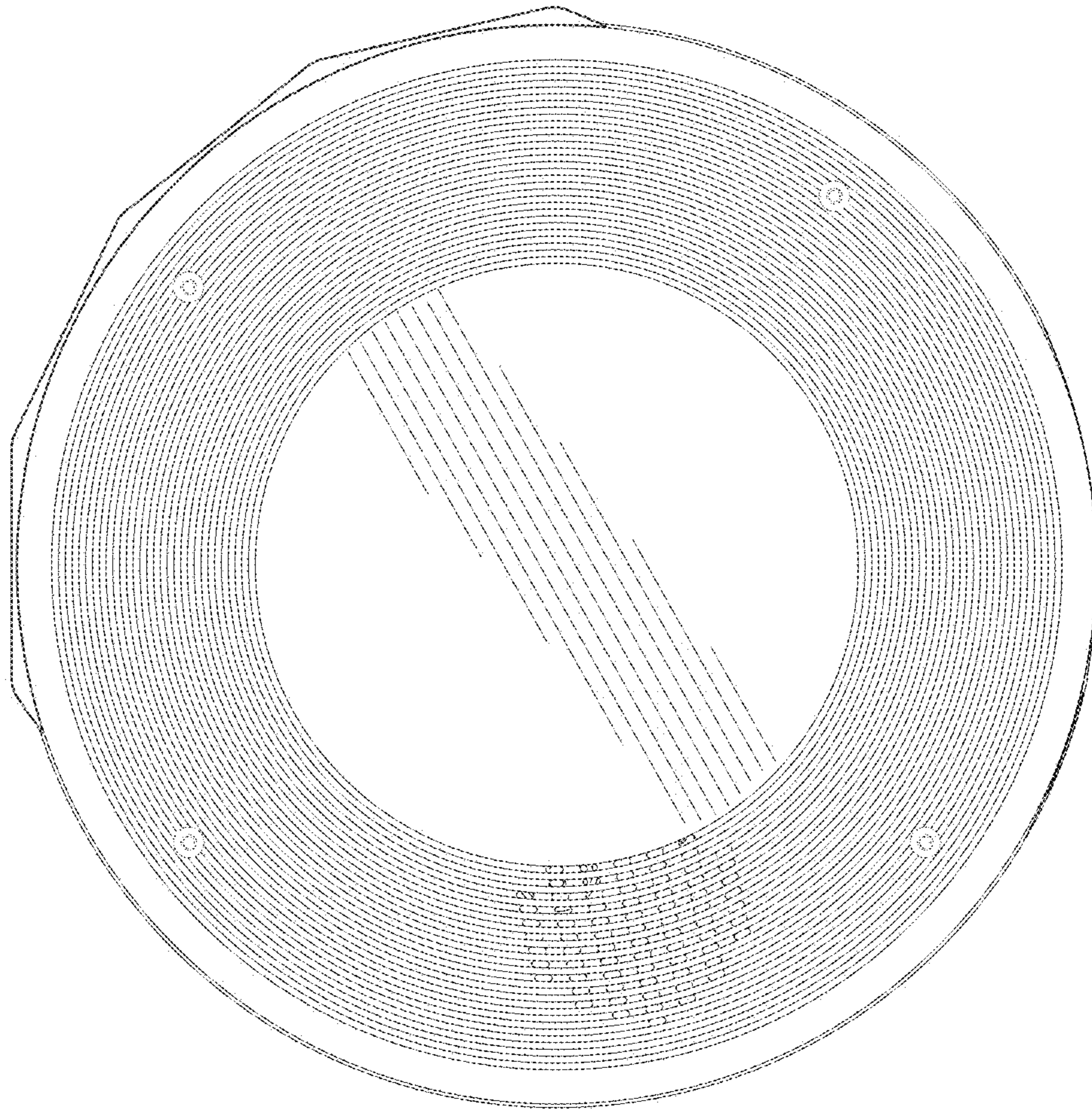

FIG. 3

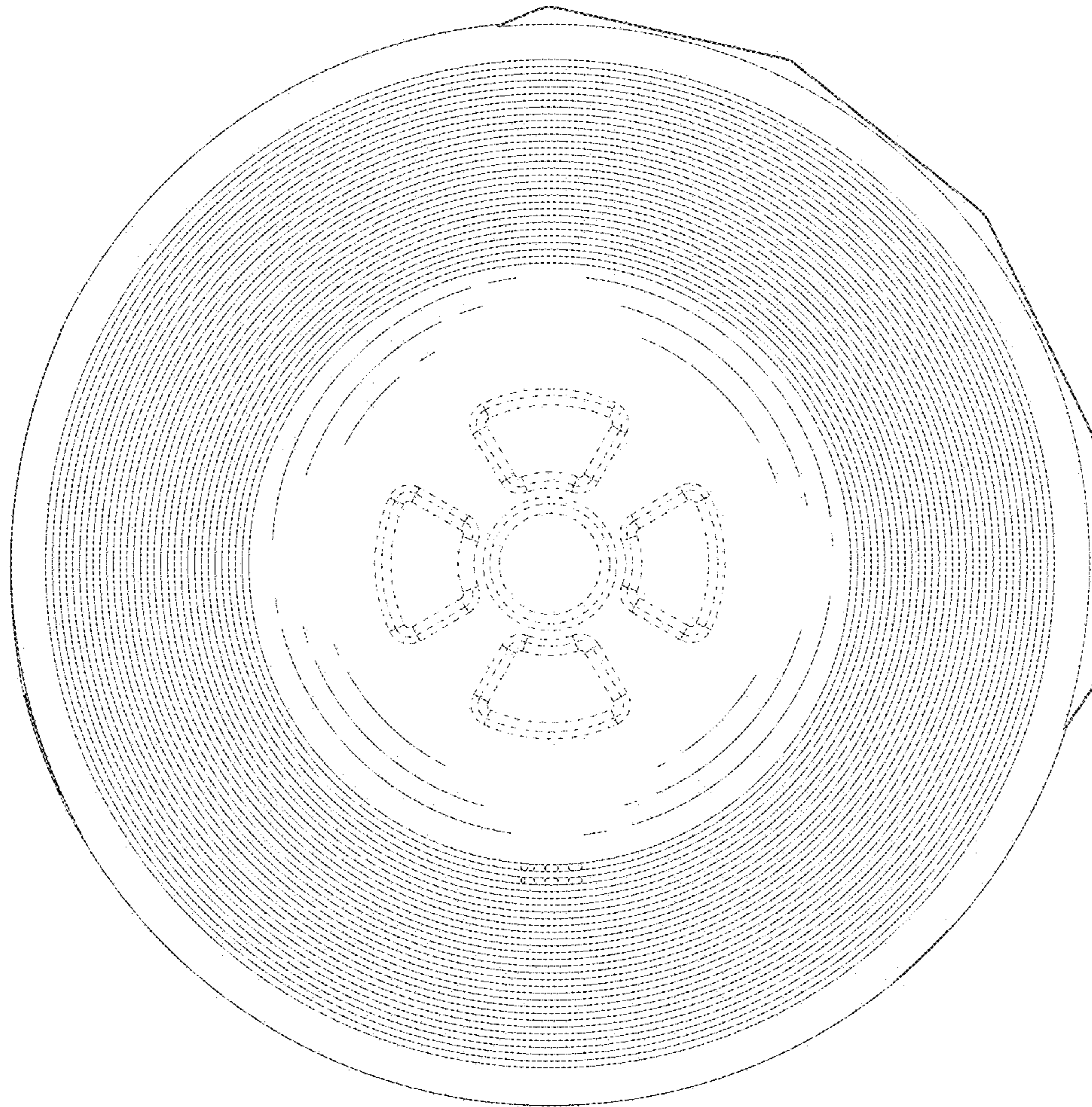

FIG. 4

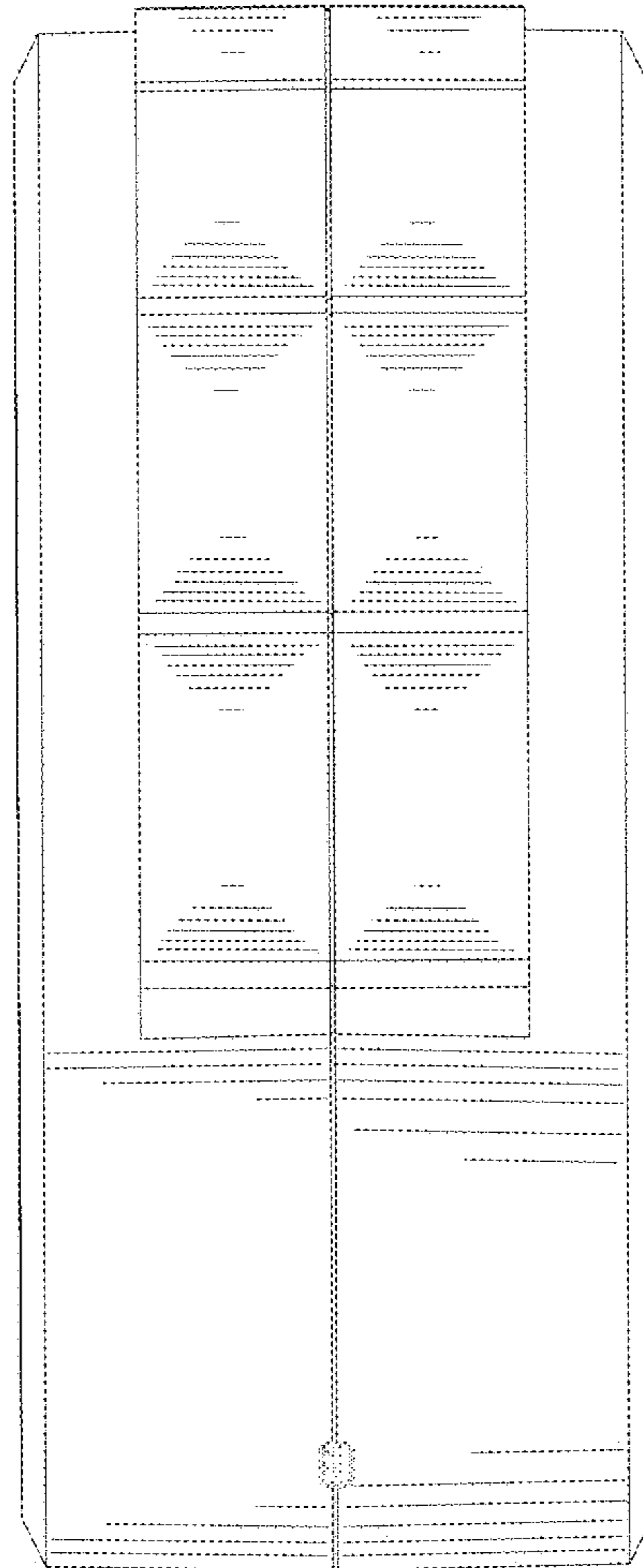

FIG. 5

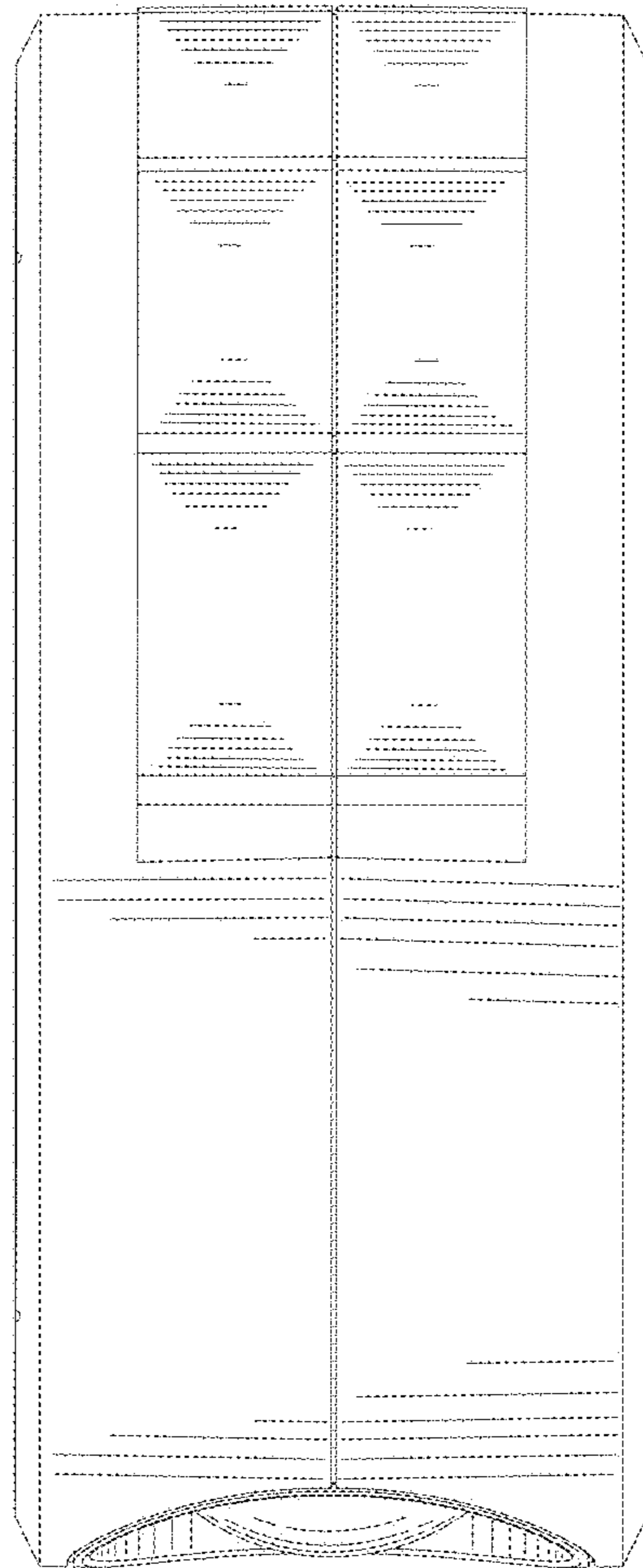

FIG. 6

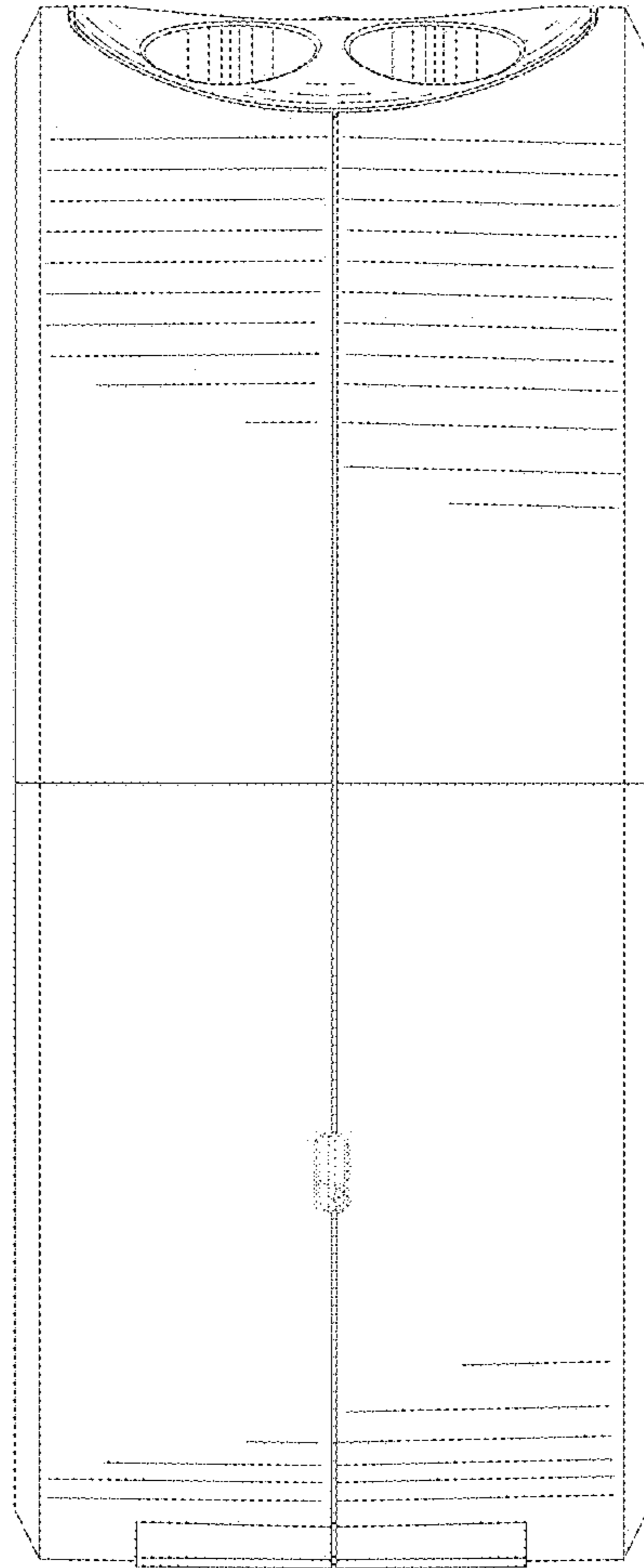

FIG. 7



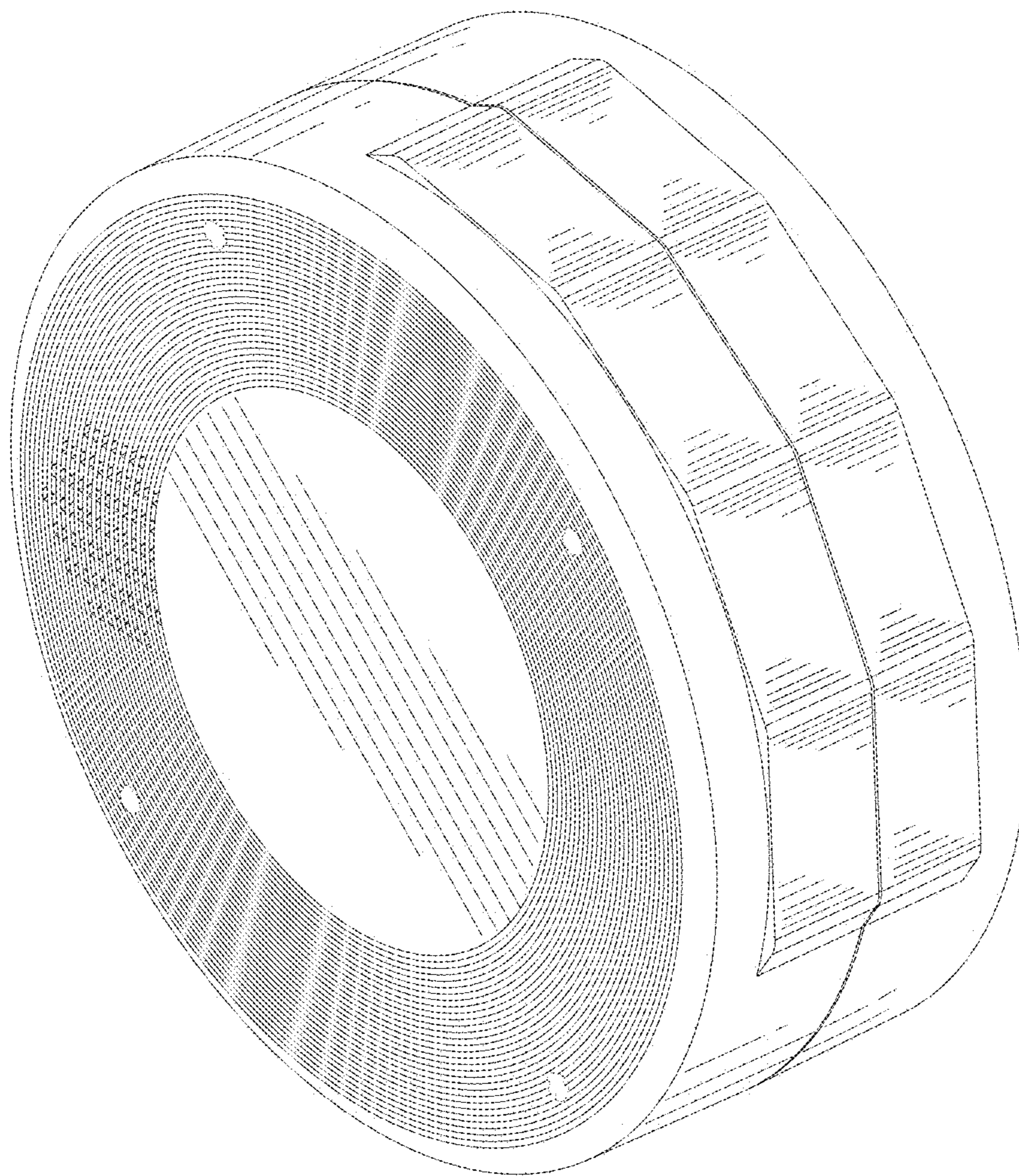

FIG. 8