

US00D967458S

(12) **United States Design Patent**
Palthur et al.

(10) **Patent No.:** **US D967,458 S**

(45) **Date of Patent:** **** Oct. 18, 2022**

(54) **KIOSK**

(71) Applicant: **INNONEO HEALTH TECHNOLOGIES, INC.**, Boston, MA (US)

(72) Inventors: **Maruthi Prasad Palthur**, Westborough, MA (US); **Mary Elizabathe Joseph**, Hopkinton, MA (US)

(73) Assignee: **INNONEO HEALTH TECHNOLOGIES, INC.**, Boston, MA (US)

(**) Term: **15 Years**

(21) Appl. No.: **29/751,839**

(22) Filed: **Sep. 23, 2020**

(51) **LOC (13) Cl.** **25-03**

(52) **U.S. Cl.**
USPC **D25/33**

(58) **Field of Classification Search**
USPC D25/1-35, 48.1

(Continued)

(56) **References Cited**

U.S. PATENT DOCUMENTS

2,090,827 A * 8/1937 Bak E04H 1/1222
126/190
2,707,426 A * 5/1955 Cooper E04B 1/24
52/270

(Continued)

FOREIGN PATENT DOCUMENTS

CN 201430016890 * 8/2014
CN 201730415458 * 4/2018
CN 201730438588 * 4/2018

OTHER PUBLICATIONS

Isolation Rooms, available in tgh.org, announced Year 2020 [online], [site visited Feb. 25, 2022], Internet URL: <https://www.tgh.org/>

news/tgh-health-news/2020/may/how-isolation-rooms-help-keep-patients-safe (Year: 2020).*

(Continued)

Primary Examiner — Brett Miller
Assistant Examiner — Jasmine L. Comedy

(57) **CLAIM**

The ornamental design for a kiosk, as shown and described.

DESCRIPTION

FIG. 1 is a front-top perspective view of a kiosk showing my new design;
FIG. 2 is a front-bottom perspective view thereof;
FIG. 3 is a rear-top perspective view thereof;
FIG. 4 is a rear-bottom perspective view thereof;
FIG. 5 is a rear elevational view thereof;
FIG. 6 is a front elevational view thereof;
FIG. 7 is a left elevational view thereof;
FIG. 8 is a right elevational view thereof;
FIG. 9 is a top plan view thereof;
FIG. 10 is a bottom plan view thereof;
FIG. 11 is a left cross-sectional view taken along cutting line 11-11 in FIG. 9;
FIG. 12 is a front-top perspective cross-sectional view taken along cutting line 11-11 in FIG. 9;
FIG. 13 is a rear-top perspective cross-sectional view taken along cutting line 11-11 in FIG. 9;
FIG. 14 is a left cross-sectional view taken along cutting line 14-14 in FIG. 9;
FIG. 15 is a front-top perspective cross-sectional view taken along cutting line 14-14 in FIG. 9;
FIG. 16 is a rear-top perspective cross-sectional view taken along cutting line 14-14 in FIG. 9; and,
FIG. 17 is a supplemental front-top perspective view of the kiosk with a logo.
The broken lines shown are for illustrative purposes only and form no part of the claimed design.

1 Claim, 17 Drawing Sheets

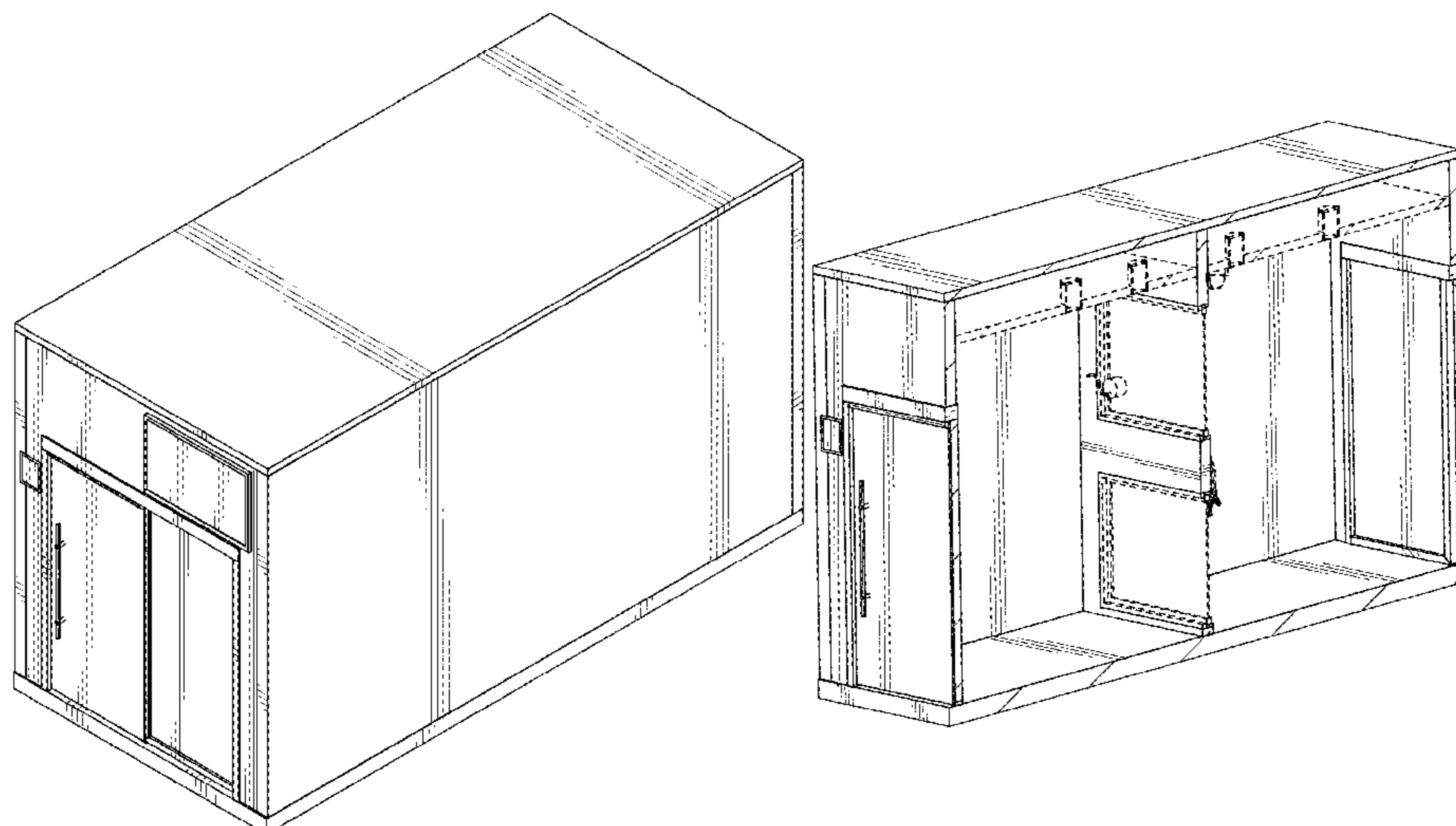

(58) **Field of Classification Search**

CPC ... E04H 1/1222; E04H 1/1272; E04H 12/182;
E04H 1/1205; E04H 1/125; E04H 3/08;
E04B 1/24

See application file for complete search history.

D828,927	S	*	9/2018	Solie	D25/33
D829,343	S	*	9/2018	Solie	D25/33
D846,147	S	*	4/2019	Zhu	D25/16
10,376,604	B2		8/2019	Romo et al.		
D885,812	S	*	6/2020	Kahn	D6/700
2014/0251401	A1	*	9/2014	Barber	E04H 1/1205 135/121
2015/0199783	A1		7/2015	Cashman et al.		

(56) **References Cited**

U.S. PATENT DOCUMENTS

3,110,907	A	*	11/1963	King	E04B 1/34869 4/300
3,383,812	A	*	5/1968	Starr	E04H 1/1205 52/36.2
3,611,907	A	*	10/1971	Wasserman	E04B 1/8218 D25/16
D344,140	S	*	2/1994	Webster	D25/33
5,285,604	A	*	2/1994	Carlin	E04H 1/1205 52/36.2
D655,019	S	*	2/2012	Colless	D25/15
D694,909	S		12/2013	Cashman et al.		
9,103,134	B1	*	8/2015	Murray	E04H 1/125
D745,188	S	*	12/2015	Hart	D25/16
D771,835	S	*	11/2016	Bottin	D25/33
D791,967	S	*	7/2017	Goldberg	D25/16
D812,247	S	*	3/2018	Price	D25/16

OTHER PUBLICATIONS

Critical Isolation Rooms, available in starcsystems.com, announced Year 2020 [online], [site visited Feb. 25, 2022], Internet URL: <https://blog.starcsystems.com/blog/starc-systems-refocuses-production-to-provide-critical-isolation-rooms-for-healthcare-facilities> (Year: 2020).*

Shim Hyun-Tai, Korea's evolving virus tests—from drive-through to walk-through, <<http://www.koreabiomed.com/news/articleView.html?idxno=7767>>.

The 'phone booths' that are making Covid tests in India easier, quicker and safer, <<https://economictimes.indiatimes.com/industry/healthcare/biotech/healthcare/the-phone-booths-that-are-making-covid-tests-in-india-easier-quicker-and-safer/articleshow/75040280.cms?from=mdr>>.

* cited by examiner

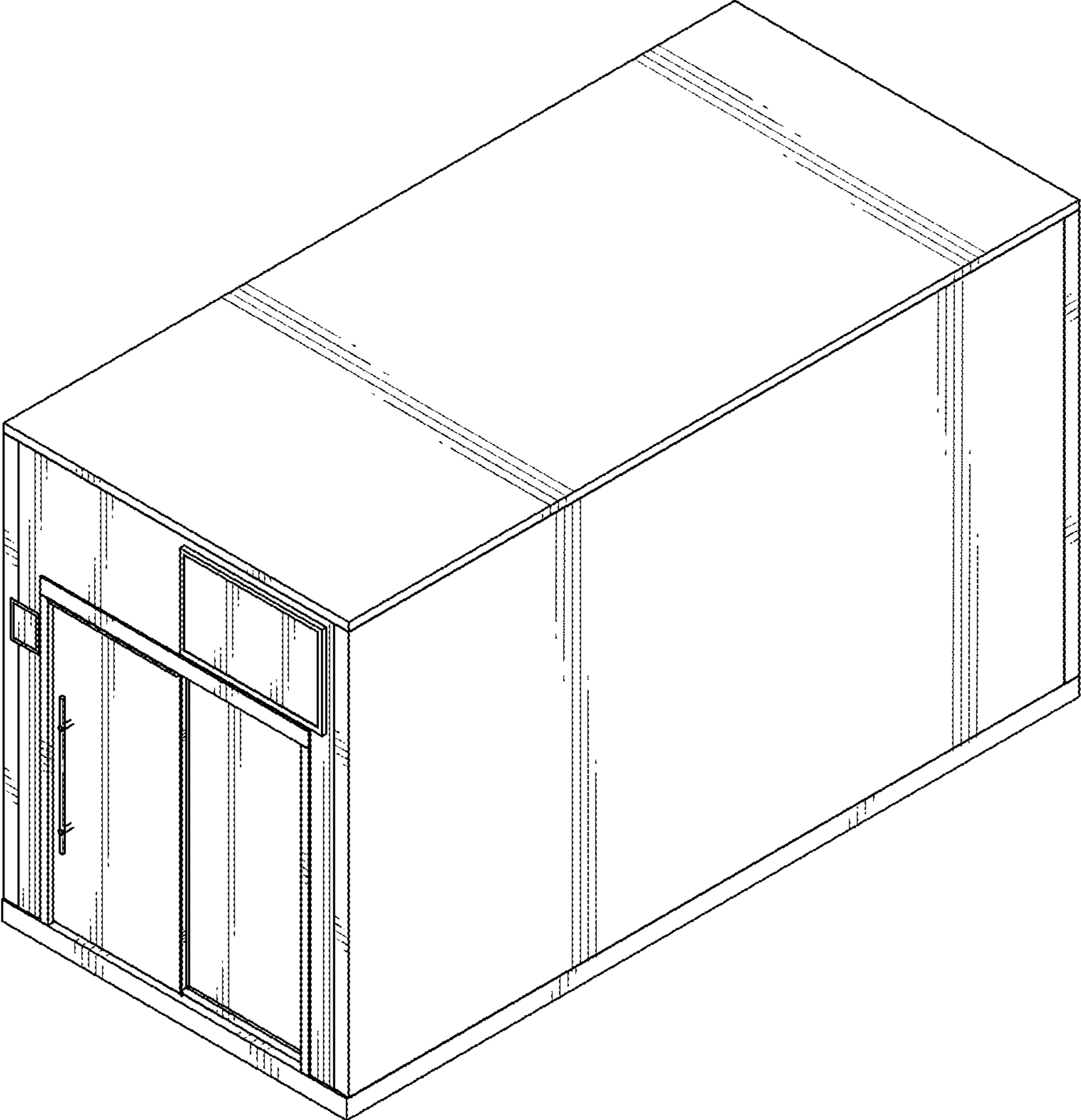

FIG. 1

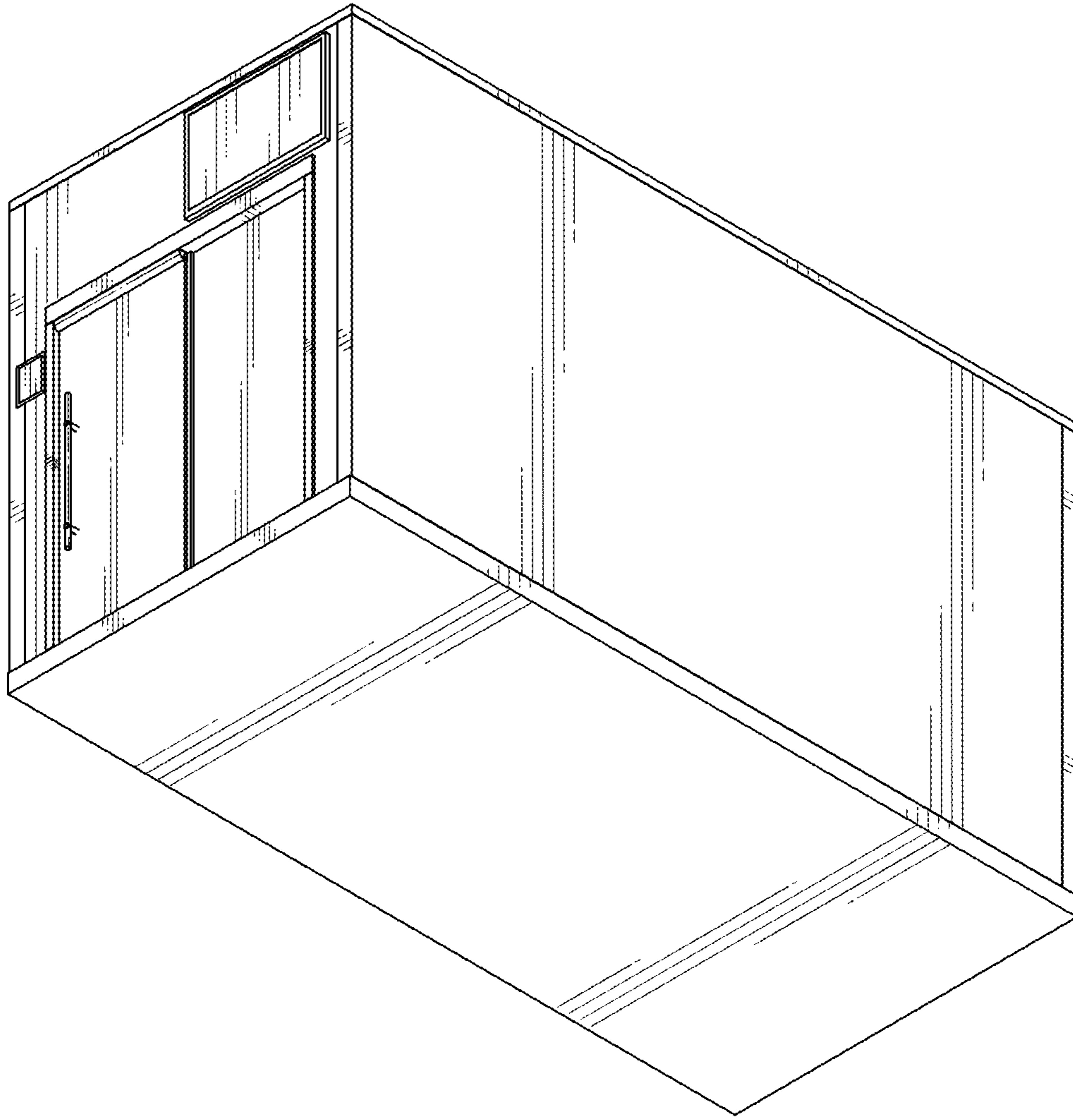

FIG. 2

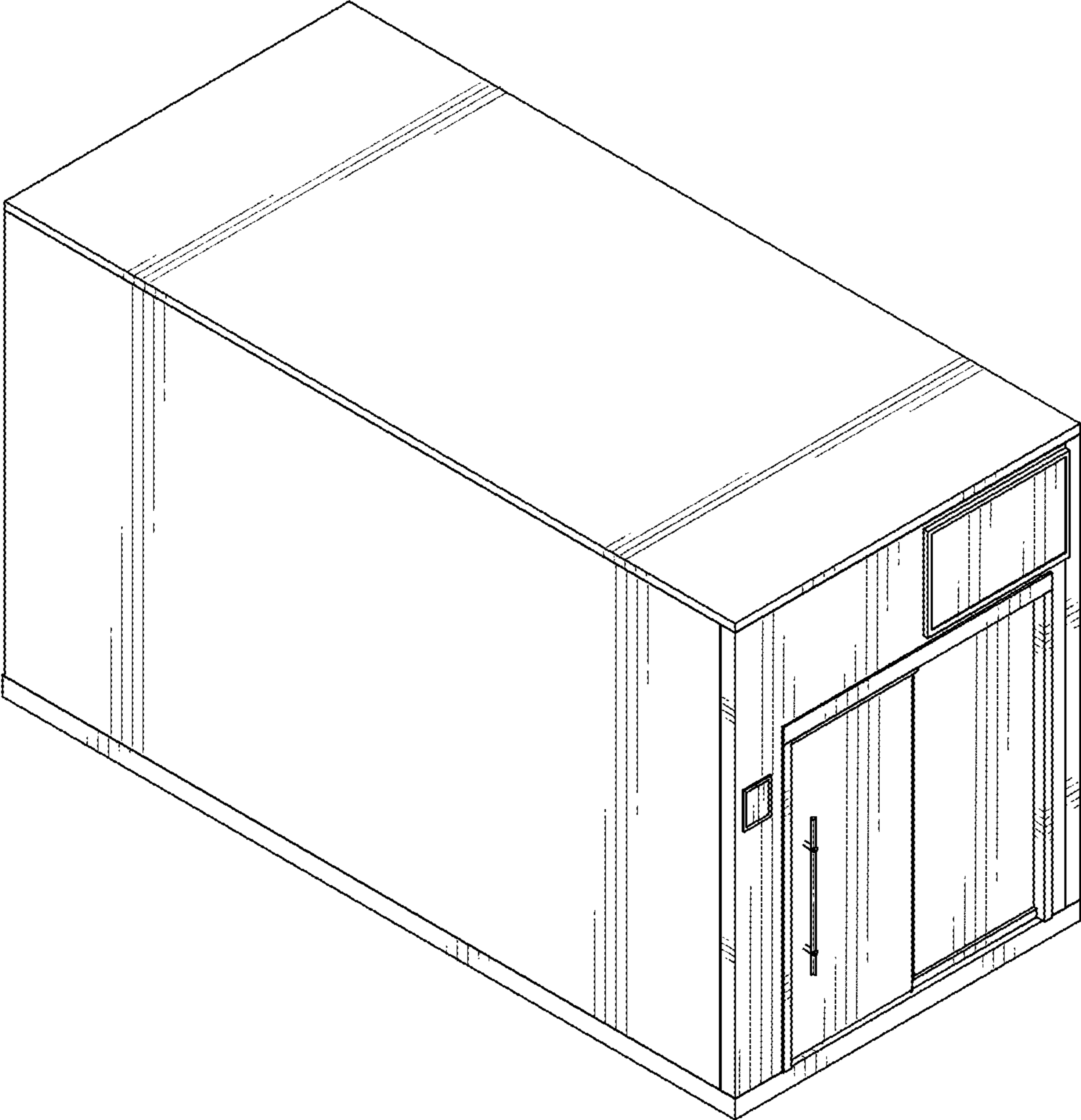

FIG. 3

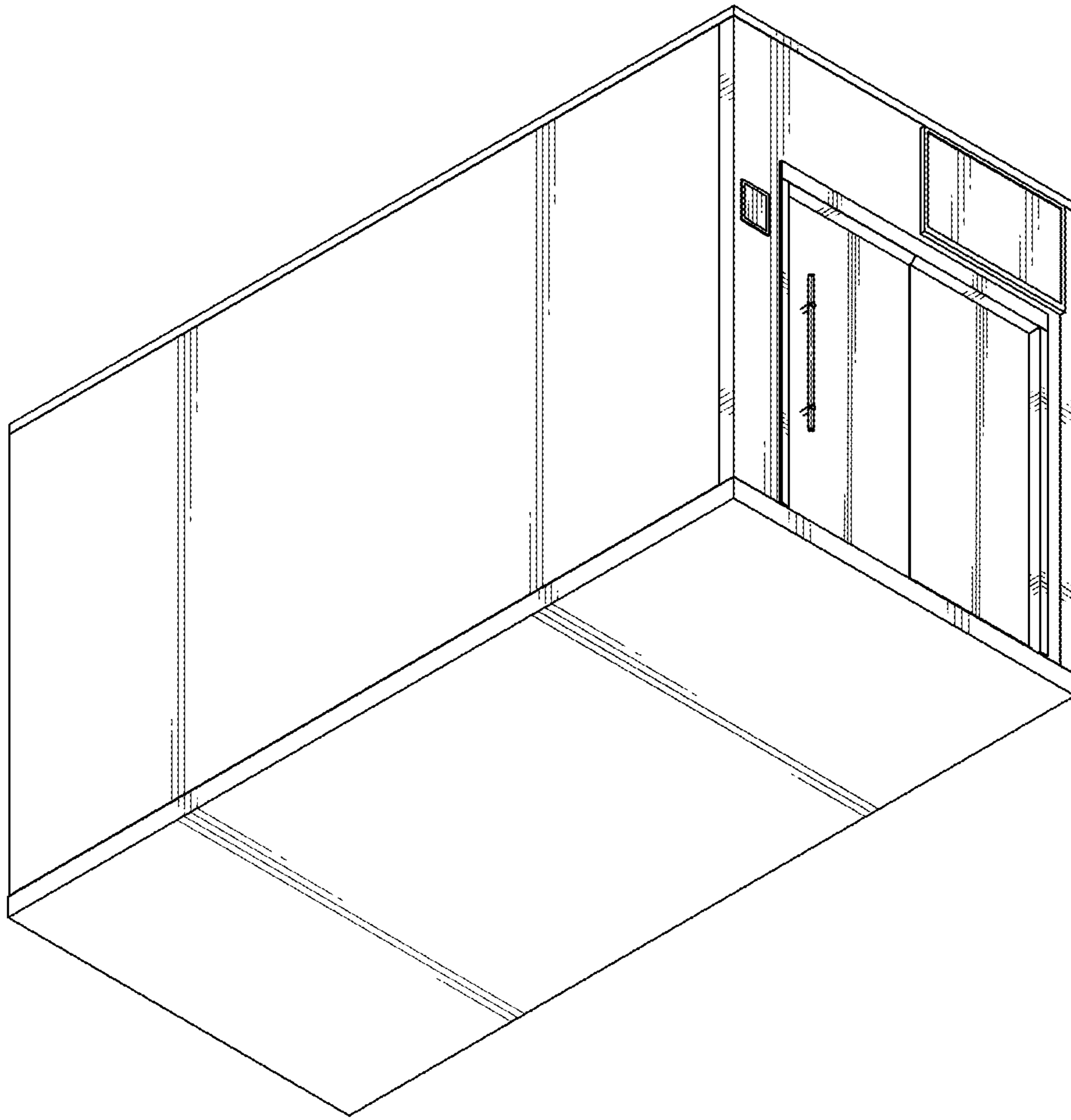

FIG. 4

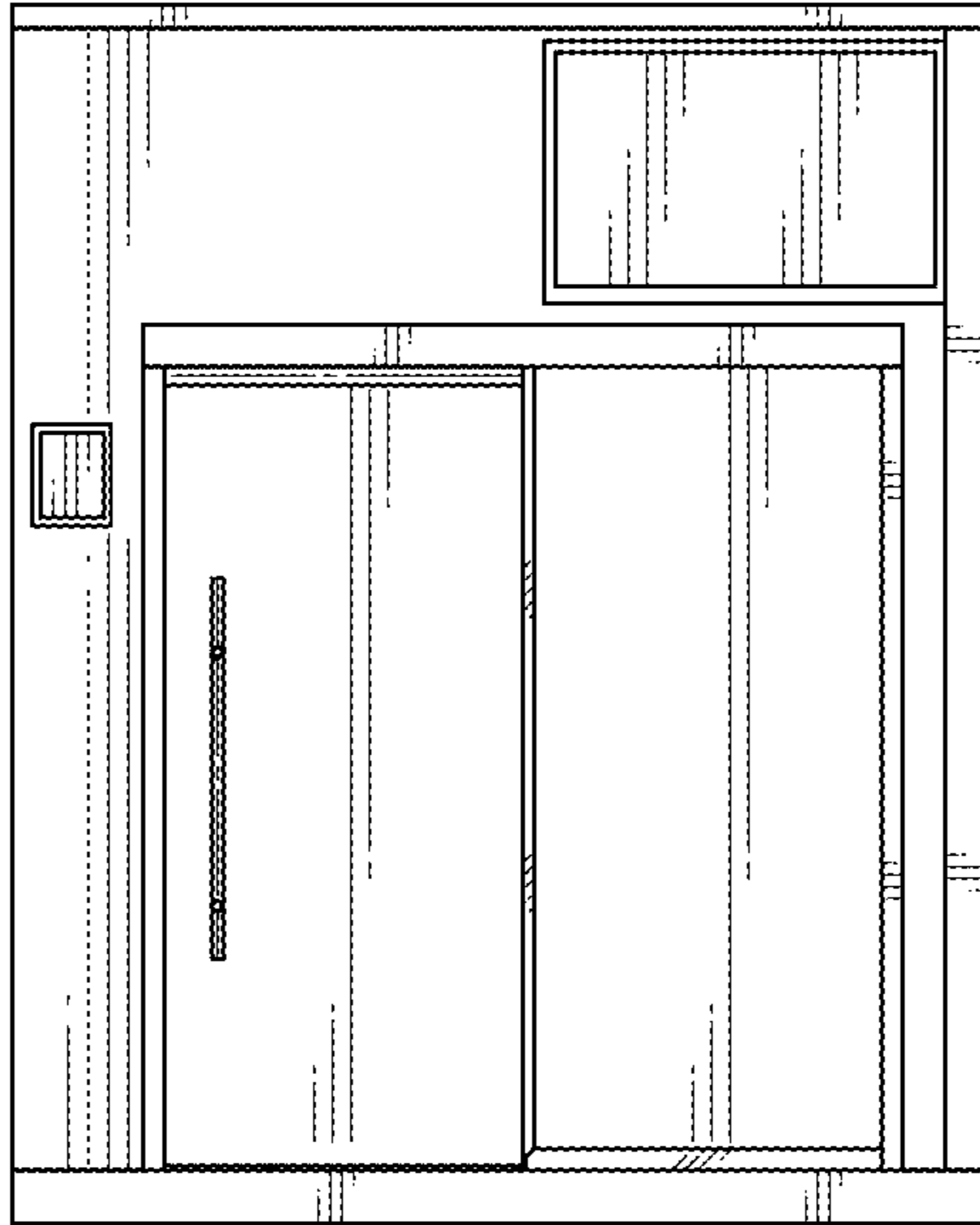

FIG. 5

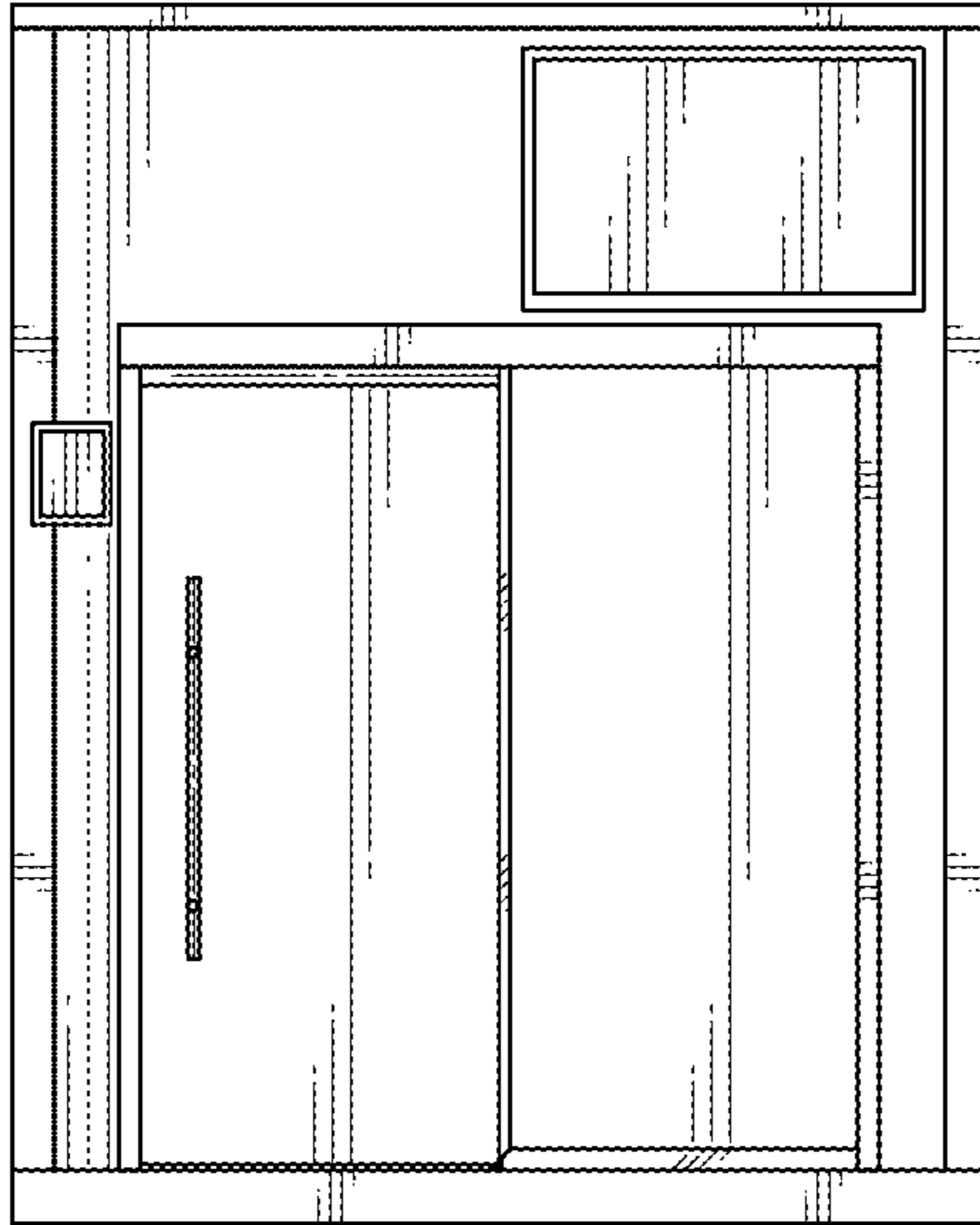

FIG. 6

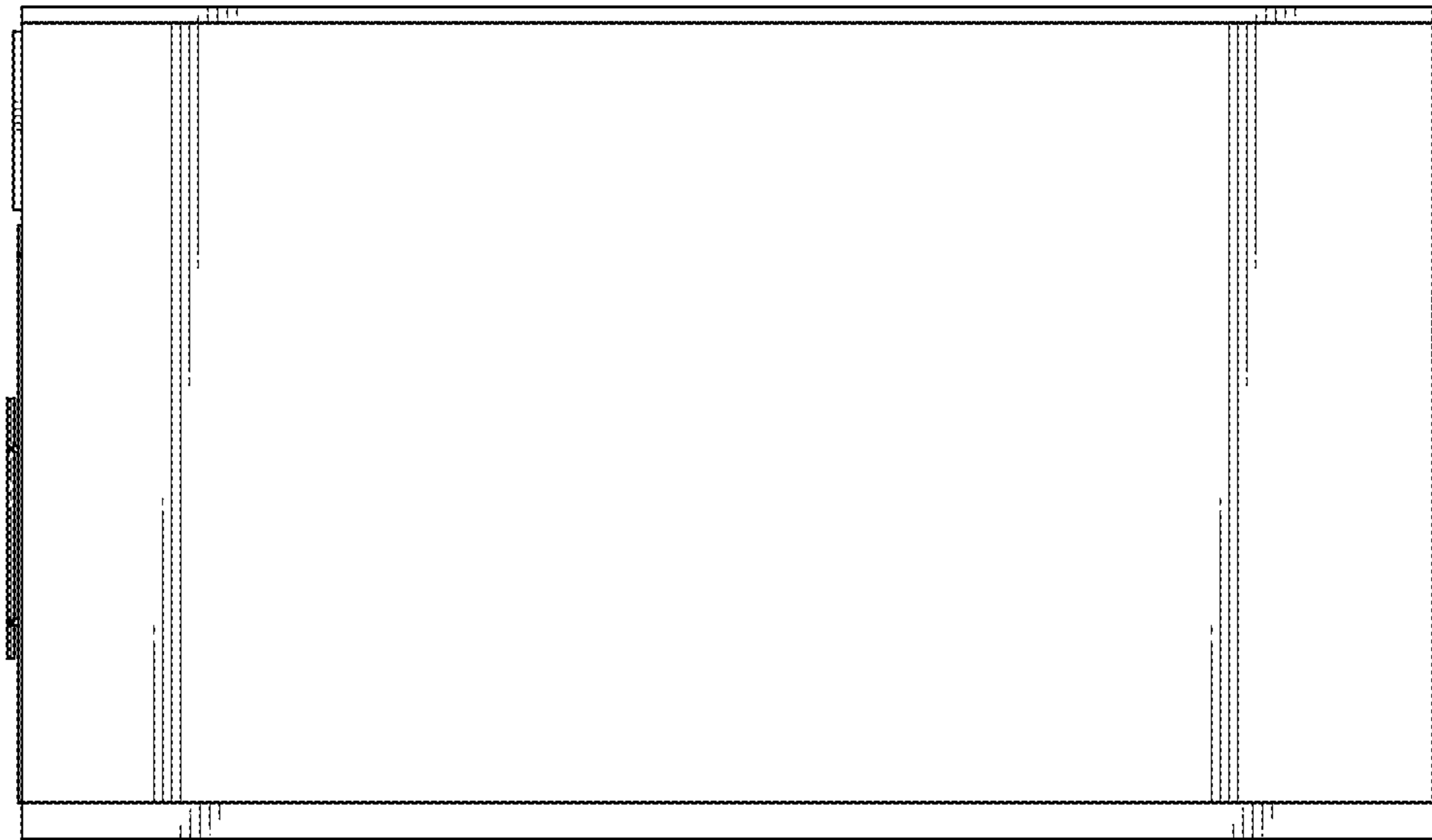

FIG. 7

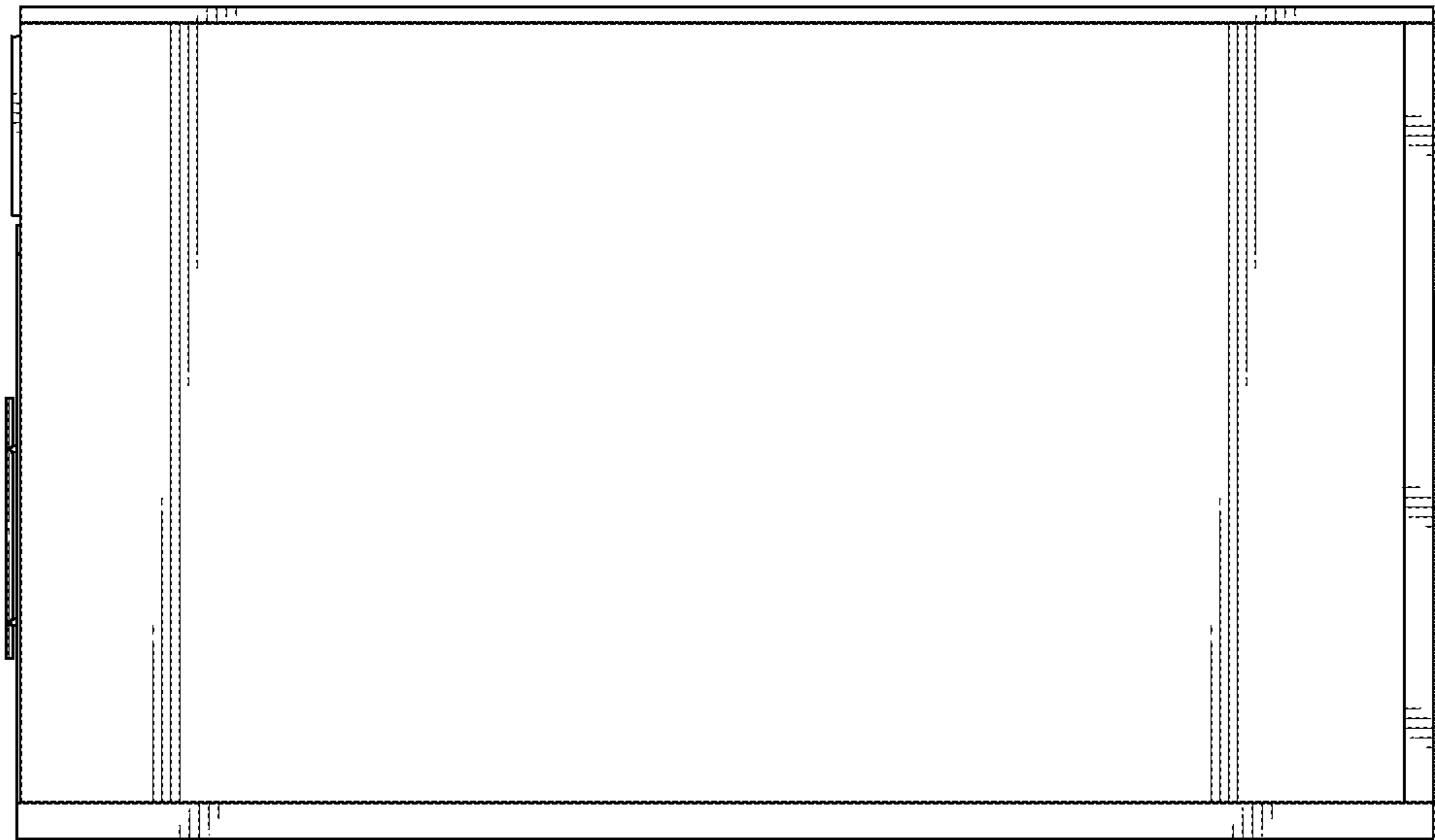

FIG. 8

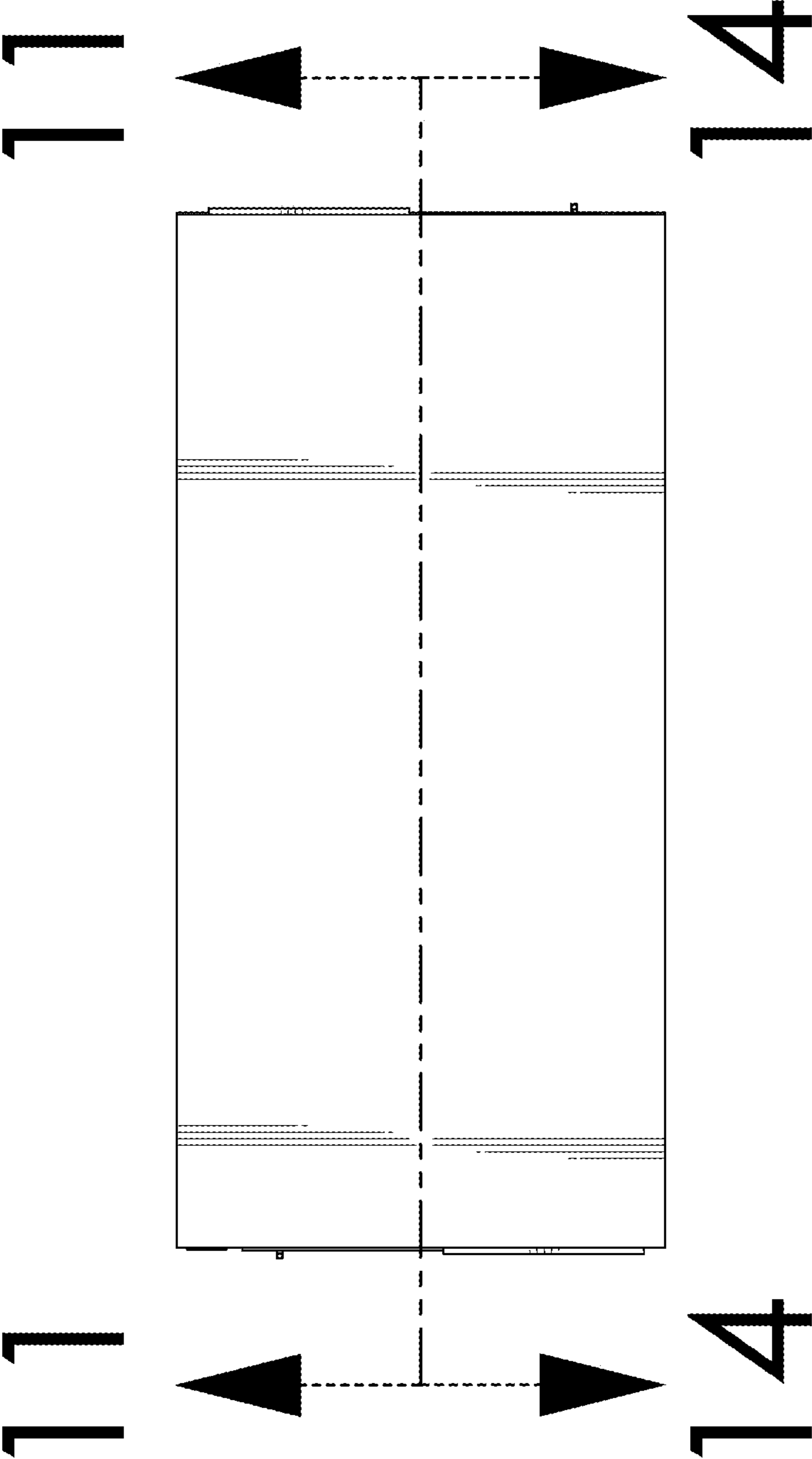

FIG. 9

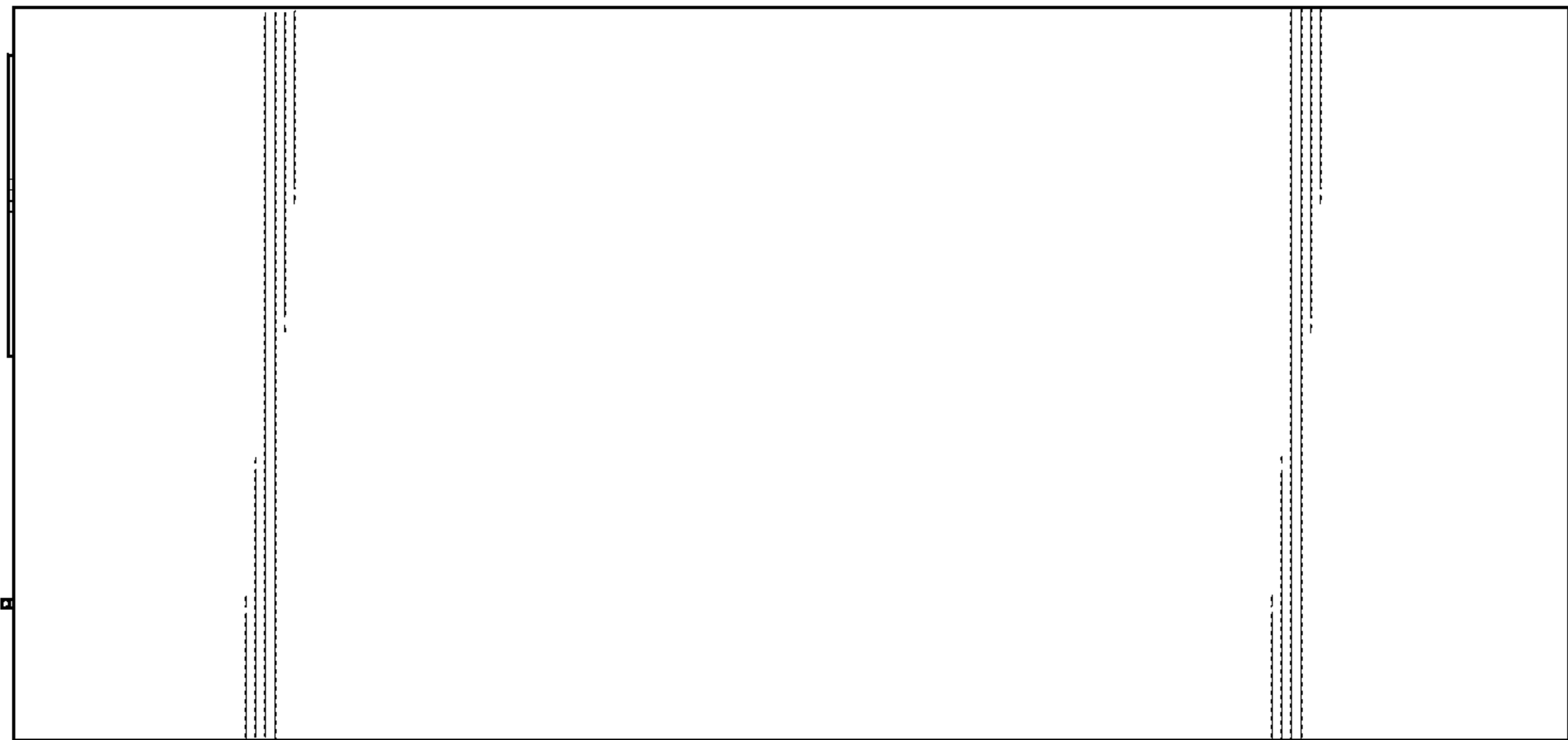

FIG. 10

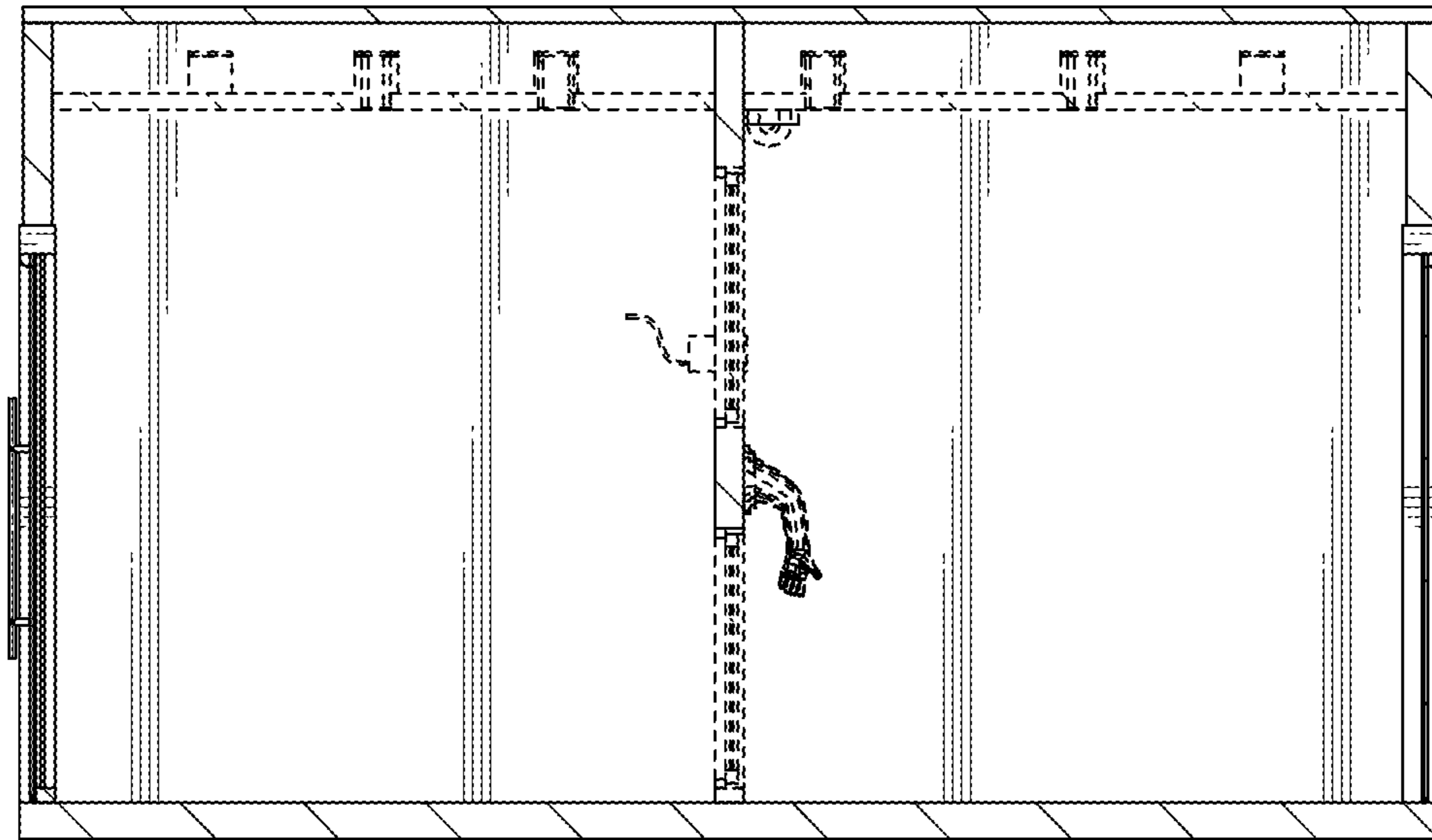

FIG. 11

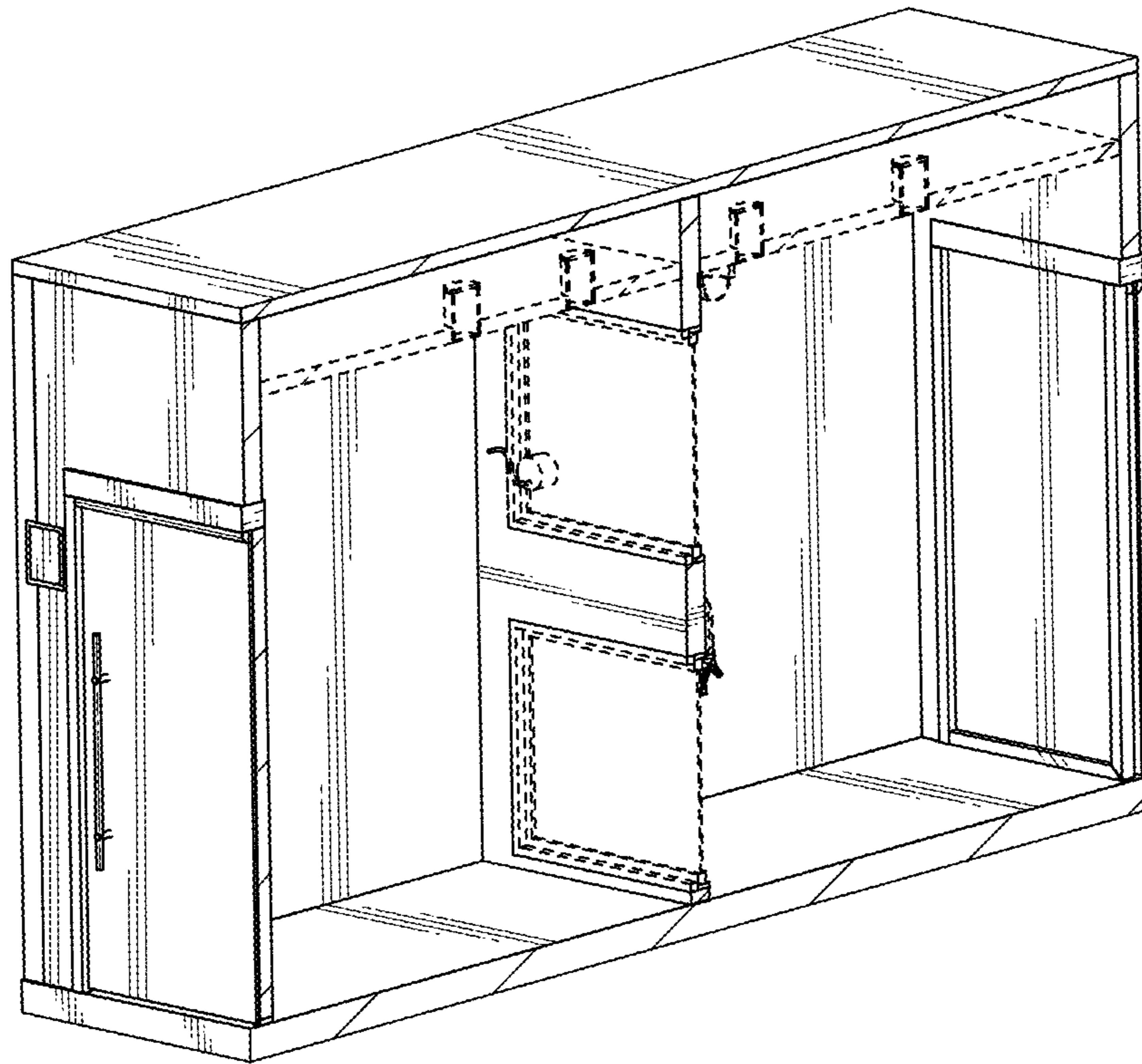

FIG. 12

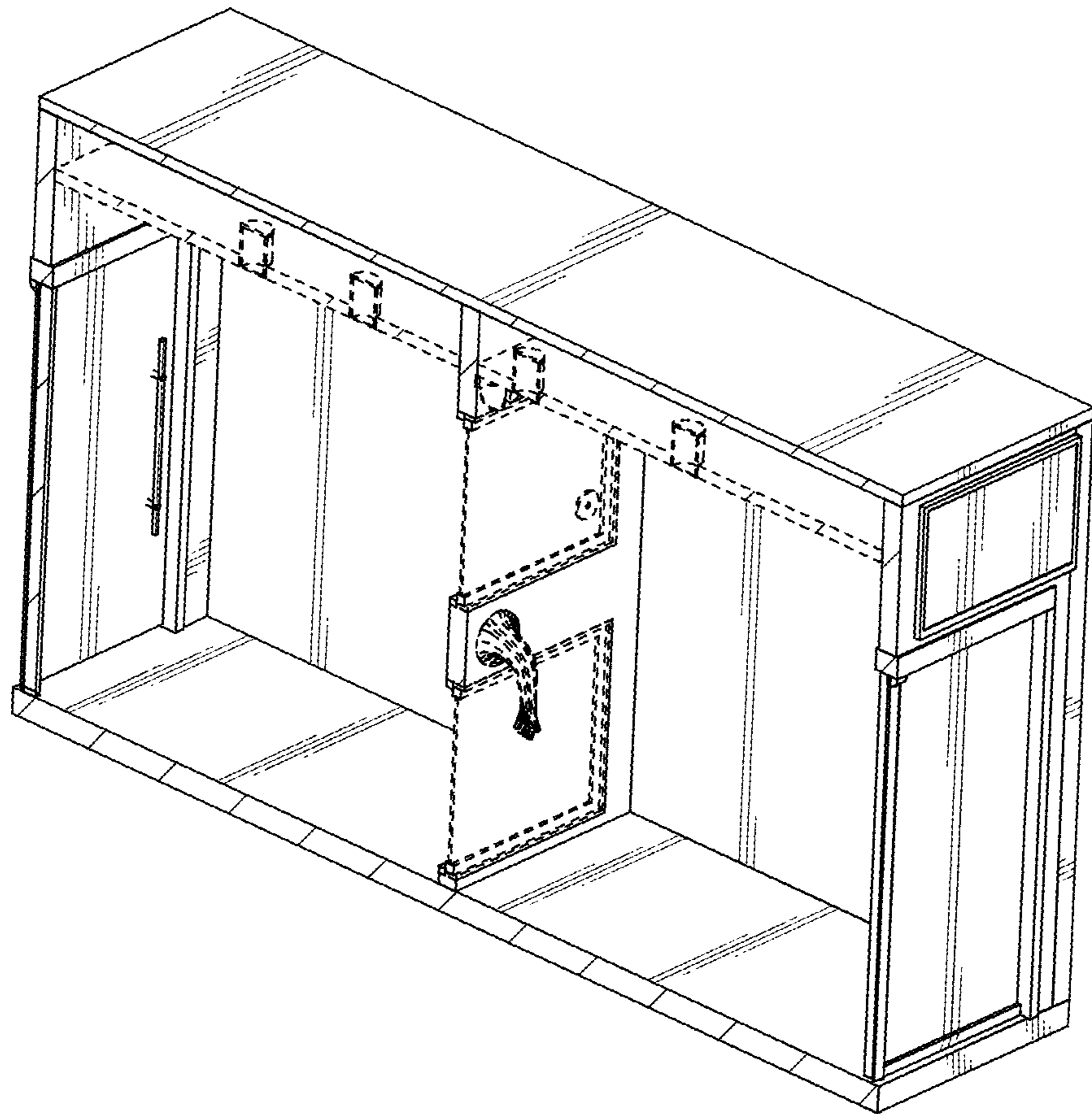

FIG. 13

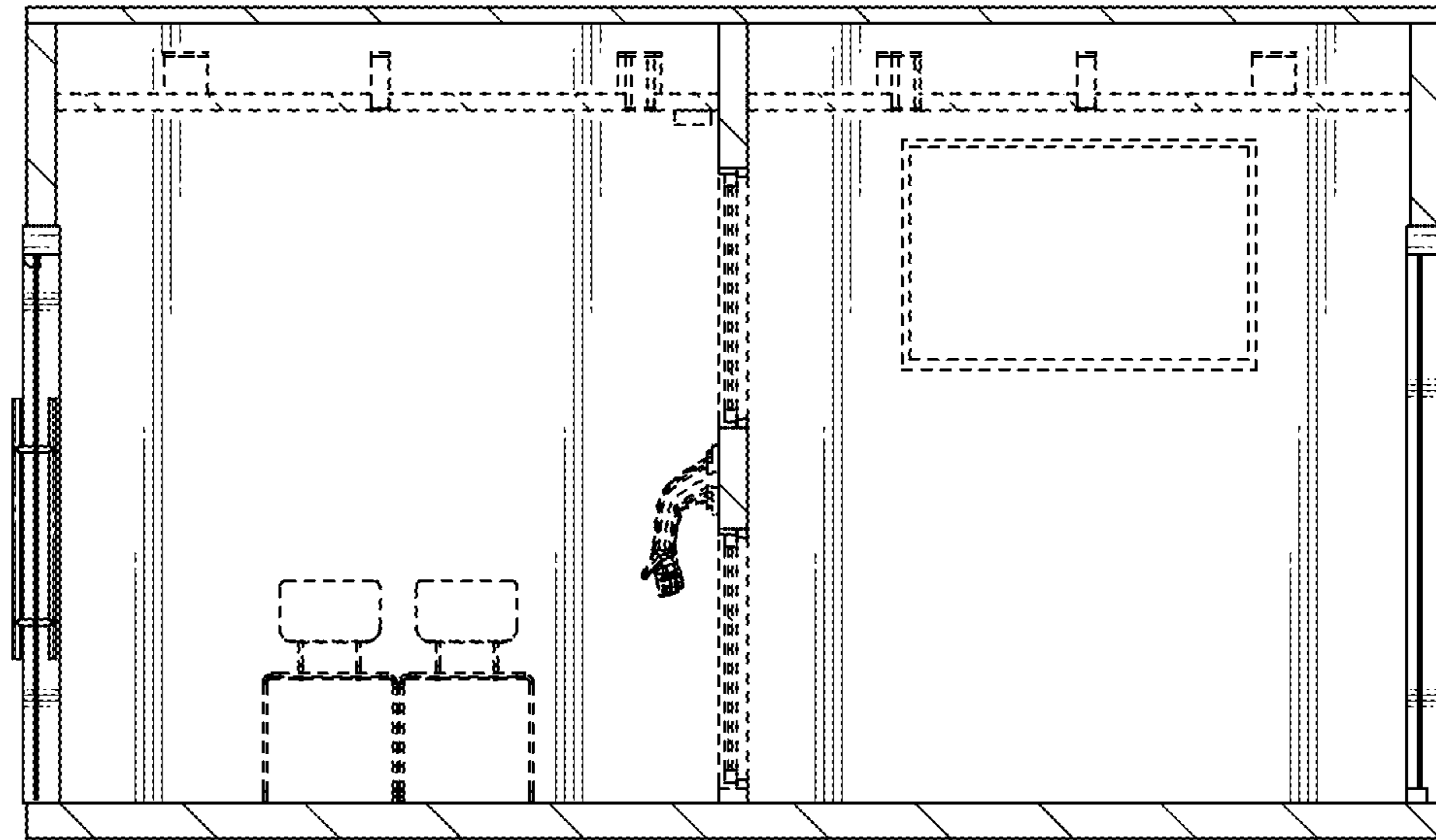

FIG. 14

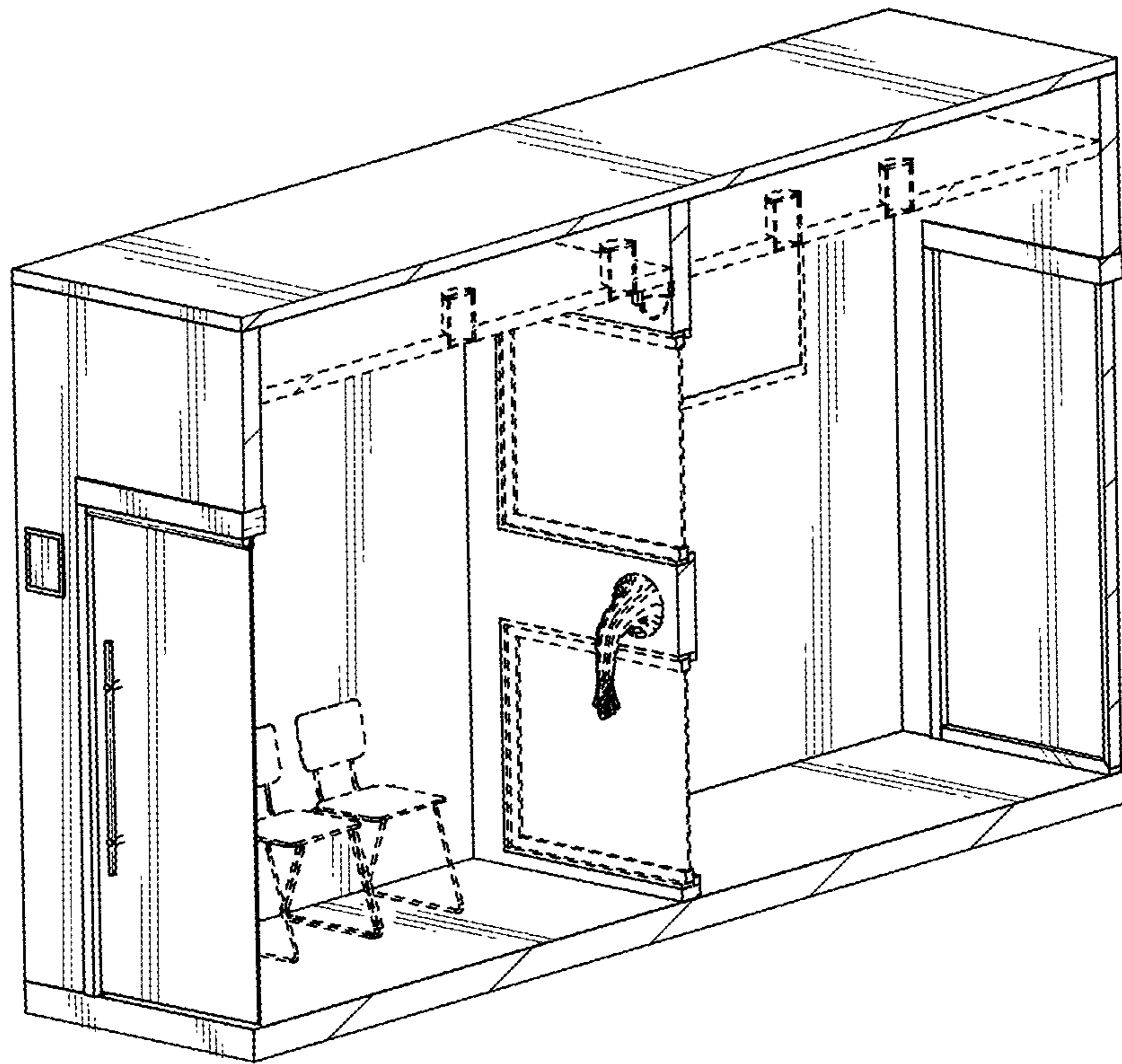

FIG. 15

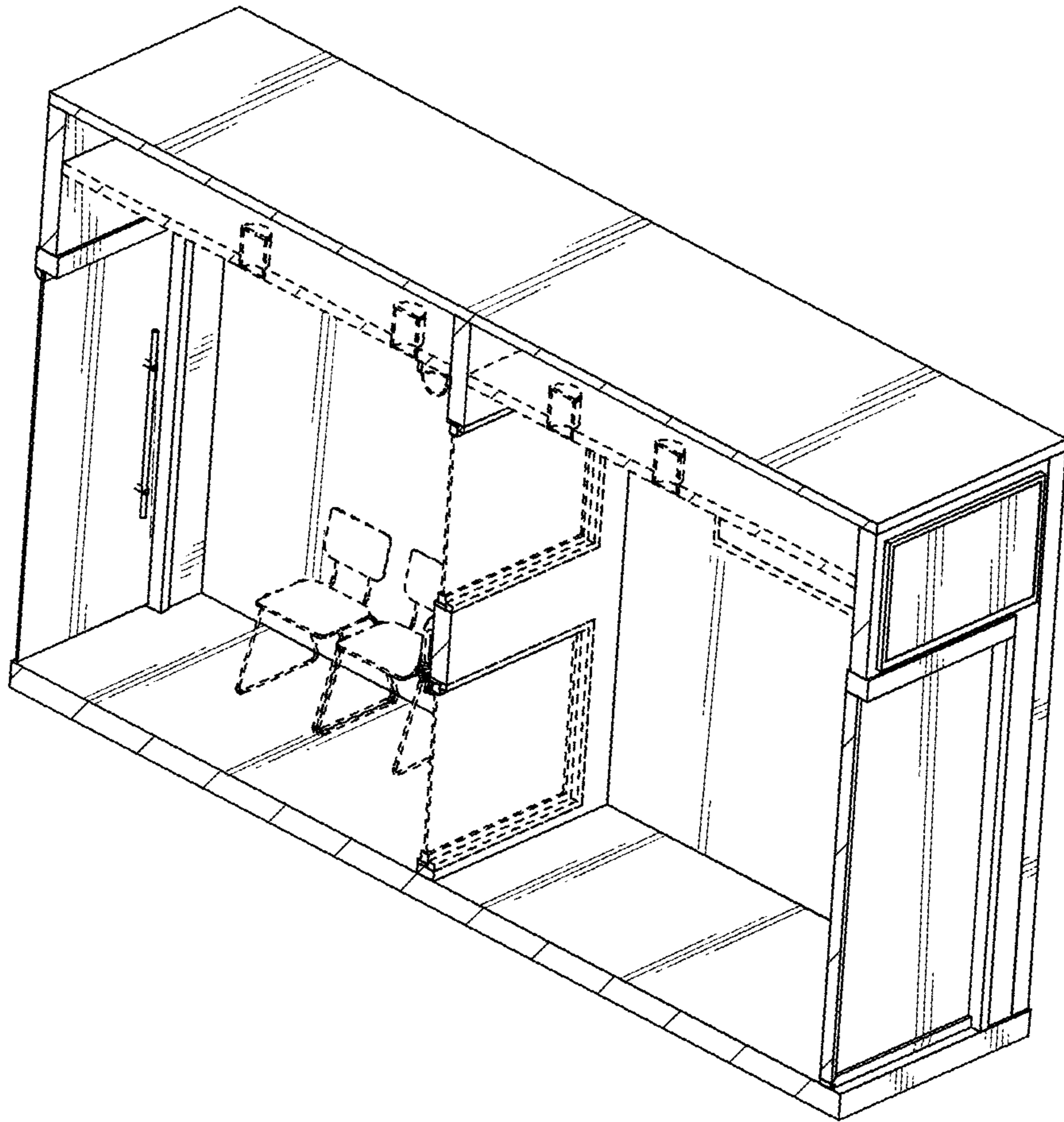

FIG. 16

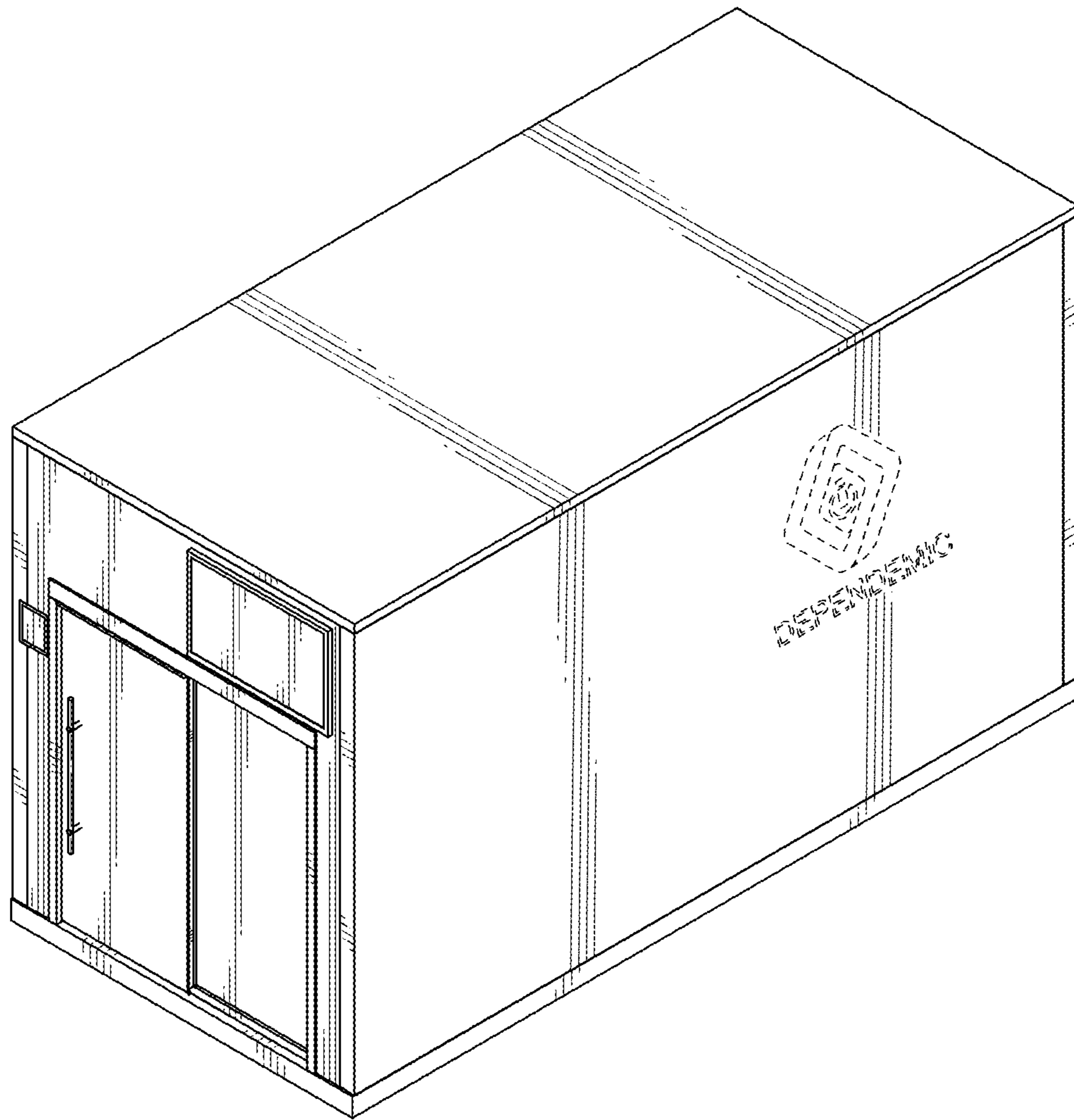

FIG. 17