



US00D967428S

(12) **United States Design Patent** (10) **Patent No.:** **US D967,428 S**
Kim et al. (45) **Date of Patent:** **** Oct. 18, 2022**

(54) **UPPER POST FOR DENTAL IMPLANTS**
(71) Applicant: **DIO CORPORATION**, Busan (KR)
(72) Inventors: **Jin Cheol Kim**, Busan (KR); **Jin Baek Kim**, Busan (KR)
(73) Assignee: **DIO CORPORATION**, Busan (KR)
(**) Term: **15 Years**
(21) Appl. No.: **29/782,542**
(22) Filed: **May 7, 2021**

D652,929 S * 1/2012 Sibhatu D8/387
D663,419 S * 7/2012 Mashio D24/156
D667,955 S * 9/2012 Spahn D24/156
D729,387 S * 5/2015 Sicurelli D24/156
D732,669 S * 6/2015 Fisler D24/156
D765,862 S * 9/2016 Schendel D24/156
D800,308 S * 10/2017 LeBeau A61C 19/05
D24/156
D808,016 S * 1/2018 Kim D24/156
D808,525 S * 1/2018 Kim D24/156
D817,493 S * 5/2018 Cho D24/152
D906,522 S * 12/2020 Park D24/156
D946,757 S * 3/2022 Mirelez, Jr. D24/156
D946,758 S * 3/2022 Mirelez, Jr. D24/156
D946,759 S * 3/2022 Mirelez, Jr. D24/156
D946,760 S * 3/2022 Mirelez, Jr. D24/156

(30) **Foreign Application Priority Data**
Nov. 11, 2020 (KR) 30-2020-0054435
(51) **LOC (13) Cl.** **24-03**
(52) **U.S. Cl.**
USPC **D24/156**
(58) **Field of Classification Search**
USPC D24/156
CPC A61C 8/00; A61C 8/0089; A61C 8/0069;
A61C 8/0054; A61C 8/0096; A61C
8/0039; A61C 8/0063; A61C 8/006; A61C
8/0001; A61C 8/0012; A61C 8/0075;
A61C 8/0083; A61C 13/225
See application file for complete search history.

* cited by examiner

Primary Examiner — Charles D Hanson
(74) *Attorney, Agent, or Firm* — Patricia A Wilczynski
Brozek; Pokalsky Wilczynski Brozek LLP

(56) **References Cited**
U.S. PATENT DOCUMENTS
D523,145 S * 6/2006 Gabrielsson D24/156
D573,259 S * 7/2008 Park D8/387
D587,373 S * 2/2009 Purga D24/156
D612,056 S * 3/2010 White, III D24/156
D641,877 S * 7/2011 Aldecoa D24/156
D642,271 S * 7/2011 Aldecoa D24/156

(57) **CLAIM**

The ornamental design for an upper post for dental implants, as shown and described.

DESCRIPTION

FIG. 1 is a perspective view of an upper post for dental implants showing the new design; FIG. 2 is a front elevation view thereof; FIG. 3 is a back elevation view thereof; FIG. 4 is a left side view thereof; FIG. 5 is a right side view thereof; FIG. 6 is a top plan view thereof; FIG. 7 is a bottom plan view thereof; and, FIG. 8 is a cross-sectional view thereof taken along line 8-8 in FIG. 6.

1 Claim, 5 Drawing Sheets

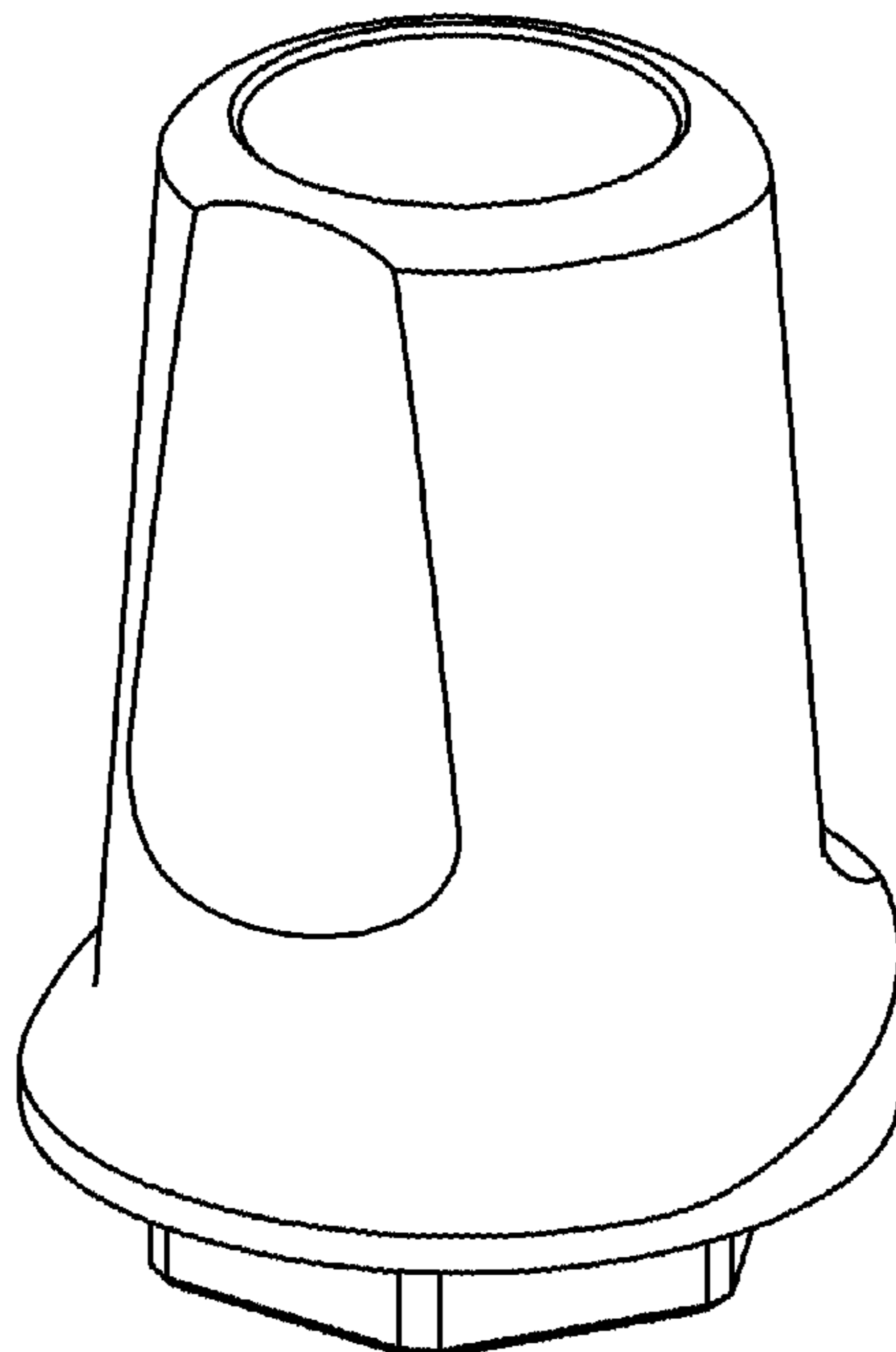

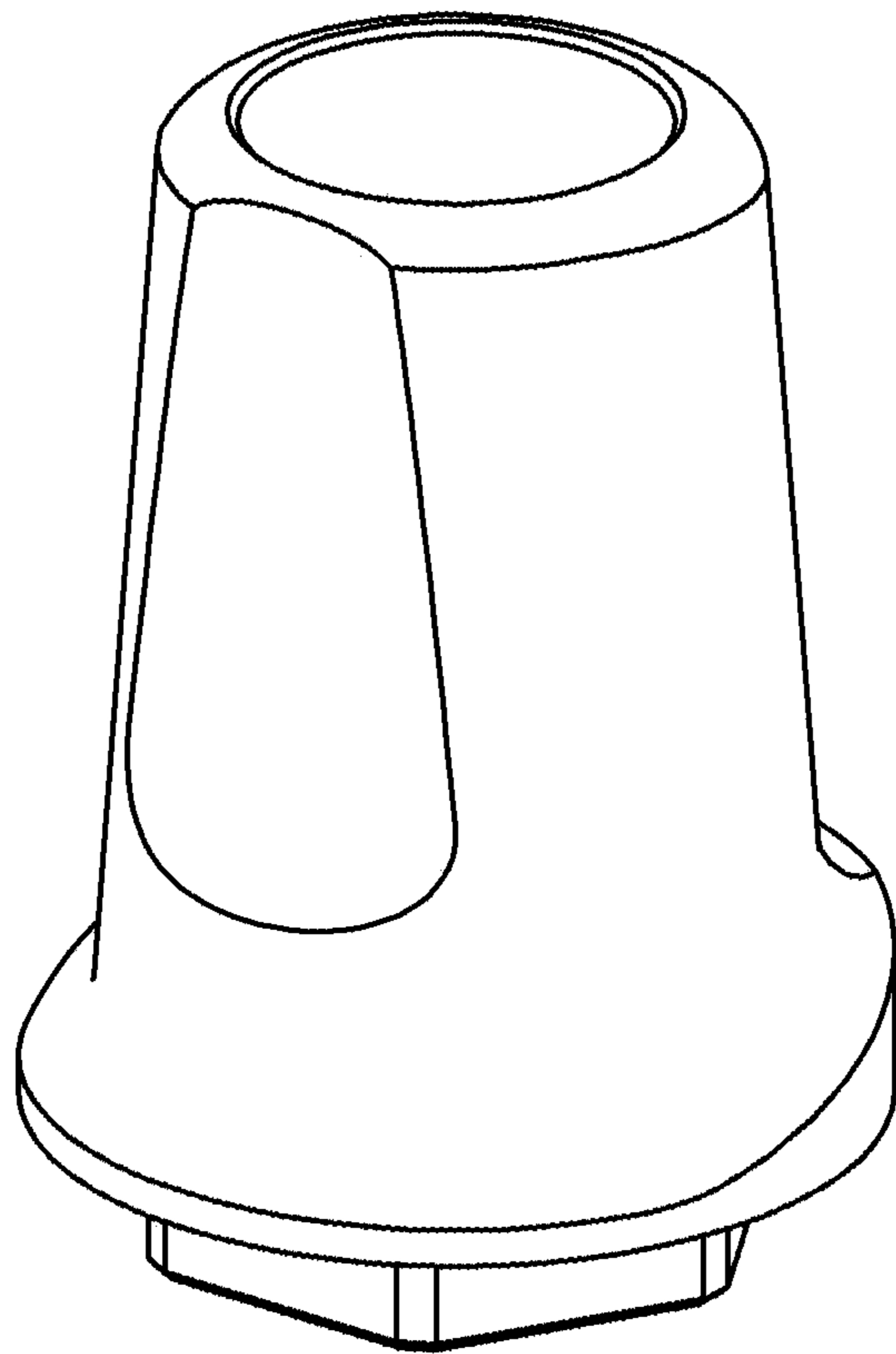

Fig. 1

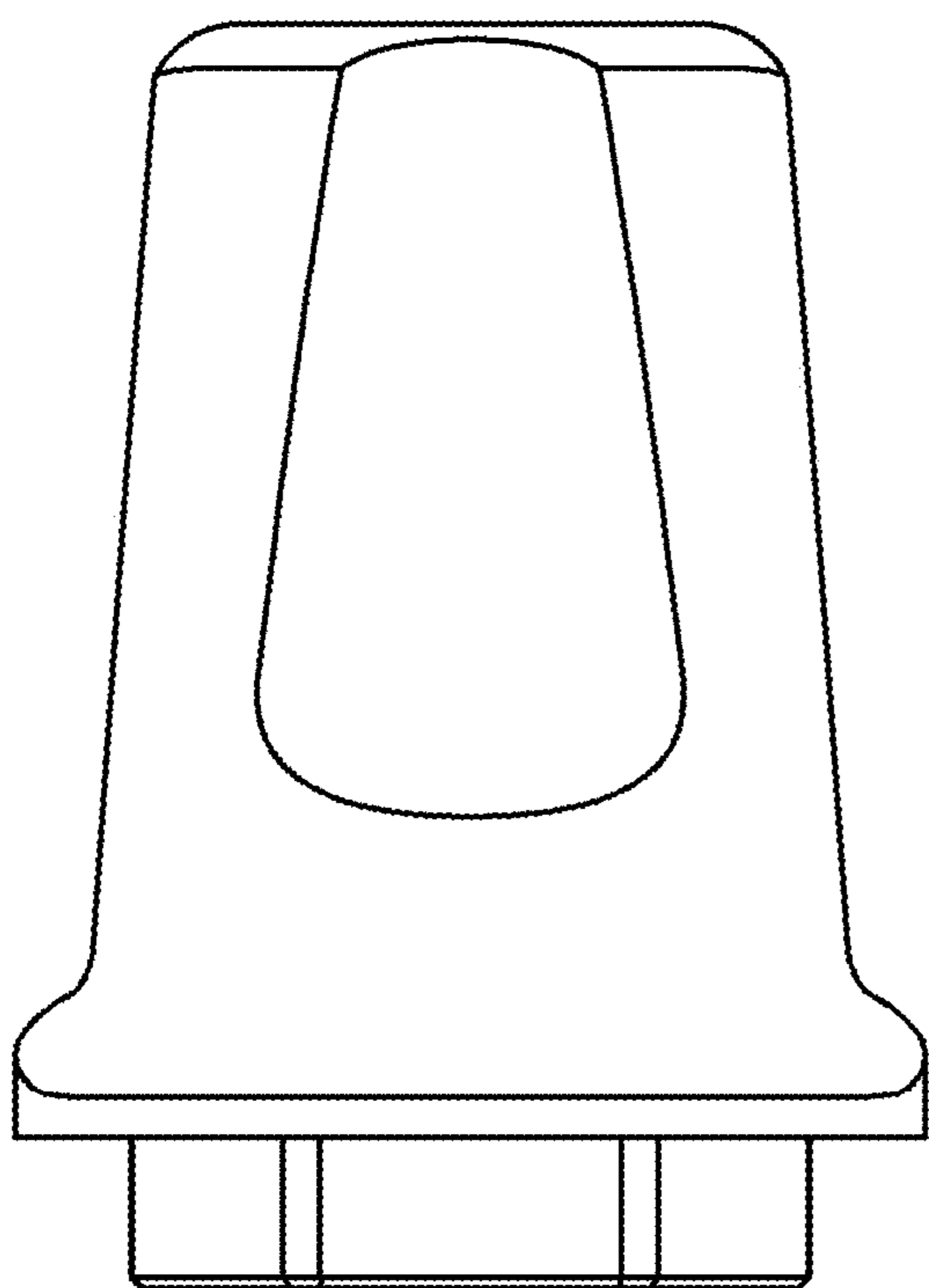

Fig. 2

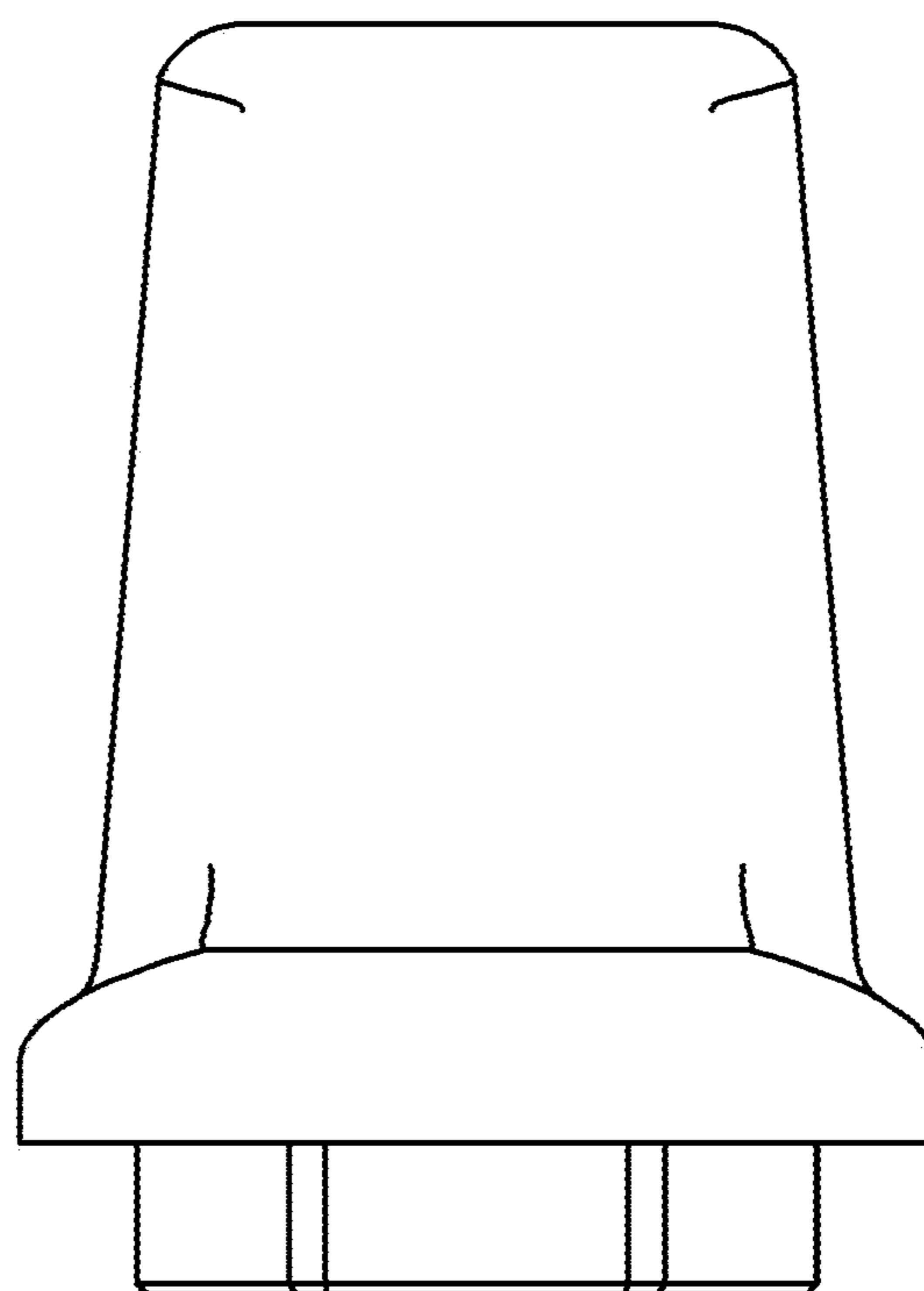

Fig. 3

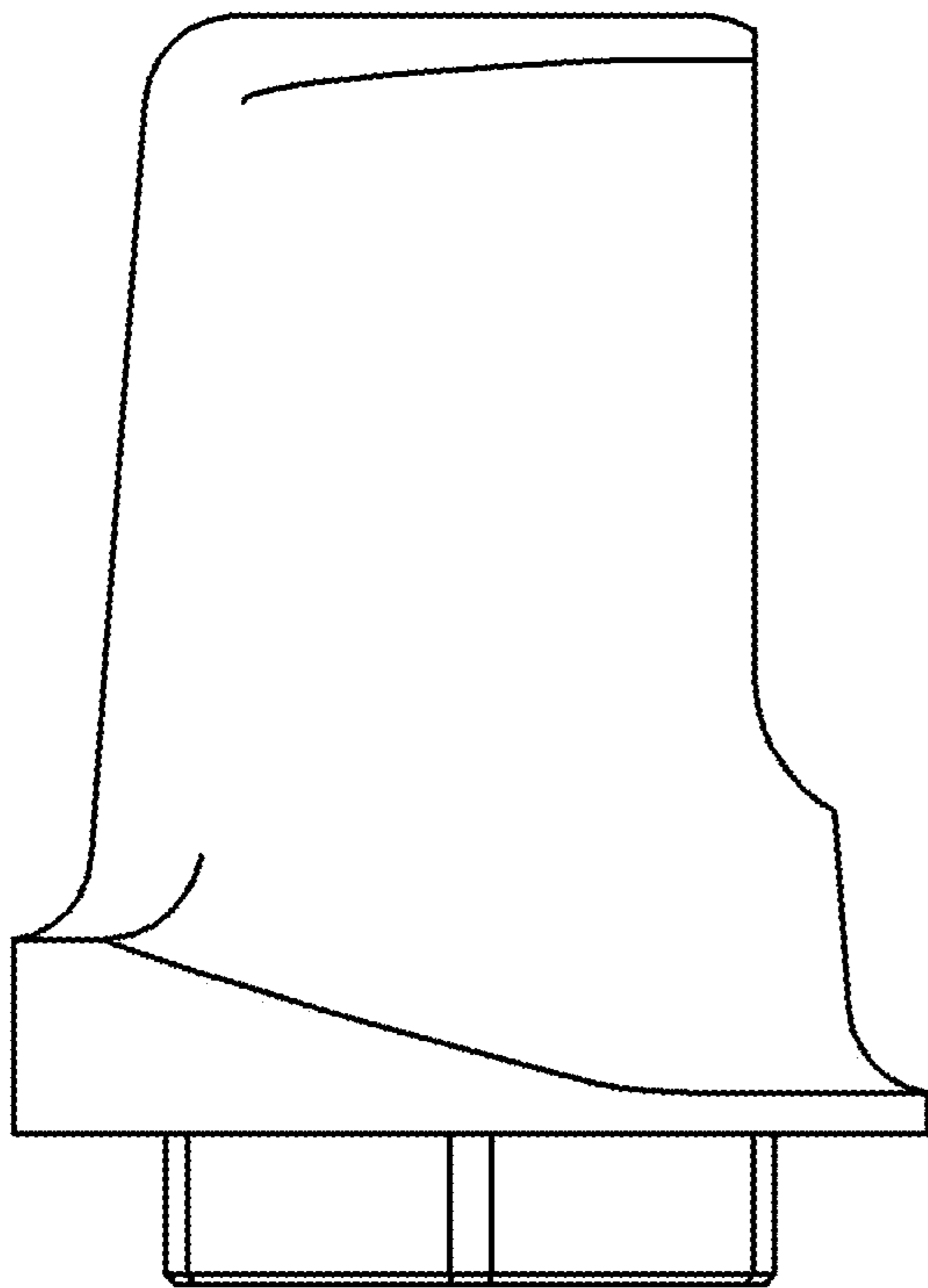

Fig. 4

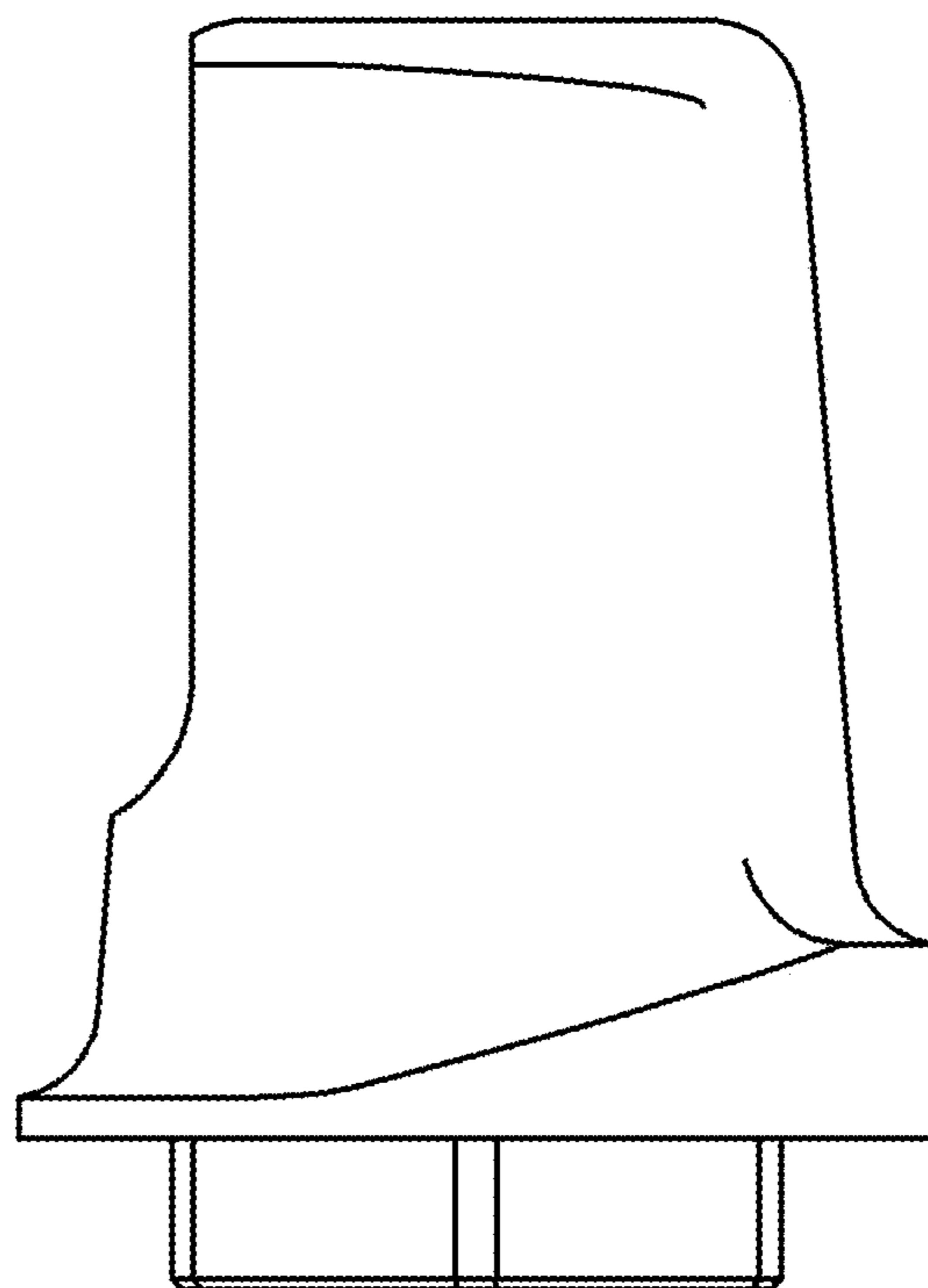

Fig. 5

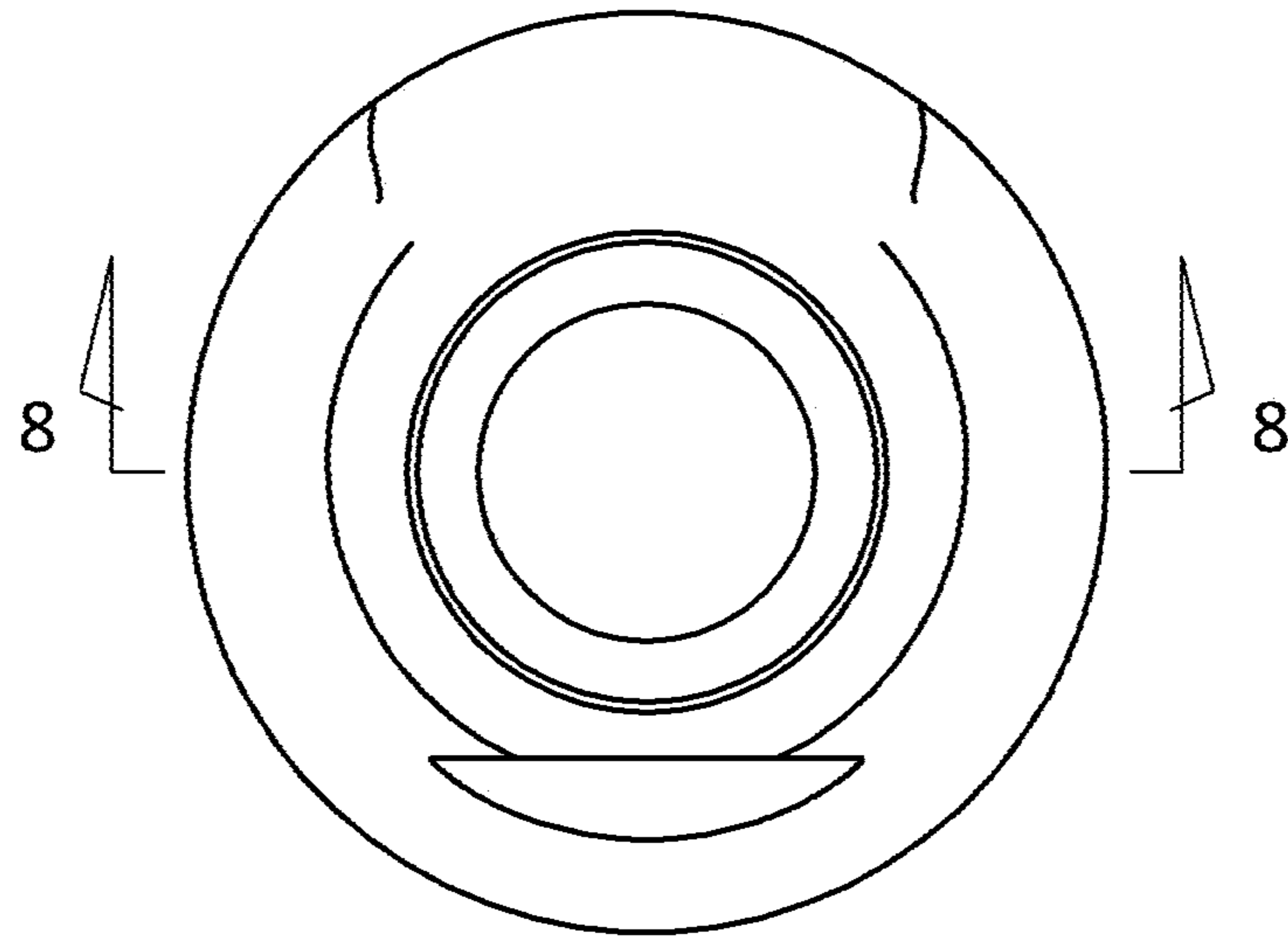

Fig. 6

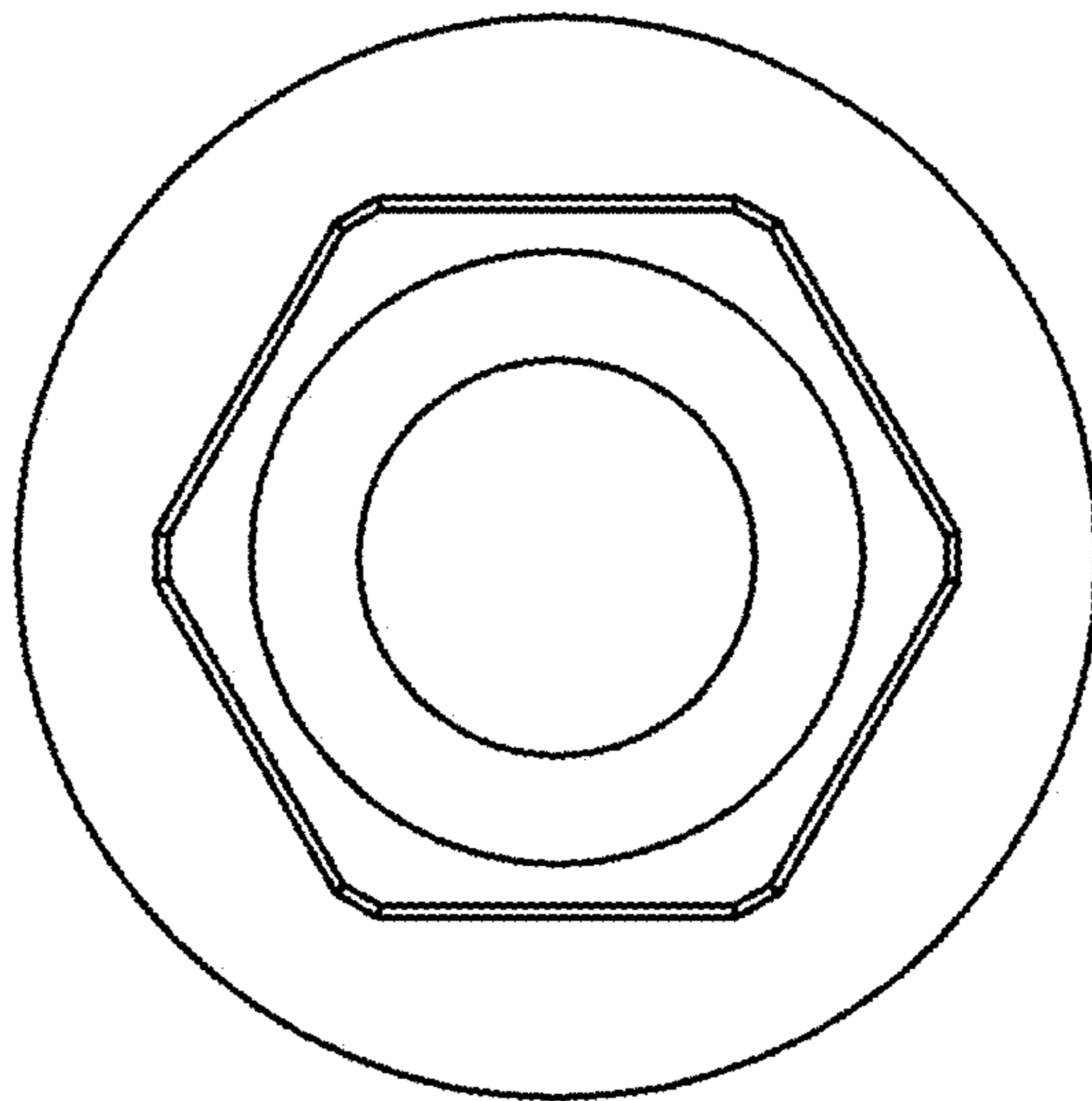

Fig. 7

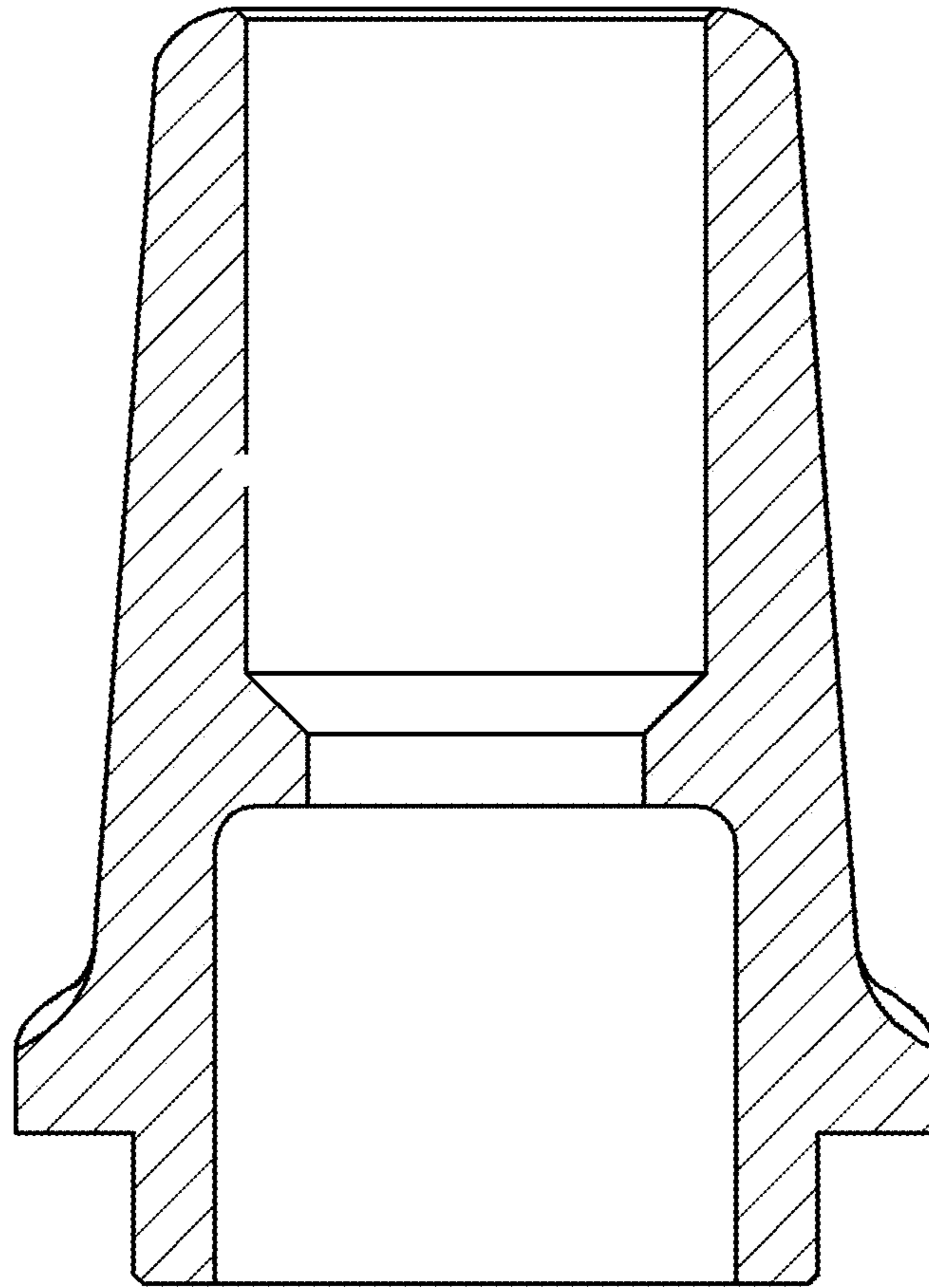

Fig. 8