



US00D967367S

(12) **United States Design Patent** (10) **Patent No.:** **US D967,367 S**
Han et al. (45) **Date of Patent:** **** Oct. 18, 2022**

(54) **AIR PURIFIER**

Assistant Examiner — Jonathan E Fiencke

(71) Applicant: **LG ELECTRONICS INC.**, Seoul (KR)

(74) *Attorney, Agent, or Firm* — Birch, Stewart, Kolasch & Birch, LLP

(72) Inventors: **Sungkyong Han**, Seoul (KR); **Sehwan Bae**, Seoul (KR); **Myungwhoon Lee**, Seoul (KR); **Kangeui Cho**, Seoul (KR); **Jiug Ha**, Seoul (KR)

(57) **CLAIM**

We claim the ornamental design for an air purifier, as shown and described.

(73) Assignee: **LG ELECTRONICS INC.**, Seoul (KR)

DESCRIPTION

(**) Term: **15 Years**

FIG. 1 is a perspective view of an air purifier showing the new design;

(21) Appl. No.: **29/721,778**

FIG. 2 is a front elevation view thereof;

(22) Filed: **Jan. 23, 2020**

FIG. 3 is a rear elevation view thereof;

(30) **Foreign Application Priority Data**

Jul. 25, 2019 (KR) 30-2019-0035874

FIG. 4 is a left-side elevation view thereof;

(51) **LOC (13) Cl.** **23-04**

FIG. 5 is a right-side elevation view thereof;

(52) **U.S. Cl.**

USPC **D23/364**

FIG. 6 is a top plan view thereof;

(58) **Field of Classification Search**

USPC .. D7/536, 538, 553.8, 554.2, 602–604, 612; D9/428, 545, 738, 763–764, 767; D23/332–335, 337, 342, 352, 355–366, D23/369–370; D5/1–3, 56–63

FIG. 7 is a bottom plan view thereof;

CPC .. A61L 9/00; A61L 9/22; B01D 47/00; B01D 47/027; B01D 2259/4508; B03C 3/155;

FIG. 8 is a perspective view thereof showing the circulator part at an angle;

(Continued)

FIG. 9 is a front elevation view thereof;

(56) **References Cited**

U.S. PATENT DOCUMENTS

D566,404 S * 4/2008 Harkenrider D5/60
D566,971 S * 4/2008 Harkenrider D5/60
D569,628 S * 5/2008 Harkenrider D5/60

FIG. 10 is a rear elevation view thereof;

(Continued)

FIG. 11 is a left-side elevation view thereof;

FIG. 12 is a right-side elevation view thereof;

FIG. 13 is a top plan view thereof;

FIG. 14 is a bottom plan view thereof;

FIG. 15 is a perspective view thereof showing the circulator part at another angle;

FIG. 16 is a front elevation view thereof;

FIG. 17 is a rear elevation view thereof;

FIG. 18 is a left-side elevation view thereof;

FIG. 19 is a right-side elevation view thereof;

FIG. 20 is a top plan view thereof;

FIG. 21 is a bottom plan view thereof; and,

FIG. 22 is a partial perspective view thereof showing the air purifier in a state of use.

The evenly spaced broken lines and unshaded areas depict portions of the air purifier that form no part of the claimed design. The dot dash dot broken line in FIG. 22 denotes the boundary of the partial view and forms no part of the claimed design.

Primary Examiner — Karen S Acker

1 Claim, 22 Drawing Sheets

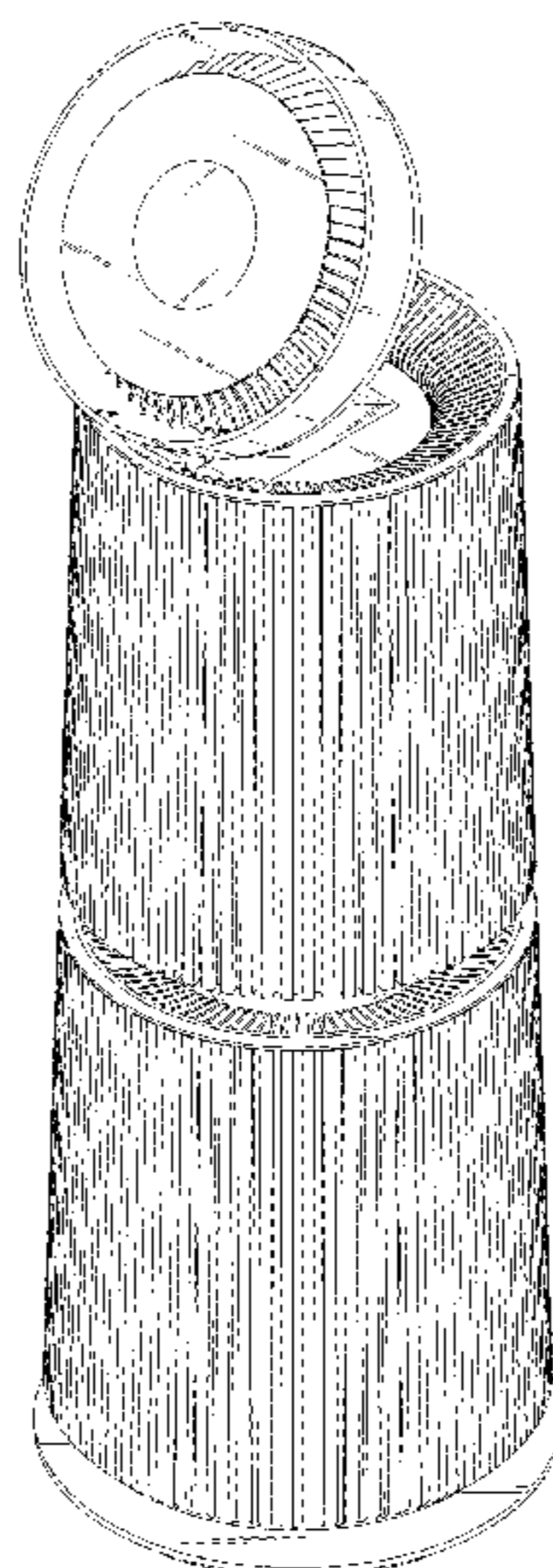

US D967,367 S

Page 2

(58) **Field of Classification Search**

CPC ... B03C 3/368; F24F 3/16; F24F 13/20; F24F 13/28

See application file for complete search history.

(56) **References Cited**

U.S. PATENT DOCUMENTS

D597,741 S * 8/2009 Harkenrider D5/60
D656,741 S * 4/2012 Snyder D5/60
D805,622 S * 12/2017 Lee D23/364
D818,096 S * 5/2018 Cho B01D 53/0415
D23/364
D818,097 S * 5/2018 Cho A61L 9/12
D23/364
D818,098 S * 5/2018 Cho B01D 46/0047
D23/364
D829,313 S * 9/2018 Cho F24F 13/28
D23/364

D829,314 S * 9/2018 Cho F24F 13/082
D23/364
D832,414 S * 10/2018 Sharma D23/364
D941,980 S * 1/2022 Zhang D23/364
D942,604 S * 2/2022 Yang D23/364
D943,072 S * 2/2022 Hu D23/356
D944,959 S * 3/2022 Wang D23/364
D947,341 S * 3/2022 Xia D23/364
D948,016 S * 4/2022 Yoon D23/364
D950,034 S * 4/2022 Peng D23/364
D951,412 S * 5/2022 Han D23/364
D952,817 S * 5/2022 Han D23/364
D954,241 S * 6/2022 Han D23/364
D957,607 S * 7/2022 Han D23/364
D957,609 S * 7/2022 Han D23/364
2018/0256770 A1 * 9/2018 Jang A61L 9/12
2019/0264948 A1 * 8/2019 Jung B01D 46/0047
2020/0188827 A1 * 6/2020 Yang B01D 53/0415
2021/0278097 A1 * 9/2021 Min F24F 13/20
2022/0011009 A1 * 1/2022 Lee F24F 13/28
2022/0011011 A1 * 1/2022 Yang F24F 13/082

* cited by examiner

FIG. 1

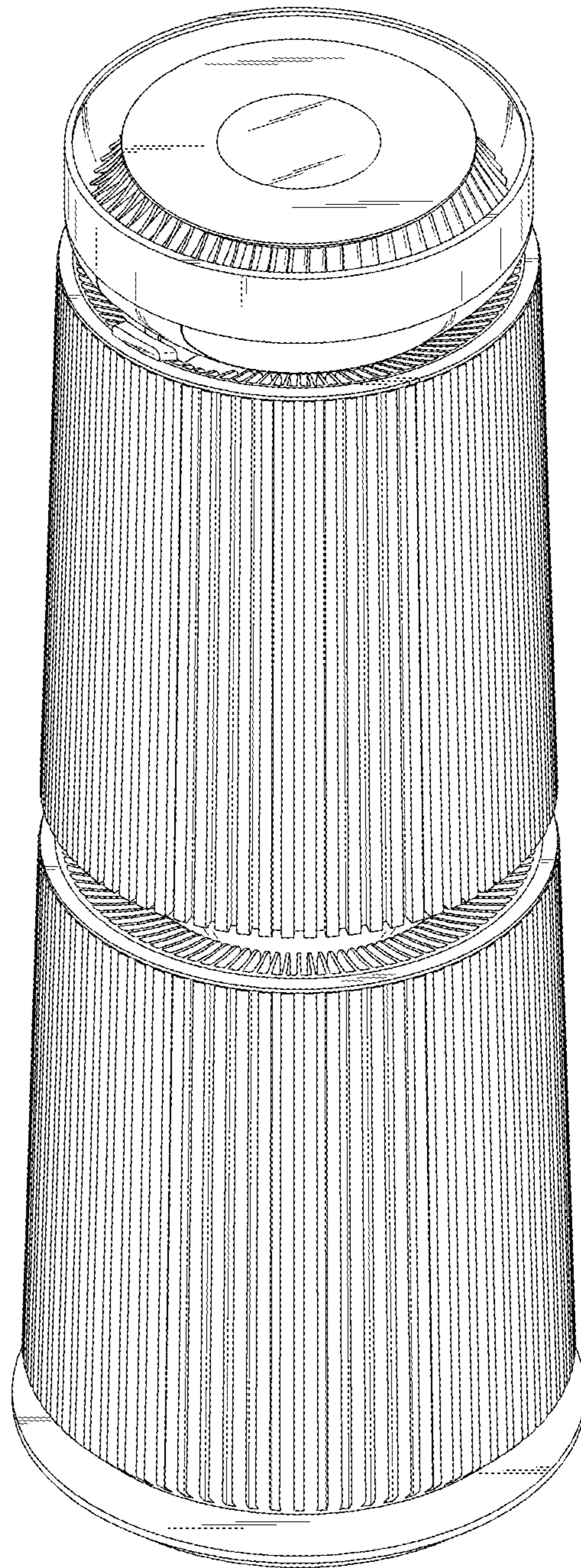

FIG. 2

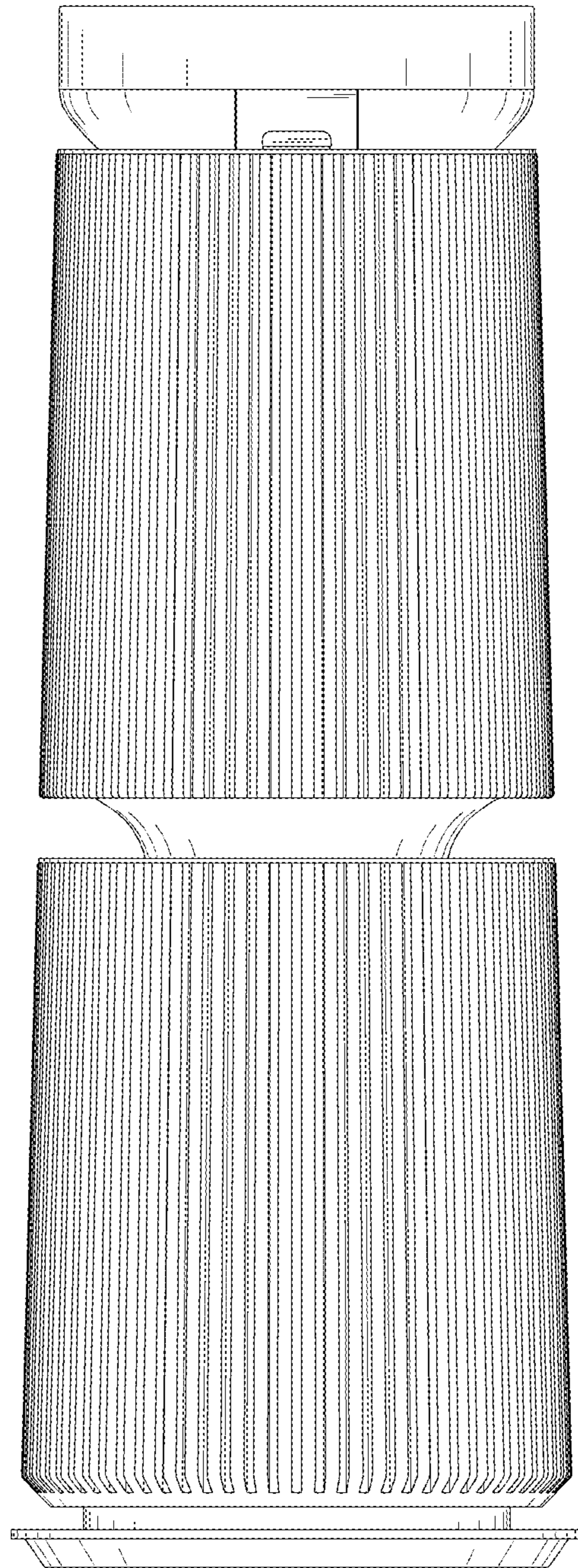

FIG. 3

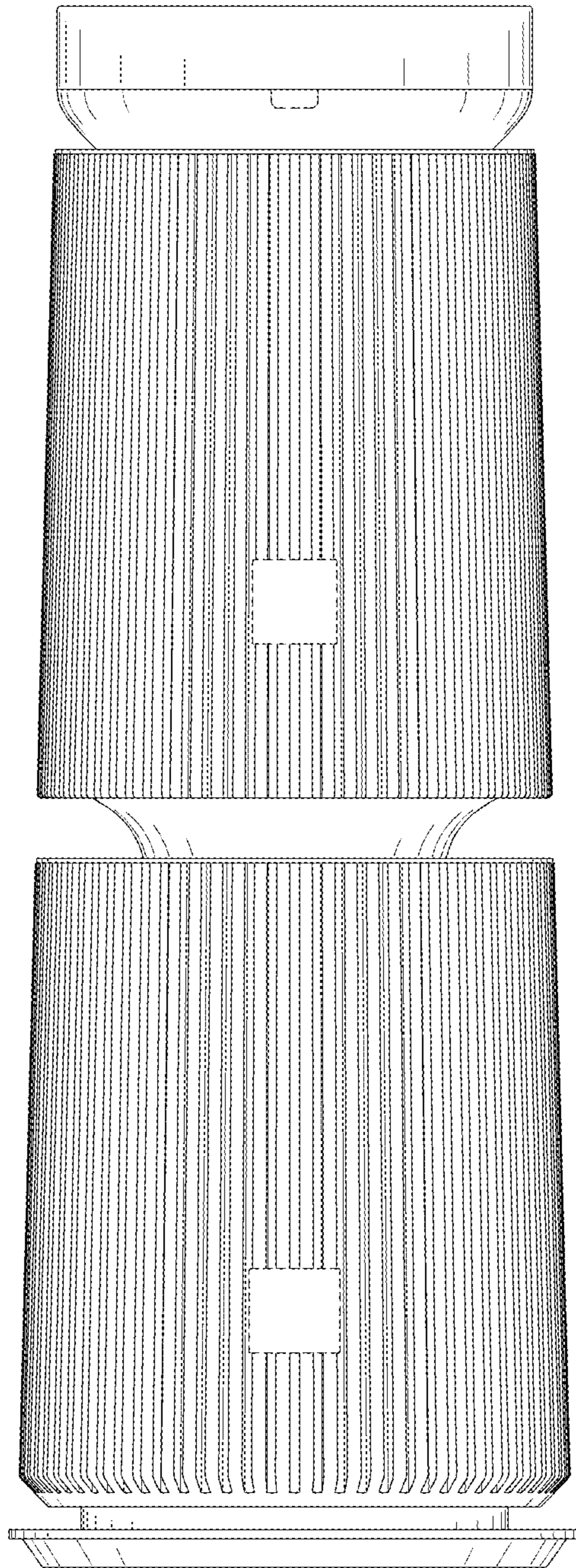

FIG. 4

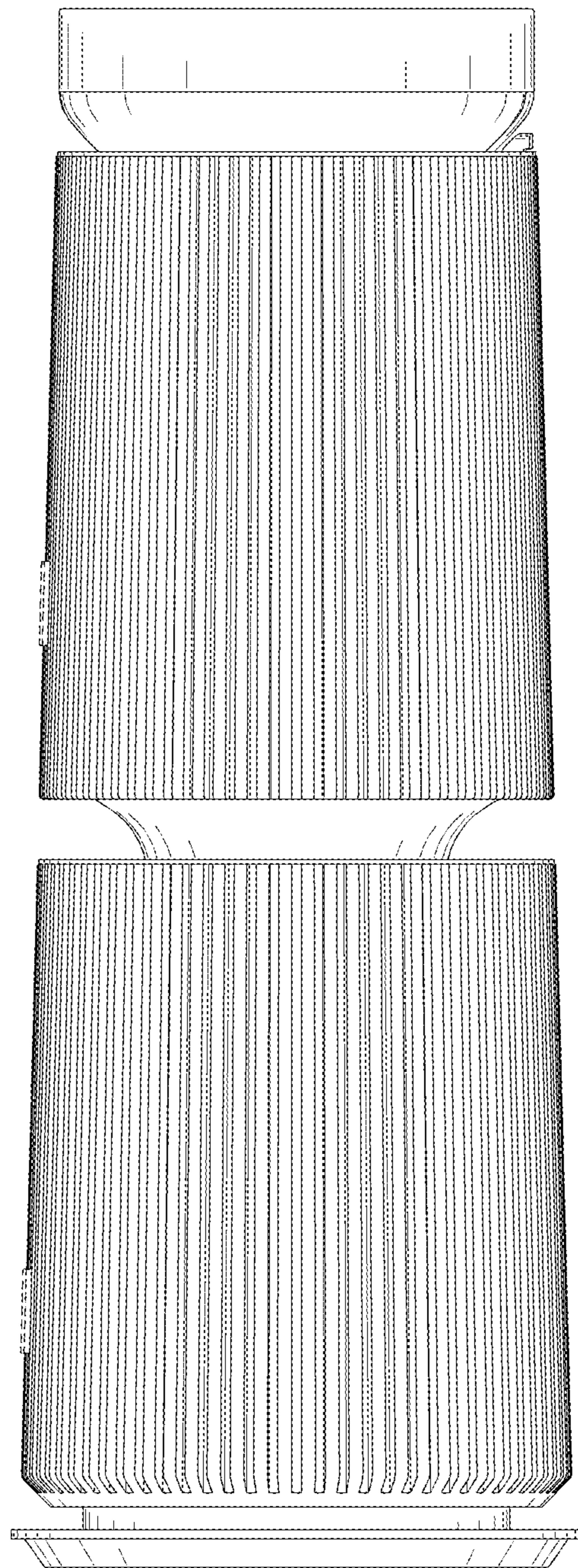

FIG. 5

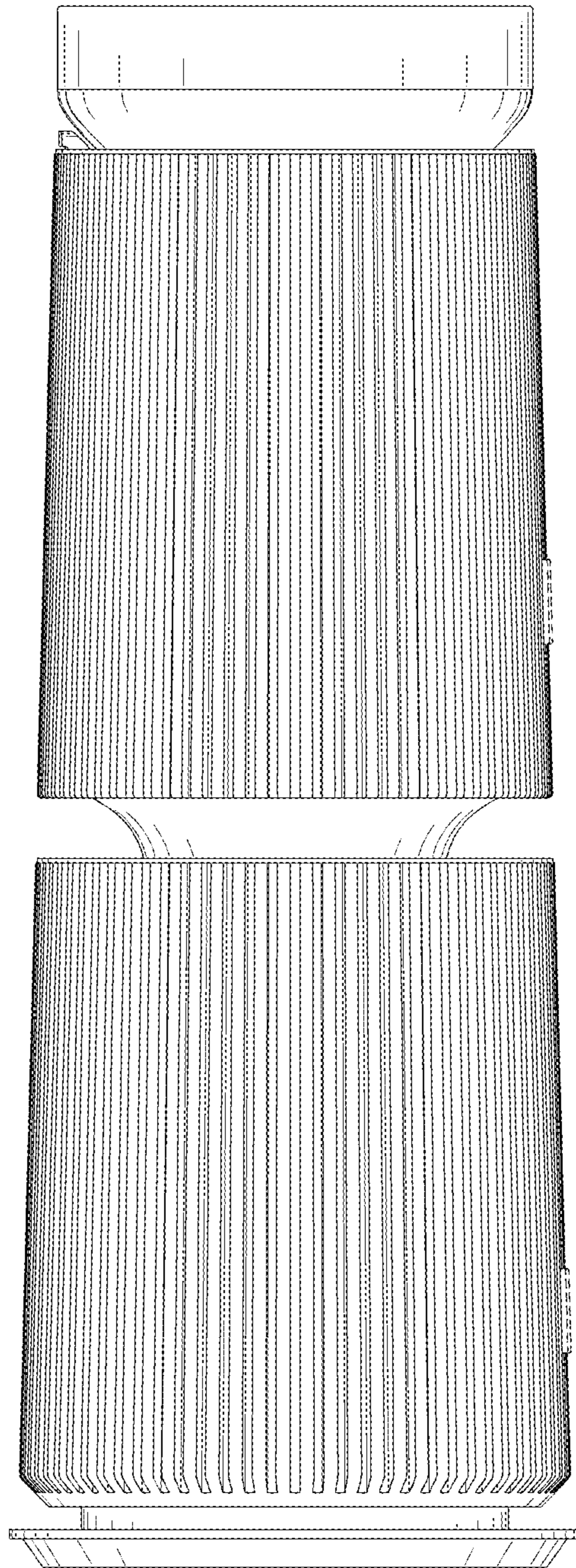

FIG. 6

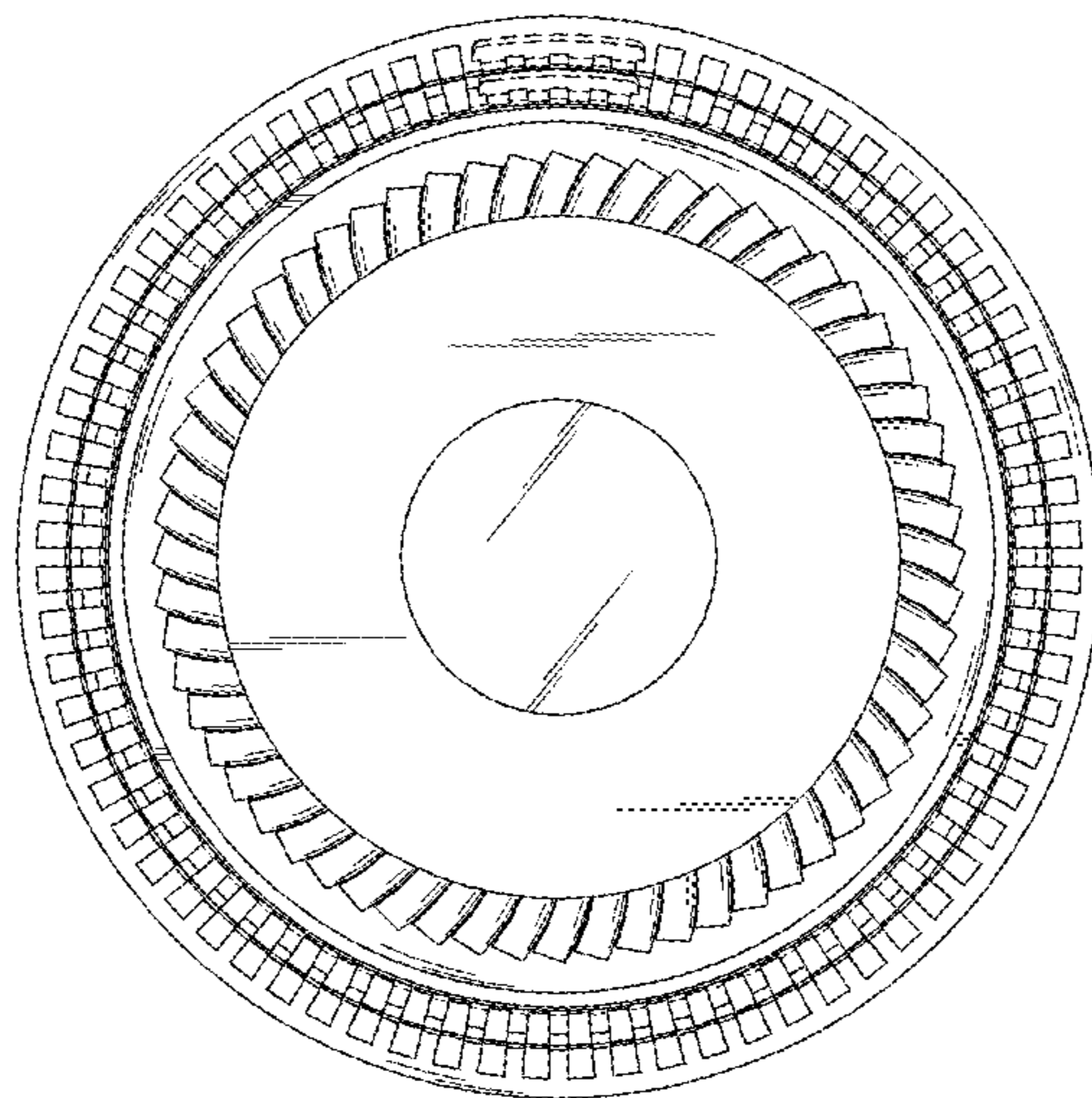

FIG. 7

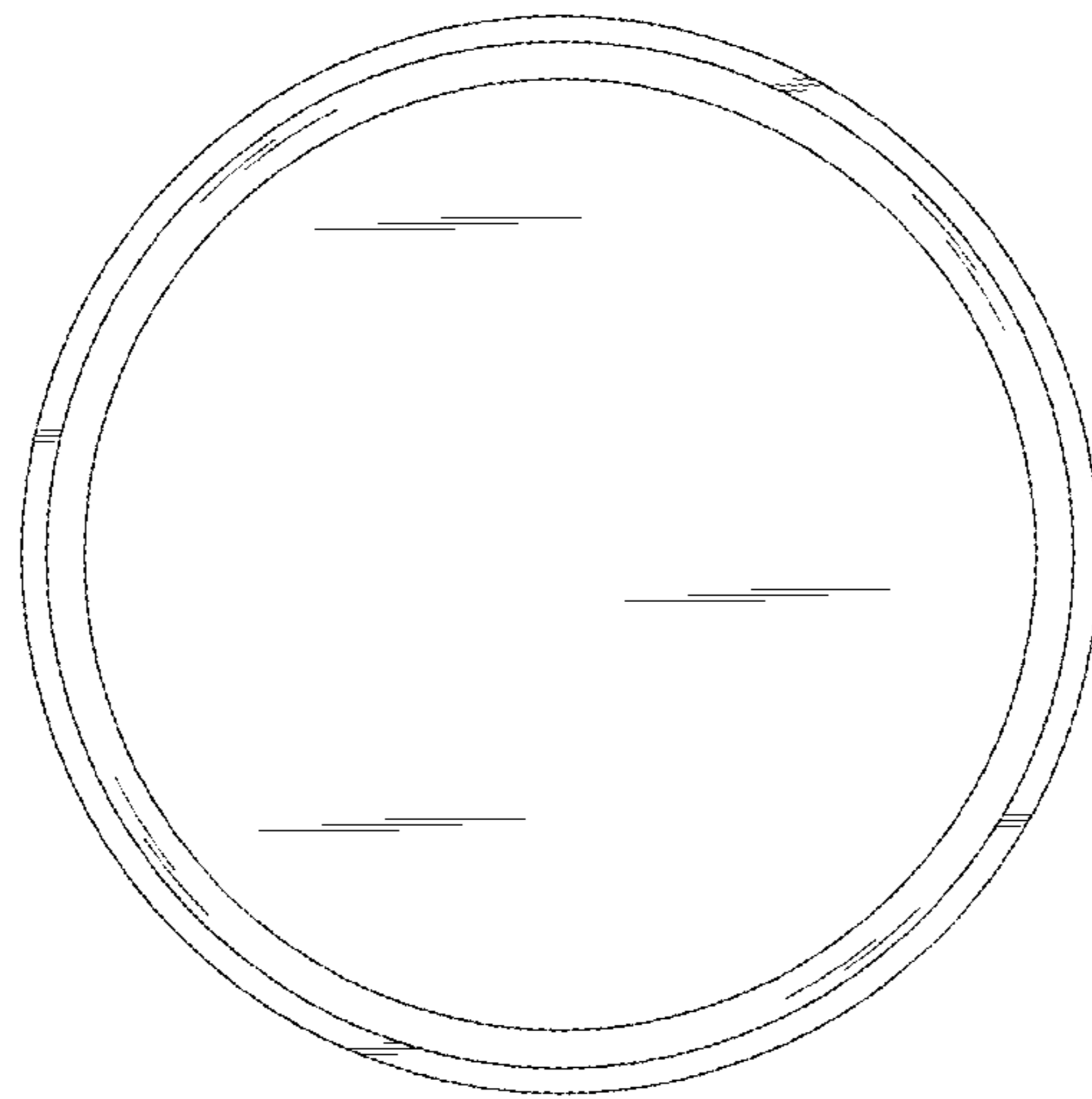

FIG. 8

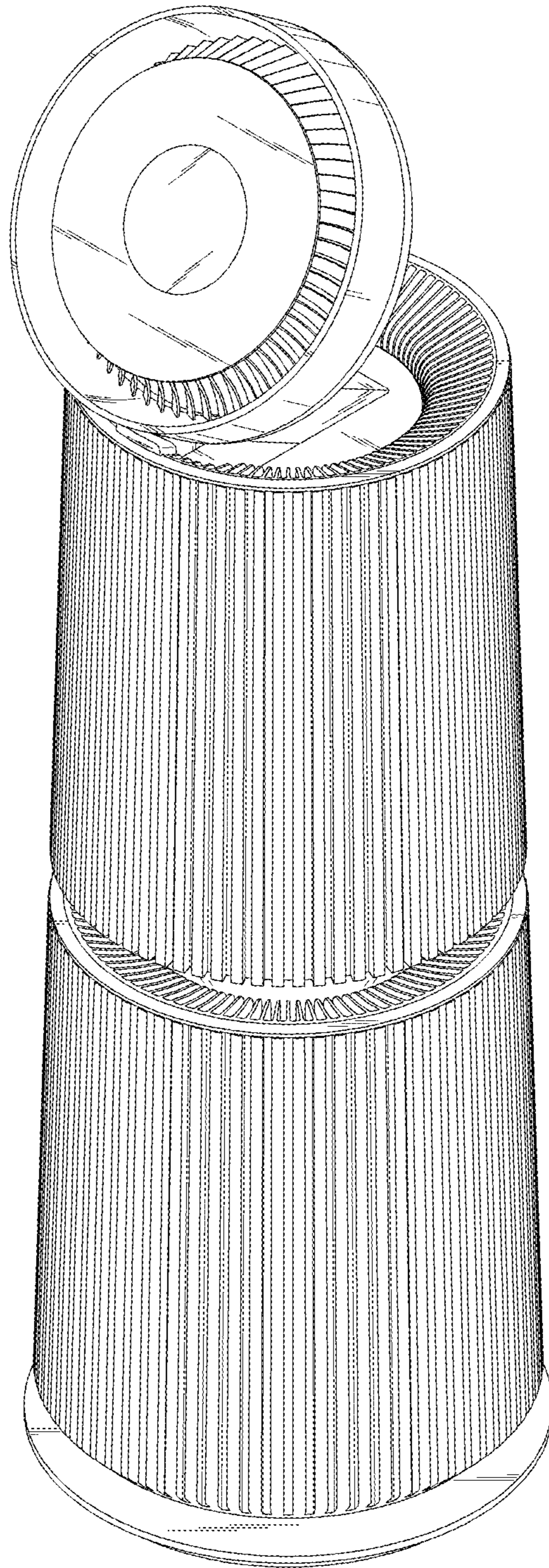

FIG. 9

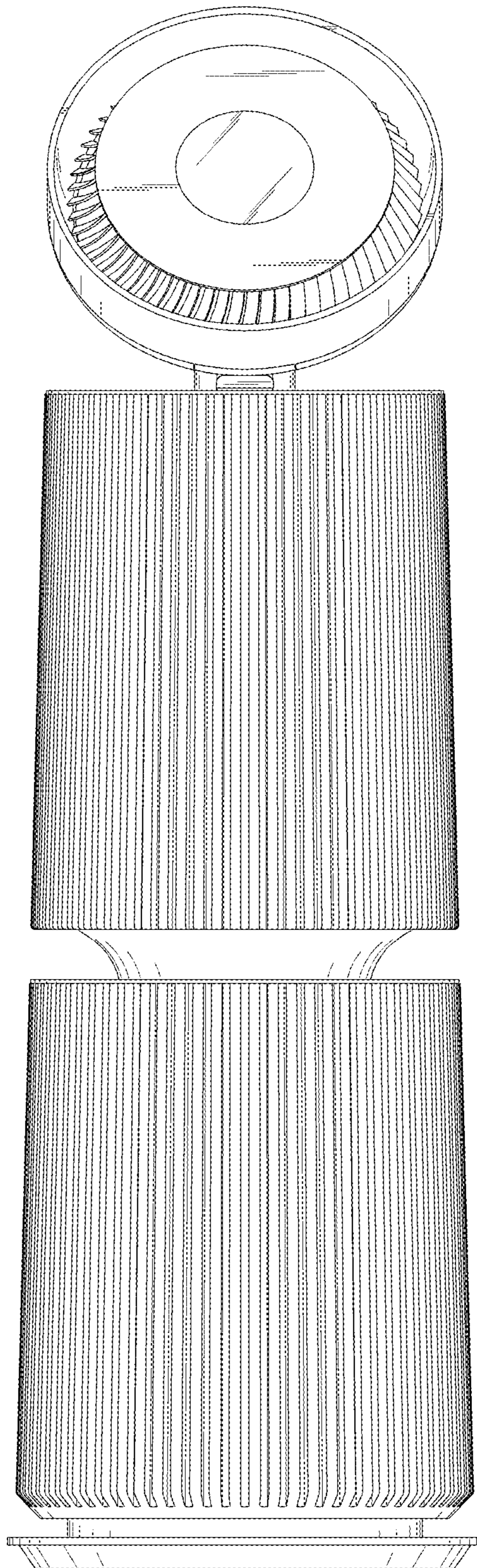

FIG. 10

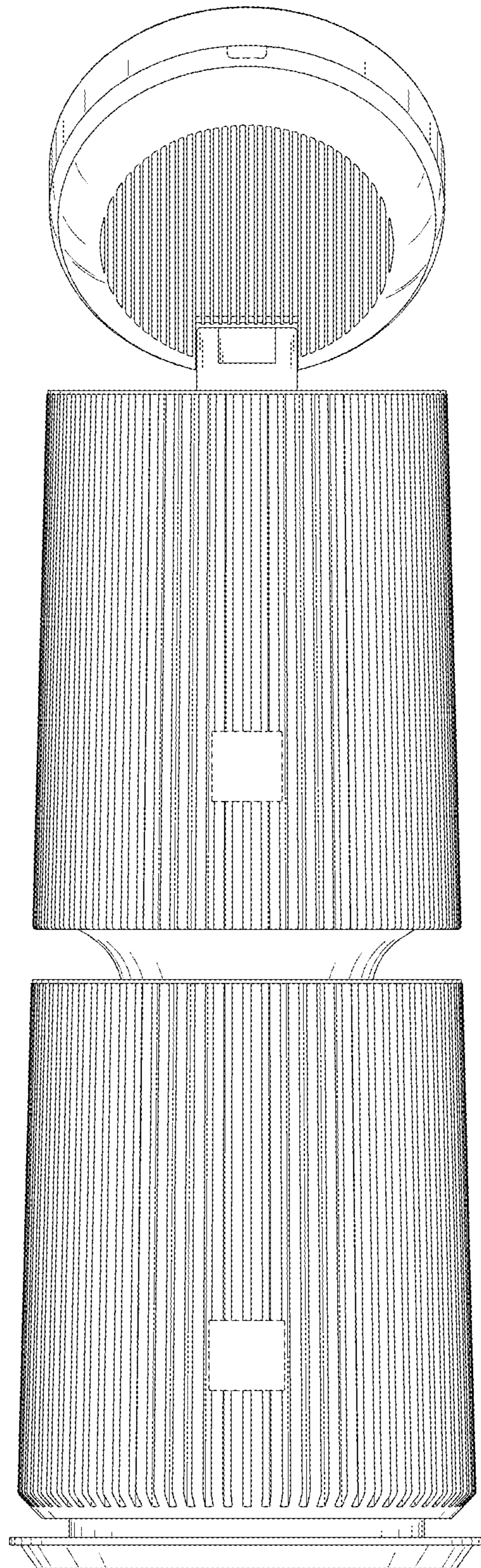

FIG. 11

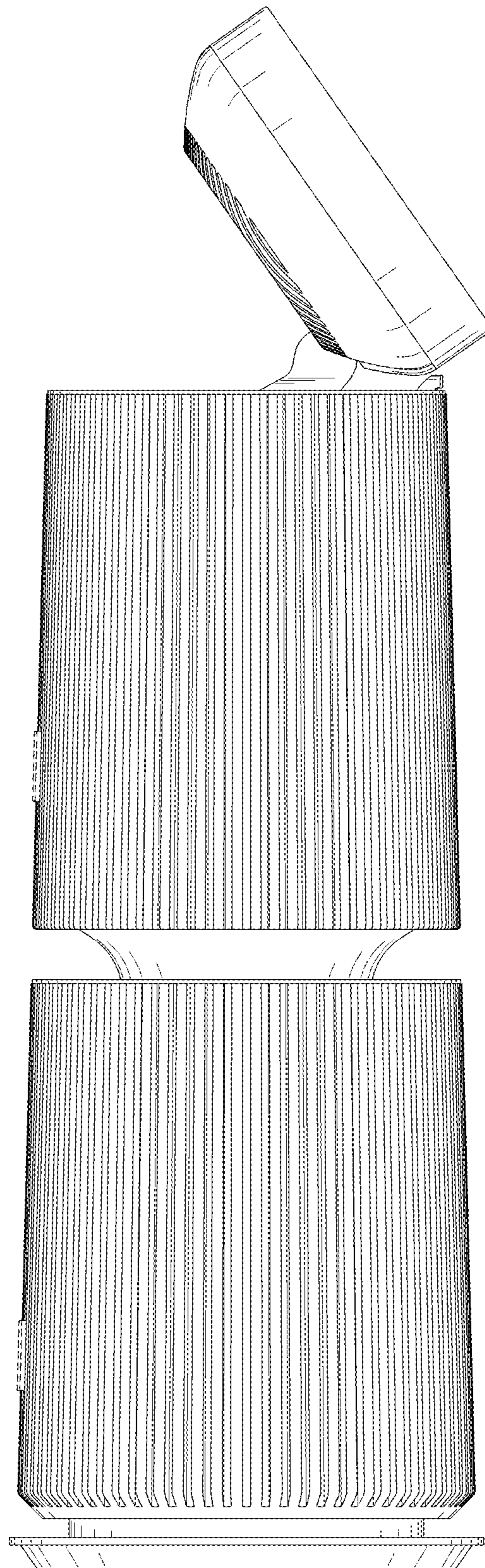

FIG. 12

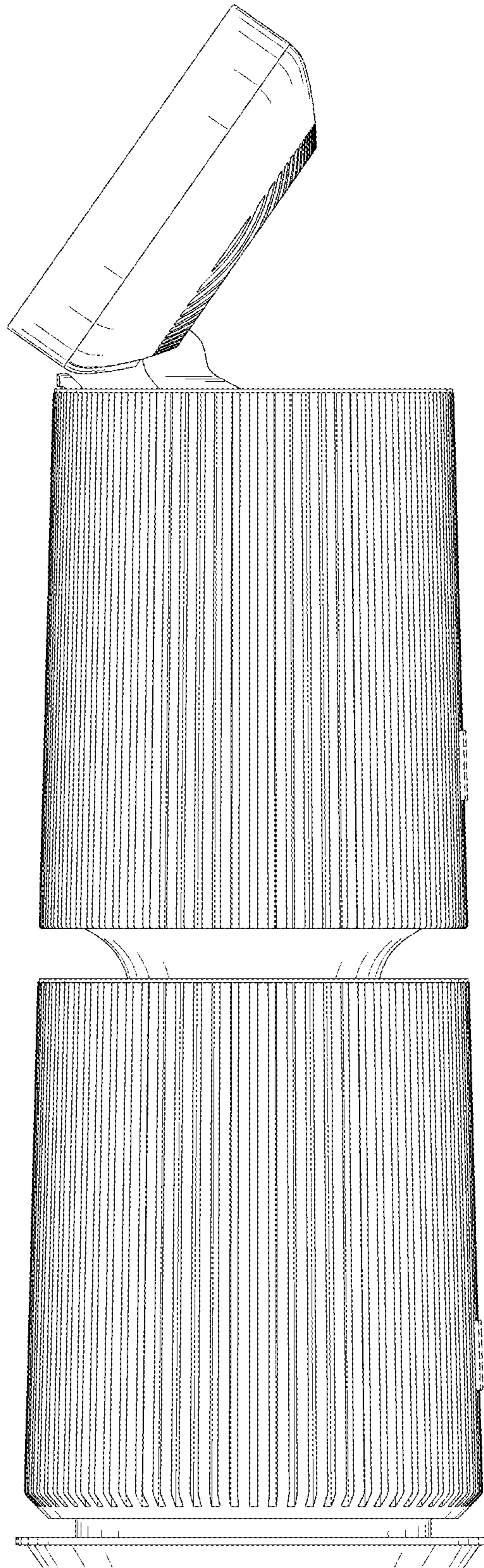

FIG. 13

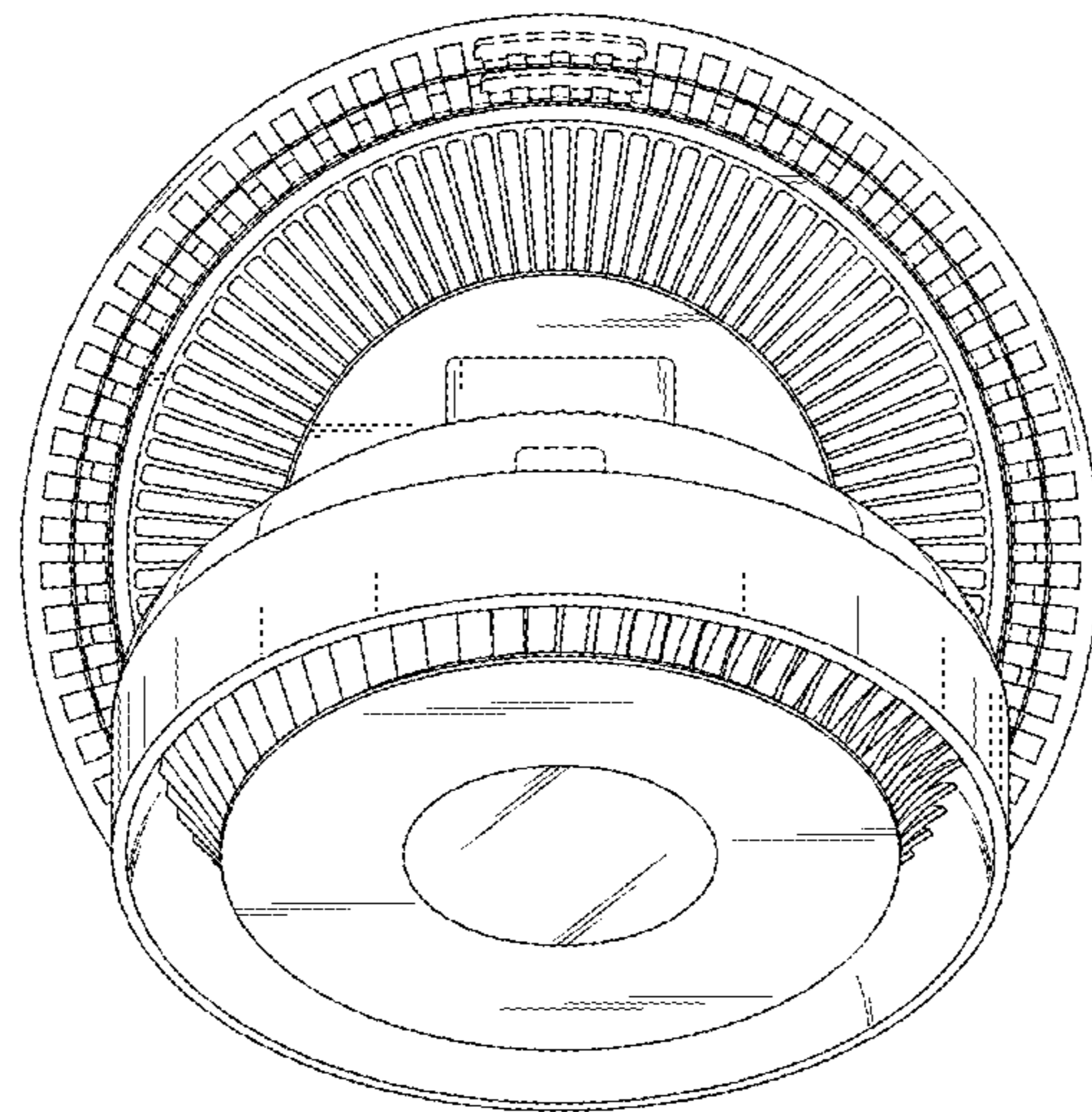

FIG. 14

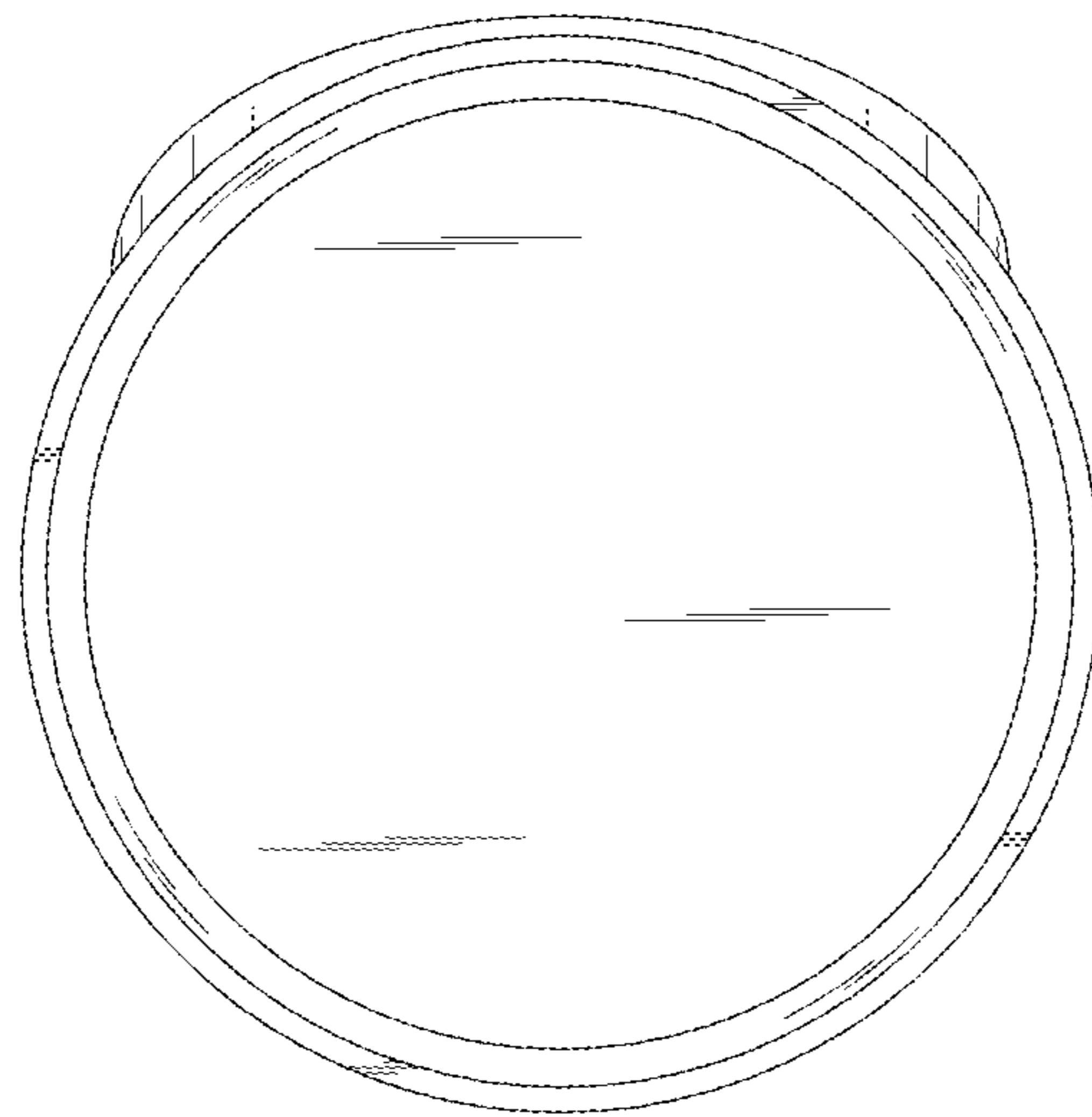

FIG. 15

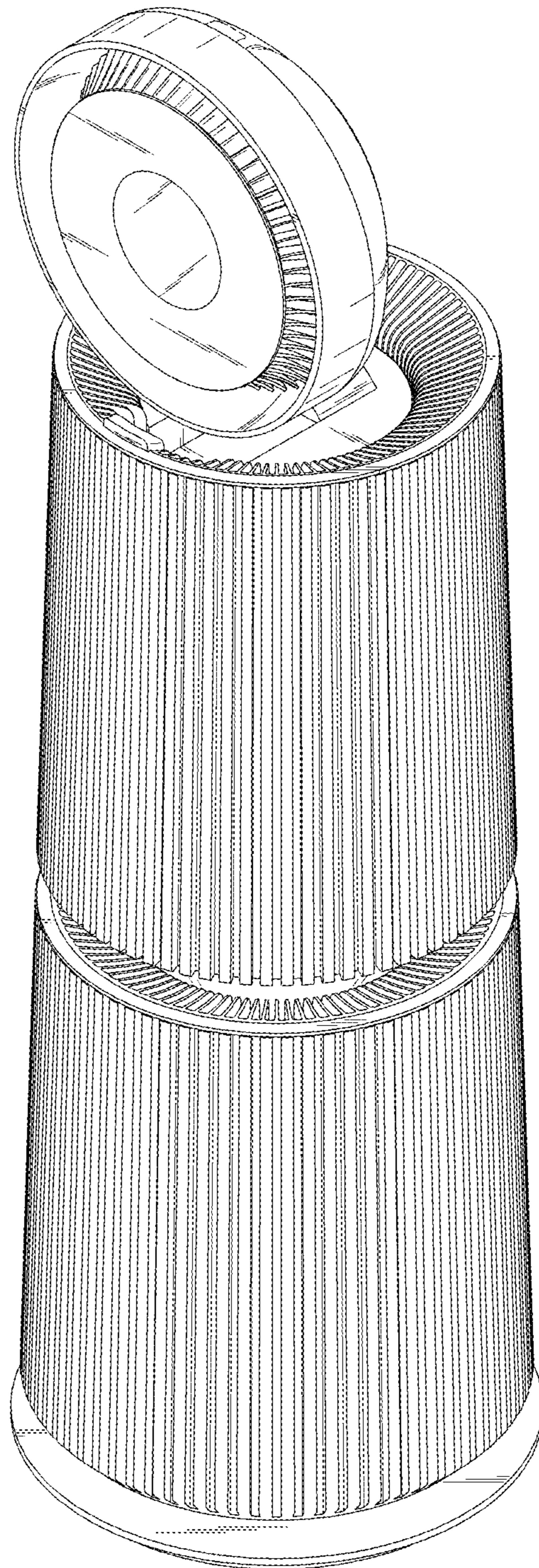

FIG. 16

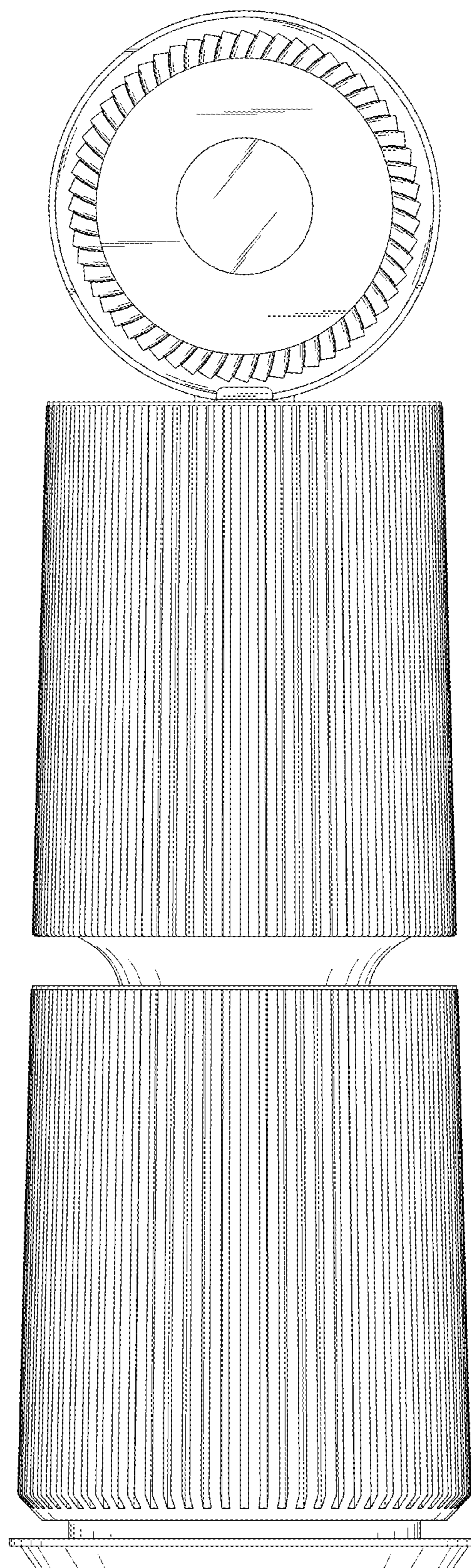

FIG. 17

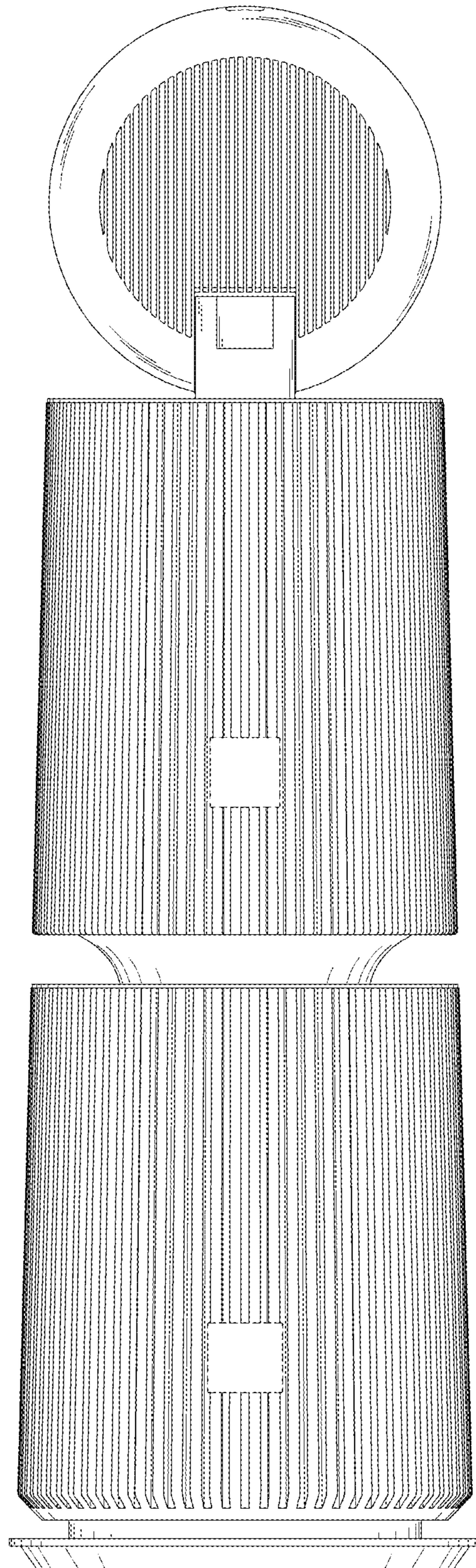

FIG. 18

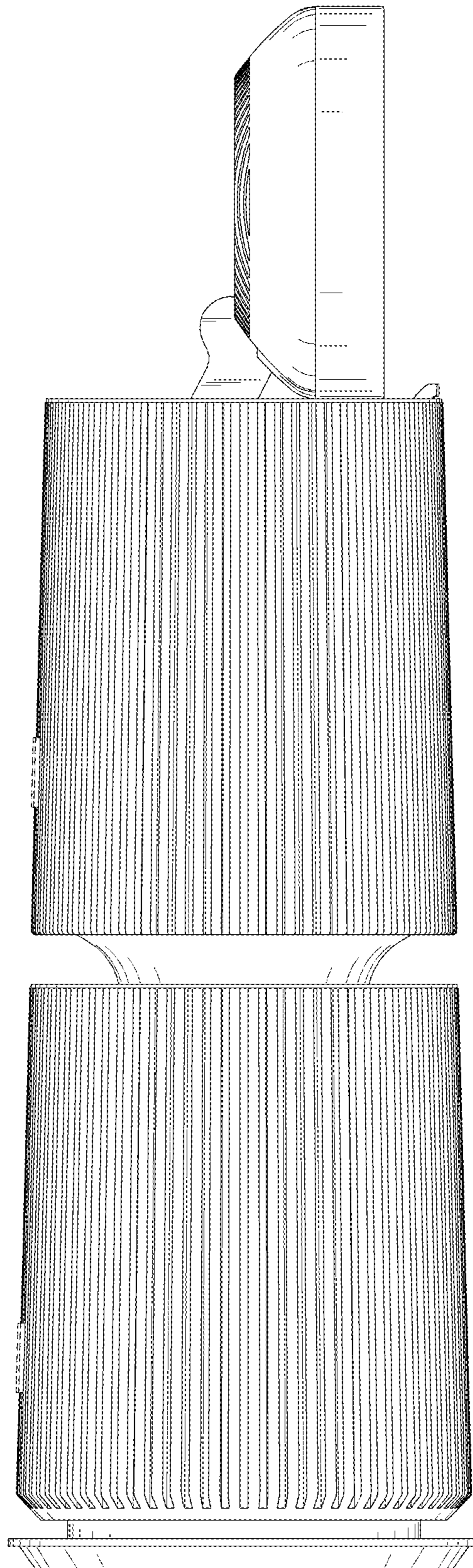

FIG. 19

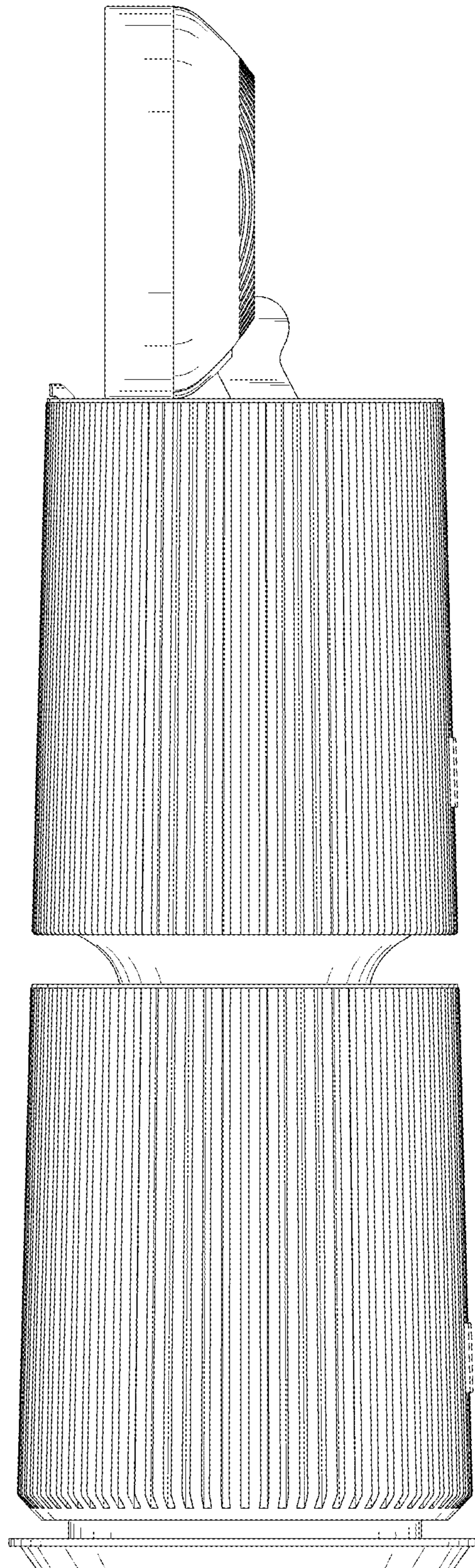

FIG. 20

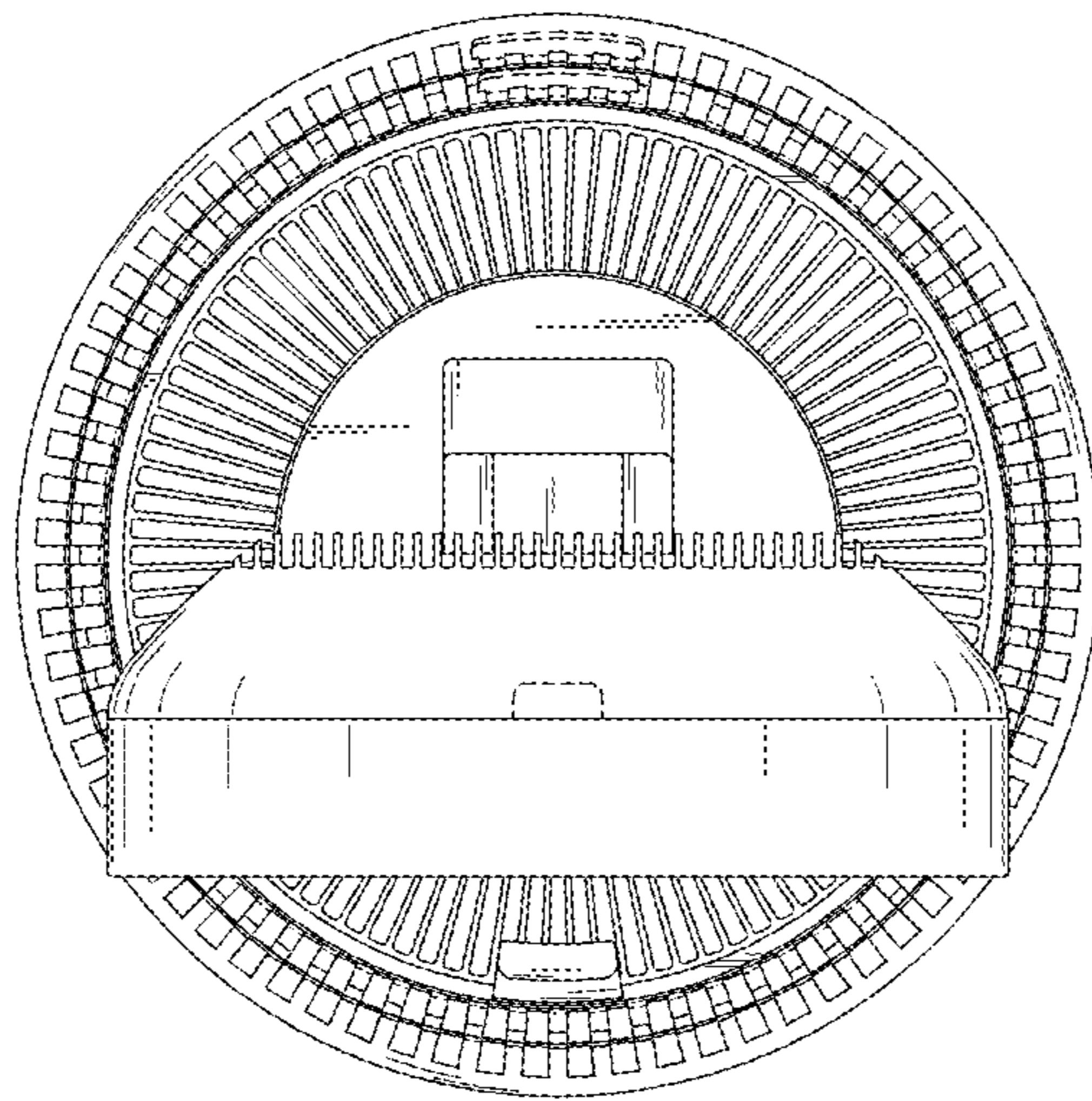

FIG. 21

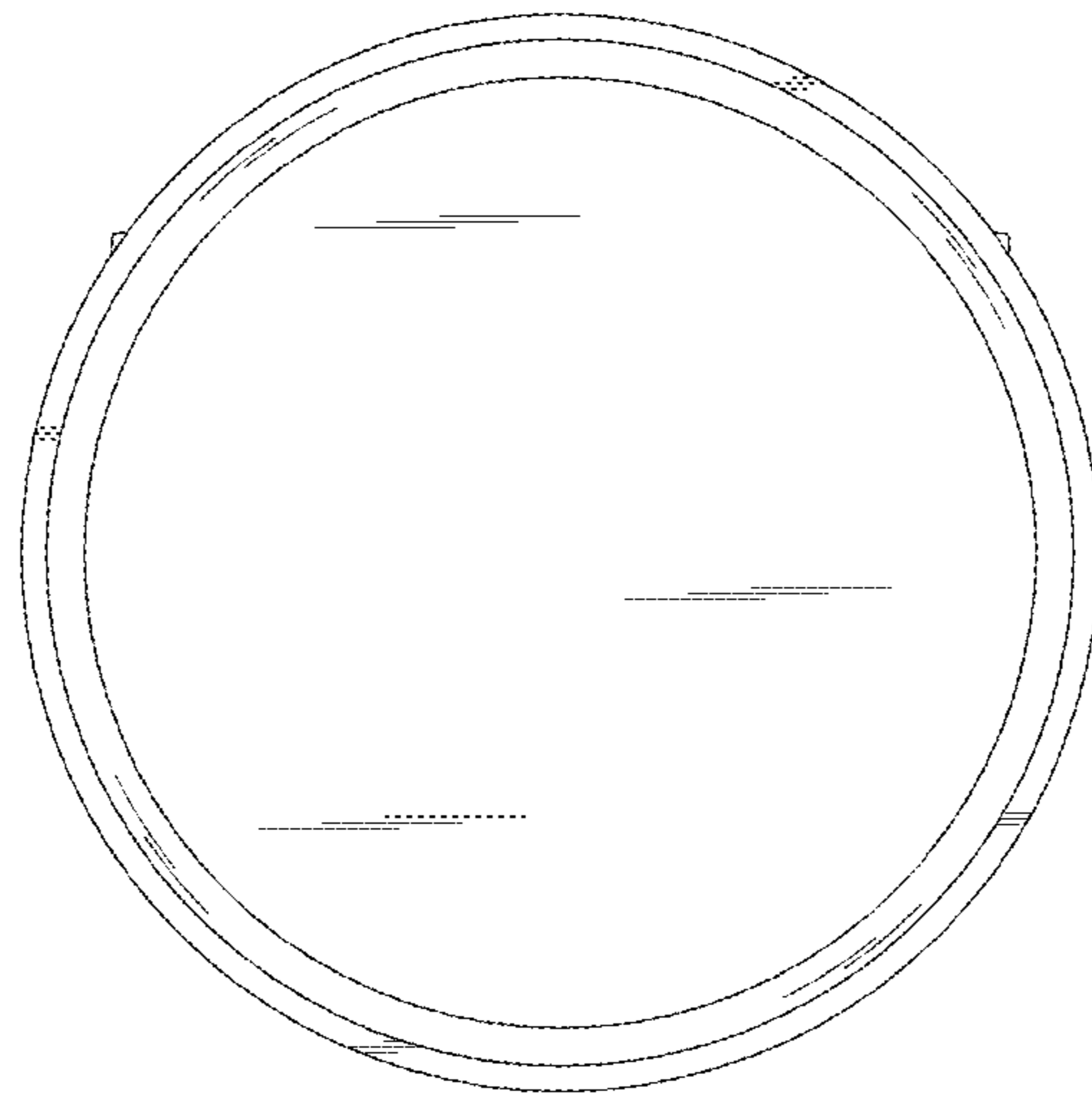

FIG. 22

