



US00D967218S

(12) **United States Design Patent** (10) **Patent No.:** **US D967,218 S**  
**Zhang** (45) **Date of Patent:** **\*\* Oct. 18, 2022**

(54) **VACUUM MACHINE**  
(71) Applicant: **Shishi Plastic Silk Trading Co., Ltd.,**  
Quanzhou (CN)  
(72) Inventor: **Bingbing Zhang,** Quanzhou (CN)  
(73) Assignee: **Shishi Plastic Silk Trading Co., Ltd.,**  
Quanzhou (CN)  
(\*\*) Term: **15 Years**  
(21) Appl. No.: **29/846,023**  
(22) Filed: **Jul. 12, 2022**  
(51) **LOC (13) Cl.** ..... **15-09**  
(52) **U.S. Cl.**  
USPC ..... **D15/146**  
(58) **Field of Classification Search**  
USPC ..... D15/145, 146; D18/50  
CPC ..... B65B 31/046; B65B 31/047  
See application file for complete search history.

D910,726 S \* 2/2021 Sun ..... D15/146  
D912,710 S \* 3/2021 Choi ..... D15/146  
D912,711 S \* 3/2021 Choi ..... D15/146  
D921,730 S \* 6/2021 Chen ..... D15/146  
D922,462 S \* 6/2021 Leyden ..... D15/146  
D926,399 S 7/2021 Luo  
D936,120 S \* 11/2021 Minibaev ..... D15/146  
D936,717 S \* 11/2021 Chen ..... D15/146  
D937,919 S \* 12/2021 Chen ..... D15/146  
D948,588 S \* 4/2022 Li ..... D15/146  
D956,117 S \* 6/2022 Huang ..... D15/146  
D957,491 S \* 7/2022 Li ..... D15/146  
D957,492 S \* 7/2022 Li ..... D15/146  
D960,949 S \* 8/2022 Gray ..... D15/146  
2005/0022480 A1 \* 2/2005 Brakes ..... B65B 31/046  
53/512

\* cited by examiner

*Primary Examiner* — Patricia A Palasik  
(74) *Attorney, Agent, or Firm* — Nitin Kaushik

(57) **CLAIM**

The ornamental design for a vacuum machine, as shown and described.

**DESCRIPTION**

FIG. 1 is a front perspective view of a vacuum machine, showing my new design;  
FIG. 2 is a front view thereof;  
FIG. 3 is a rear view thereof;  
FIG. 4 is a left side view thereof;  
FIG. 5 is a right side view thereof;  
FIG. 6 is a top view thereof; and,  
FIG. 7 is a bottom view thereof.  
The broken lines in the drawings illustrate the portions of the vacuum machine, which form no part of the claimed design.

**1 Claim, 7 Drawing Sheets**

(56) **References Cited**

**U.S. PATENT DOCUMENTS**

D527,182 S \* 8/2006 Ham ..... D3/274  
7,540,127 B2 \* 6/2009 Sung ..... B65B 31/047  
53/434  
D633,118 S \* 2/2011 Beatty ..... D15/146  
D682,834 S \* 5/2013 Ishikawa ..... D14/422  
D694,794 S \* 12/2013 Cumming ..... D15/146  
D706,269 S \* 6/2014 Qian ..... D14/422  
D763,334 S \* 8/2016 Yoshitomi ..... D15/146  
D823,913 S \* 7/2018 Chou ..... D15/146  
D884,208 S \* 5/2020 Xie ..... D24/217  
D905,772 S \* 12/2020 Li ..... D15/146  
D910,100 S \* 2/2021 Qiu ..... D15/146

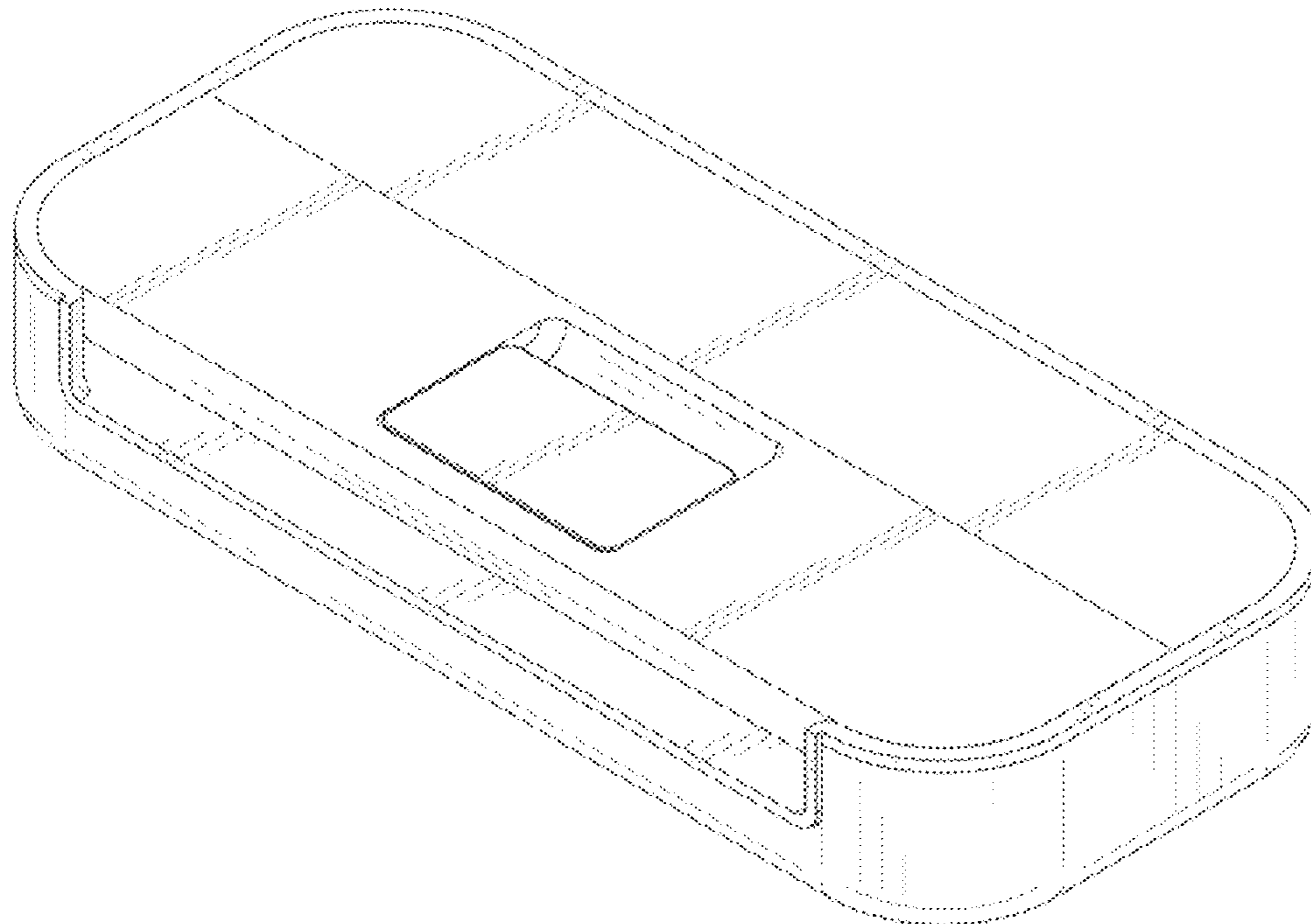

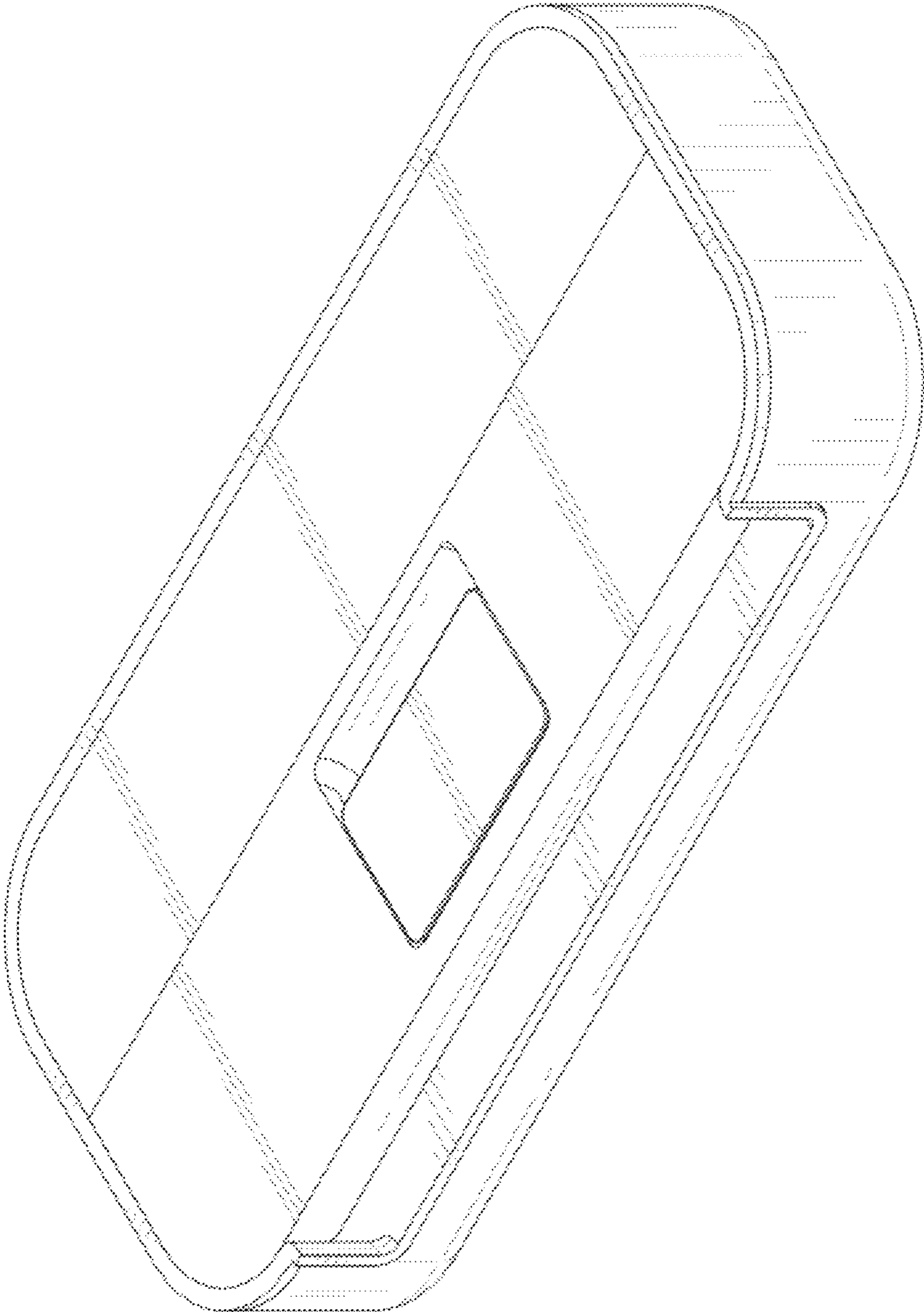
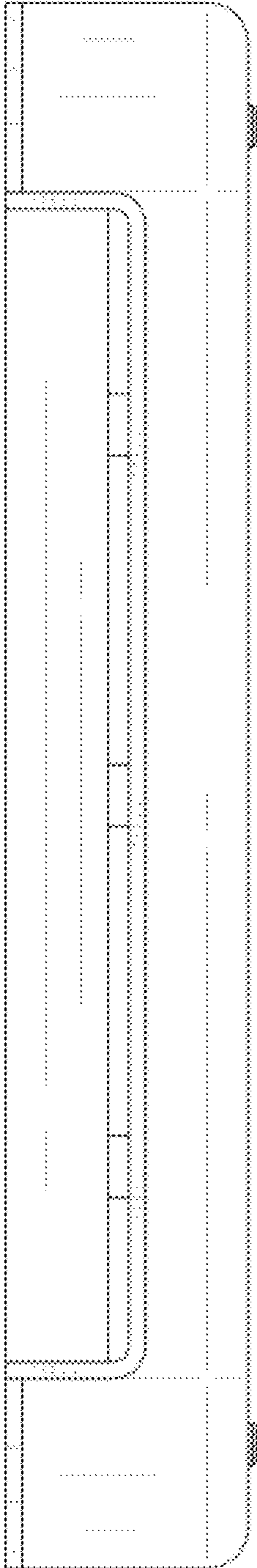

FIG. 1



**FIG. 2**

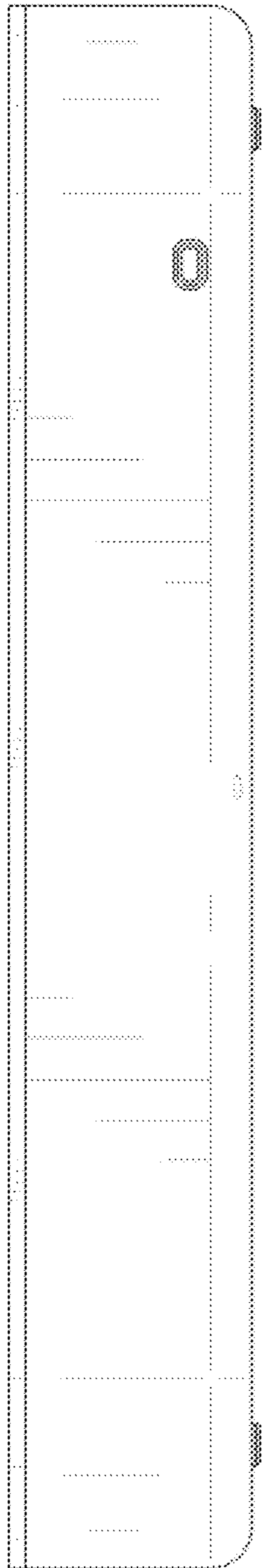

FIG. 3

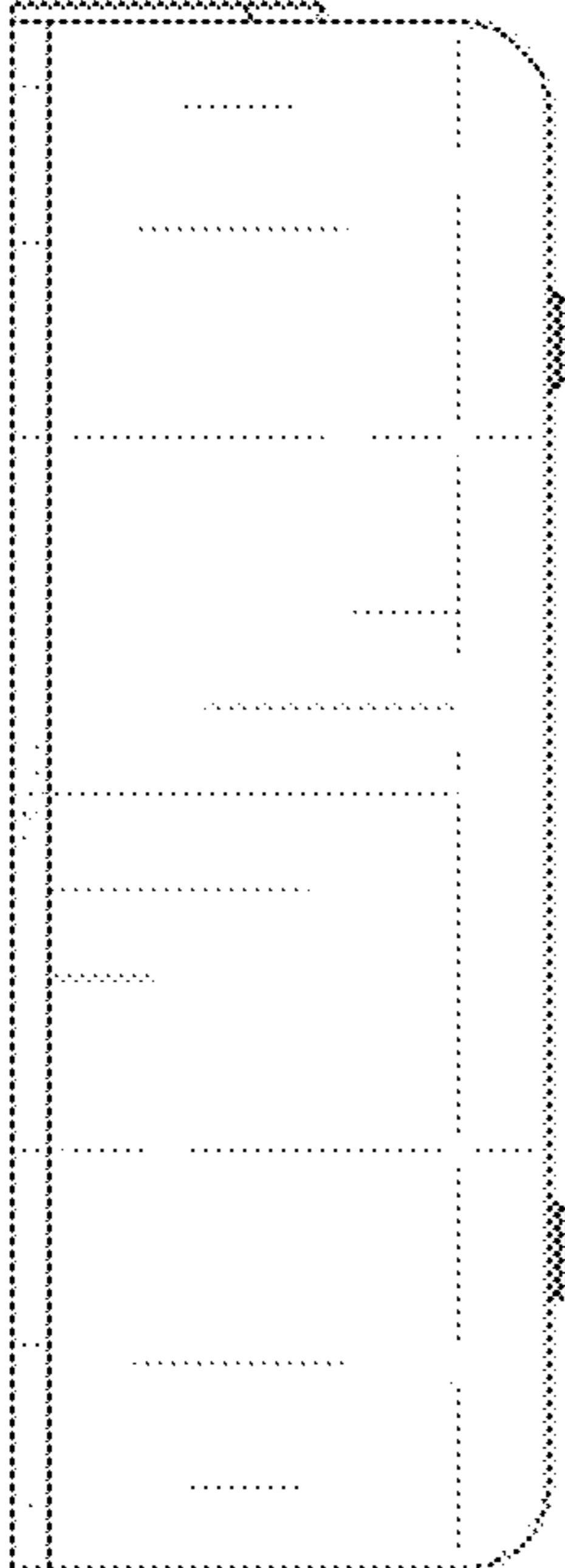

FIG. 4

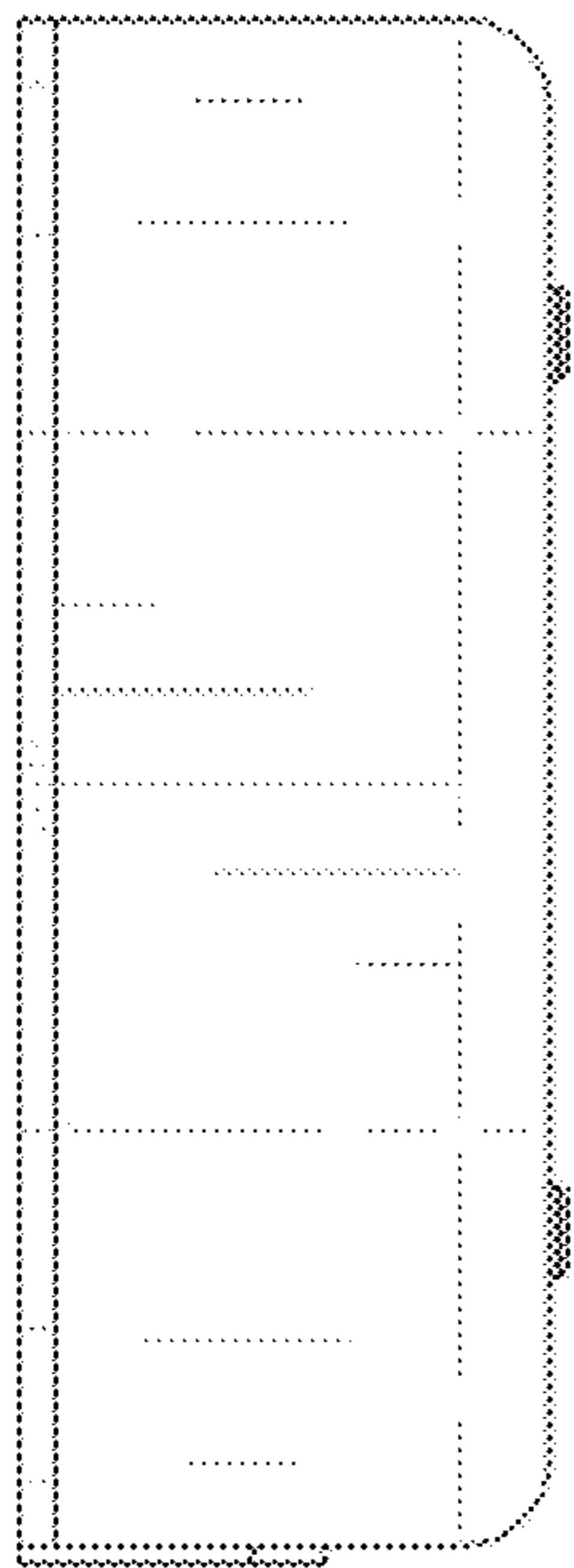

FIG. 5

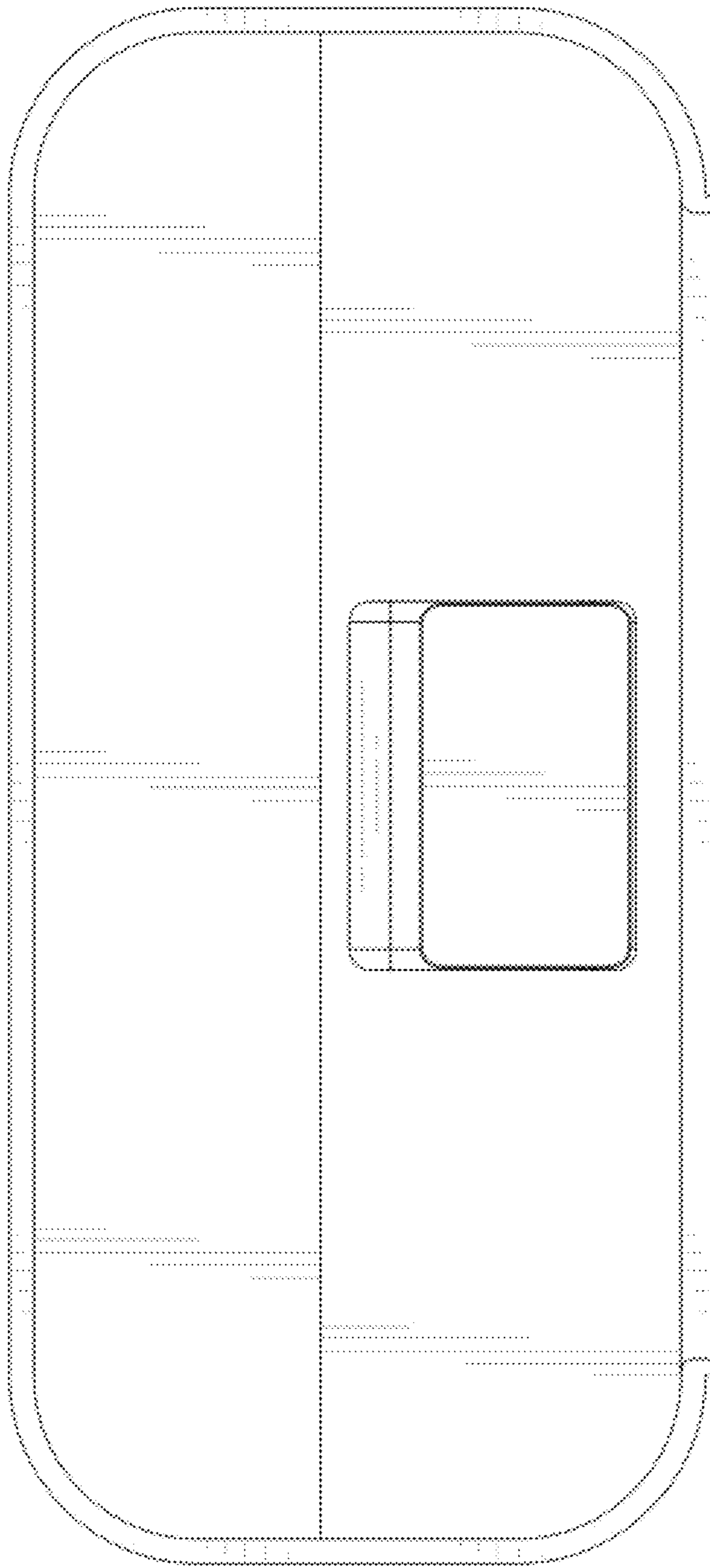

FIG. 6

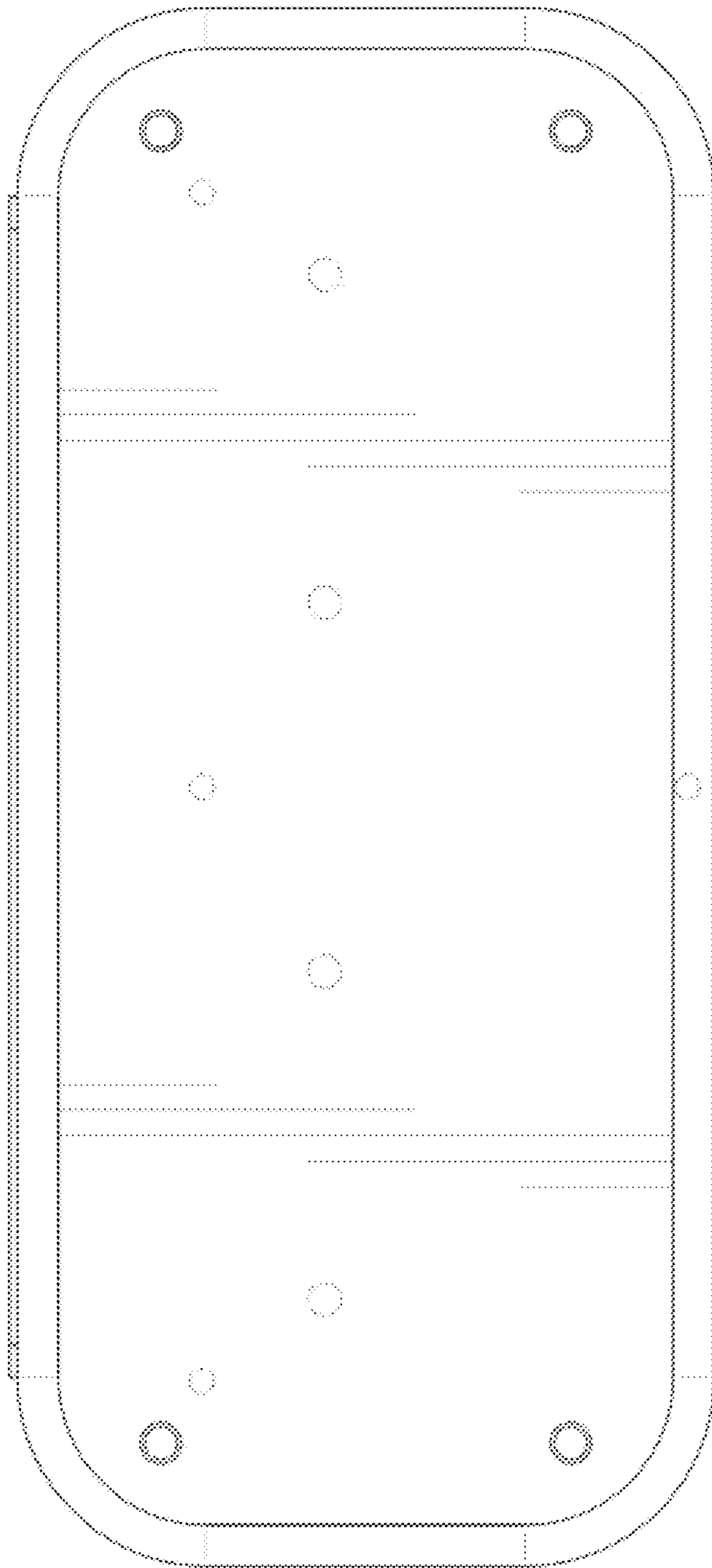

FIG. 7