



US00D967093S

(12) **United States Design Patent**
Bae et al.

(10) **Patent No.:** **US D967,093 S**

(45) **Date of Patent:** **** *Oct. 18, 2022**

(54) **ELECTRONIC CANVAS**

(71) Applicant: **LG ELECTRONICS INC.**, Seoul (KR)

(72) Inventors: **Jinwan Bae**, Seoul (KR); **Hyojin Won**, Seoul (KR); **Minjeong Kang**, Seoul (KR); **Youngjoon Park**, Seoul (KR); **Youjin Lee**, Seoul (KR)

(73) Assignee: **LG ELECTRONICS INC.**, Seoul (KR)

(*) Notice: This patent is subject to a terminal disclaimer.

(**) Term: **15 Years**

(21) Appl. No.: **29/735,202**

(22) Filed: **May 19, 2020**

(30) **Foreign Application Priority Data**

Dec. 17, 2019 (KR) 30-2019-0061364

(51) **LOC (13) Cl.** **14-02**

(52) **U.S. Cl.**
USPC **D14/375**; D14/203.8

(58) **Field of Classification Search**

USPC D14/305, 306, 307, 315, 316, 322, 334, D14/335, 336, 339, 340, 356, 371, 372, D14/373, 374, 375, 376, 377, 378, 379, D14/380, 381, 382, 432, 448, 449, 450, D14/451, 452, 125, 126, 127, 129, 132, D14/133, 217, 239, 314, 337, 447, 203.1, D14/203.3, 203.7, 203.8, 159; D19/113, D19/114, 91; D20/21, 41, 42; D6/300, D6/308, 310, 311, 312, 313, 314

CPC G06F 1/16; G06F 1/1601; G06F 1/1603; G06F 1/1605; G06F 1/1607; G06F 1/1611; G06F 1/1616; G06F 1/1618; G06F 1/1622; G06F 1/1626; G06F 1/1641; G06F 1/1643; G06F 1/1647; G06F 1/1649; G06F 1/1654; G06F

1/1656; G06F 1/181; G06F 1/1684; G06F 1/1686; G06F 1/1692; H05K 5/00; H05K 5/03; H05K 5/0243; H05K 5/0286; H05K 5/0239; H05K 5/02; H05K 5/0204; H05K 5/0217; H05K 5/0247; H05K 5/0234; H05K 5/0213; H04N 5/64; H04N 5/645

See application file for complete search history.

(56) **References Cited**

U.S. PATENT DOCUMENTS

D730,353 S * 5/2015 Hwangbo D14/374
D732,037 S * 6/2015 Wylie D14/434
D738,879 S * 9/2015 Hwangbo D14/374

(Continued)

OTHER PUBLICATIONS

Google Jamboard. Google, youtube.com (online) 4 pages. Posted May 23, 2017. [Retrieved Apr. 13, 202] <https://www.youtube.com/watch?v=eVLQa-L-Lw> (Year: 2017).*

(Continued)

Primary Examiner — Kathleen L Jones

Assistant Examiner — Cole Sanders Holman

(74) *Attorney, Agent, or Firm* — Birch, Stewart, Kolasch & Birch, LLP

(57) **CLAIM**

We claim the ornamental design for an electronic canvas, as shown and described.

DESCRIPTION

FIG. 1 is a perspective view of an electronic canvas showing the new design;

FIG. 2 is a front elevation view thereof;

FIG. 3 is a rear elevation view thereof;

FIG. 4 is a left-side elevation view thereof;

FIG. 5 is a right-side elevation view thereof;

FIG. 6 is a top plan view thereof; and,

FIG. 7 is a bottom plan view thereof.

1 Claim, 7 Drawing Sheets

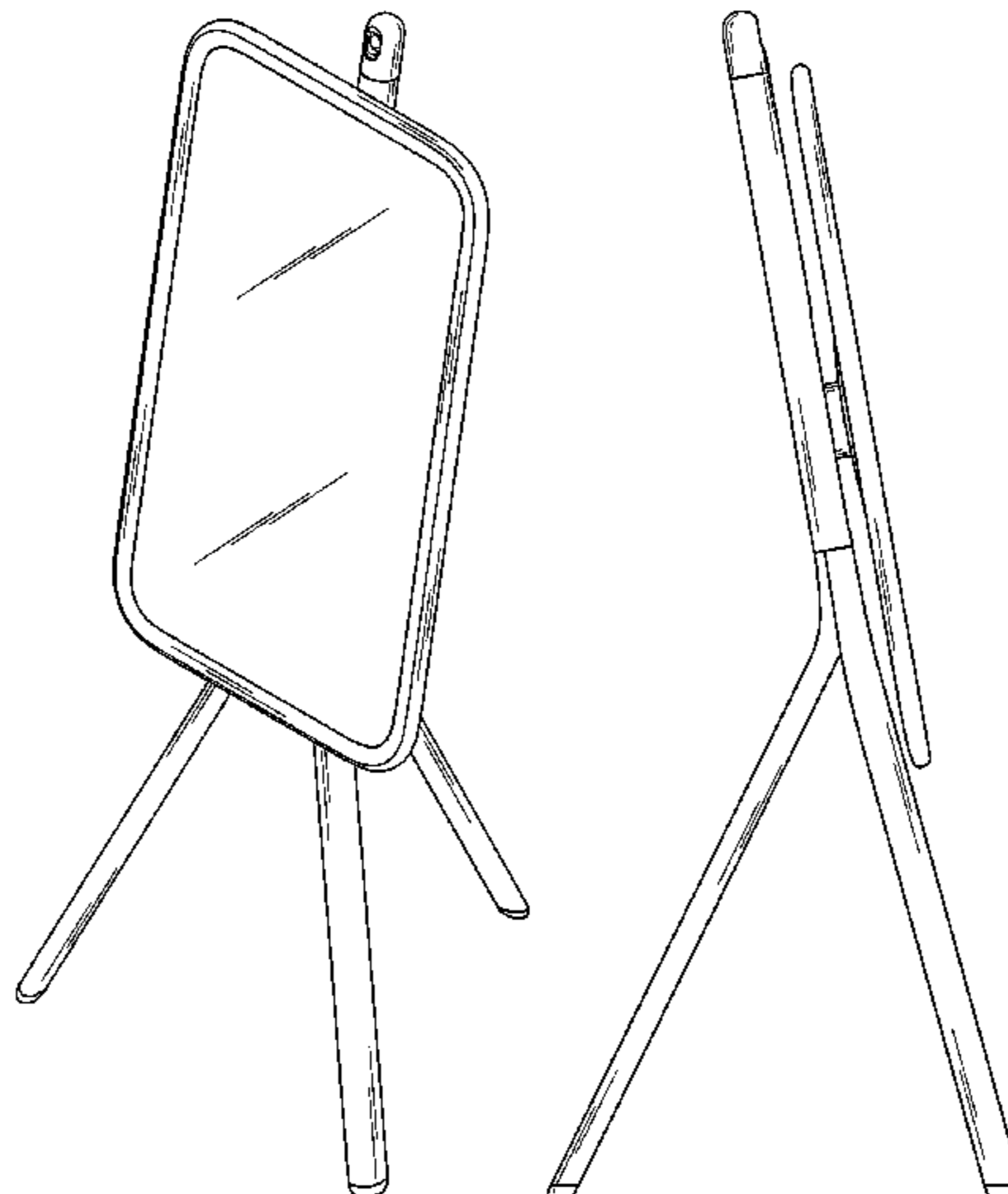

(56)

References Cited

U.S. PATENT DOCUMENTS

D766,879 S * 9/2016 Park D14/224
D791,121 S * 7/2017 Collins D14/341
D864,296 S * 10/2019 Park D19/113
D881,883 S * 4/2020 Germe D14/375
D882,570 S * 4/2020 Germe D14/375
D913,370 S * 3/2021 Hwang D19/114
D925,239 S * 7/2021 Cai D6/312
D939,628 S * 12/2021 Hyun G06F 3/044
D19/114
D941,288 S * 1/2022 Bhat D14/336
2020/0081483 A1* 3/2020 Laurent F16M 11/041
2020/0409410 A1* 12/2020 Kawaguchi G06F 1/1605
2021/0318722 A1* 10/2021 Lee G09F 19/02

OTHER PUBLICATIONS

Samsung Flip Review. Samsung, youtube.com (online) 5 pages.
Posted Apr. 12, 2018. [Retrieved Apr. 13, 2021] <https://www.youtube.com/watch?v=gcKMC7ro1Cw> (Year: 2018).*

* cited by examiner

FIG. 1

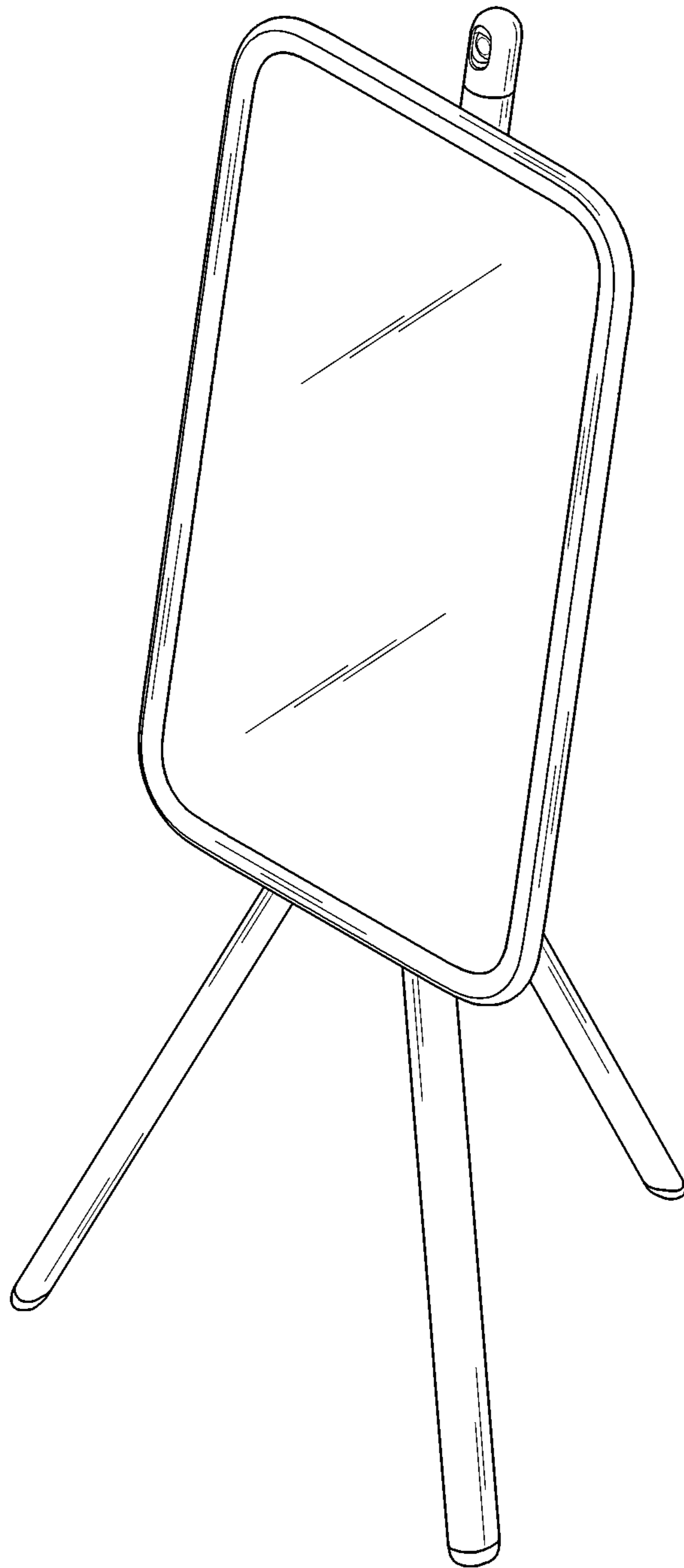

FIG. 2

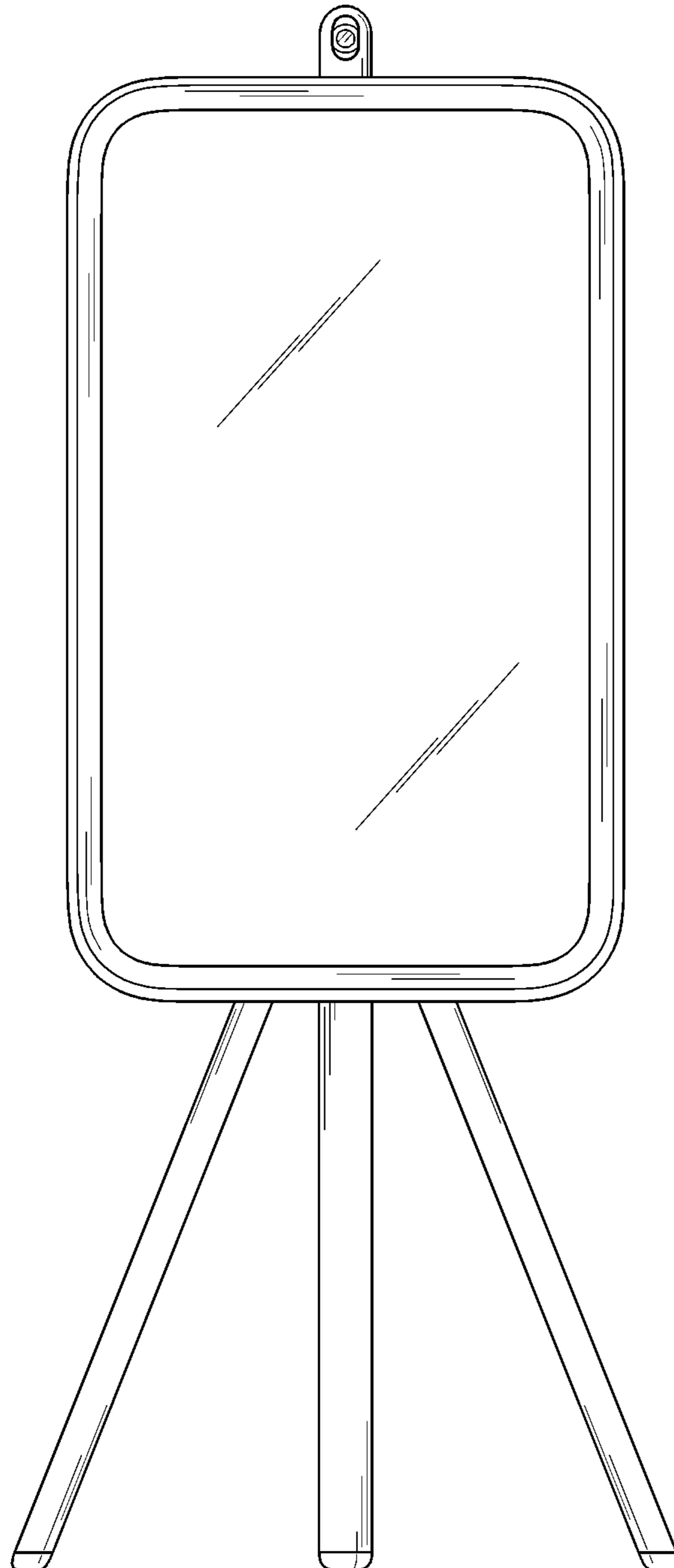

FIG. 3

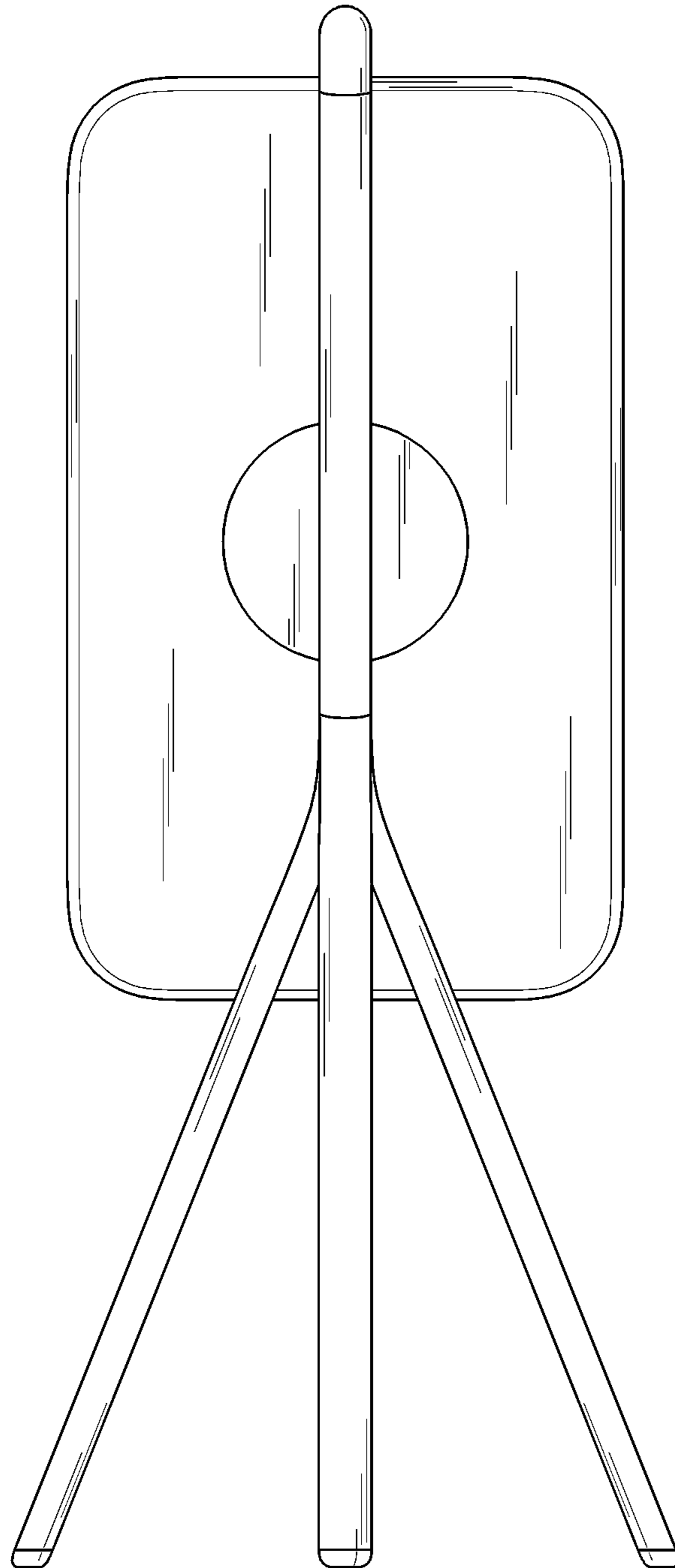

FIG. 4

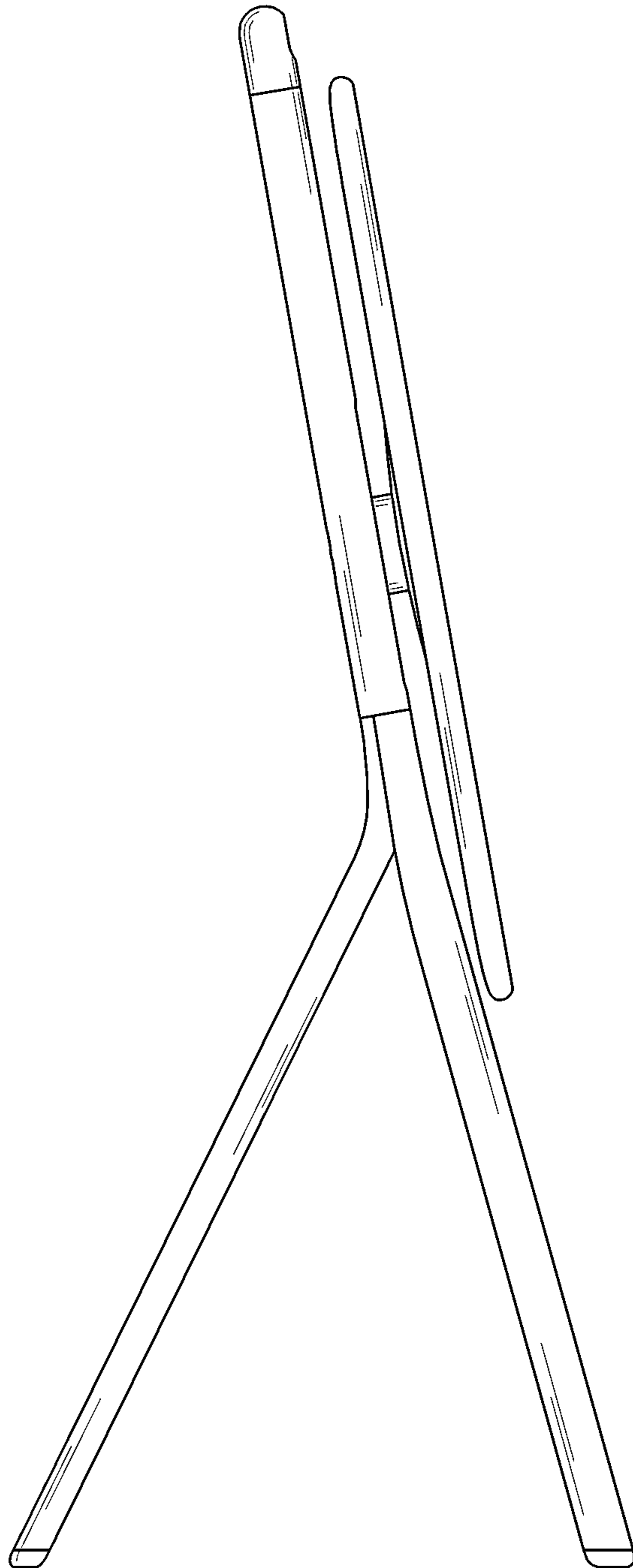

FIG. 5

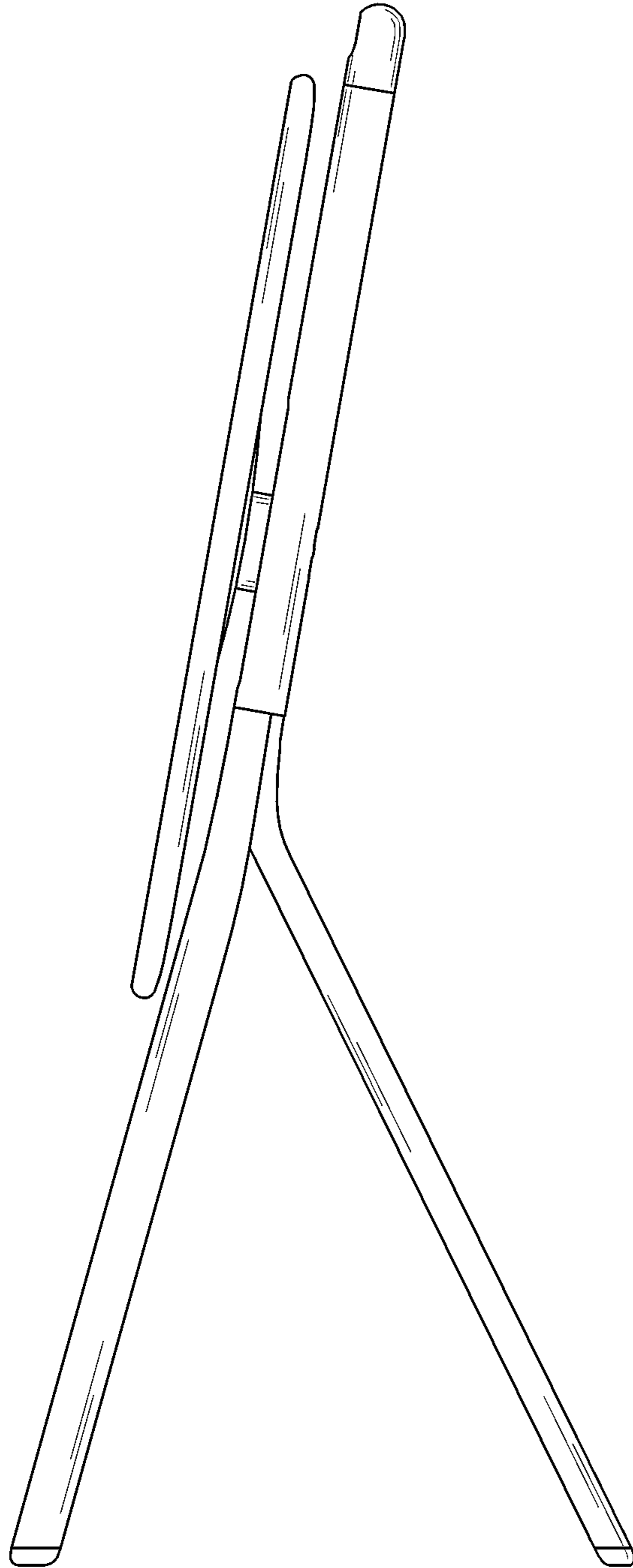

FIG. 6

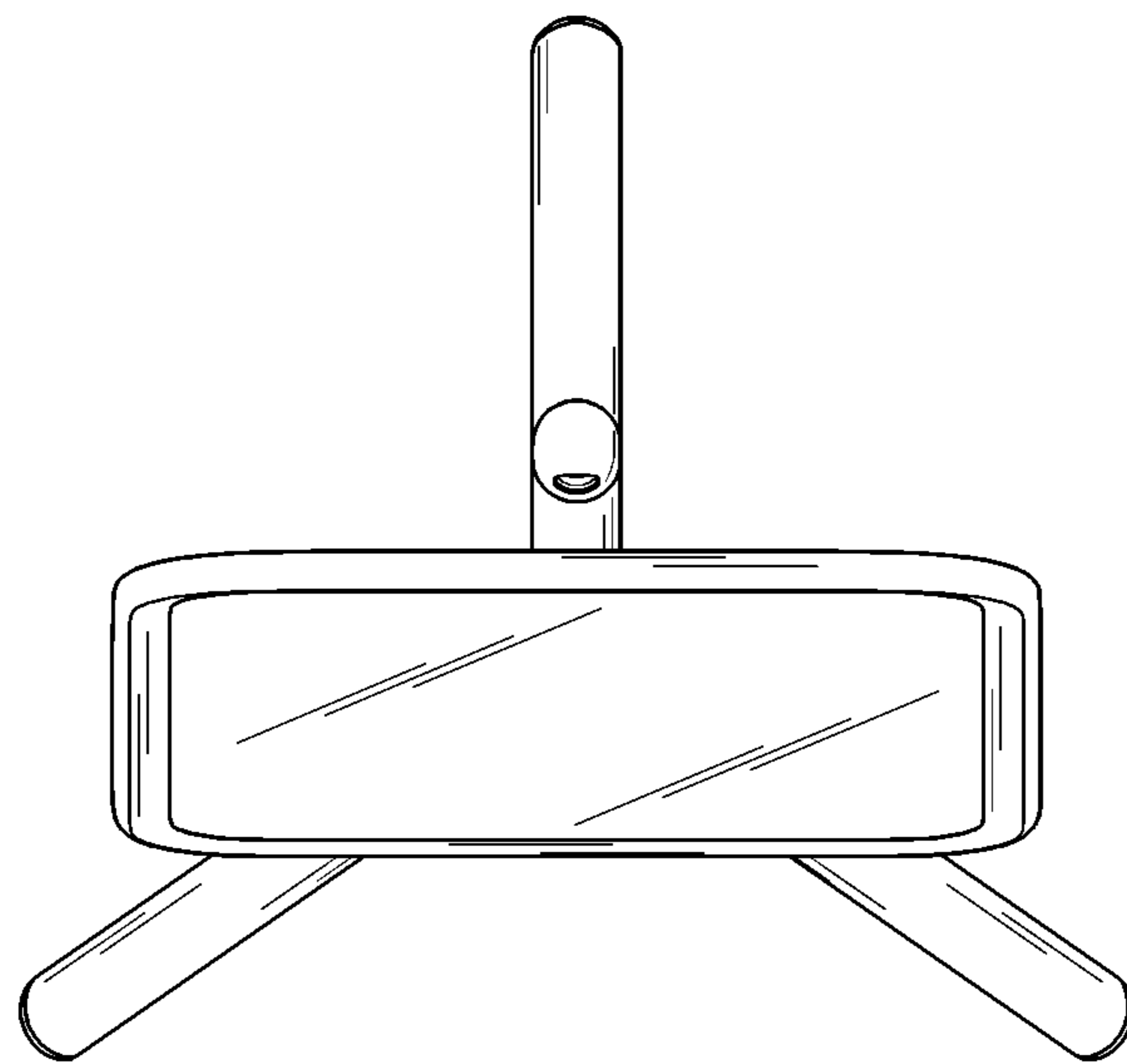

FIG. 7

