

US00D966983S

(12) **United States Design Patent**
Shida et al.

(10) **Patent No.:** **US D966,983 S**

(45) **Date of Patent:** **** Oct. 18, 2022**

(54) **WHEEL FOR A MOTOR VEHICLE**

(71) Applicant: **MAZDA MOTOR CORPORATION,**
Hiroshima (JP)

(72) Inventors: **Yuichiro Shida,** Hiroshima (JP); **Tetsuo Suginuma,** Hiroshima (JP)

(73) Assignee: **MAZDA MOTOR CORPORATION,**
Hiroshima (JP)

(**) Term: **15 Years**

(21) Appl. No.: **29/730,961**

(22) Filed: **Apr. 9, 2020**

(51) **LOC (13) Cl.** **12-16**

(52) **U.S. Cl.**
USPC **D12/209**

(58) **Field of Classification Search**
USPC D12/204–213; D21/563
CPC B60B 7/00; B60B 7/02; B60B 7/04; B60B 7/01; B60B 7/06; B60B 3/02; B60B 3/04; B60B 3/06; B60B 3/10; B60B 1/00; B60B 1/08; B60B 1/10; B60B 1/12
See application file for complete search history.

(56) **References Cited**

U.S. PATENT DOCUMENTS

D672,702 S	*	12/2012	Pollmann	D12/211
D791,039 S		7/2017	Rueckheim		
D791,671 S	*	7/2017	Bucher	D12/211
D794,528 S	*	8/2017	Setter	D12/211
D796,410 S	*	9/2017	Churchill	D12/211
D855,535 S	*	8/2019	Badstuebner	D12/209
D858,416 S	*	9/2019	Dewitt	D12/211

D861,570 S	*	10/2019	Bjerke	D12/211
D862,353 S	*	10/2019	Bjerke	D12/209
D874,377 S	*	2/2020	Lemke	D12/209
D883,888 S	*	5/2020	Daniel	D12/209
D890,066 S	*	7/2020	Metros	D12/209
D895,517 S	*	9/2020	Badstuebner	D12/209
D899,993 S	*	10/2020	Davidson	D12/209
D899,997 S	*	10/2020	Glover	D12/209
D915,979 S	*	4/2021	Shida	D12/209
D924,774 S	*	7/2021	Bernardi	D12/211
D940,627 S	*	1/2022	Bjerke	D12/209

* cited by examiner

Primary Examiner — Calvin E Vansant

(74) *Attorney, Agent, or Firm* — Studebaker & Brackett PC

(57) **CLAIM**

The ornamental design for a wheel for a motor vehicle, as shown and described.

DESCRIPTION

FIG. 1 is a first perspective view of a wheel for a motor vehicle;
FIG. 2 is a second perspective view thereof;
FIG. 3 is a front view thereof;
FIG. 4 is a left side view thereof;
FIG. 5 is a right side view thereof;
FIG. 6 is a top view thereof; and,
FIG. 7 is a bottom view thereof.

1 Claim, 4 Drawing Sheets

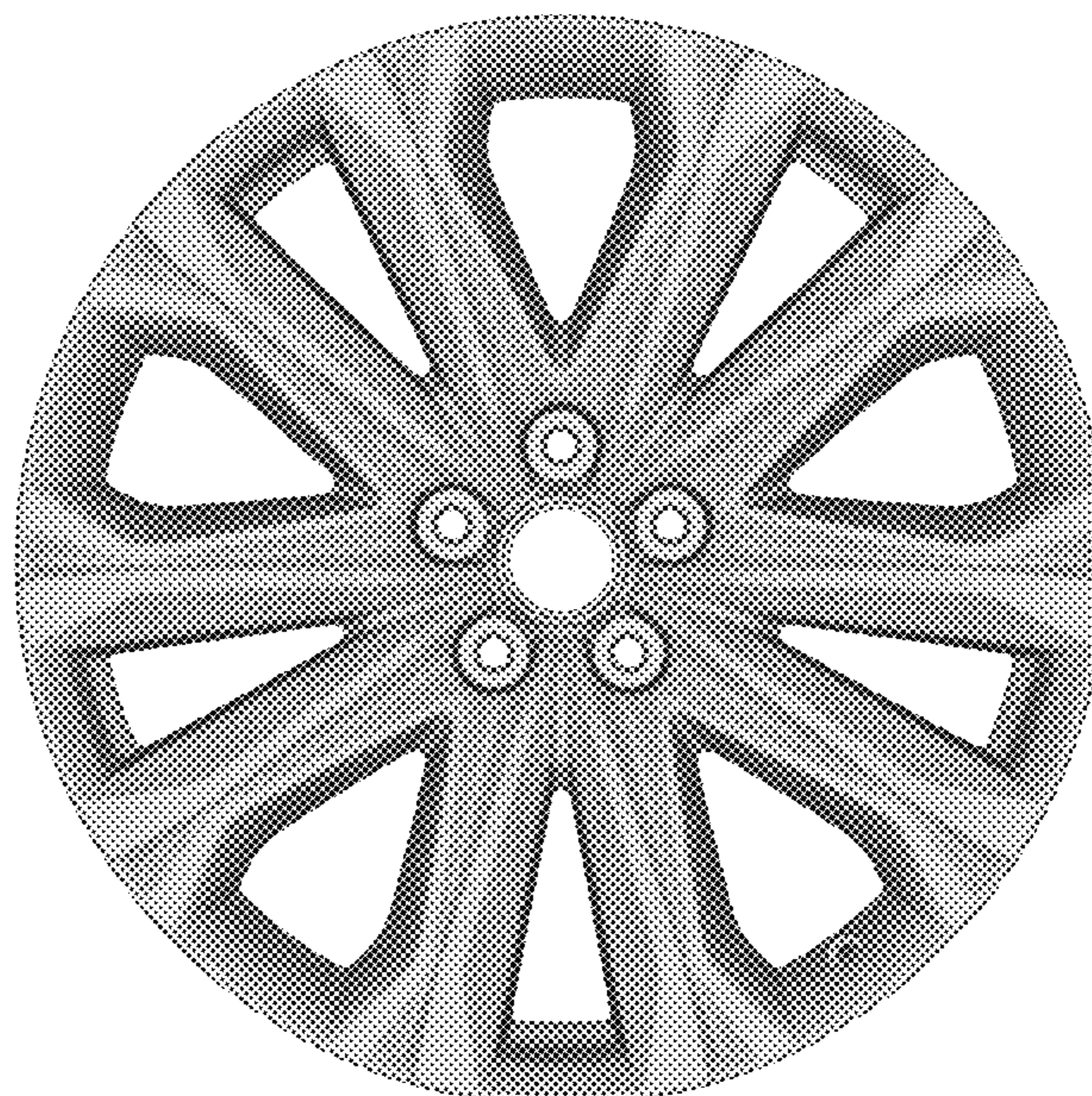
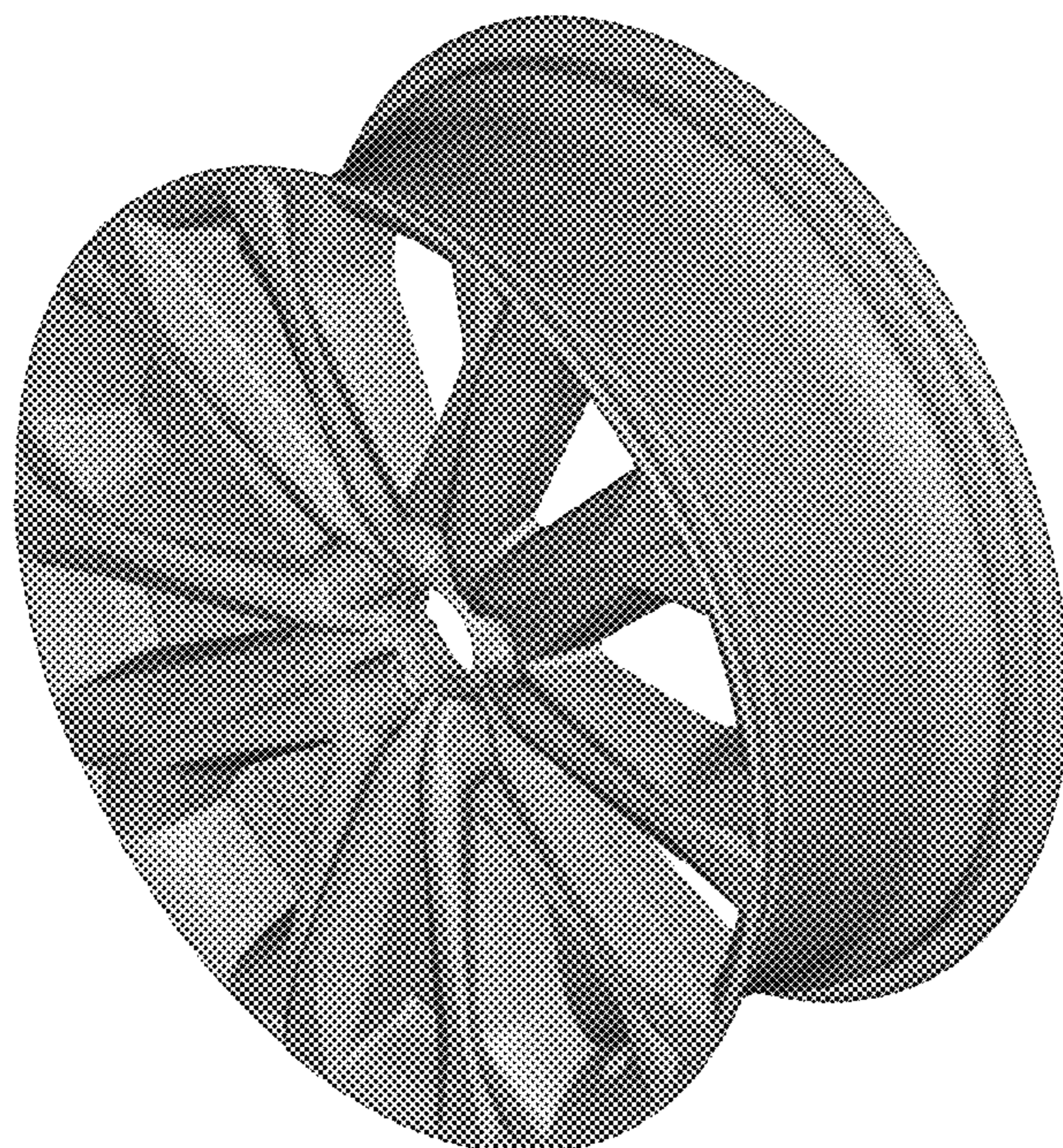

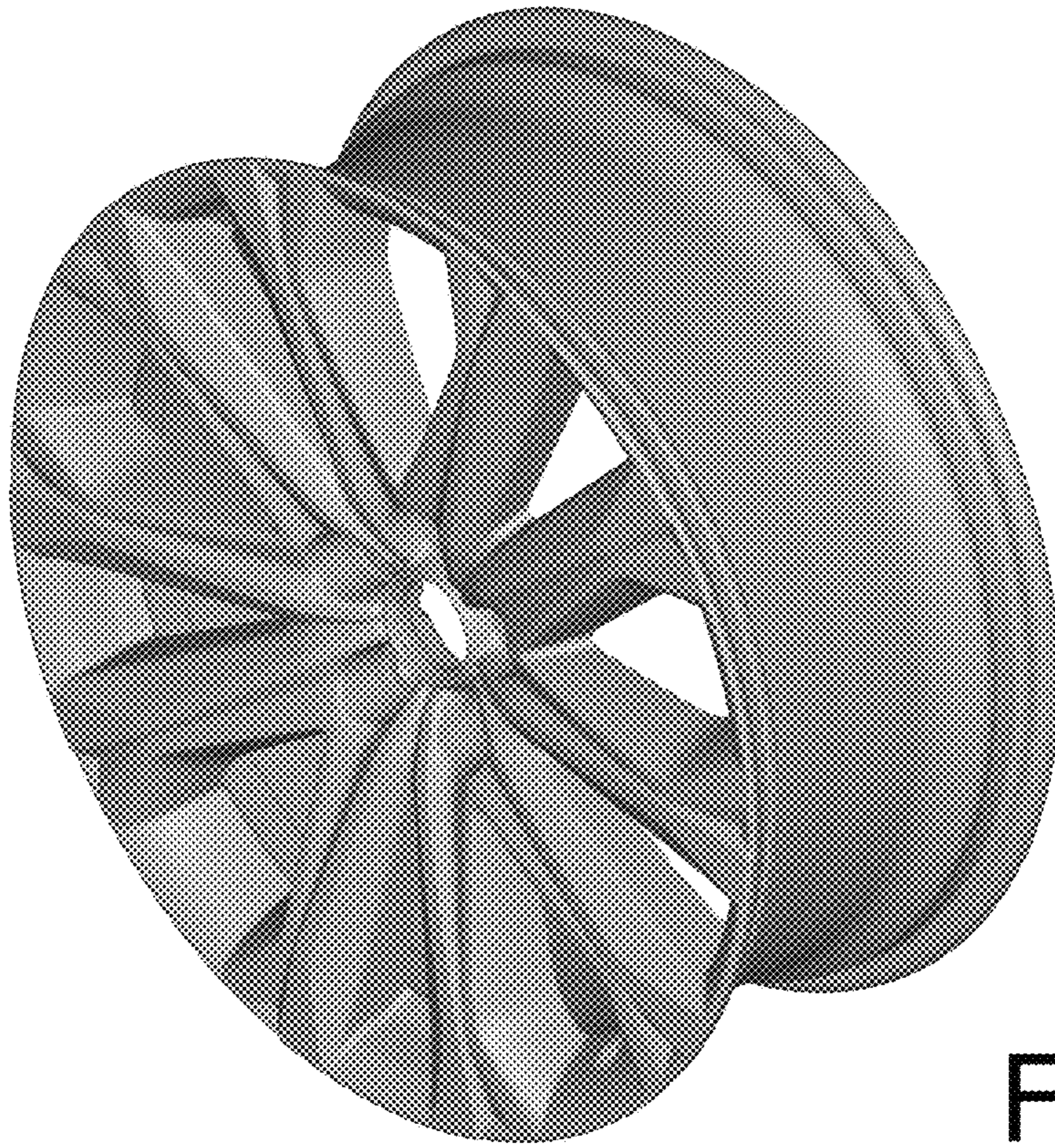

FIG. 1

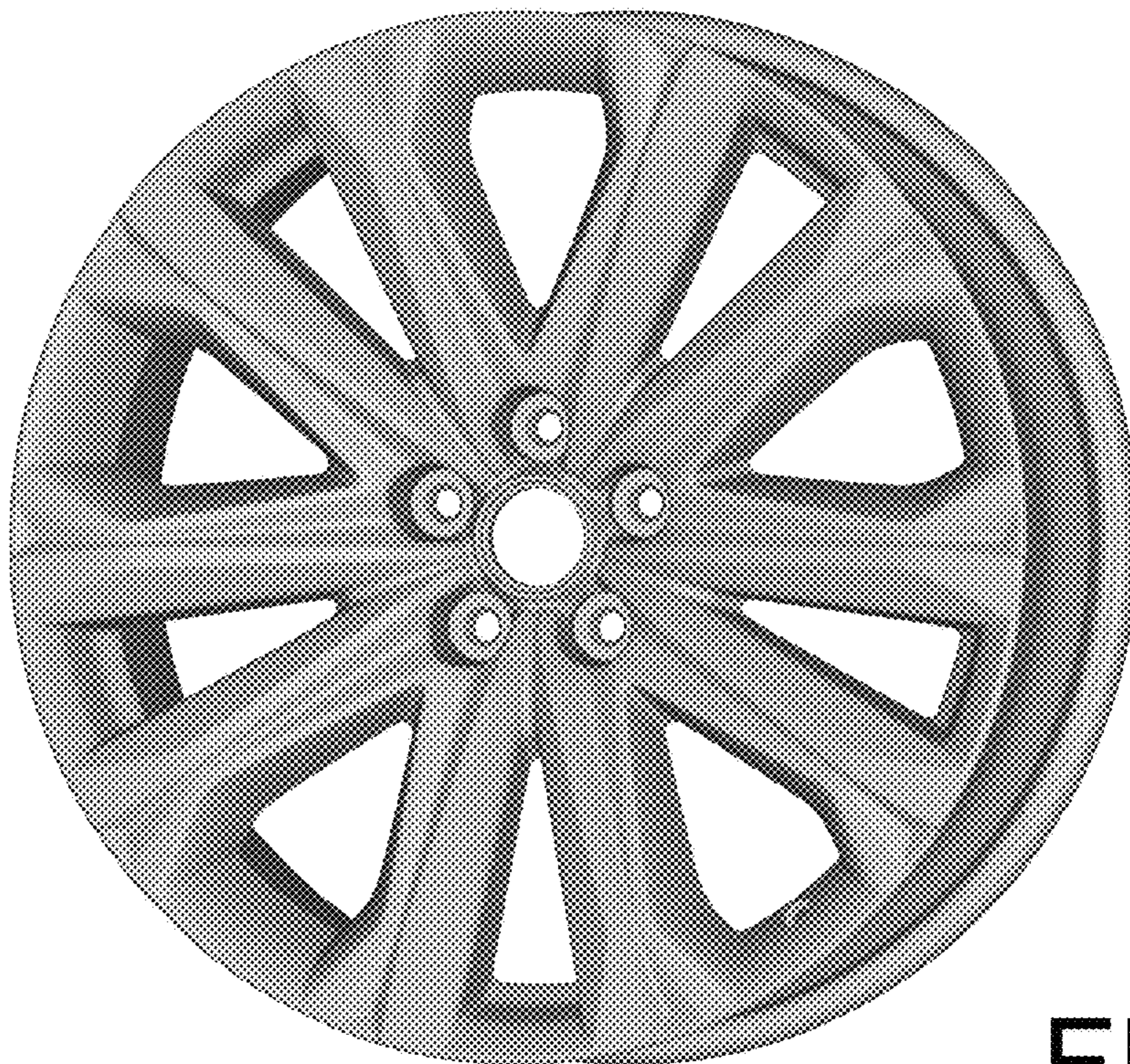

FIG. 2

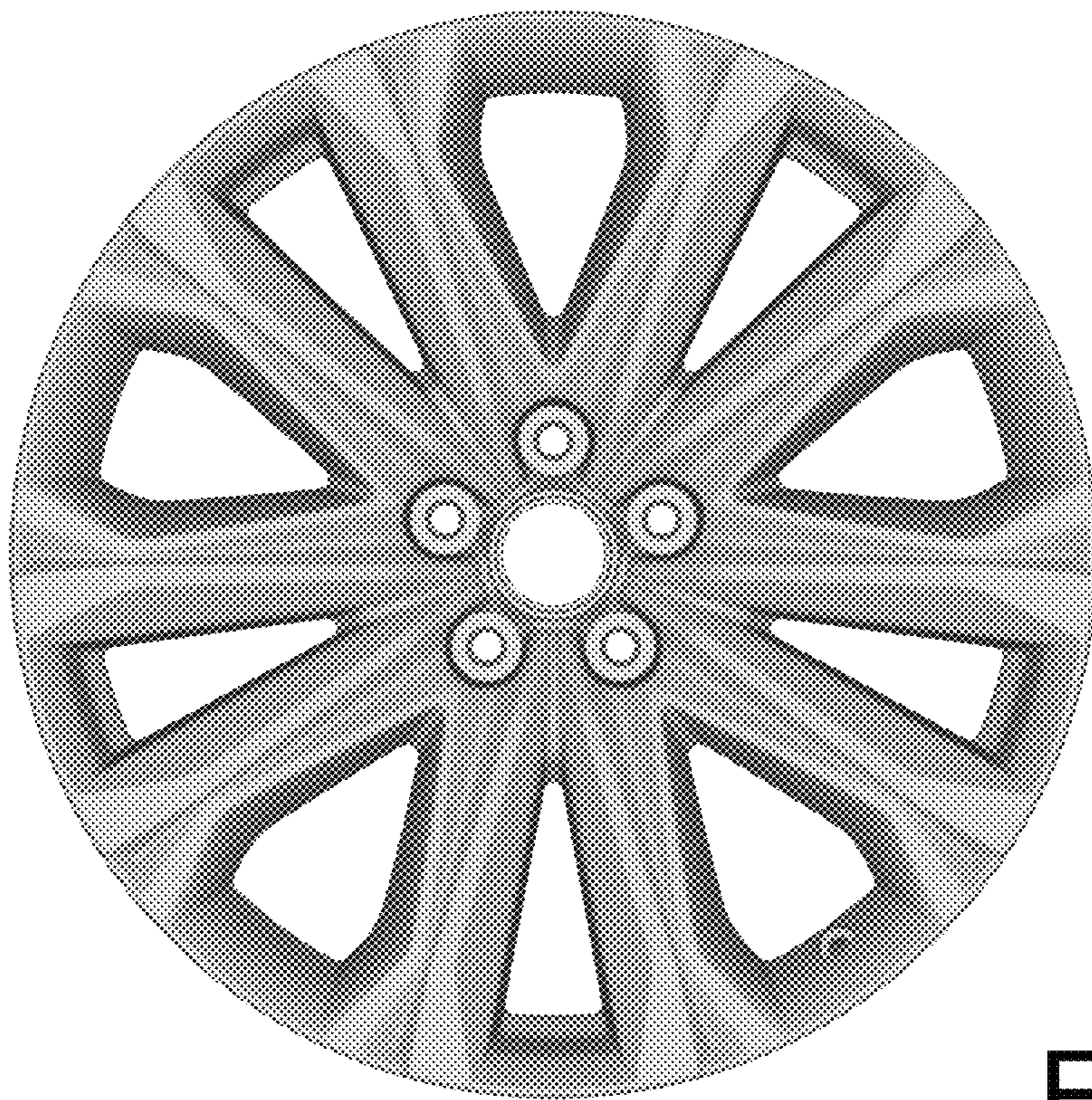

FIG.3

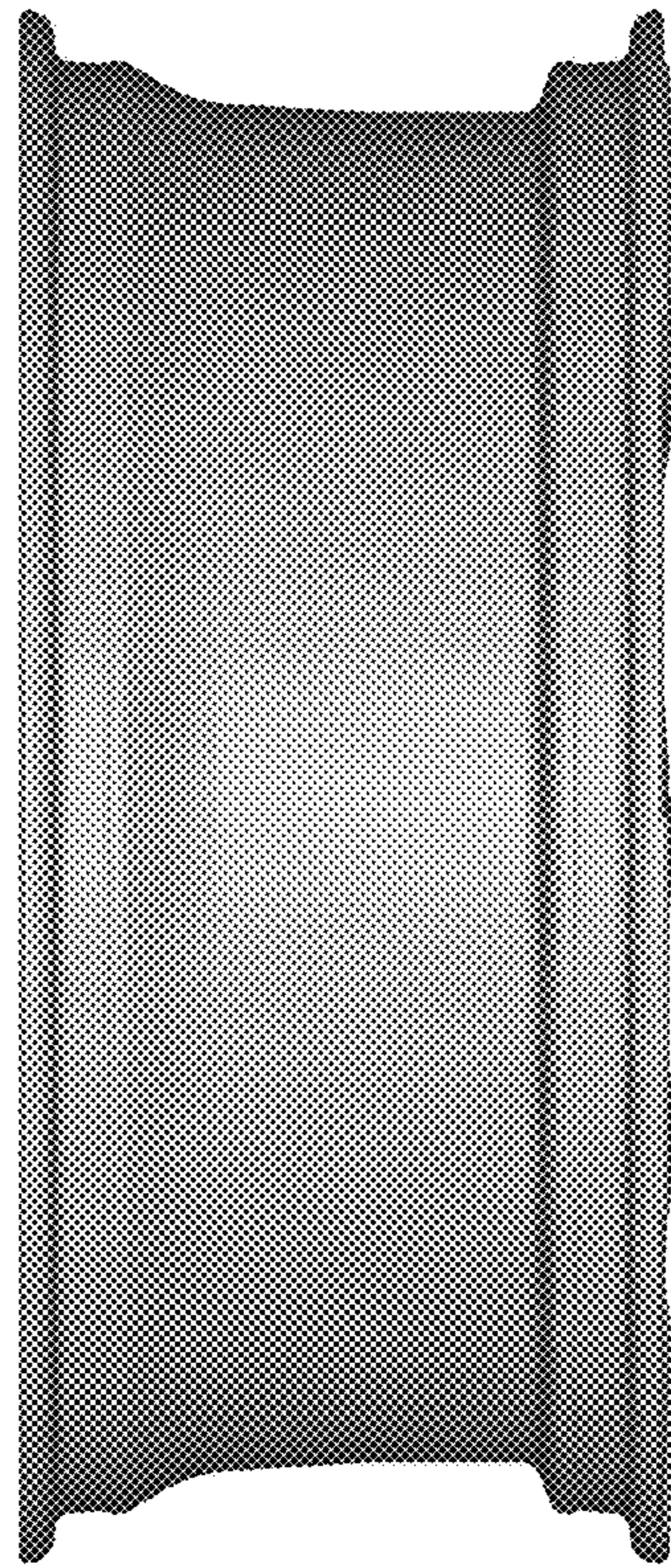

FIG.4

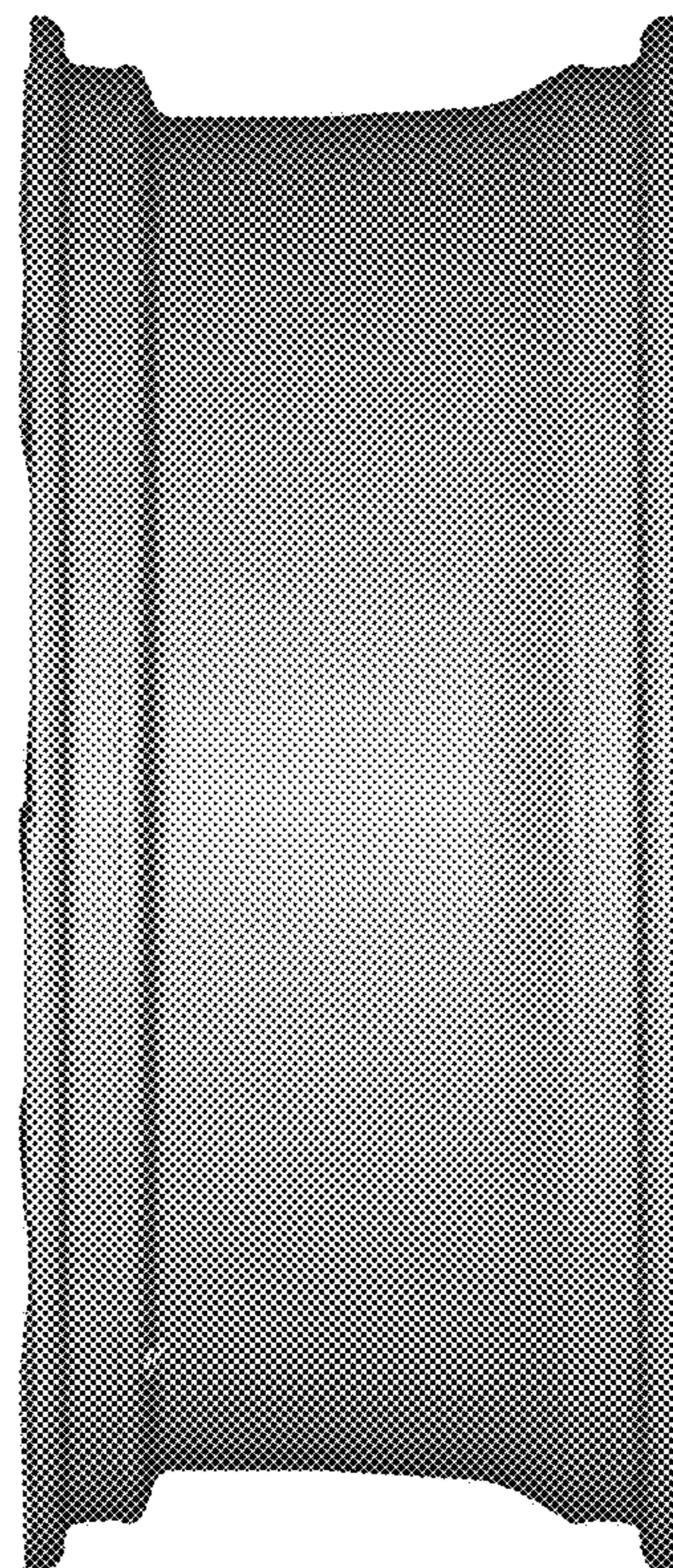

FIG.5

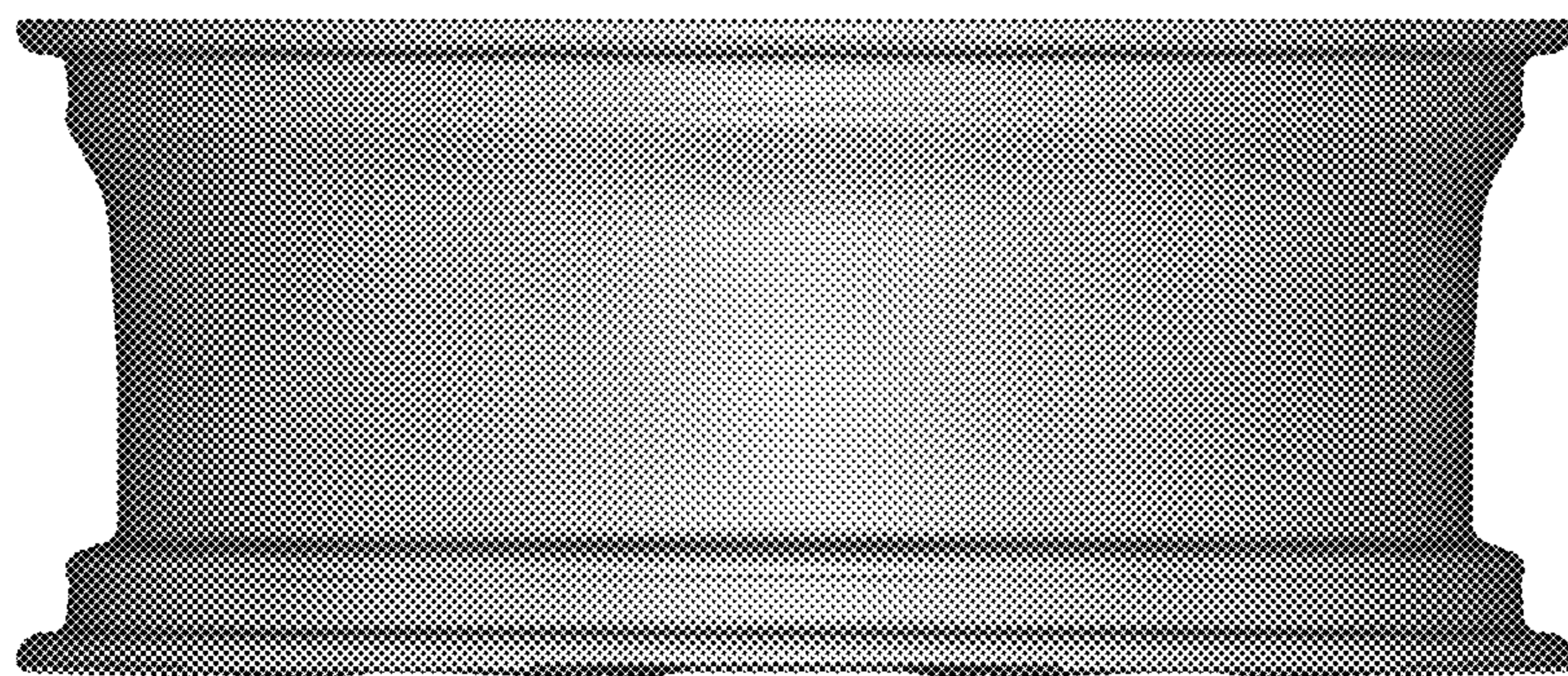

FIG. 6



FIG. 7