



US00D966928S

(12) **United States Design Patent**  
**Webber**

(10) **Patent No.:** **US D966,928 S**

(45) **Date of Patent:** **\*\* Oct. 18, 2022**

(54) **EAR DEVICE ATTACHMENT BRACKET**

(71) Applicant: **Meridyth Mischel Webber**, Fort Lee,  
NJ (US)

(72) Inventor: **Meridyth Mischel Webber**, Fort Lee,  
NJ (US)

(73) Assignee: **Khreativity Unlimited, Inc.**, Fort Lee,  
NJ (US)

(\*\*) Term: **15 Years**

(21) Appl. No.: **29/815,350**

(22) Filed: **Nov. 12, 2021**

(51) **LOC (13) Cl.** ..... **11-01**

(52) **U.S. Cl.**  
USPC ..... **D11/88**

(58) **Field of Classification Search**  
USPC ..... D11/1-25, 86  
CPC ..... A44C 7/00; A44C 7/004; A44C 7/005;  
A44C 7/006; A44C 7/007; A44C 7/008  
See application file for complete search history.

(56) **References Cited**

**U.S. PATENT DOCUMENTS**

2,477,780 A \* 8/1949 Armstrong ..... A44C 7/008  
135/31  
D242,817 S \* 12/1976 Saccoccio ..... D11/88  
D249,252 S \* 9/1978 Gatof ..... D11/88  
D249,337 S \* 9/1978 DiOrio ..... D11/86

D378,360 S \* 3/1997 Montaquila ..... D11/88  
D388,357 S \* 12/1997 Montaquila ..... D11/88  
D389,085 S \* 1/1998 Montaquila ..... D11/88  
D389,424 S \* 1/1998 Montaquila ..... D11/88  
D420,934 S \* 2/2000 Montaquila ..... D11/88  
D533,803 S \* 12/2006 Corso ..... D11/42

\* cited by examiner

*Primary Examiner* — Zenia I Bennett

(74) *Attorney, Agent, or Firm* — Lerner, David,  
Littenberg, Krumholz & Mentlik, LLP

(57) **CLAIM**

The ornamental design for an ear device attachment bracket,  
as shown and described.

**DESCRIPTION**

FIG. 1 is a front perspective view of an ear device attach-  
ment bracket according to our design;  
FIG. 2 is a front view thereof;  
FIG. 3 is a rear view thereof;  
FIG. 4 is a right side view thereof;  
FIG. 5 is a left side view thereof;  
FIG. 6 is a bottom view thereof; and,  
FIG. 7 is a top view thereof.

The ear device attachment bracket of this design is config-  
ured to be attached to any earring or any other ear device for  
attachment to the ear of a user.

Color forms no part of the claimed design.

**1 Claim, 4 Drawing Sheets**

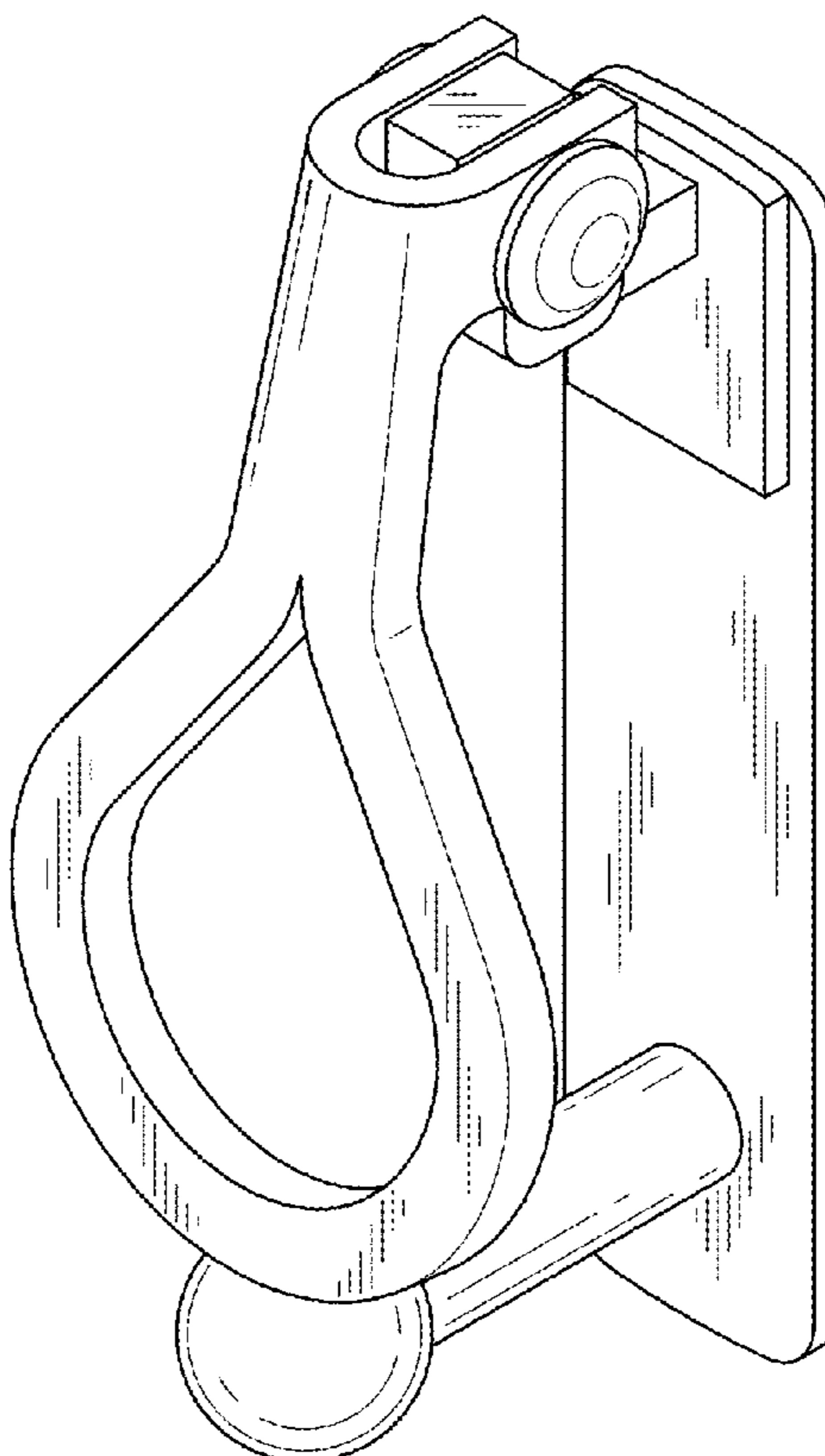

*FIG. 1*

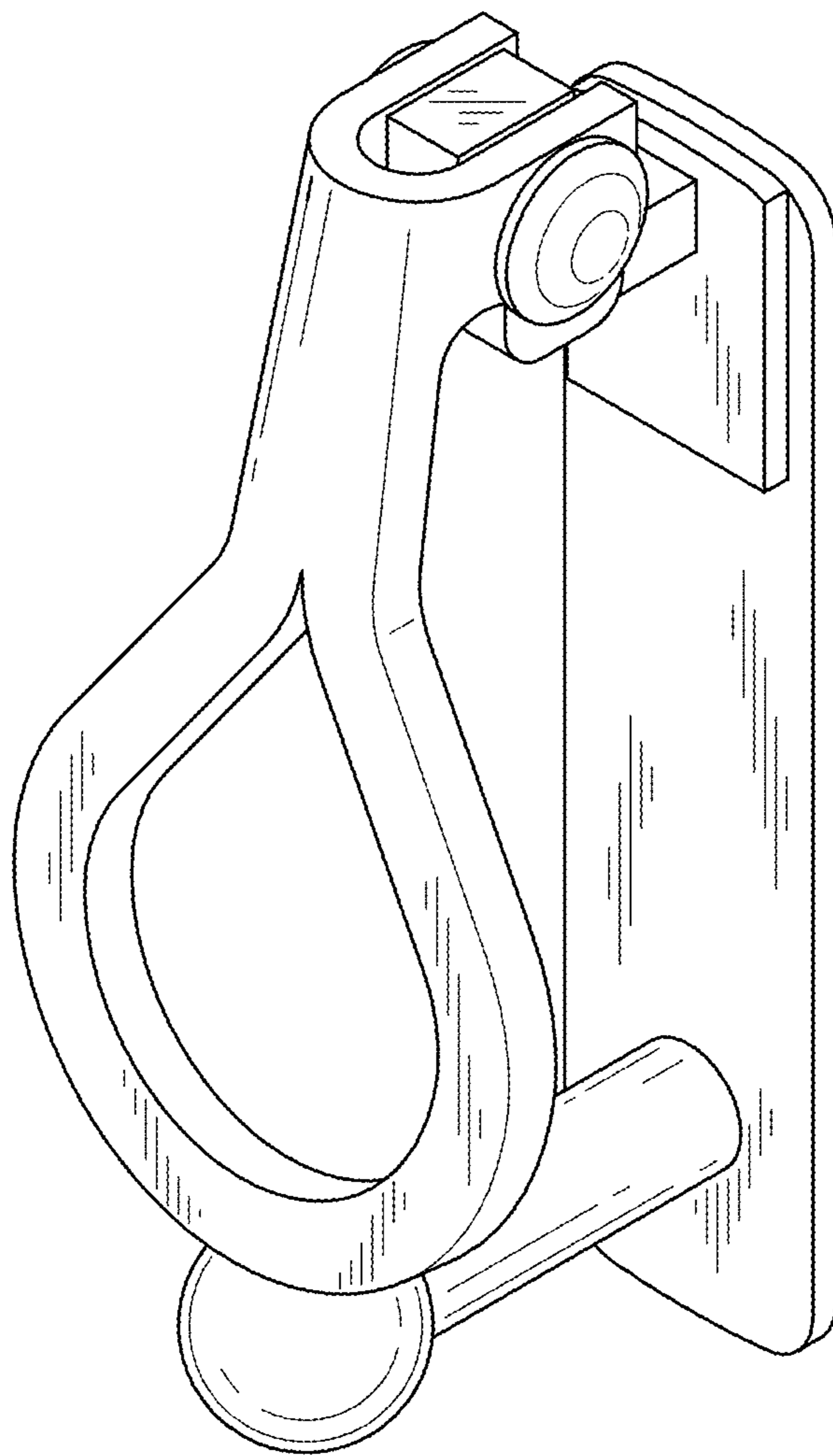

FIG. 2

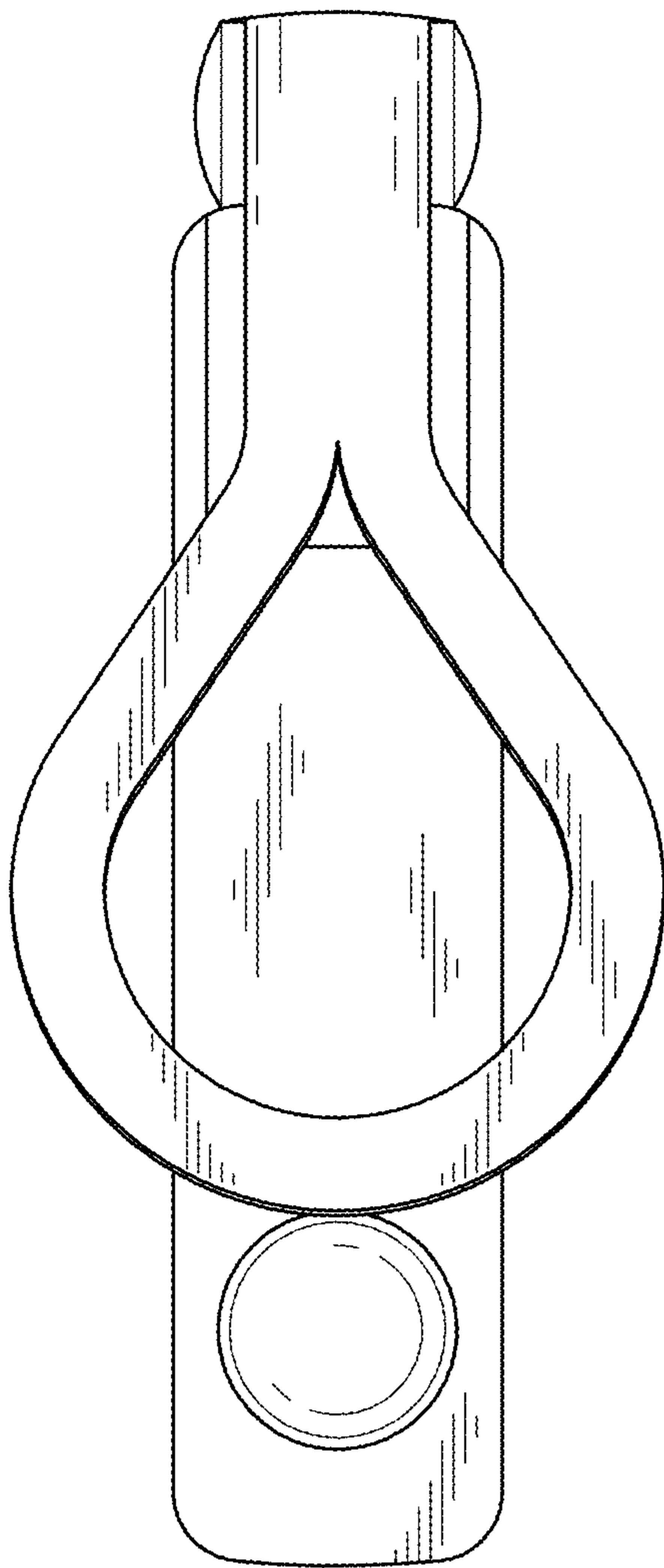

FIG. 3

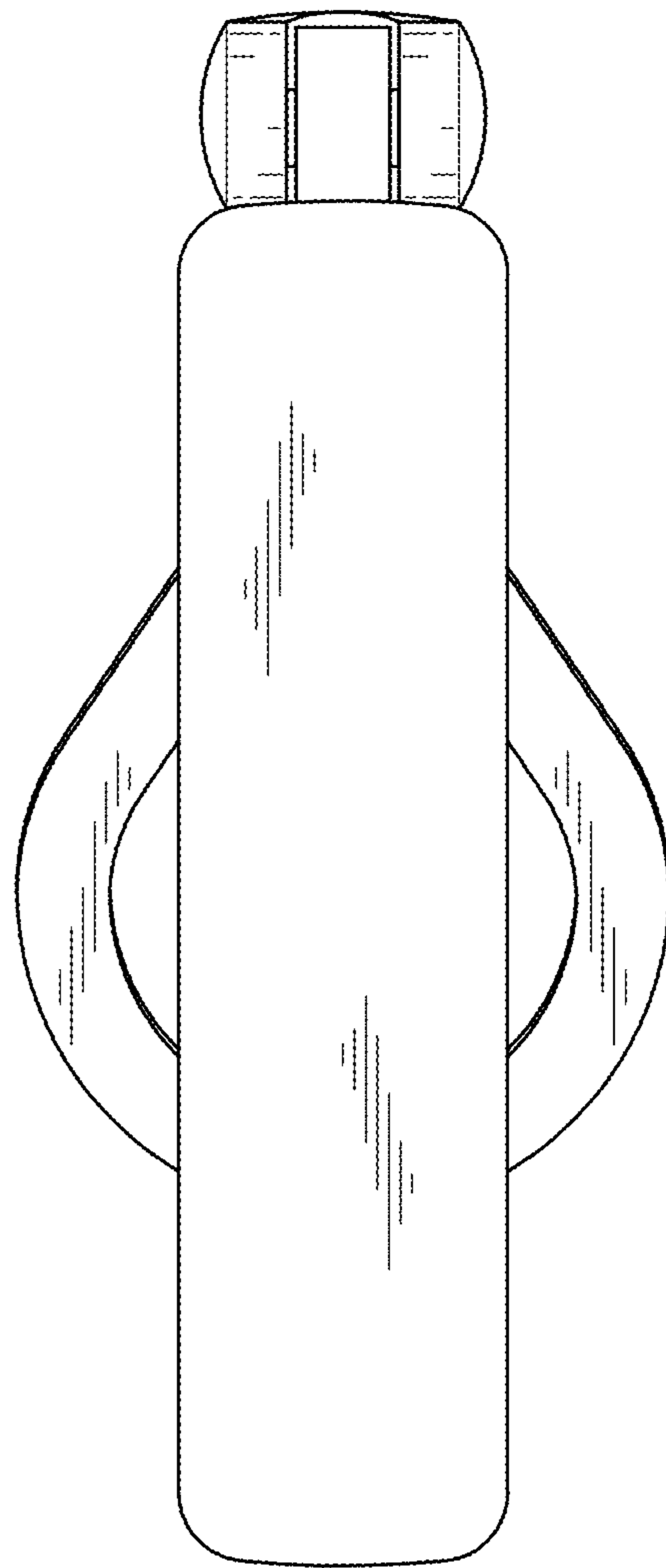

FIG. 4

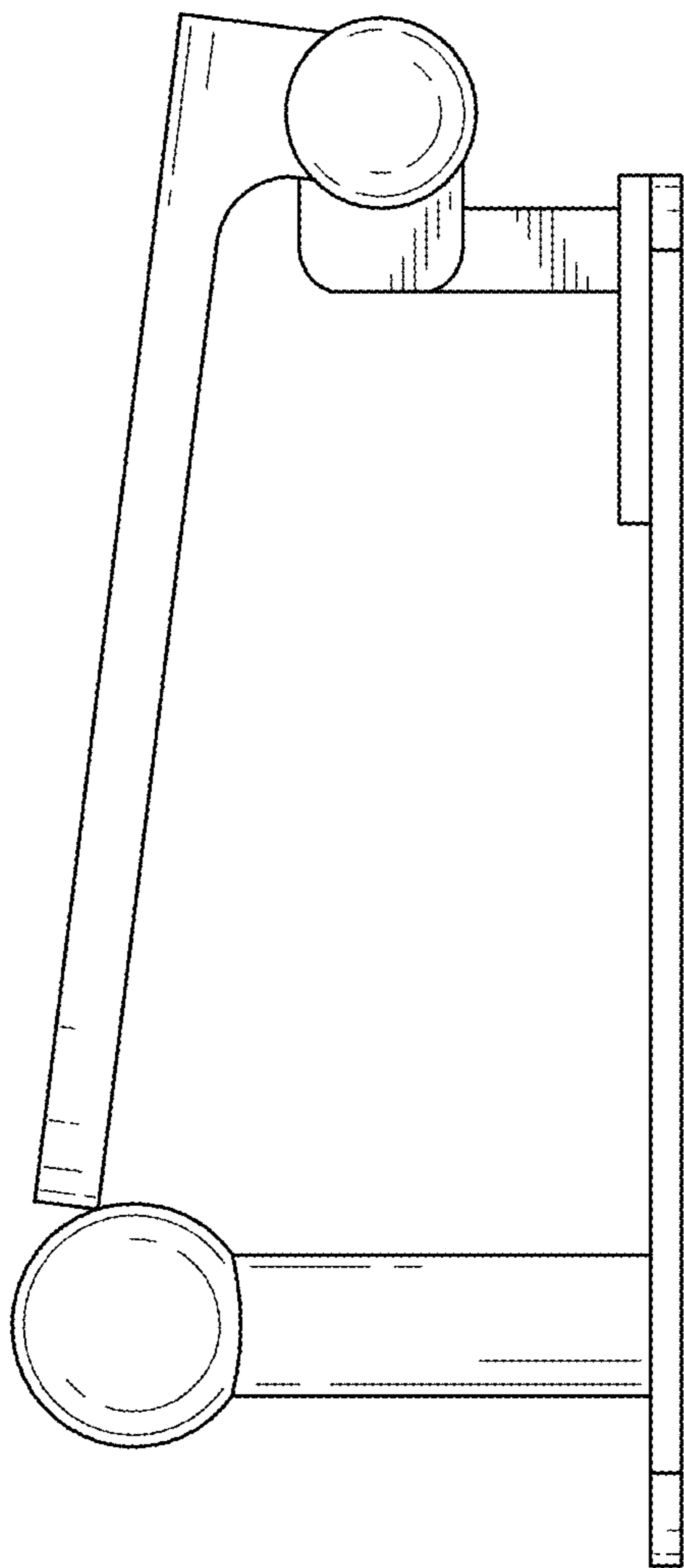

FIG. 5

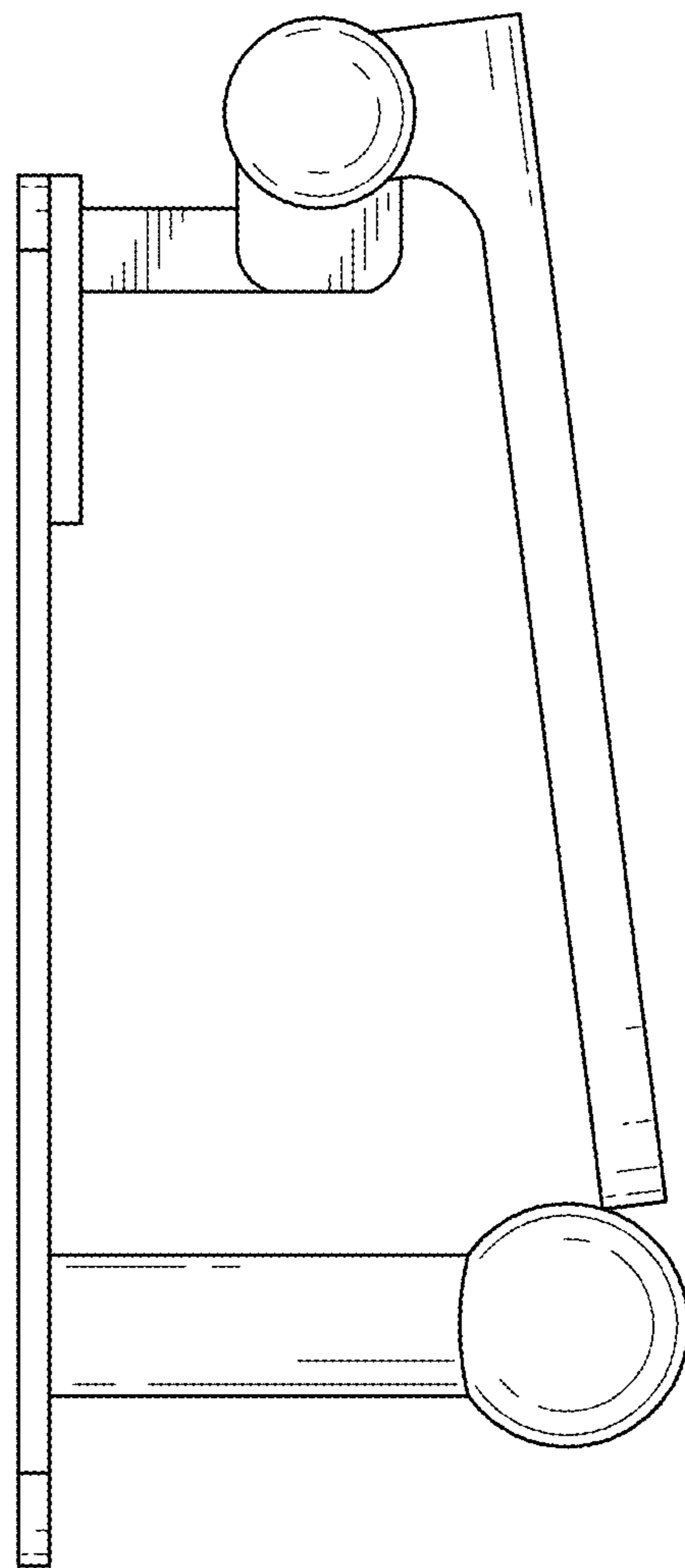

FIG. 6

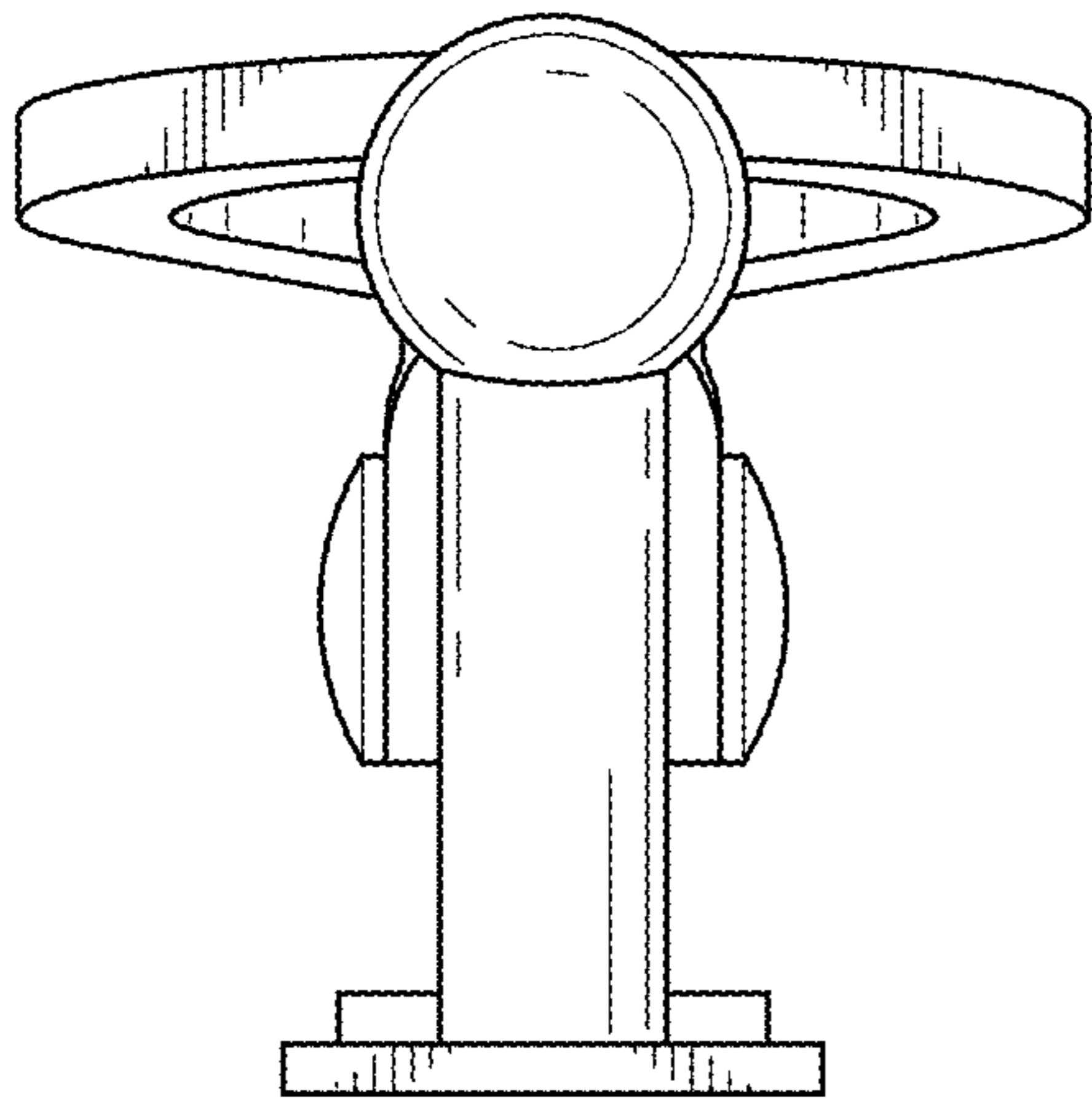

FIG. 7

