

US00D966899S

(12) **United States Design Patent** (10) **Patent No.:** **US D966,899 S**  
**Bright** (45) **Date of Patent:** **\*\* Oct. 18, 2022**

(54) **BOTTLE**  
(71) Applicant: **MSRF, Inc.**, Chicago, IL (US)  
(72) Inventor: **John Bright**, Chicago, IL (US)  
(\*\*) Term: **15 Years**  
(21) Appl. No.: **29/751,713**  
(22) Filed: **Sep. 23, 2020**

4,280,120 A \* 7/1981 Trafford ..... G08B 25/12  
340/303  
D276,708 S \* 12/1984 Simpson ..... D10/104.1  
D279,547 S \* 7/1985 Tobias ..... D9/522  
D294,581 S \* 3/1988 Storlie ..... D9/520  
D304,806 S \* 11/1989 Mednis ..... D9/520  
D349,863 S \* 8/1994 Freedman ..... D10/106.1  
D380,960 S \* 7/1997 Blotsky ..... D9/543  
D428,351 S \* 7/2000 Hohlfelder ..... D10/106.1  
D454,308 S \* 3/2002 Scheida ..... D9/523  
D474,408 S \* 5/2003 Rennie ..... D9/521  
(Continued)

(51) **LOC (13) Cl.** ..... **09-01**  
(52) **U.S. Cl.**  
USPC ..... **D9/572; D9/679**  
(58) **Field of Classification Search**  
USPC ..... D9/499, 516, 520, 522, 523, 544, 550,  
D9/553, 554, 572, 600, 636, 640, 652,  
D9/679; D23/214; D29/125, 126, 129;  
D10/106.2, 106.4, 106.5, 104.1, 106.1  
CPC .. B65D 23/00; B65D 1/02; B65D 2501/0009;  
B65D 2501/0081  
See application file for complete search history.

OTHER PUBLICATIONS

Amazon. Fire Alarm Flask. First available Jan. 22, 2015. Visited  
Mar. 15, 2022. <https://www.amazon.com/Fire-Alarm-Emergency-Funny-Novelty/dp/B00SLM9XHA?th=1> (Year: 2015).\*  
(Continued)

*Primary Examiner* — Darcey E Gottschalk  
*Assistant Examiner* — Vanessa M. Pursley  
(74) *Attorney, Agent, or Firm* — Knechtel, Demeur & Samlan

(56) **References Cited**  
U.S. PATENT DOCUMENTS

D45,094 S \* 12/1913 Rowland ..... D9/600  
D45,997 S \* 6/1914 Liebenthal ..... D9/542  
1,425,797 A \* 8/1922 Schneiderman ..... G08B 25/12  
340/304  
D93,548 S \* 10/1934 Durbin ..... D10/106.1  
2,043,122 A \* 6/1936 Rohland ..... G08B 25/12  
185/37  
2,129,345 A \* 9/1938 Cover ..... H04M 11/04  
379/47  
2,356,989 A \* 8/1944 Getz ..... A62C 35/605  
70/422  
D190,306 S \* 5/1961 Holmes ..... D10/106.1  
3,325,800 A \* 6/1967 Messick ..... G08B 3/02  
340/297  
D208,042 S \* 7/1967 Jacoby ..... D10/106.1  
D222,609 S \* 11/1971 Plummer ..... D9/640

(57) **CLAIM**

I claim the ornamental design for a bottle, as shown and described.

**DESCRIPTION**

FIG. 1 is a top, front, perspective view of a bottle showing my new design;  
FIG. 2 is a front view thereof;  
FIG. 3 is a left side view thereof;  
FIG. 4 is a right side view thereof;  
FIG. 5 is a rear view thereof;  
FIG. 6 is a top plan view thereof; and,  
FIG. 7 is a bottom plan view thereof.  
In the drawings, the broken lines show portions of the bottle that form no part of the claim.

**1 Claim, 6 Drawing Sheets**

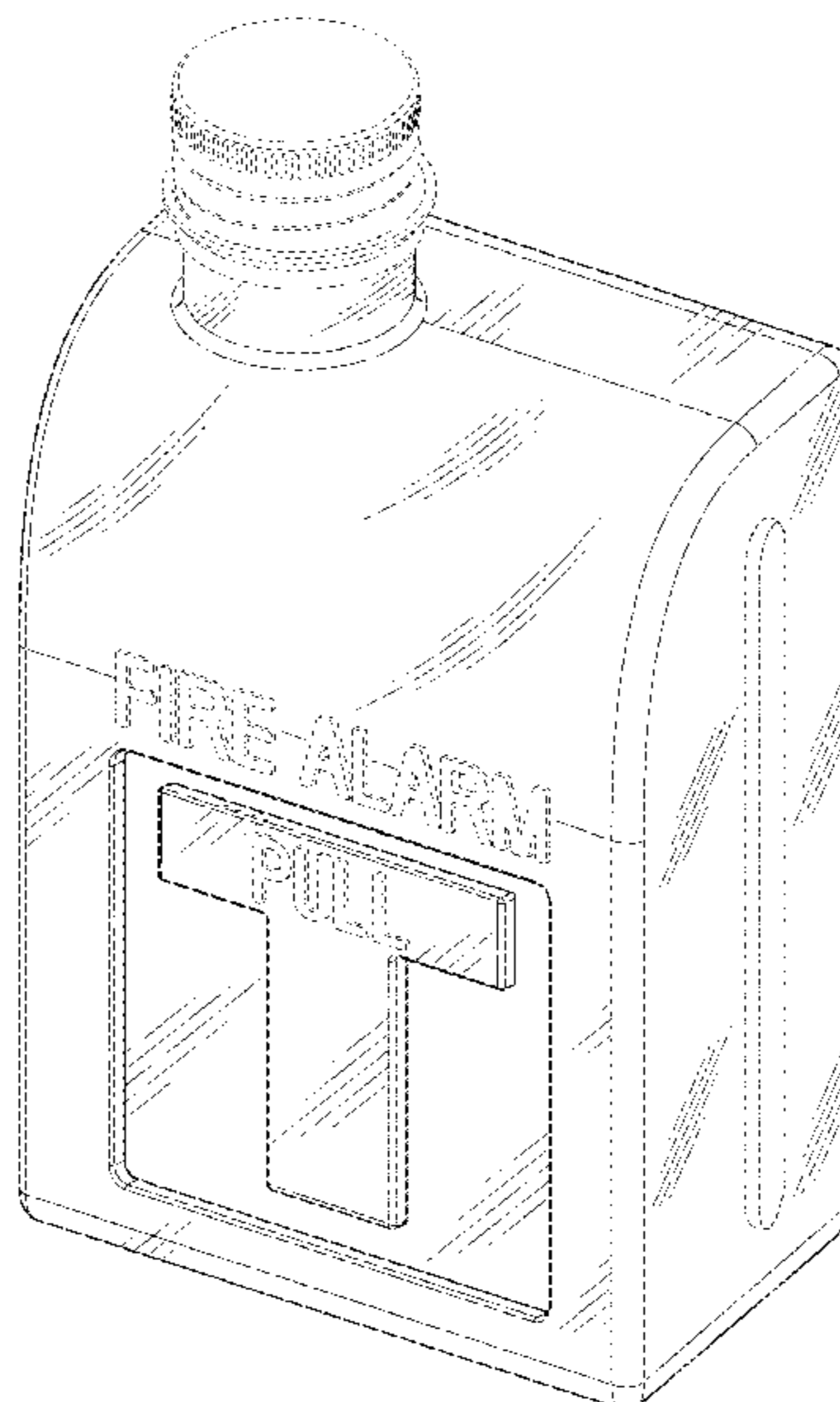

(56)

References Cited

U.S. PATENT DOCUMENTS

D488,061 S \* 4/2004 Jacobson ..... D9/600  
D508,407 S \* 8/2005 Busch ..... D9/563  
D540,180 S \* 4/2007 Edwards ..... D9/600  
D669,355 S \* 10/2012 Gonzalez Rodriguez .... D9/551  
D721,976 S \* 2/2015 Cornelius ..... D9/527  
D760,444 S \* 6/2016 Kozlowski ..... D29/125  
D769,721 S \* 10/2016 Zahr ..... D9/523  
D773,303 S \* 12/2016 Lundberg ..... D7/619.1  
D775,527 S \* 1/2017 Blachford ..... D9/523  
D784,149 S \* 4/2017 Funk ..... D9/520  
D806,554 S \* 1/2018 Santoro ..... D9/575  
D845,778 S \* 4/2019 Lauret ..... G08B 25/12  
D867,888 S \* 11/2019 Essenburg ..... G08B 25/12  
D902,062 S \* 11/2020 Dickman ..... D10/106.1

D935,889 S \* 11/2021 Bodum ..... A62C 35/605  
D9/563  
D953,874 S \* 6/2022 Bright ..... D9/679  
2007/0063821 A1\* 3/2007 Finkle ..... G08B 25/12  
340/287

OTHER PUBLICATIONS

Ebay. Vintage “Avon” Fire Alarm Bottle Preshave Lotion With Original Box, 1970’s. Last updated Sep. 5, 2021. Visited Mar. 15, 2022. <https://www.ebay.com/itm/Vintage-Avon-Fire-Alarm-Bottle-Preshave-Lotion-With-Original-Box-1970s-/133431421542> (Year: 2021).\*

Grainger. Fire Pull Station. Publication date unavailable. Visited Mar. 15, 2022. <https://www.grainger.com/product/54TT19> (Year: 0).\*

\* cited by examiner

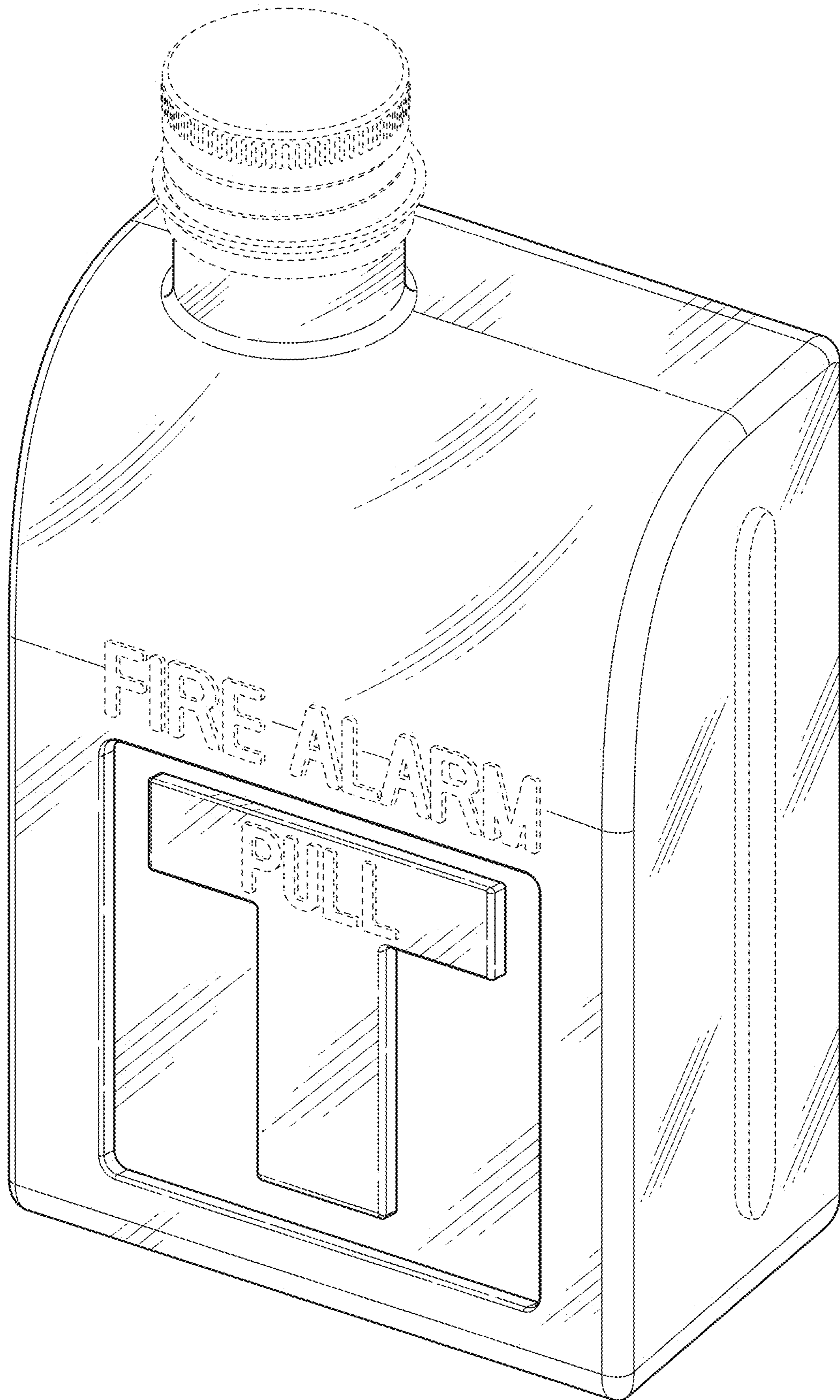

FIG. 1

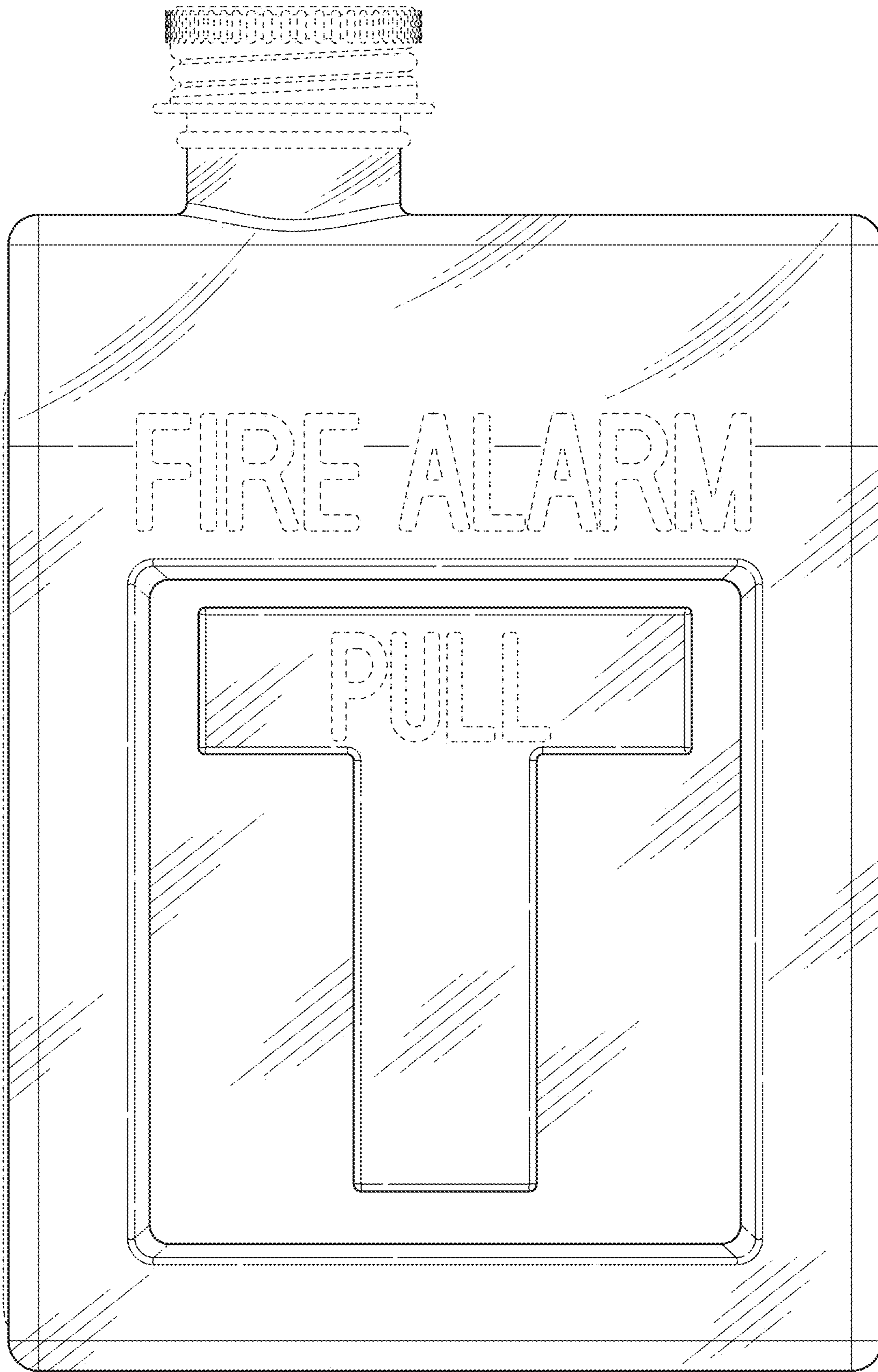

FIG. 2

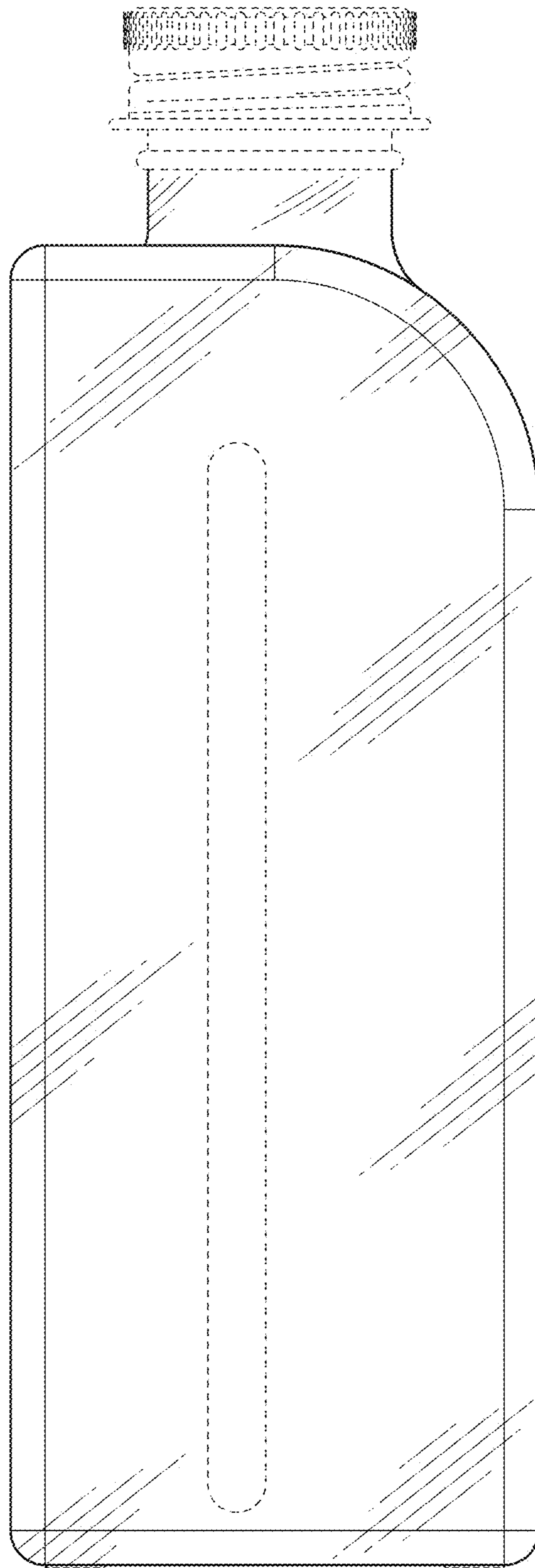

FIG. 3

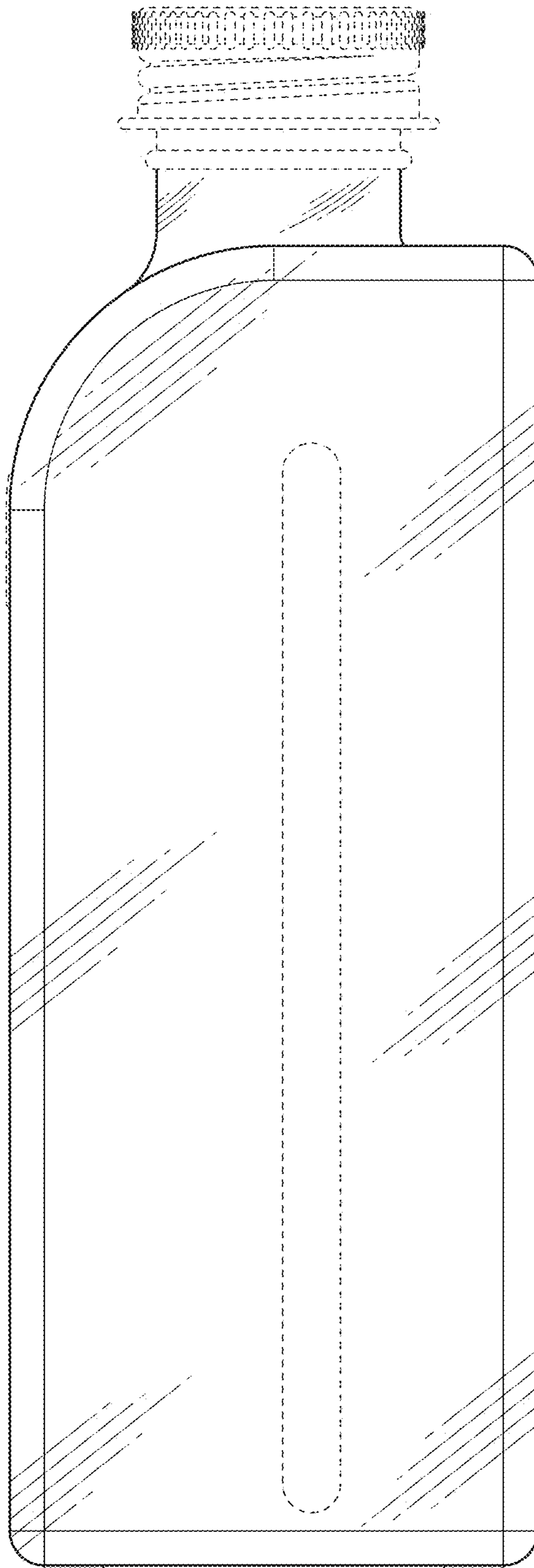

FIG. 4

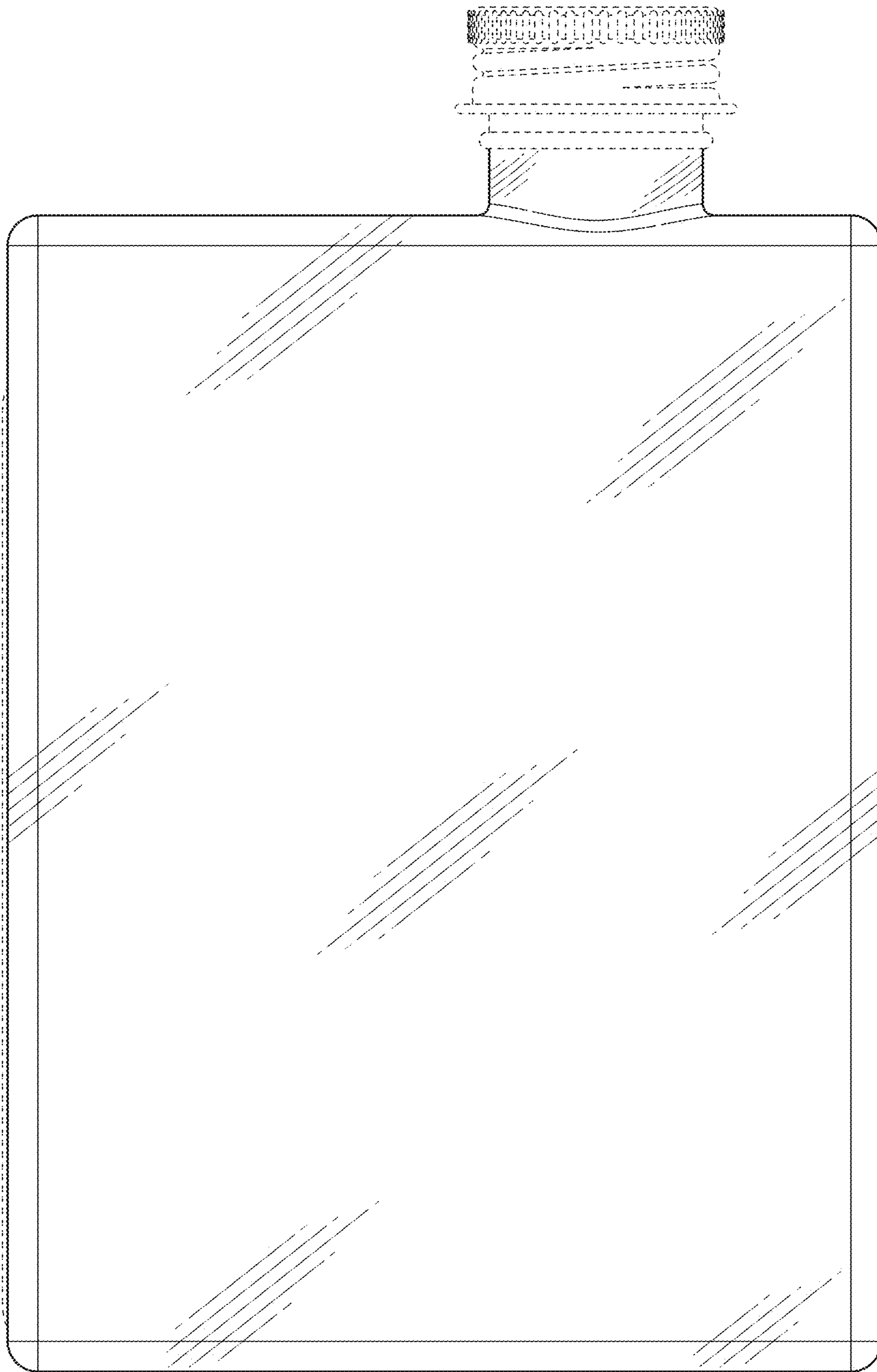

FIG. 5

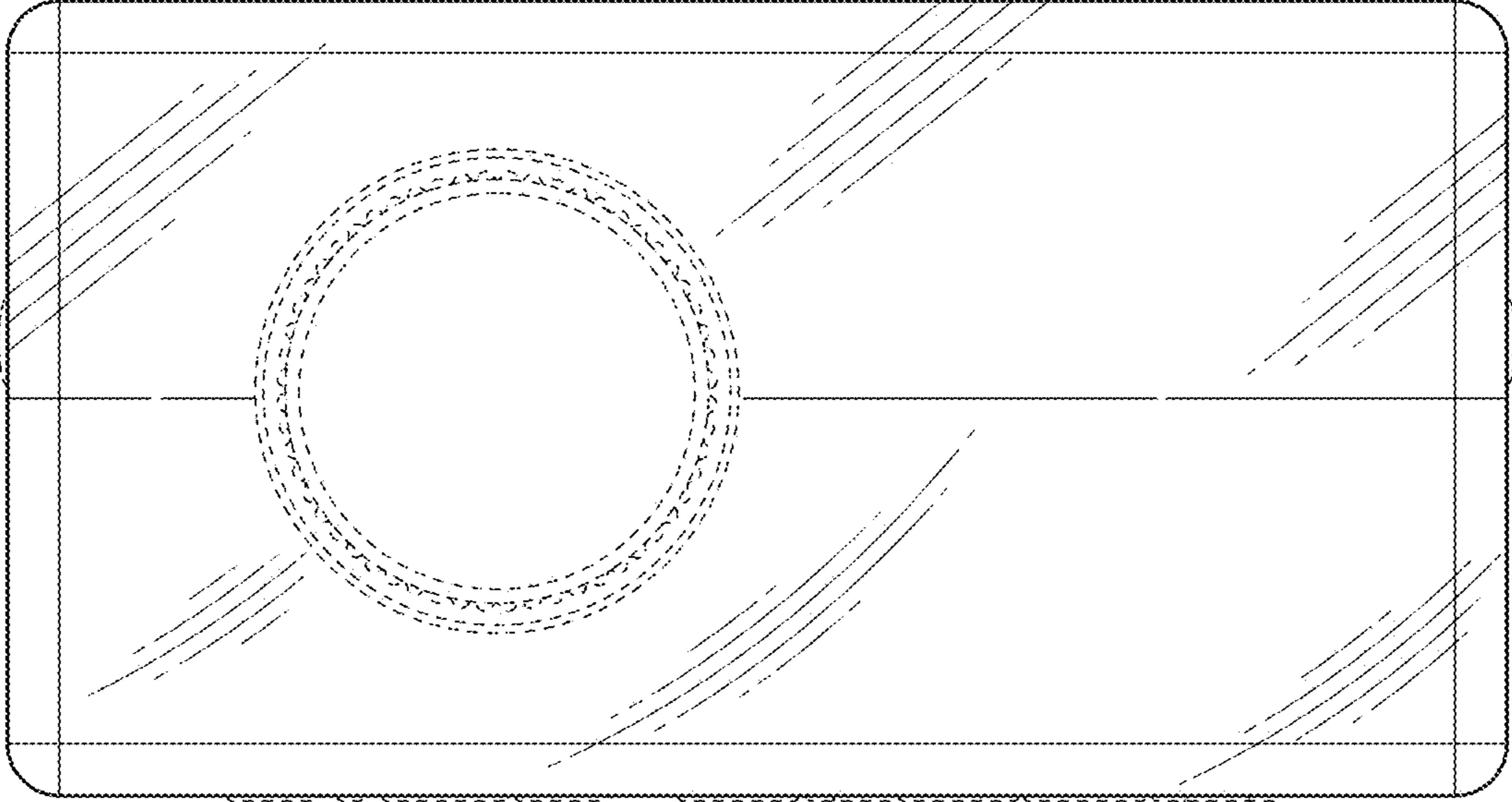

FIG. 6

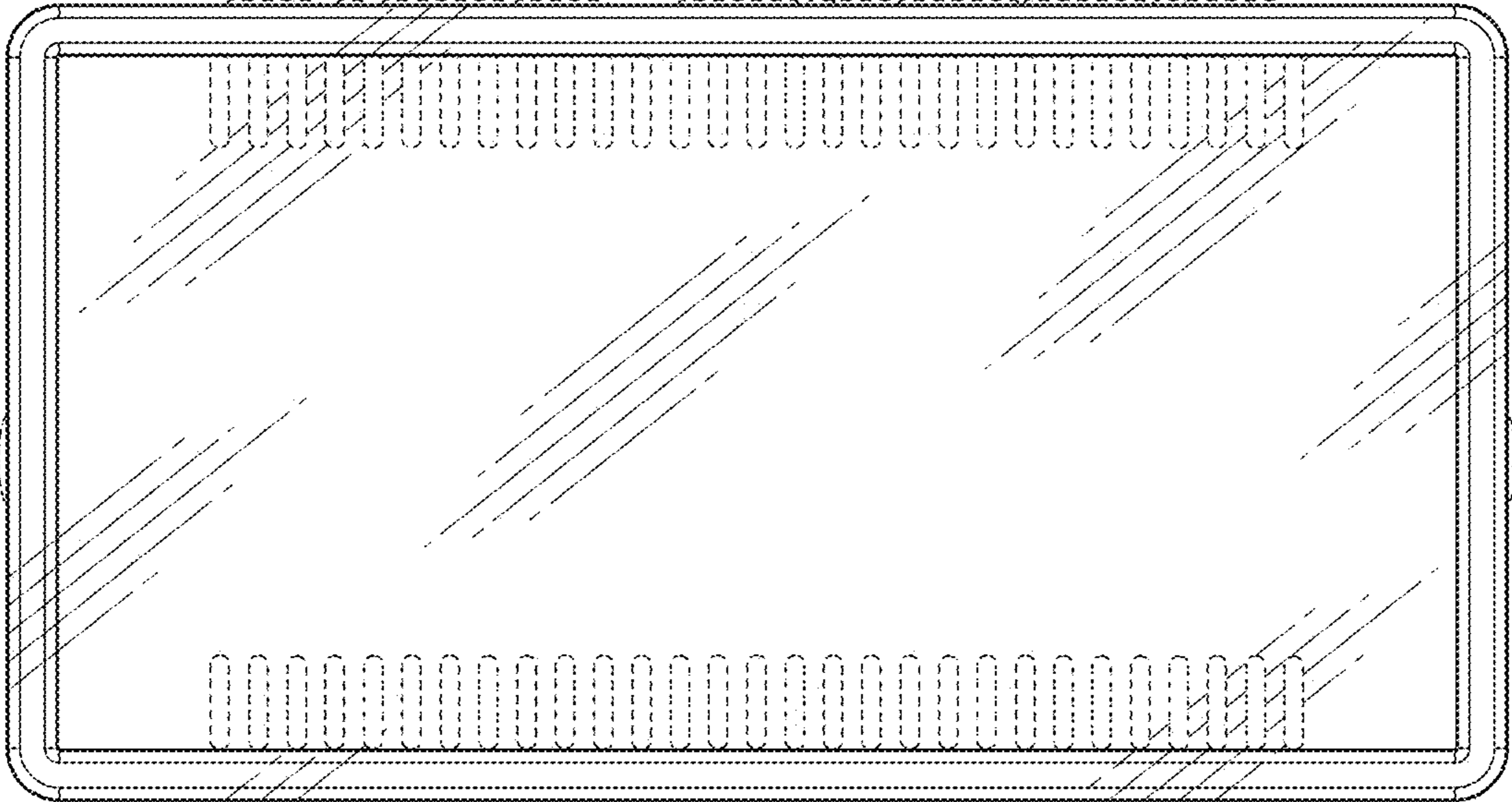

FIG. 7