



US00D966894S

(12) **United States Design Patent**
Sterling et al.

(10) **Patent No.:** **US D966,894 S**

(45) **Date of Patent:** **** Oct. 18, 2022**

(54) **CONTAINER**

(71) Applicant: **Henkel AG & Co. KGaA**, Duesseldorf (DE)

(72) Inventors: **Daniel Peter Sterling**, Fairfield, CT (US); **Ryan Joseph Boudreaux**, Yorktown Heights, NY (US); **Trond Erik Tollefsen**, Stamford, CT (US)

(73) Assignee: **Henkel AG & Co. KGaA**, Duesseldorf (DE)

(**) Term: **15 Years**

(21) Appl. No.: **29/666,961**

(22) Filed: **Oct. 17, 2018**

(51) **LOC (13) Cl.** **09-01**

(52) **U.S. Cl.**

USPC **D9/528; D9/531**

(58) **Field of Classification Search**

USPC **D9/523, 528, 530, 531, 540, 543, 549, D9/550, 563, 572, 575**

(Continued)

(56) **References Cited**

U.S. PATENT DOCUMENTS

D314,140 S * 1/1991 Kornick D7/319

D314,141 S * 1/1991 Kornick D9/443

(Continued)

Primary Examiner — Dana Meyrow

(74) *Attorney, Agent, or Firm* — Bojuan Deng

(57) **CLAIM**

The ornamental design for a container, as shown and described.

DESCRIPTION

FIG. 1 is a front perspective view of a first embodiment of a container, showing our new design;

FIG. 2 is a front elevation view thereof;
FIG. 3 is a rear elevation view thereof;
FIG. 4 is a left side elevation view thereof;
FIG. 5 is a right side elevation view thereof;
FIG. 6 is a top plan view thereof;
FIG. 7 is a bottom plan view thereof;
FIG. 8 is a front perspective view of a second embodiment of a container, showing our new design;
FIG. 9 is a front elevation view thereof;
FIG. 10 is a rear elevation view thereof;
FIG. 11 is a left side elevation view thereof;
FIG. 12 is a right side elevation view thereof;
FIG. 13 is a top plan view thereof;
FIG. 14 is a bottom plan view thereof;
FIG. 15 is a front perspective view of a third embodiment of a container, showing our new design;
FIG. 16 is a front elevation view thereof;
FIG. 17 is a rear elevation view thereof;
FIG. 18 is a left side elevation view thereof;
FIG. 19 is a right side elevation view thereof;
FIG. 20 is a top plan view thereof;
FIG. 21 is a bottom plan view thereof;
FIG. 22 is a front perspective view of a fourth embodiment of a container, showing our new design;
FIG. 23 is a front elevation view thereof;
FIG. 24 is a rear elevation view thereof;
FIG. 25 is a left side elevation view thereof;
FIG. 26 is a right side elevation view thereof;
FIG. 27 is a top plan view thereof;
FIG. 28 is a bottom plan view thereof;
FIG. 29 is a front perspective view of a fifth embodiment of a container, showing our new design;
FIG. 30 is a front elevation view thereof;
FIG. 31 is a rear elevation view thereof;
FIG. 32 is a left side elevation view thereof;
FIG. 33 is a right side elevation view thereof;
FIG. 34 is a top plan view thereof; and,
FIG. 35 is a bottom plan view thereof.

The broken lines in the figures illustrate the portions of the container that form no part of the claimed design.

1 Claim, 30 Drawing Sheets

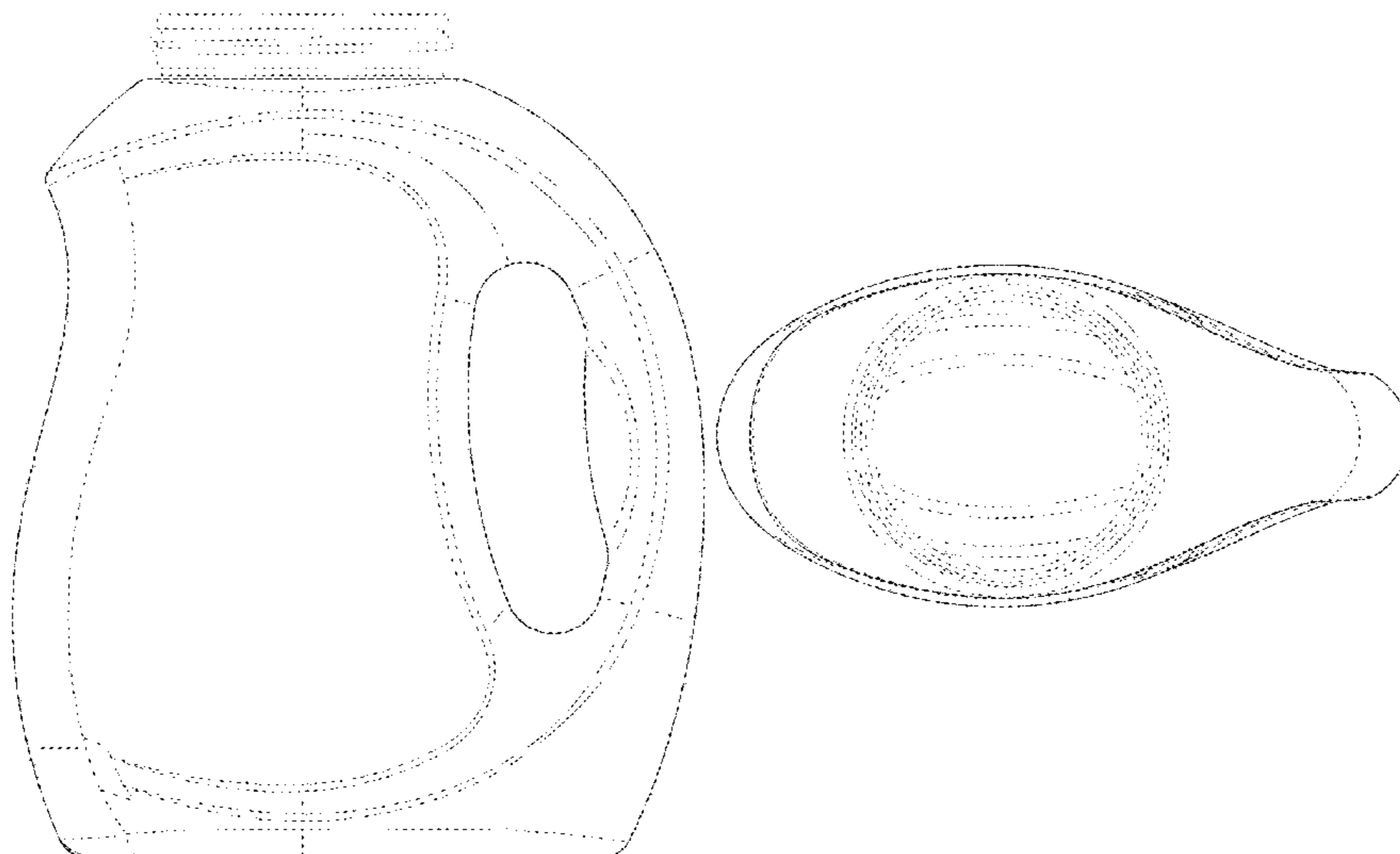

(58) **Field of Classification Search**
 CPC B65D 1/02; B65D 1/0223; B65D 1/023;
 B65D 1/0261; B65D 2501/0009; B65D
 2501/0081; B65D 2501/009
 See application file for complete search history.

(56) **References Cited**

U.S. PATENT DOCUMENTS

D323,456 S *	1/1992	Gonda	D9/528
D358,333 S *	5/1995	Stockwell	D9/528
D390,114 S *	2/1998	Young	D9/520
D421,573 S *	3/2000	Zogg	D9/520
D424,946 S *	5/2000	Alsup	D9/531
D432,016 S *	10/2000	Beaver	D9/528
D454,072 S *	3/2002	Harrity	D9/520
D459,993 S *	7/2002	Clarke	D9/528
D545,202 S *	6/2007	Bates	D9/528
D547,192 S *	7/2007	Meeker	D9/528
D550,559 S *	9/2007	Meeker	D9/528
D562,141 S *	2/2008	Bates	D9/528
D569,732 S *	5/2008	Georg-Muhlhausen	D9/531
D649,882 S *	12/2011	Fleischhacker	D9/531

D658,499 S *	5/2012	Wycoff	D9/528
D679,194 S *	4/2013	Green	D9/658
D726,015 S *	4/2015	Jasso Gomez	D9/531
D726,016 S *	4/2015	Janney	D9/531
D726,017 S *	4/2015	Janney	D9/531
D762,486 S *	8/2016	Meier	D9/719
D784,819 S *	4/2017	Meier	D9/528
D794,462 S *	8/2017	Gerhards	D9/528
D818,366 S *	5/2018	Gerhards	D9/528
D867,146 S *	11/2019	Gerhards	D9/528
D883,791 S *	5/2020	Sterling	D9/563
D883,792 S *	5/2020	Sterling	D9/563
D884,479 S *	5/2020	Hall	D9/531
D891,256 S *	7/2020	Gerhards	D9/575
D900,610 S *	11/2020	Sterling	D9/528
D901,302 S *	11/2020	Sterling	D9/563
D905,556 S *	12/2020	Vlahakis-Hanks	D9/531
D905,557 S *	12/2020	Vlahakis-Hanks	D9/531
D913,794 S *	3/2021	Vlahakis-Hanks	D9/563
D918,046 S *	5/2021	Vlahakis-Hanks	D9/563
D929,234 S *	8/2021	Gerhards	D9/531
D931,108 S *	9/2021	Breen	D9/531
D931,732 S *	9/2021	Gerhards	D9/563
D932,305 S *	10/2021	Vlahakis-Hanks	D9/531

* cited by examiner

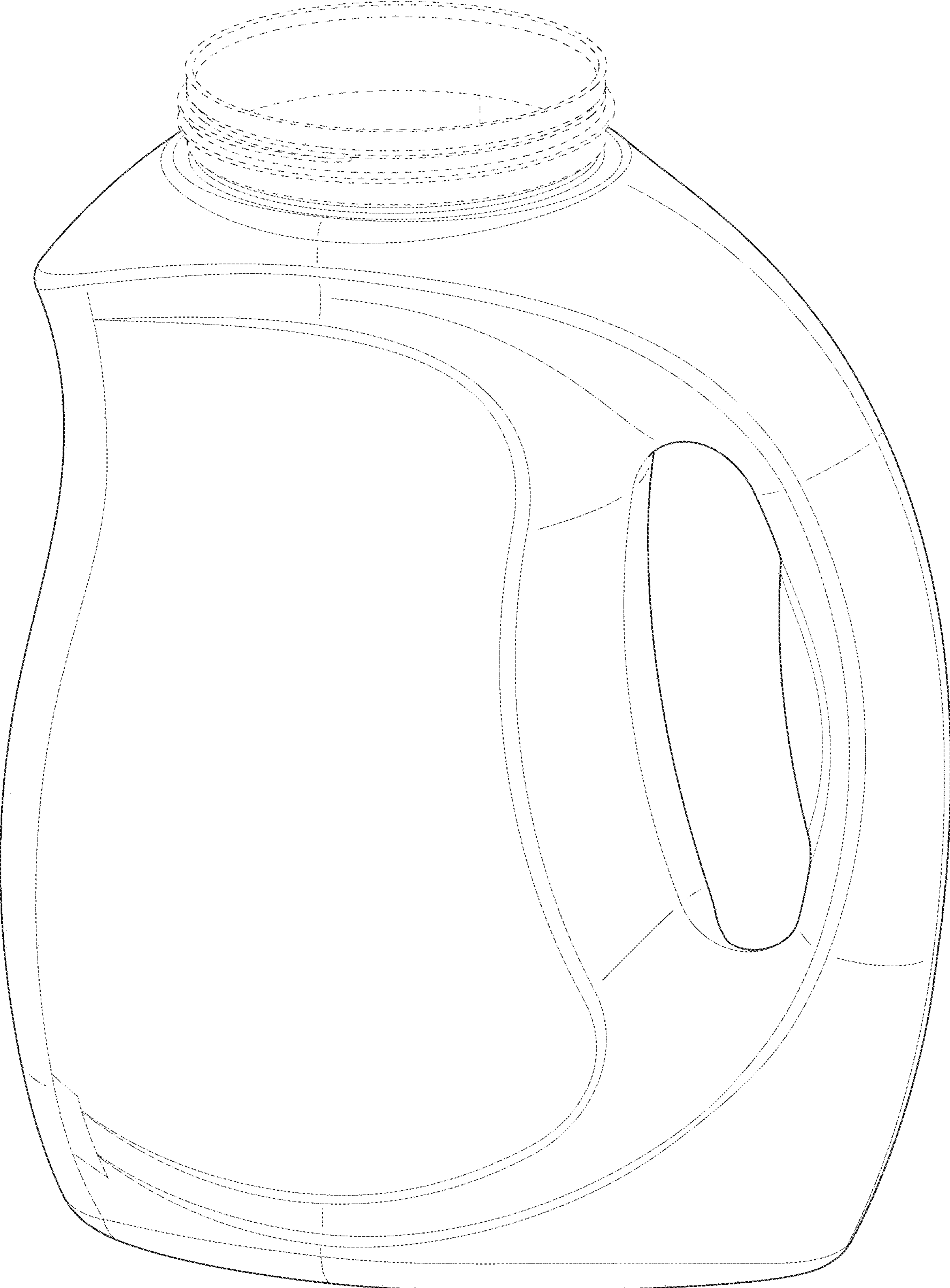

FIG. 1

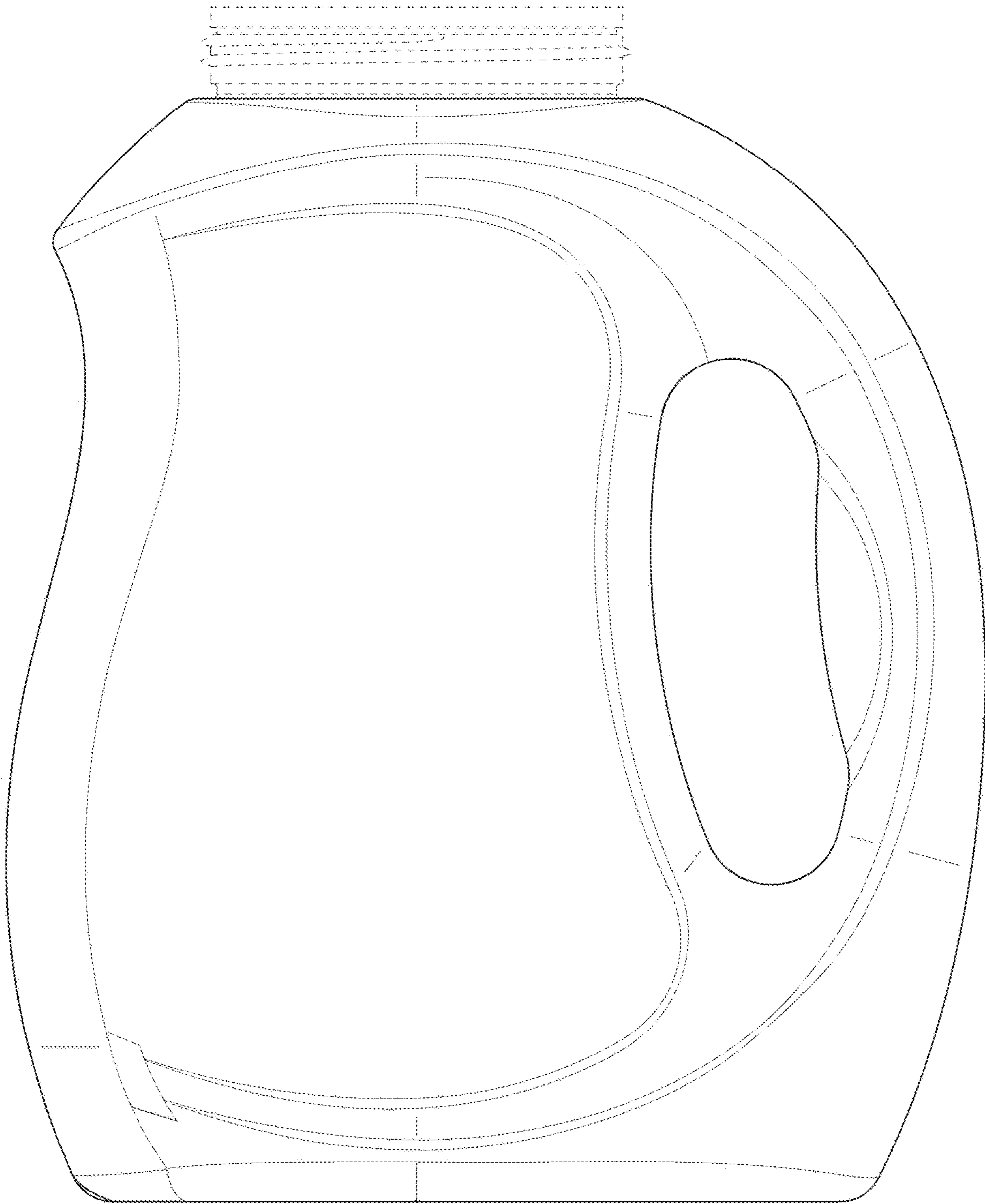

FIG. 2

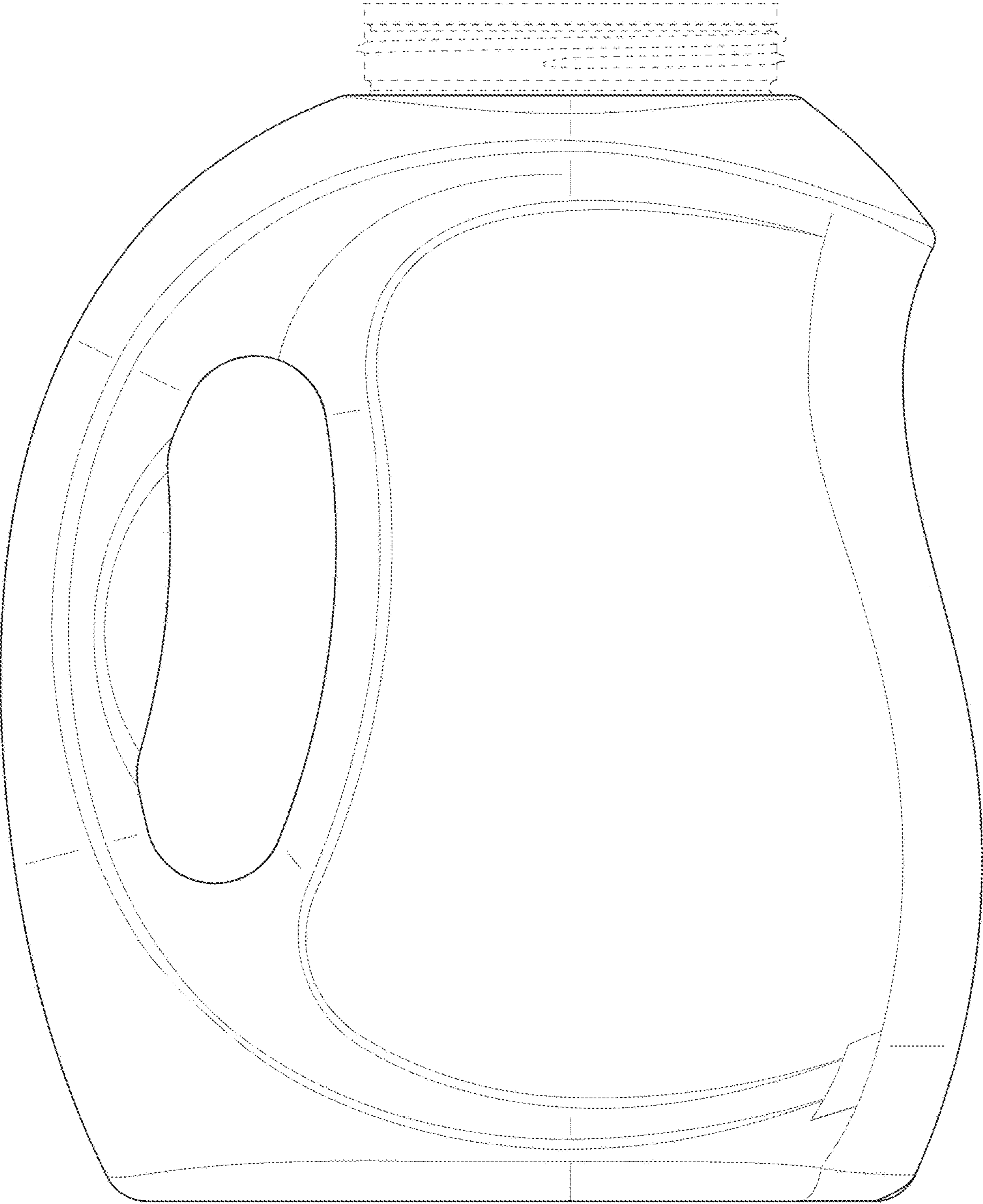

FIG. 3

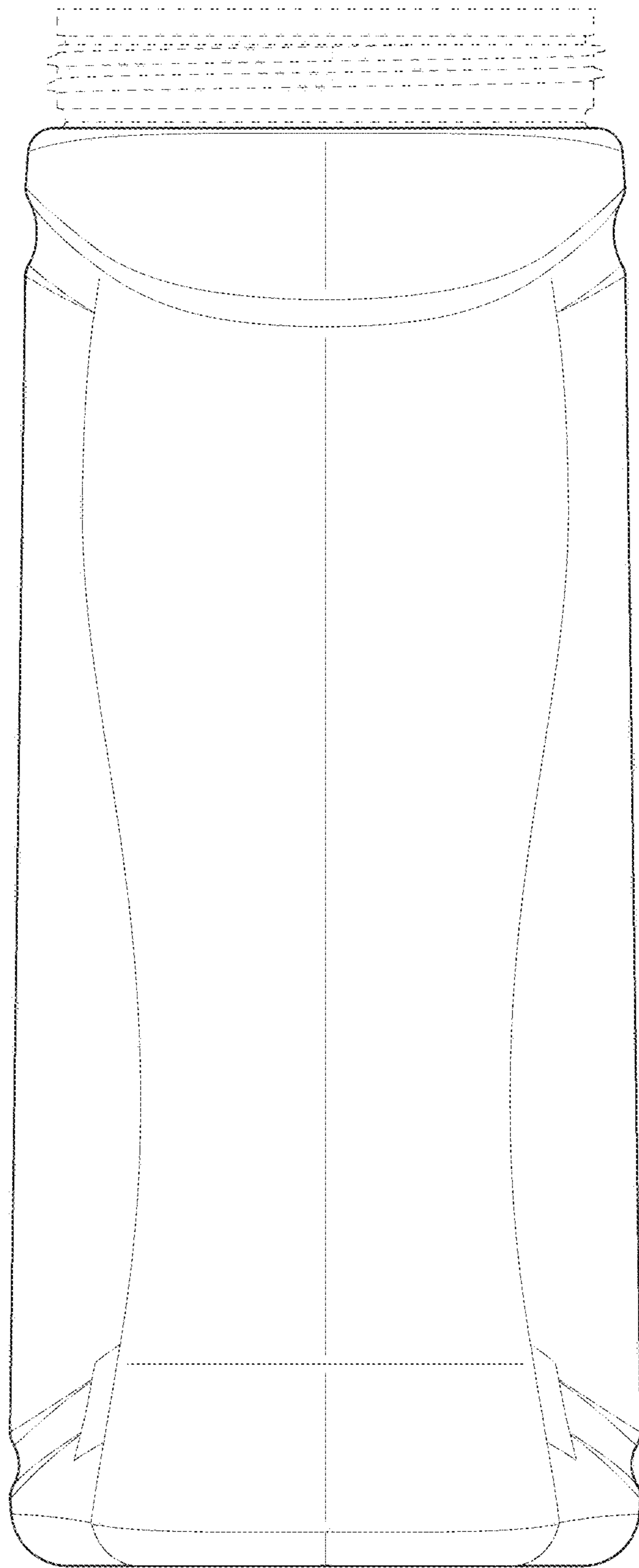

FIG. 4

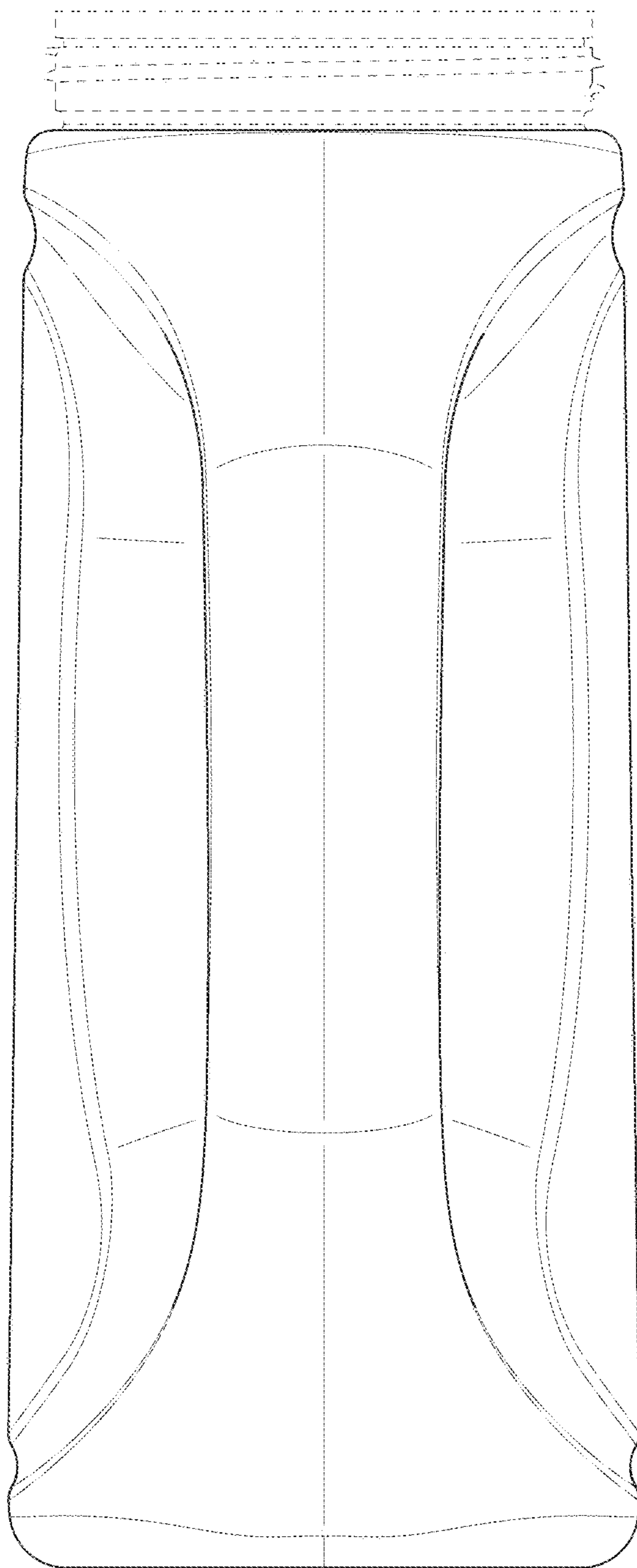

FIG. 5

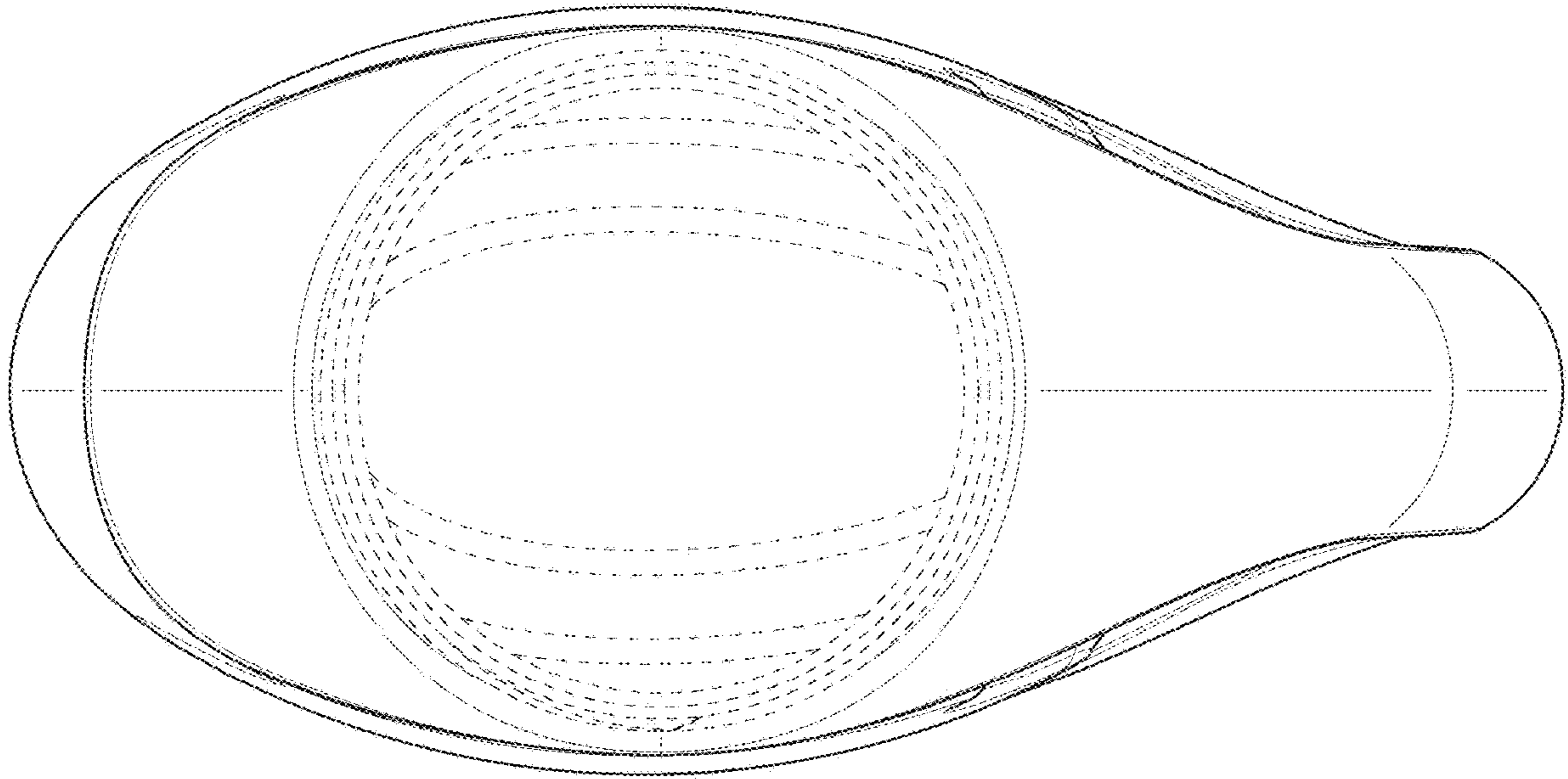

FIG. 6

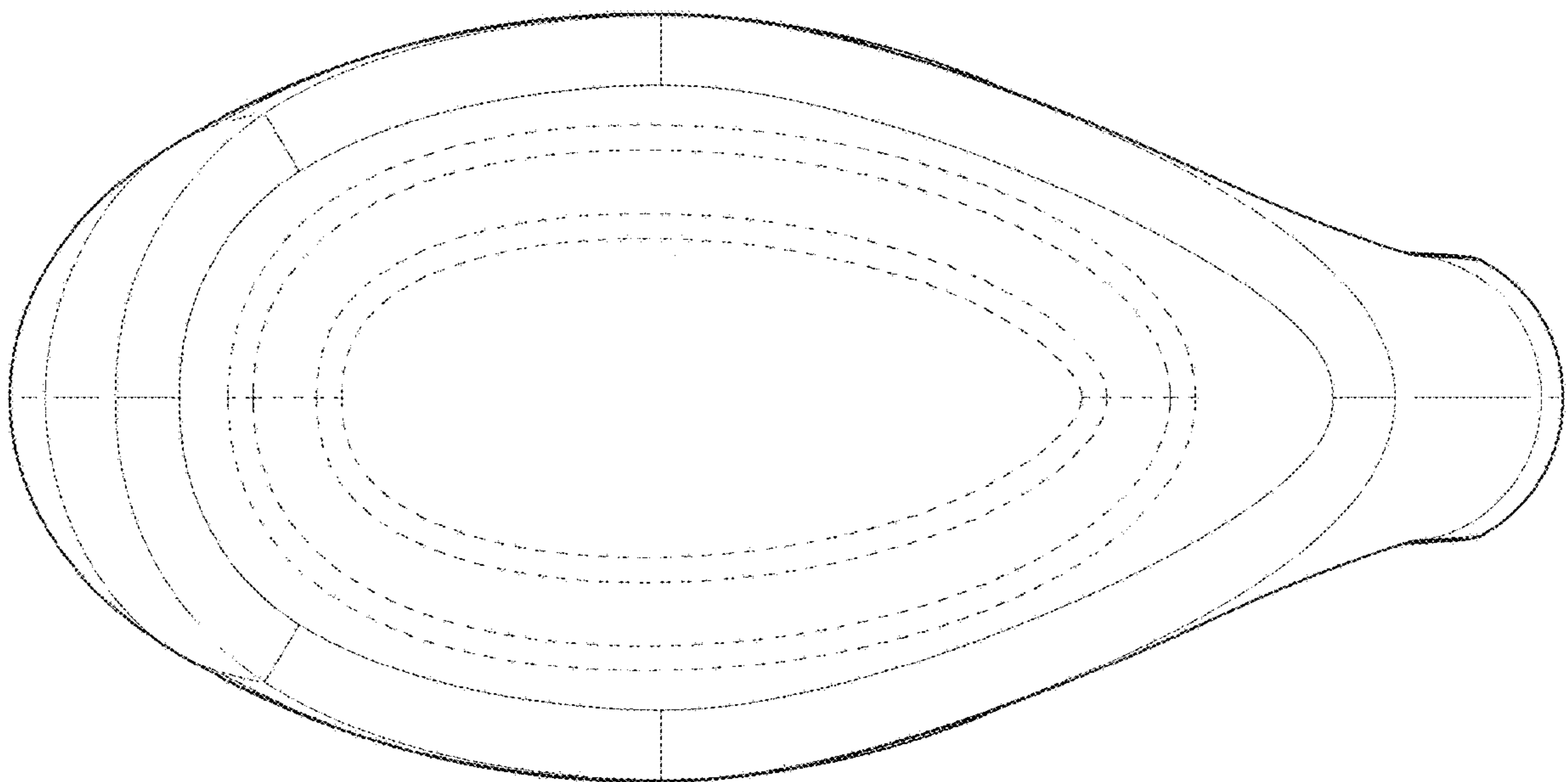

FIG. 7

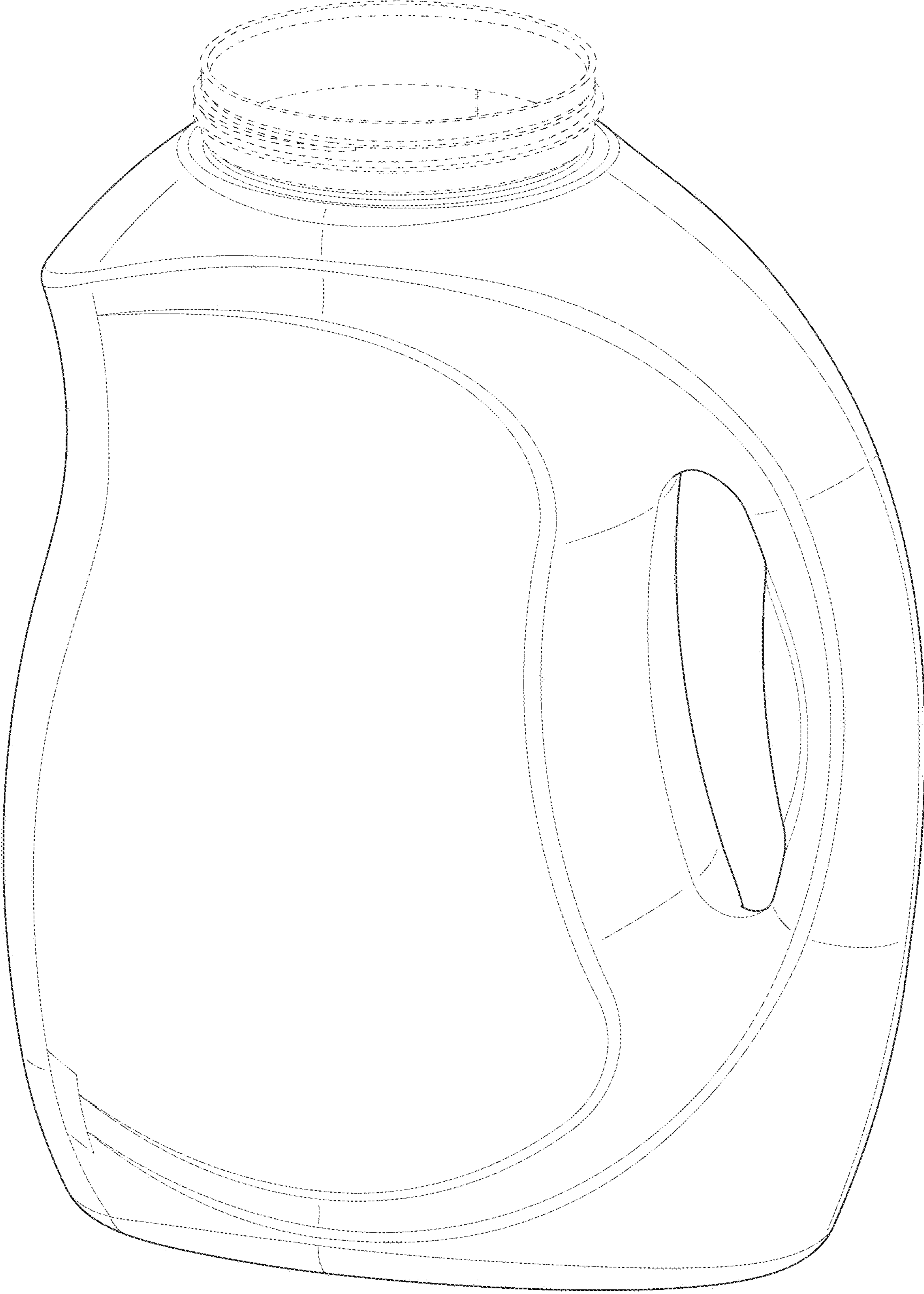

FIG. 8

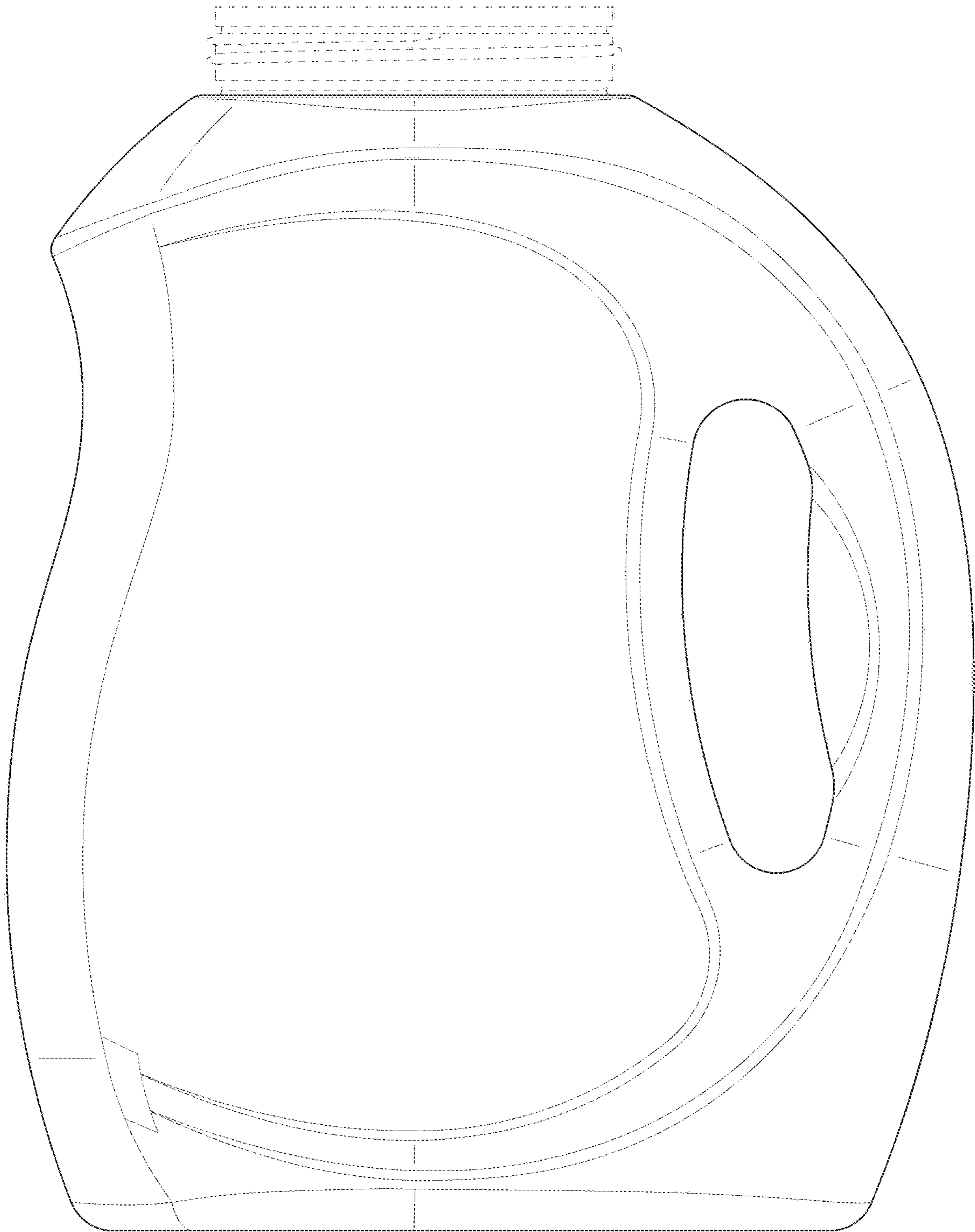

FIG. 9

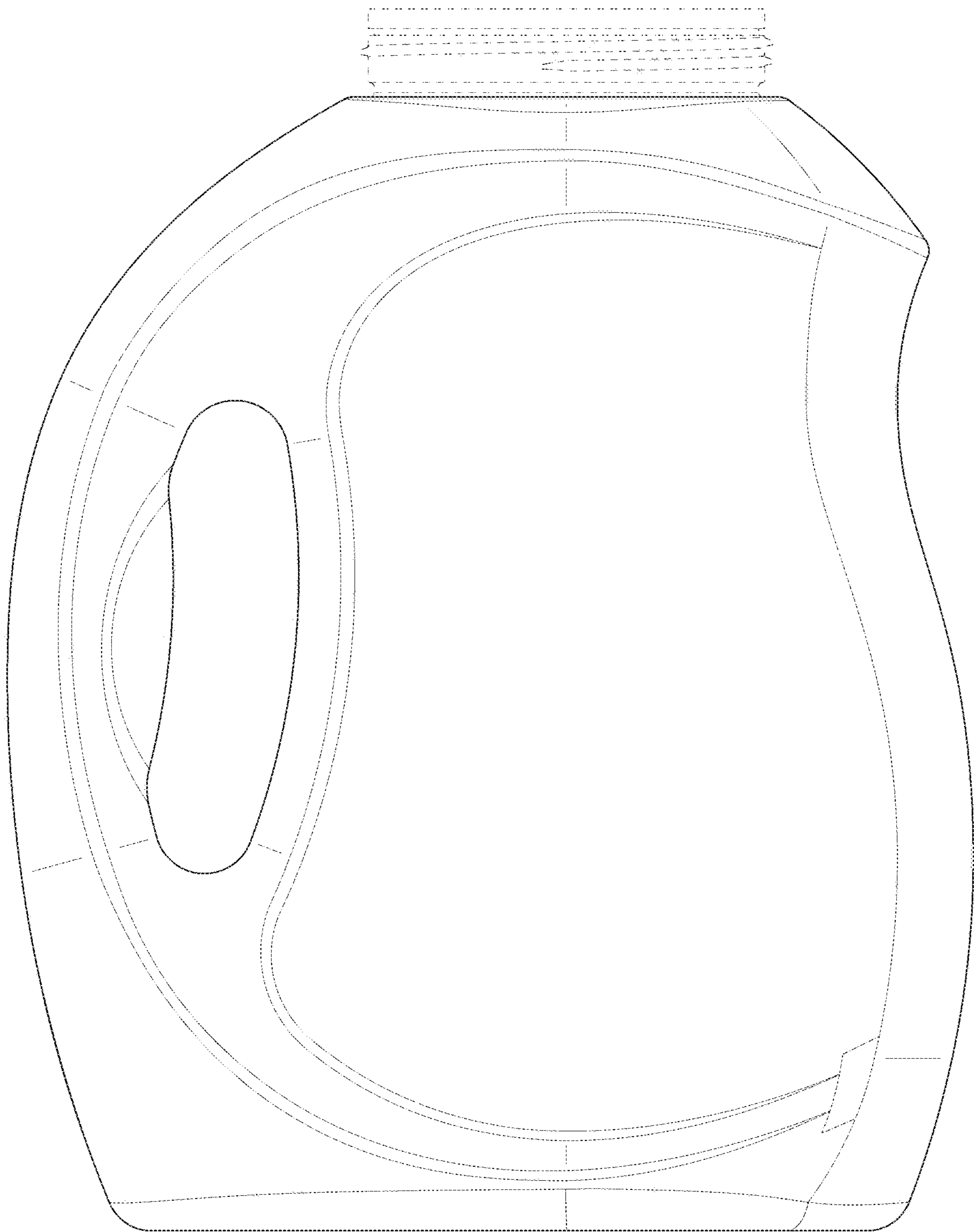

FIG. 10

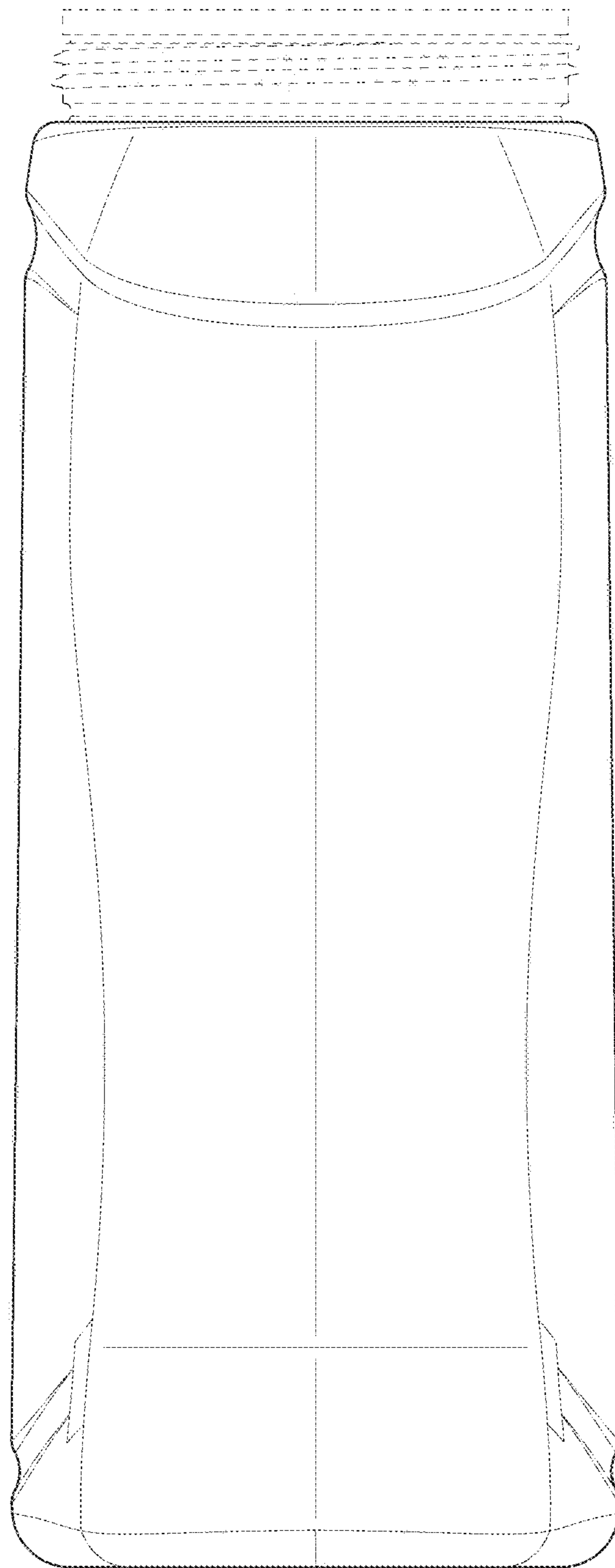

FIG. 11

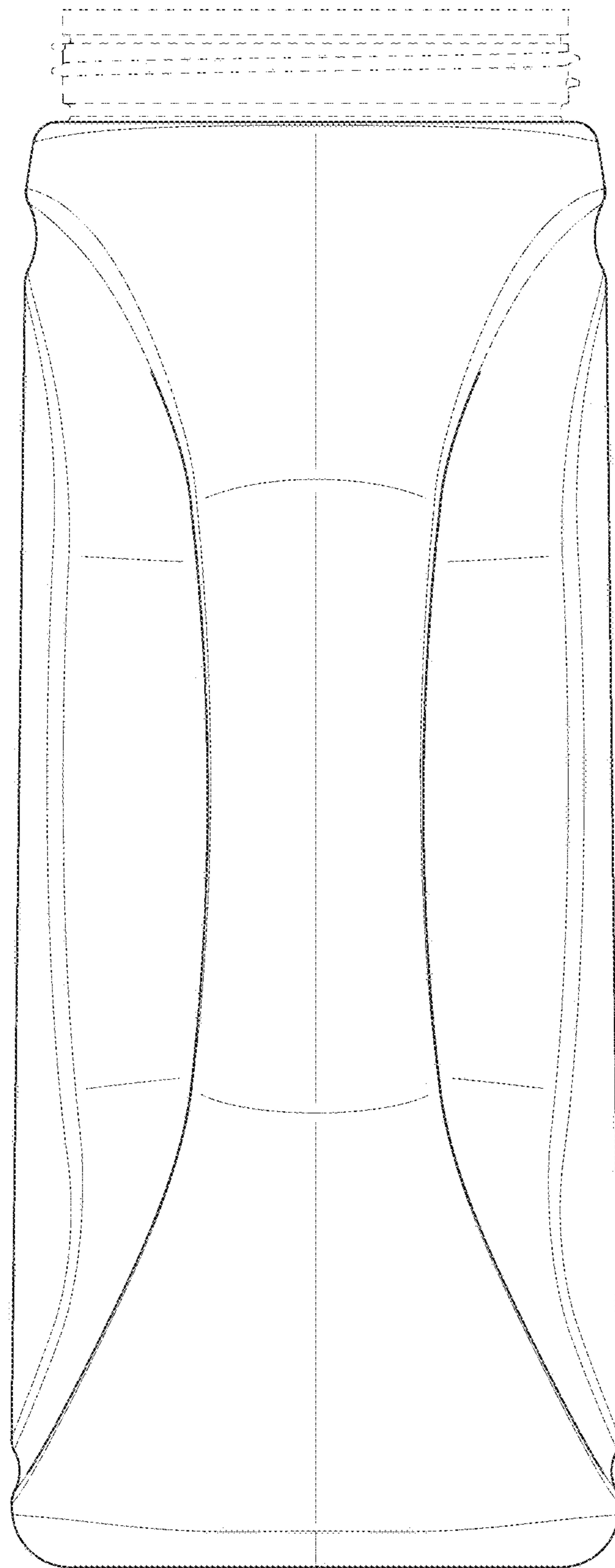

FIG. 12

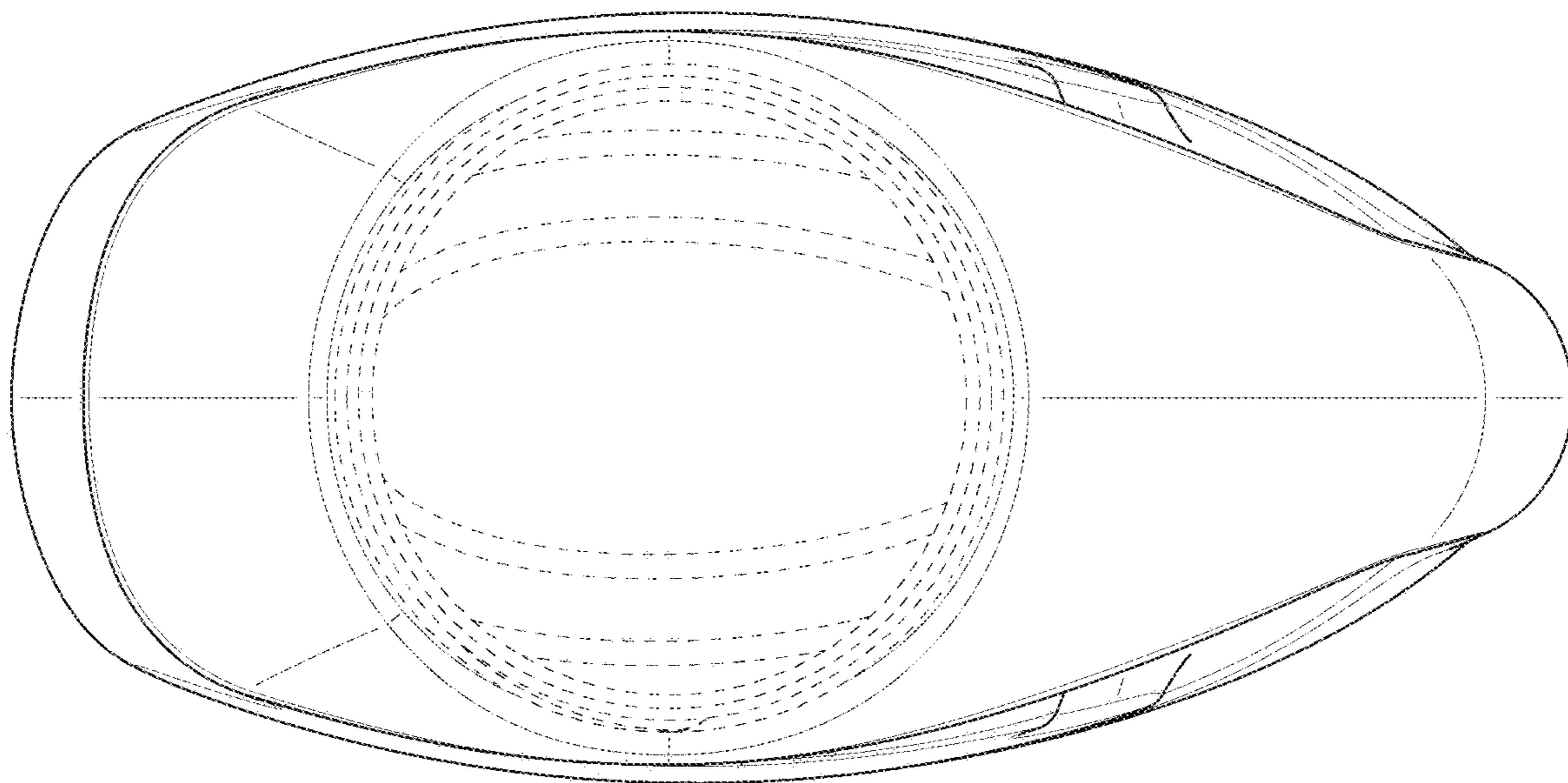

FIG. 13

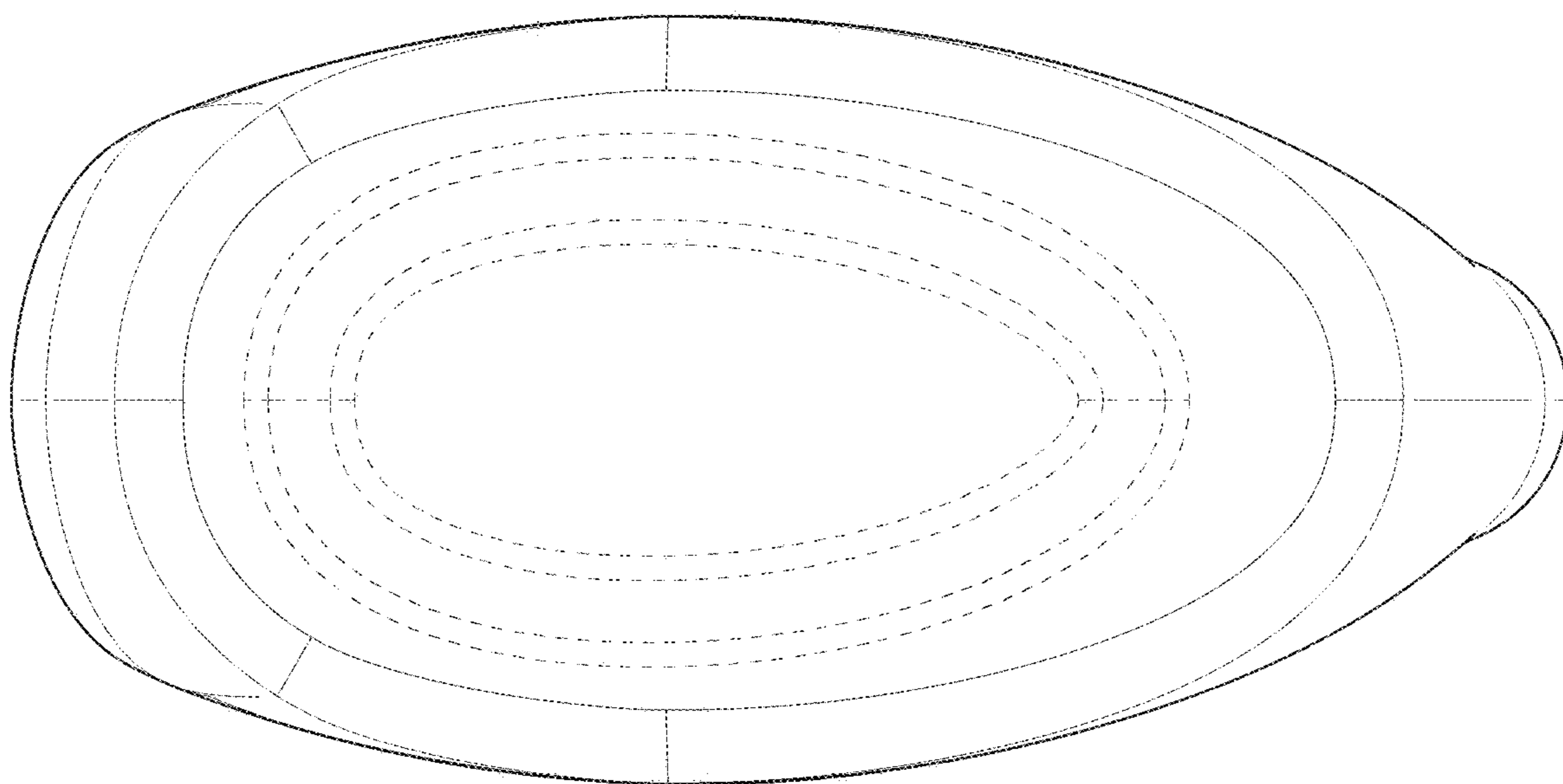

FIG. 14

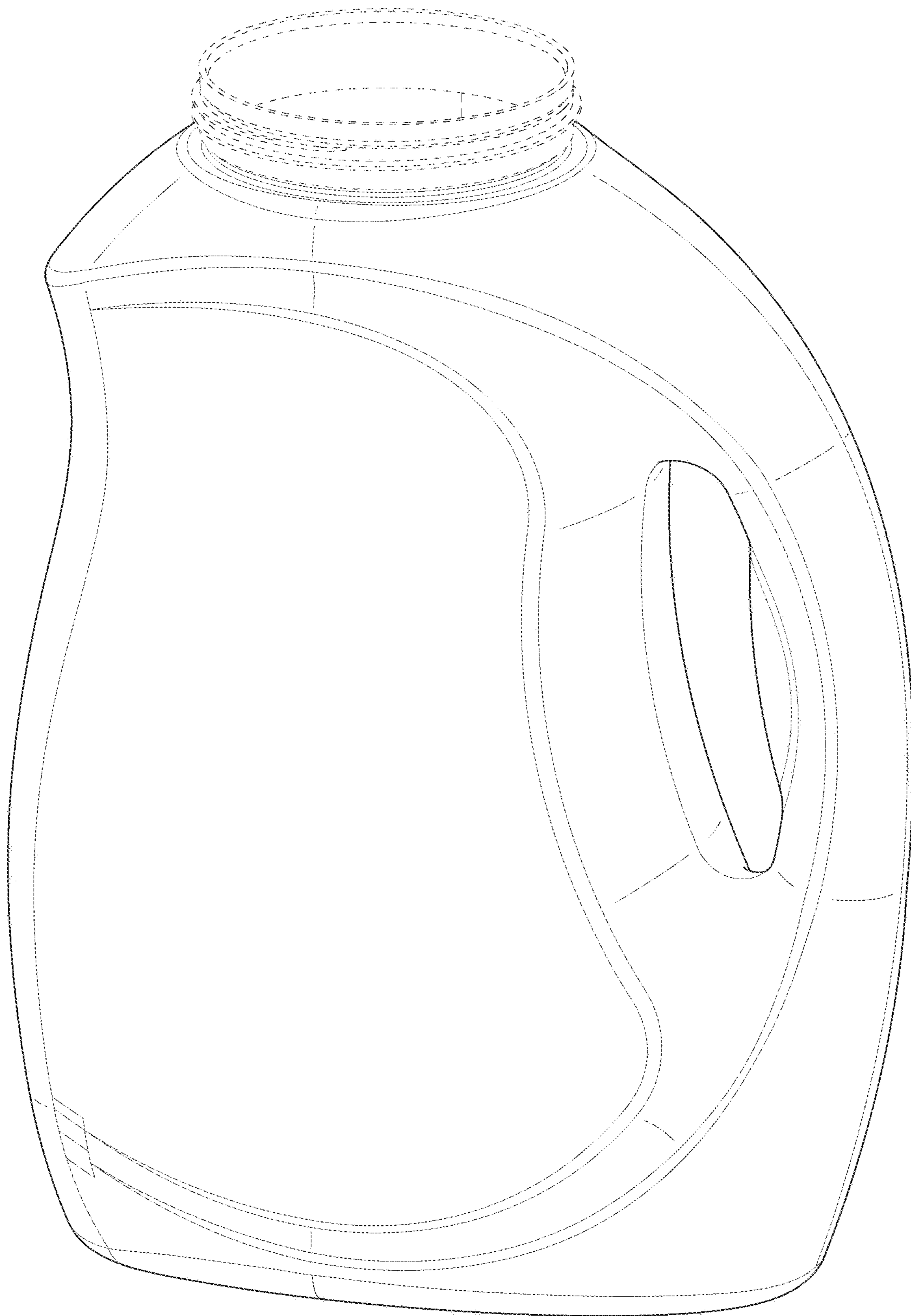

FIG. 15

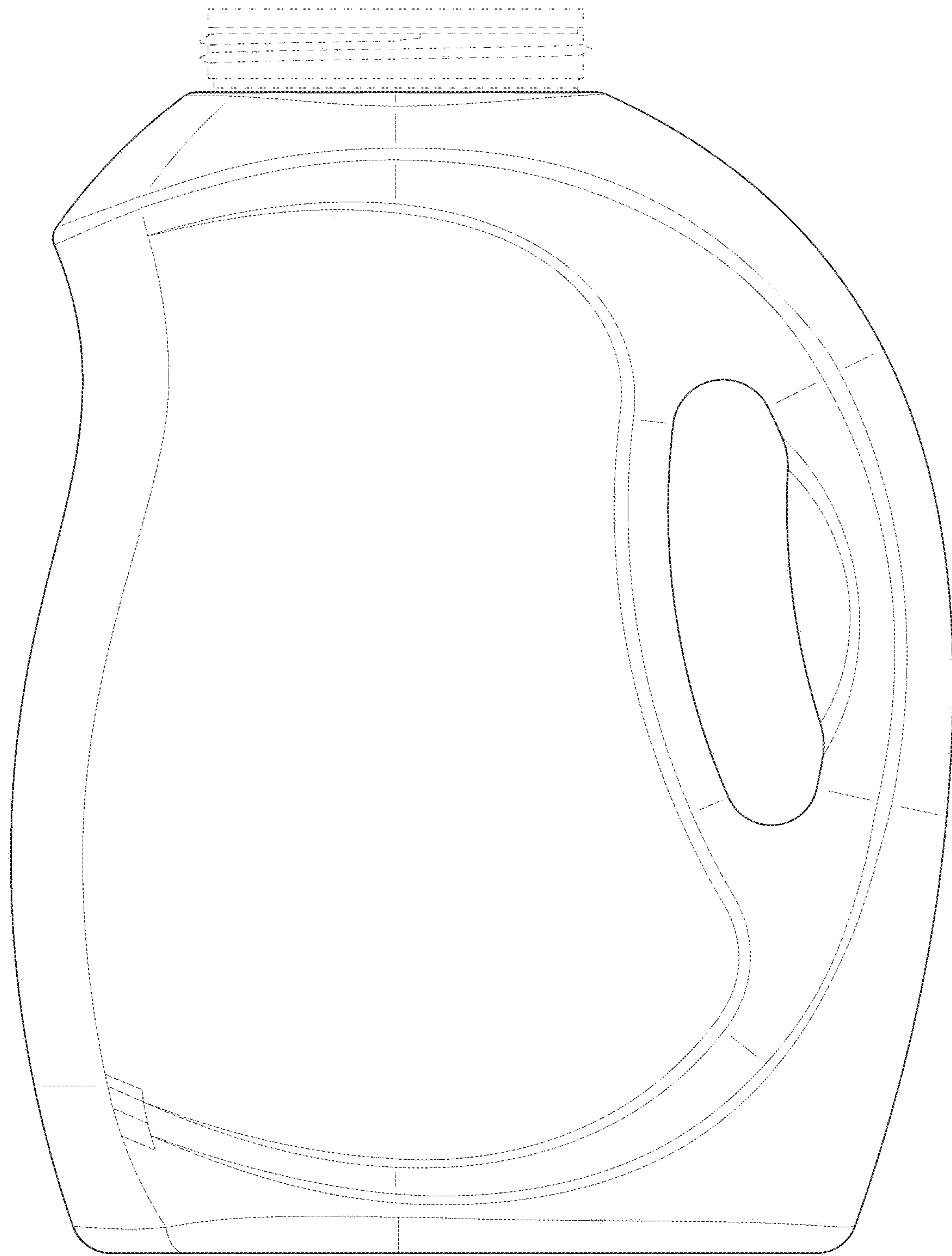

FIG. 16

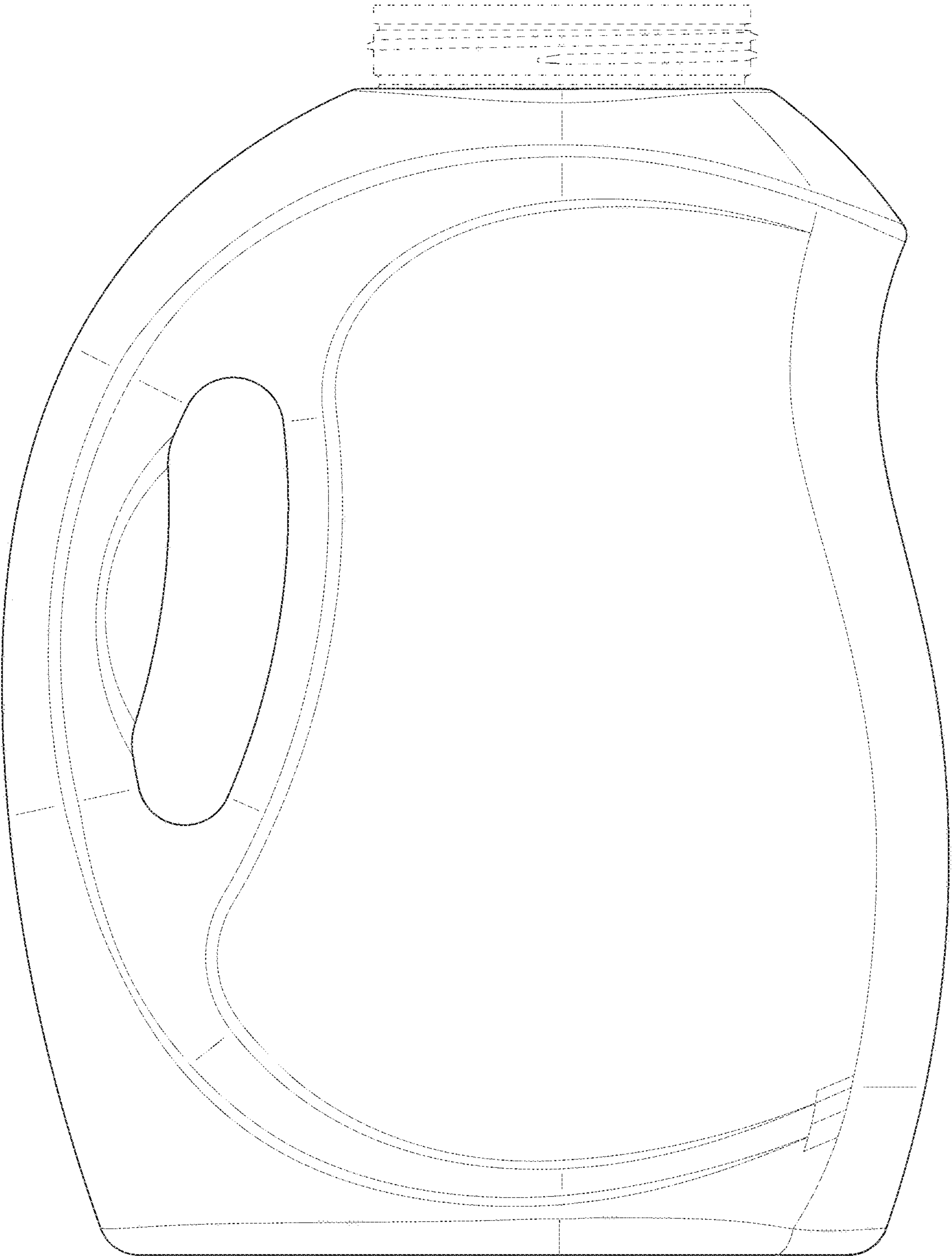

FIG. 17

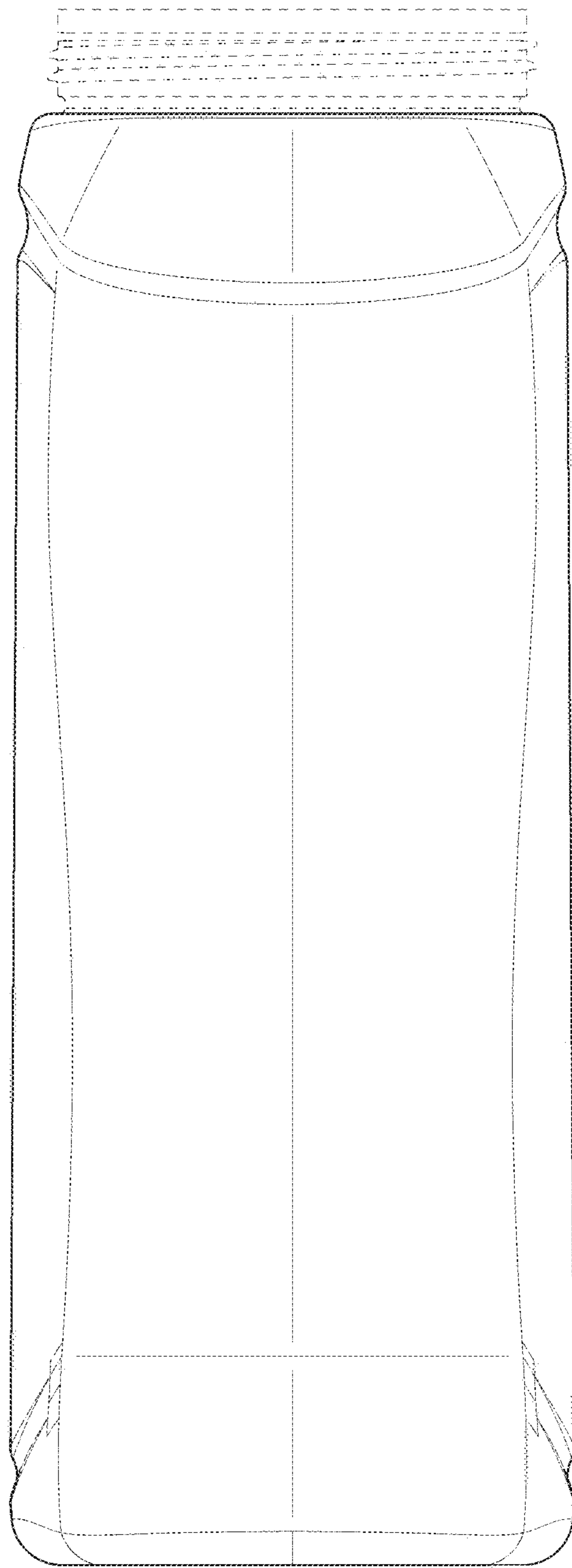

FIG. 18

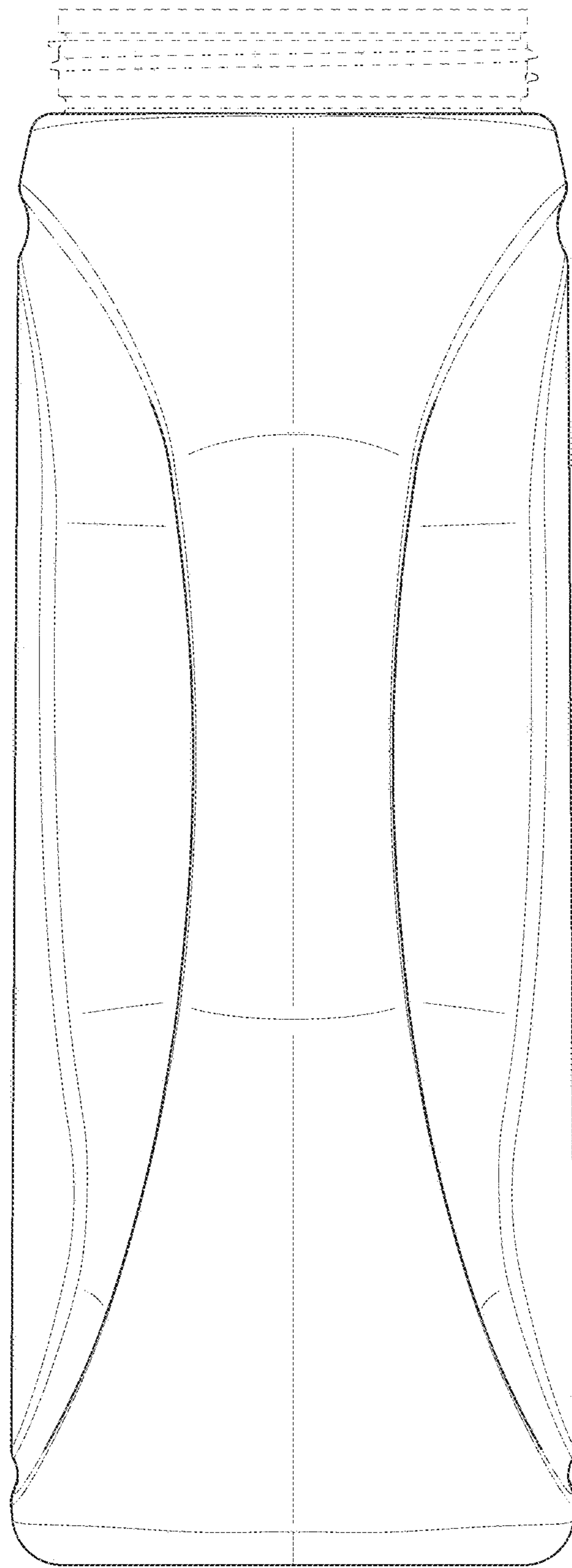

FIG. 19

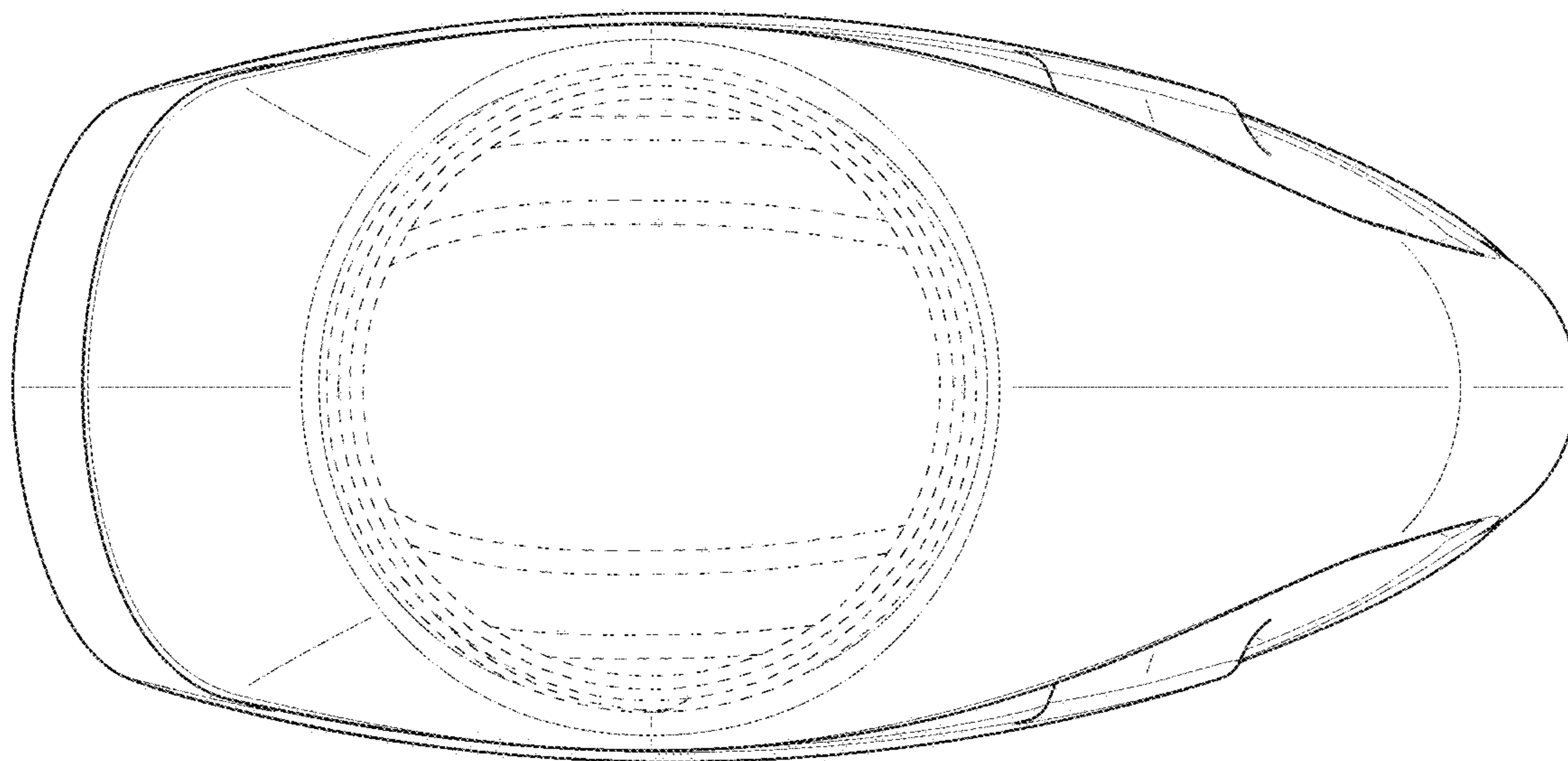

FIG. 20

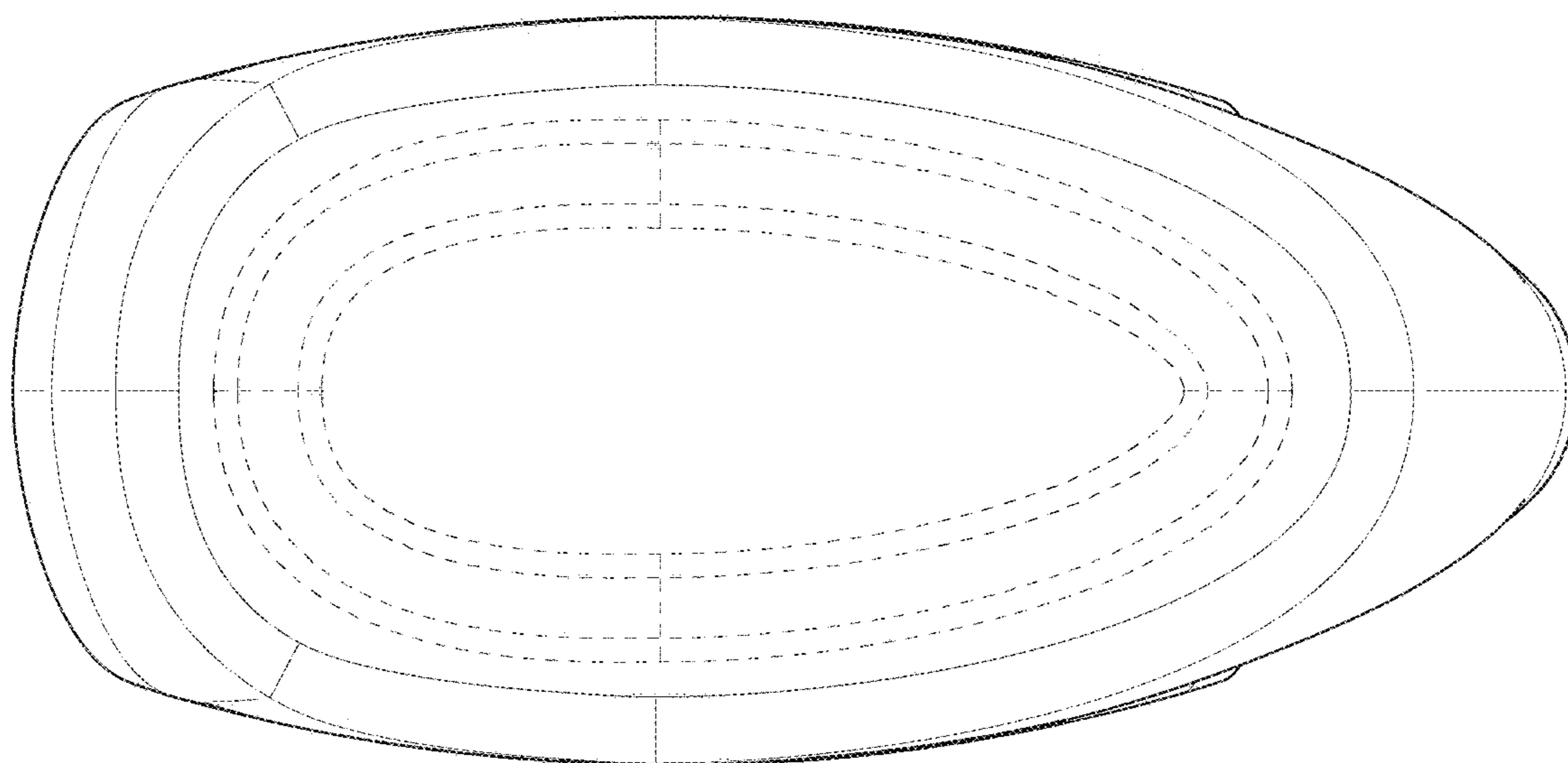

FIG. 21

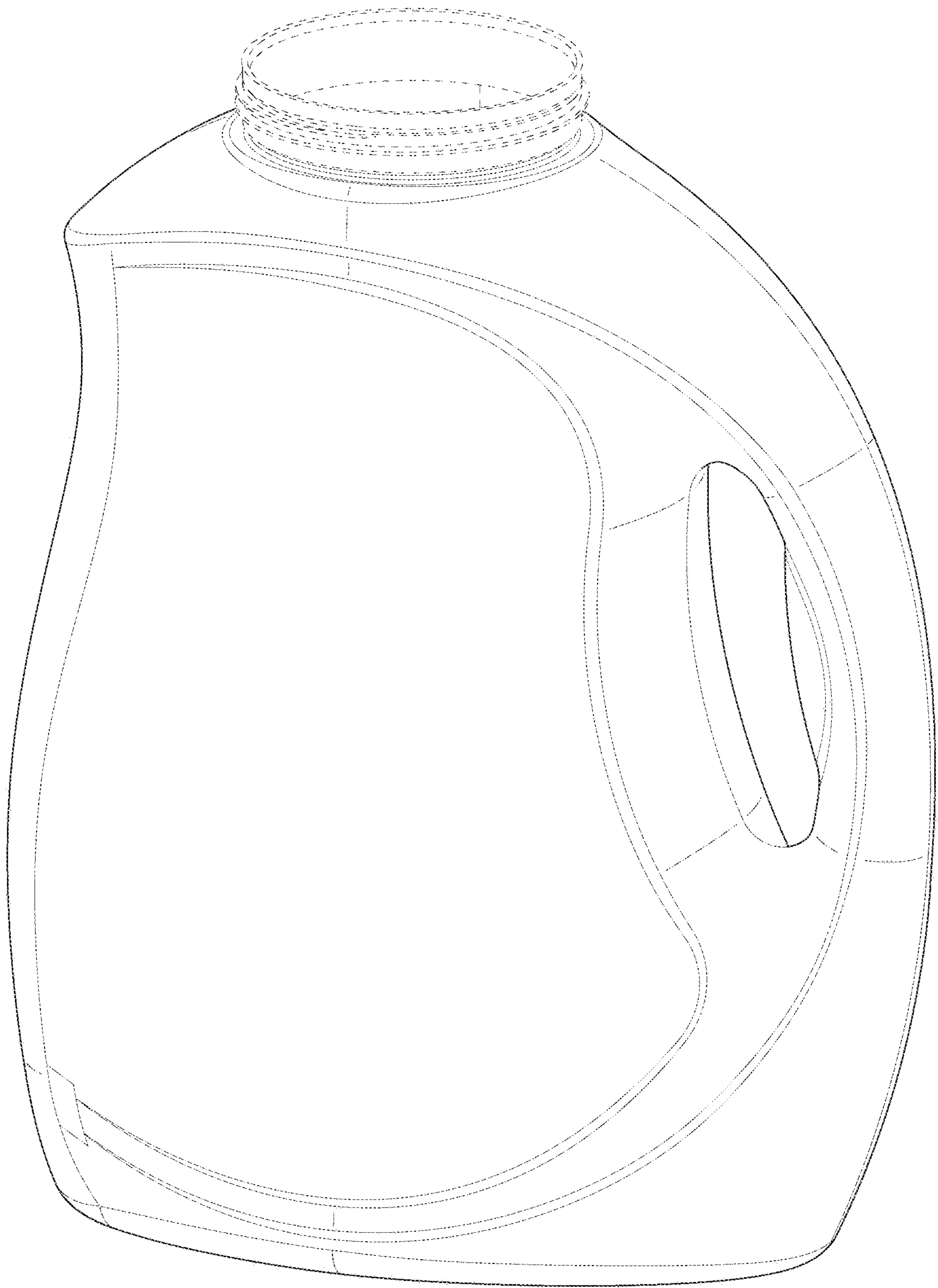

FIG. 22

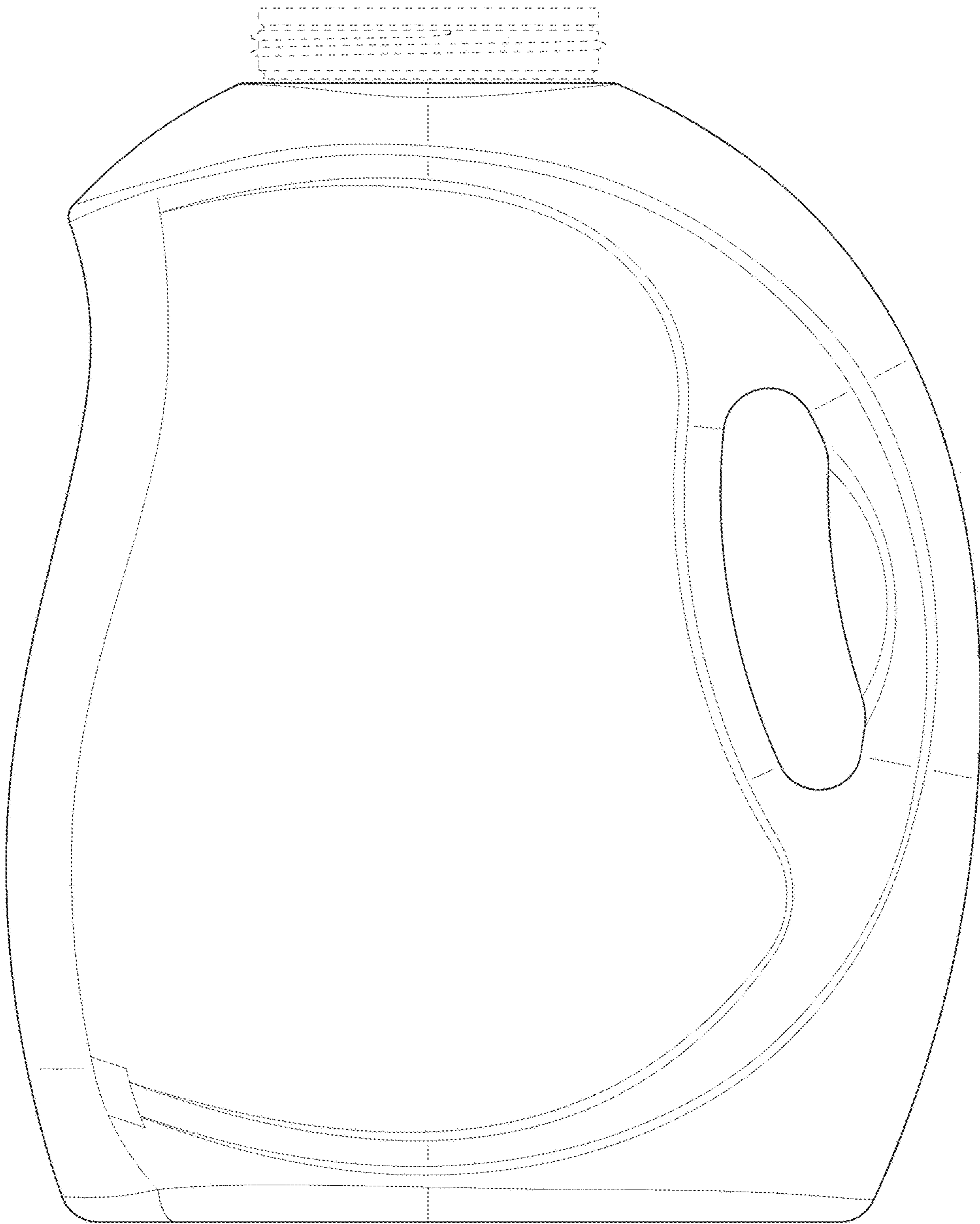

FIG. 23

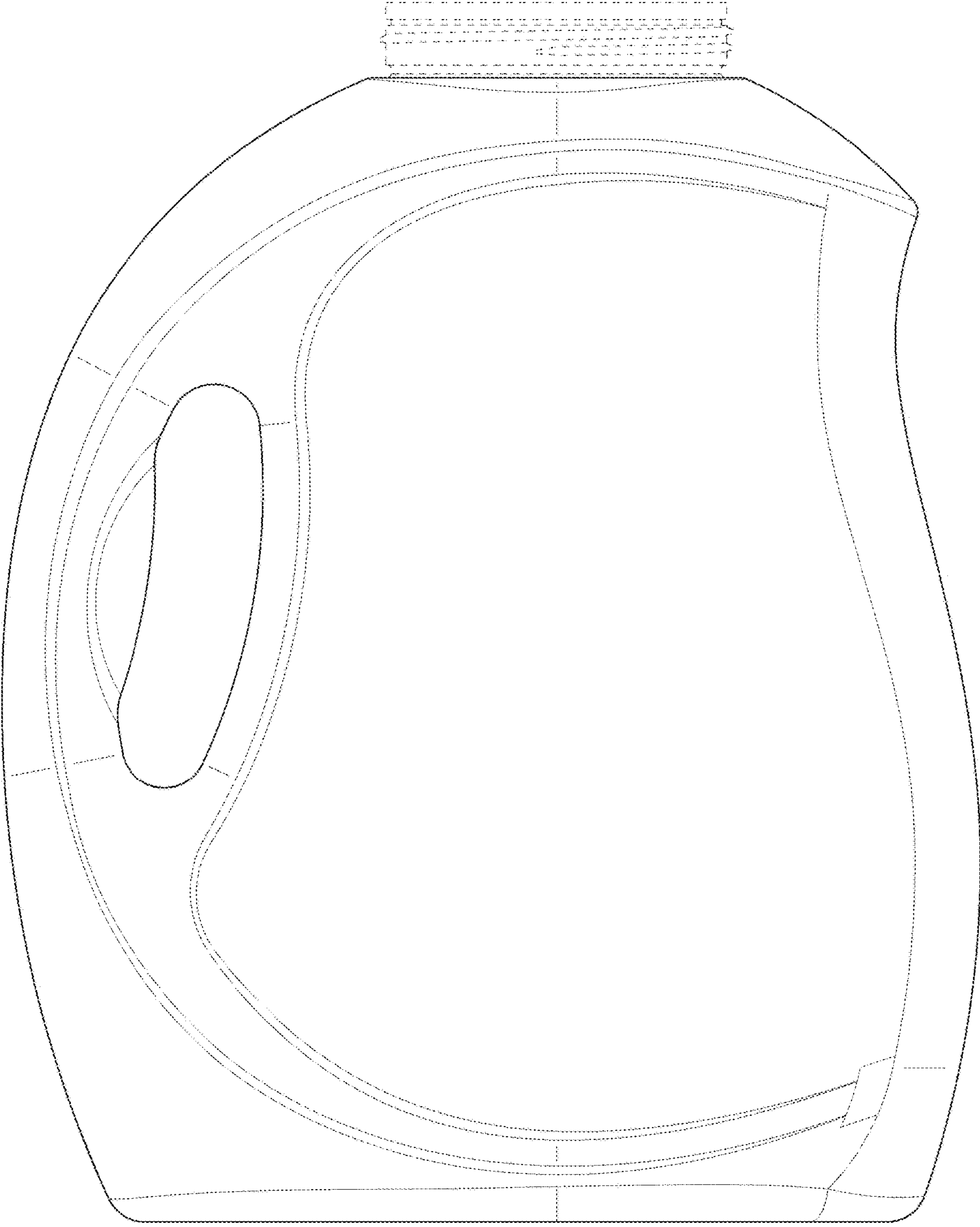

FIG. 24

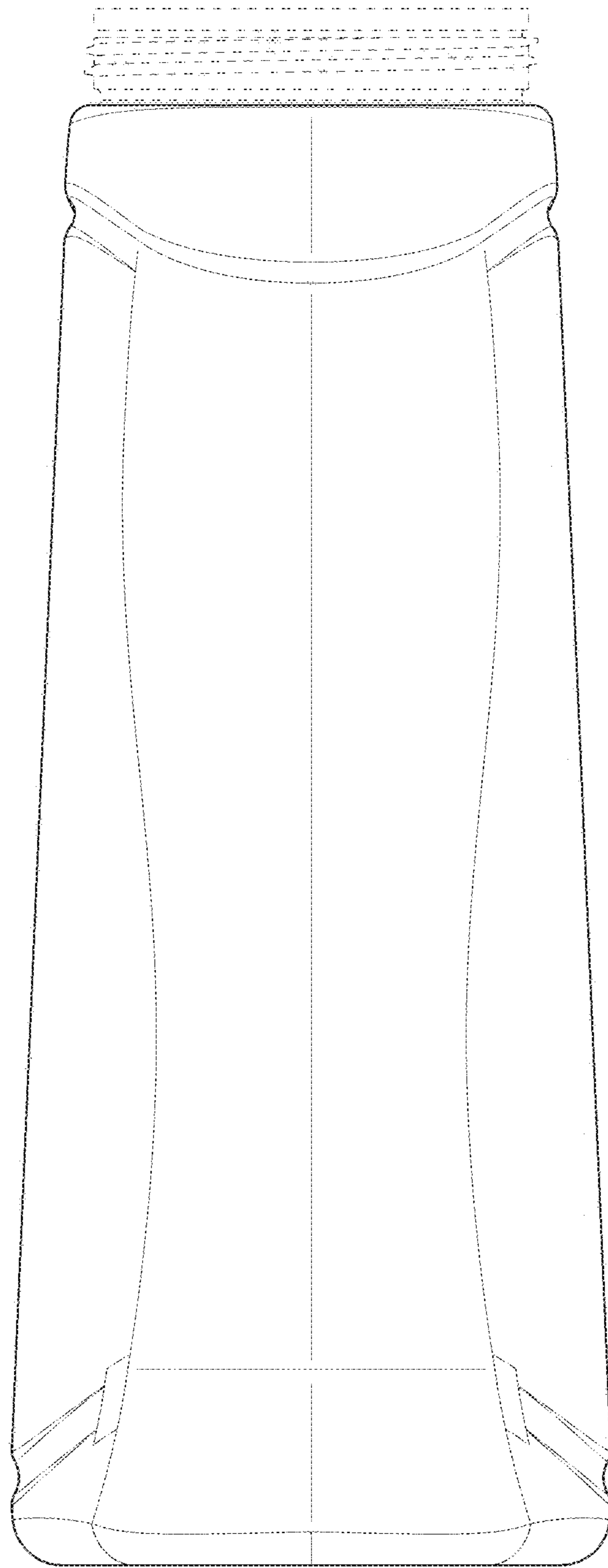

FIG. 25

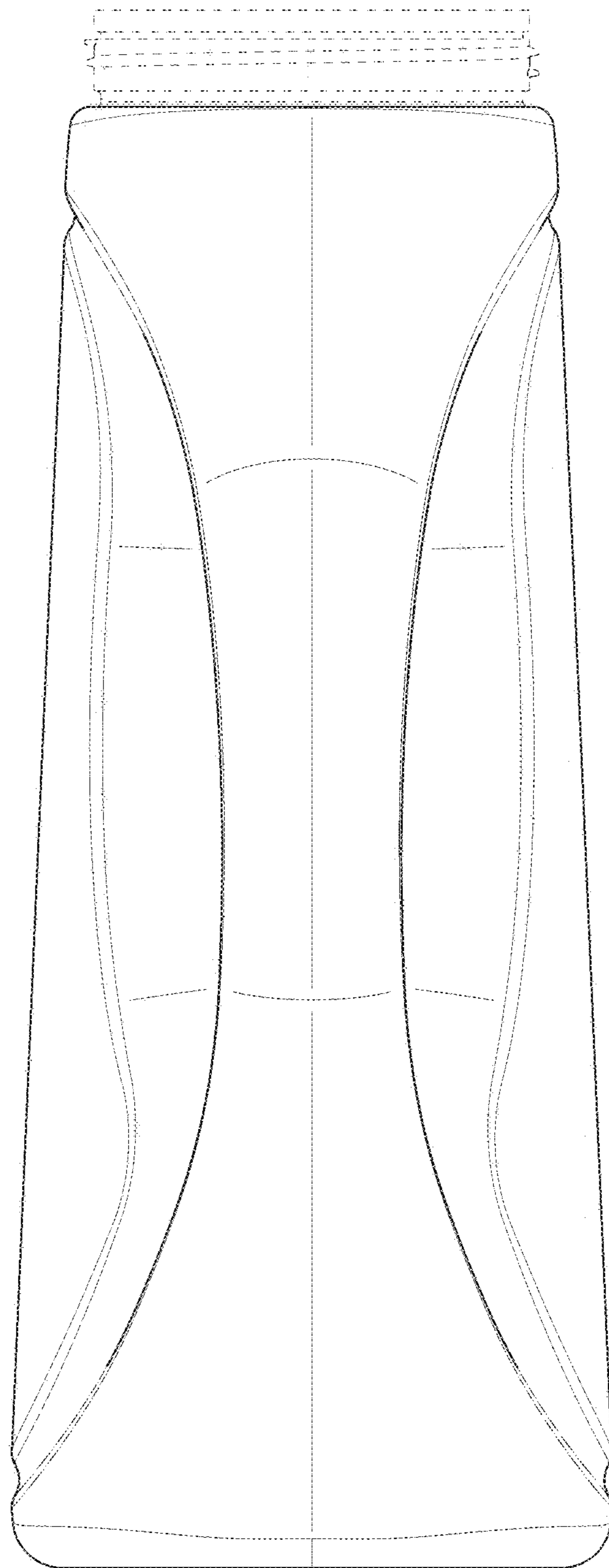

FIG. 26

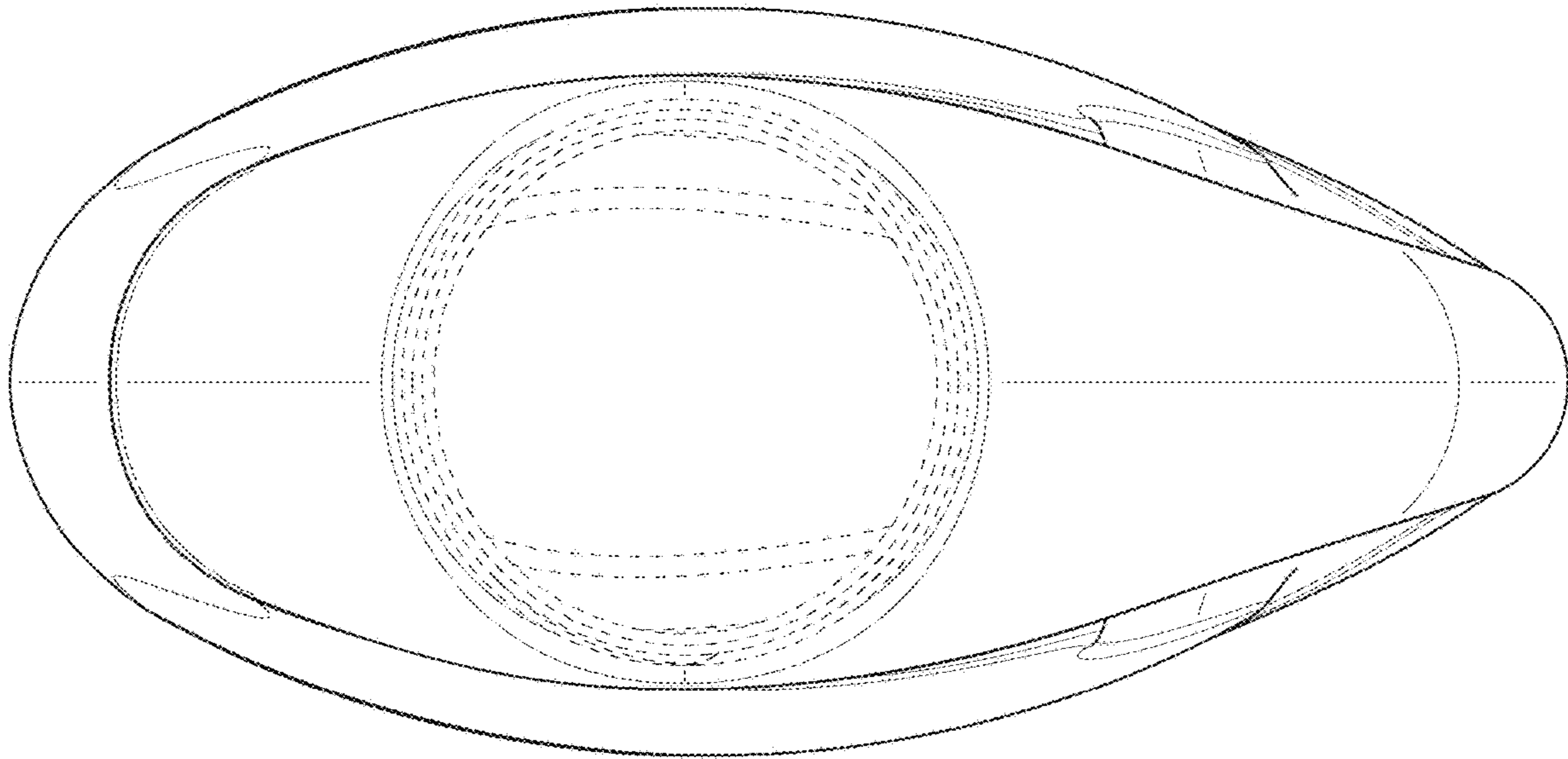

FIG. 27

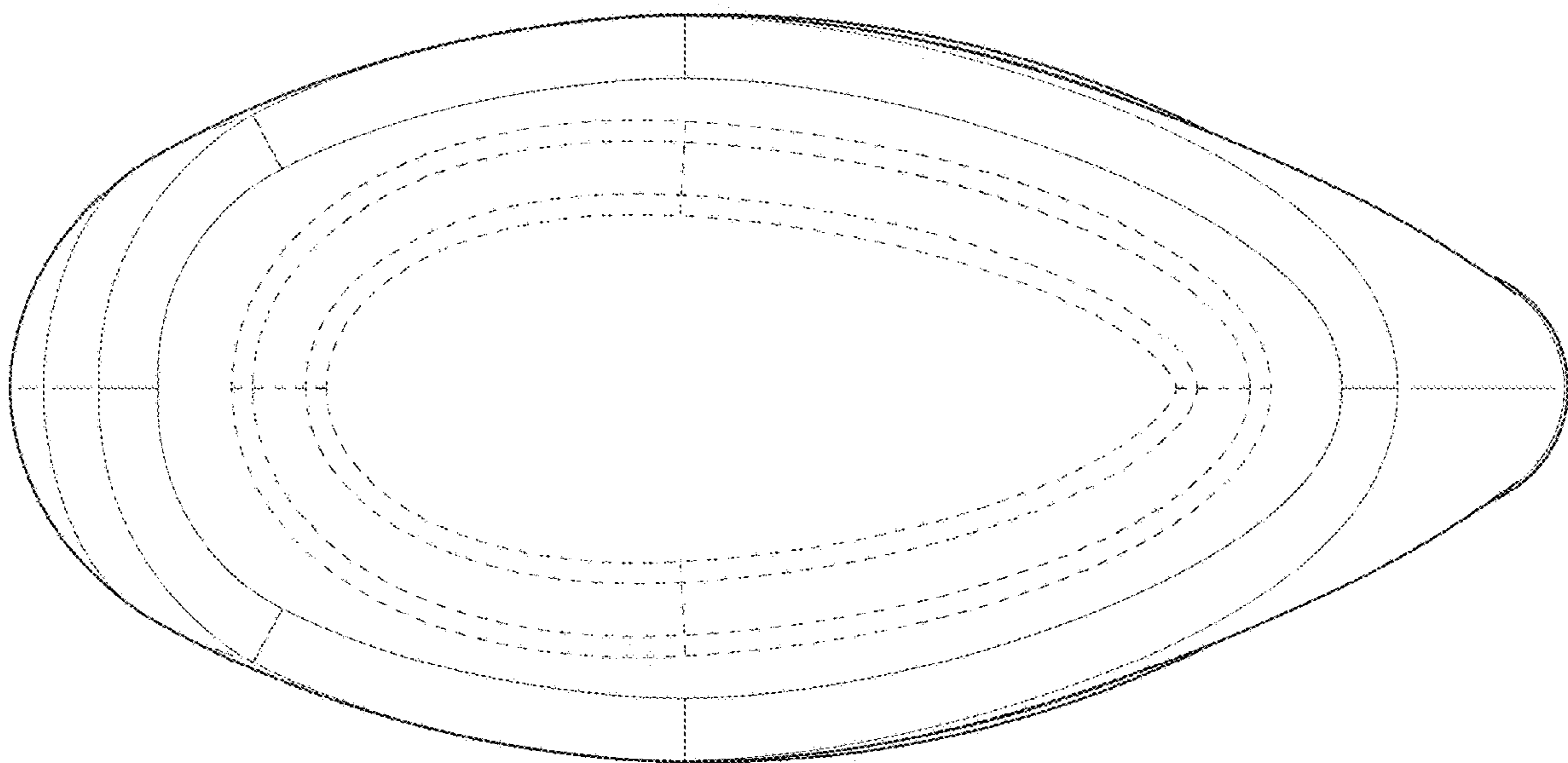

FIG. 28

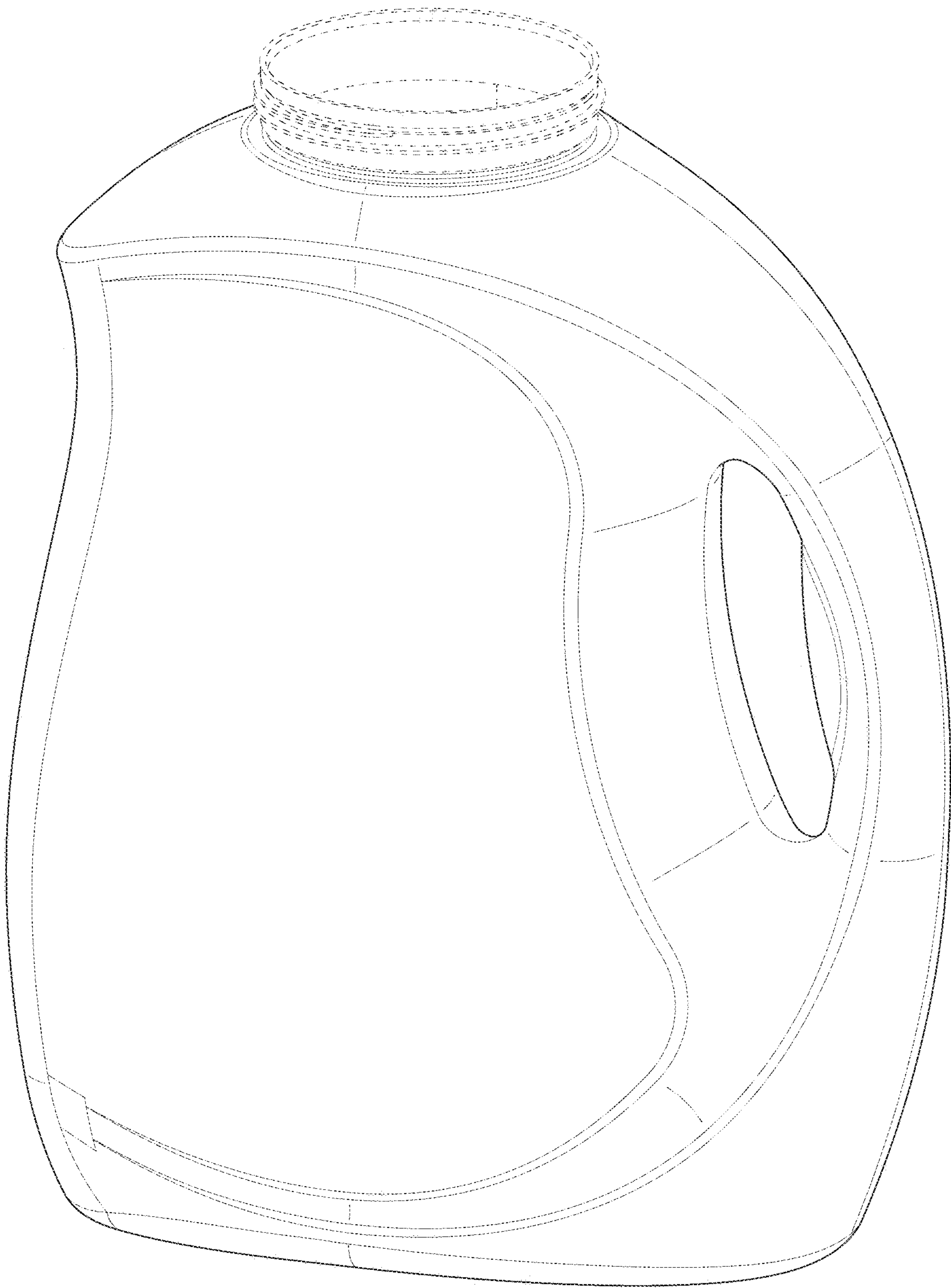

FIG. 29

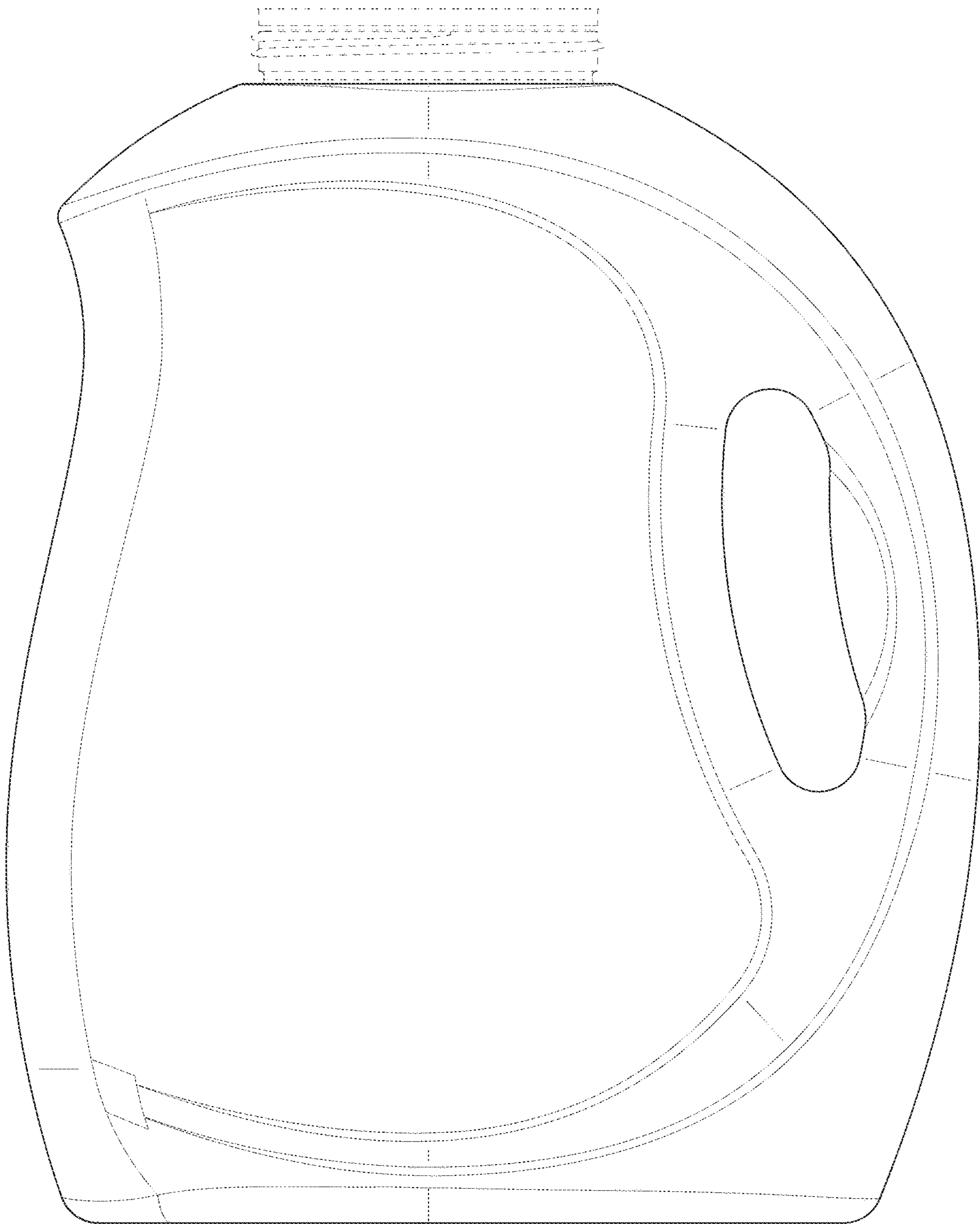

FIG. 30

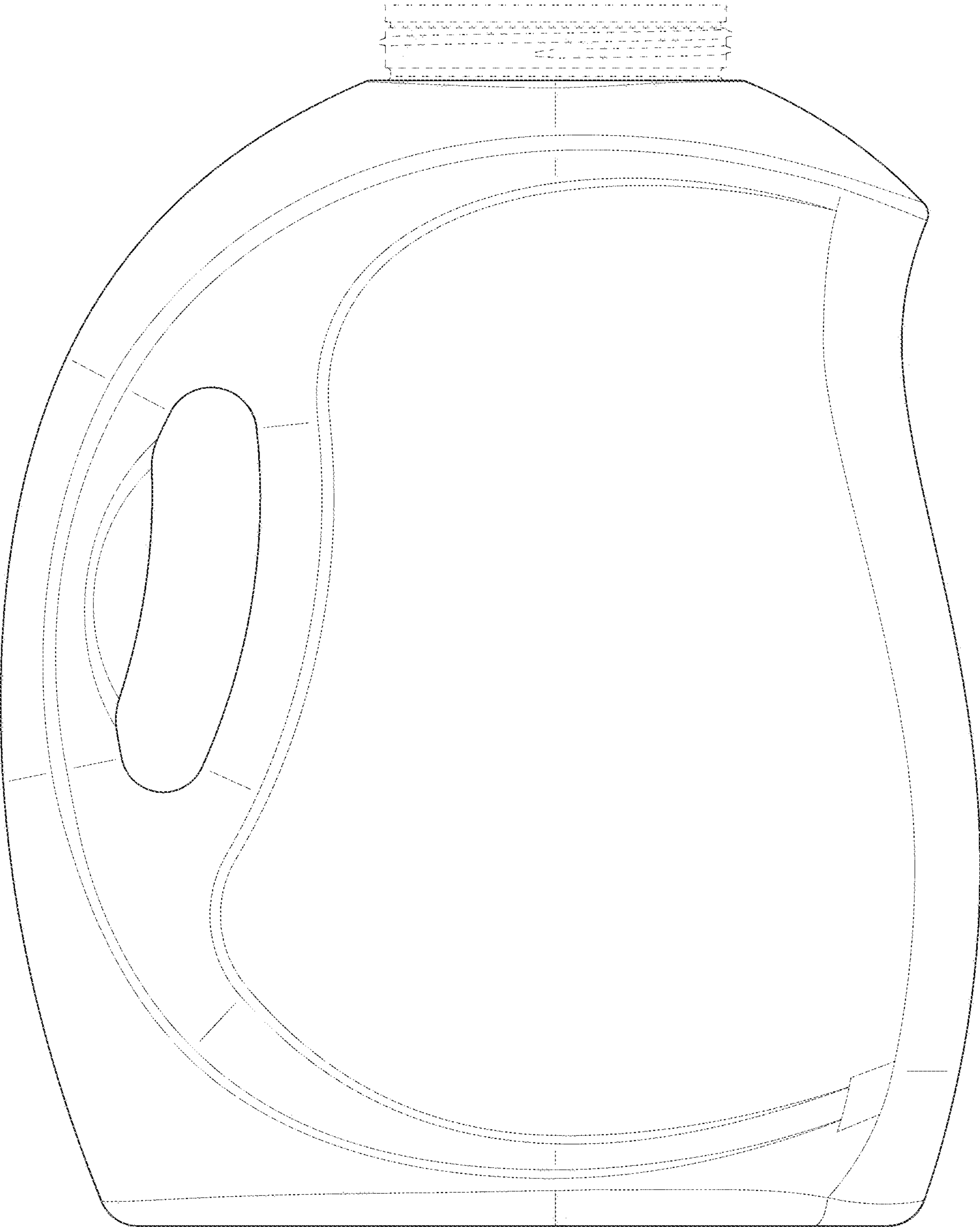

FIG. 31

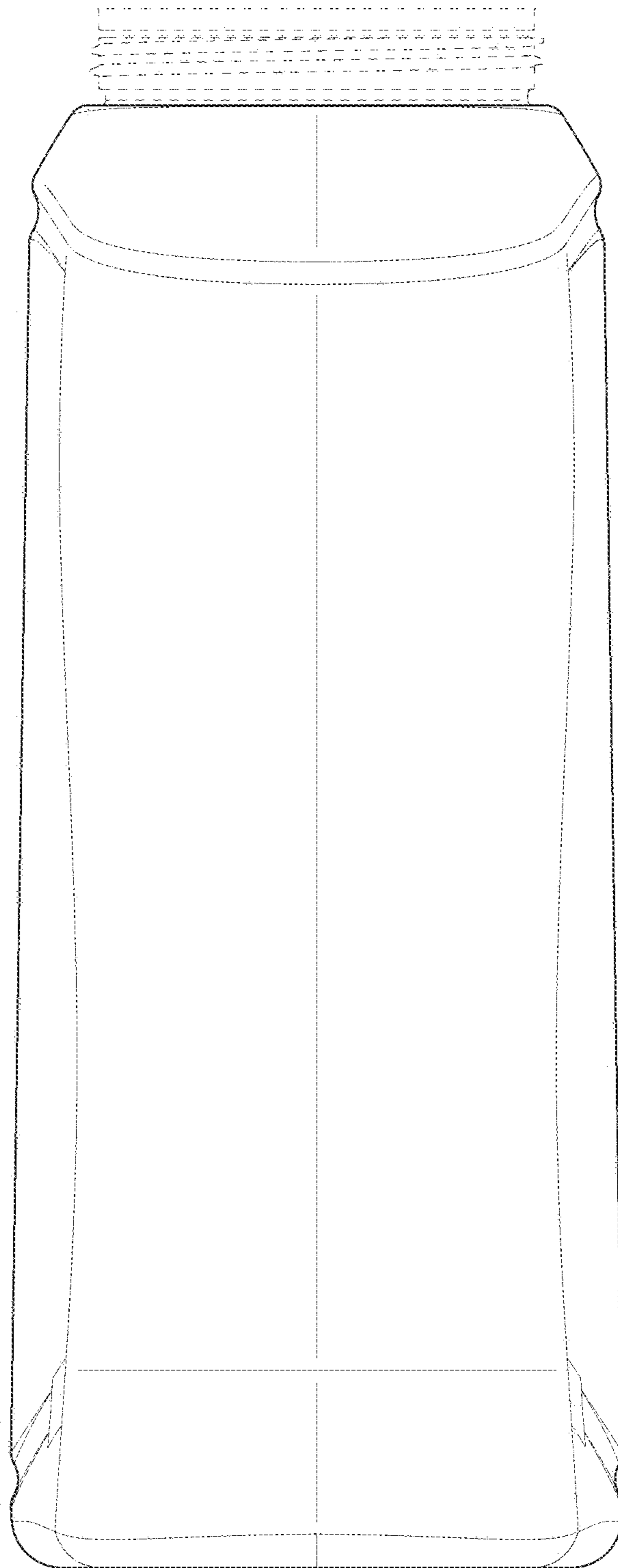

FIG. 32

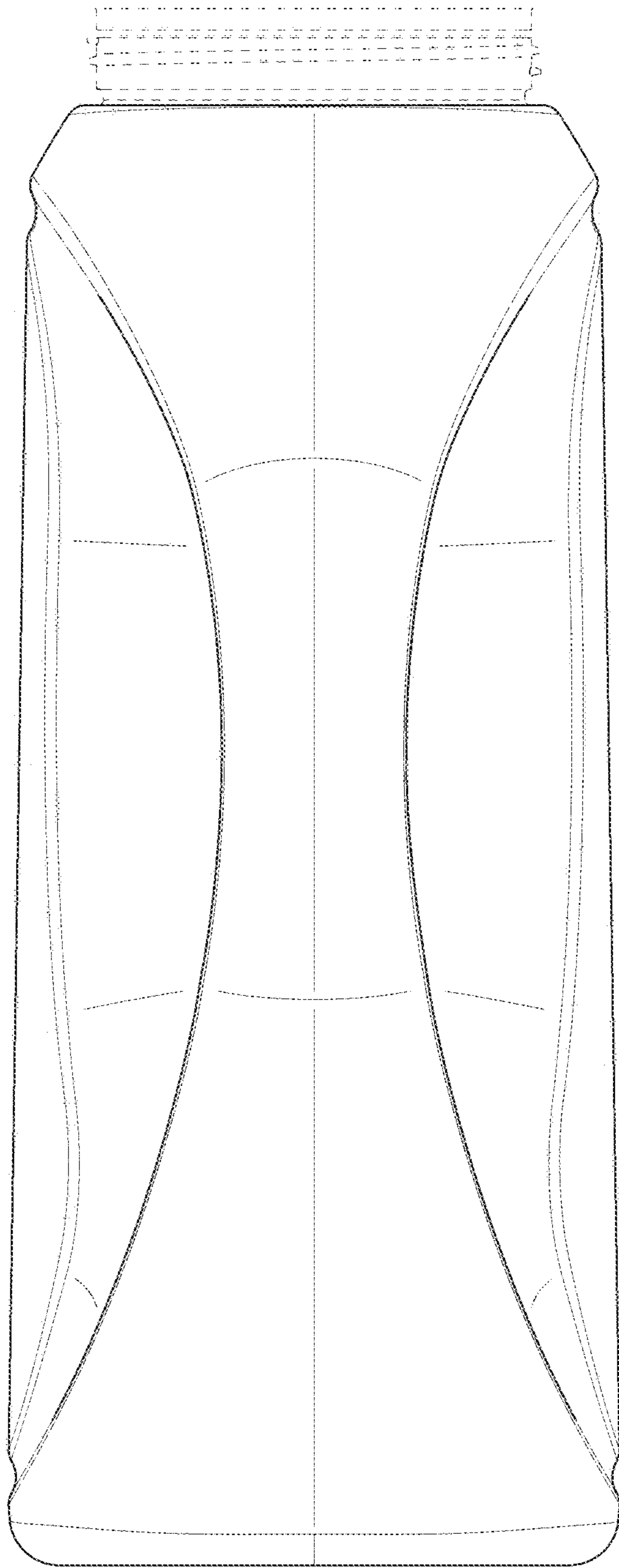

FIG. 33

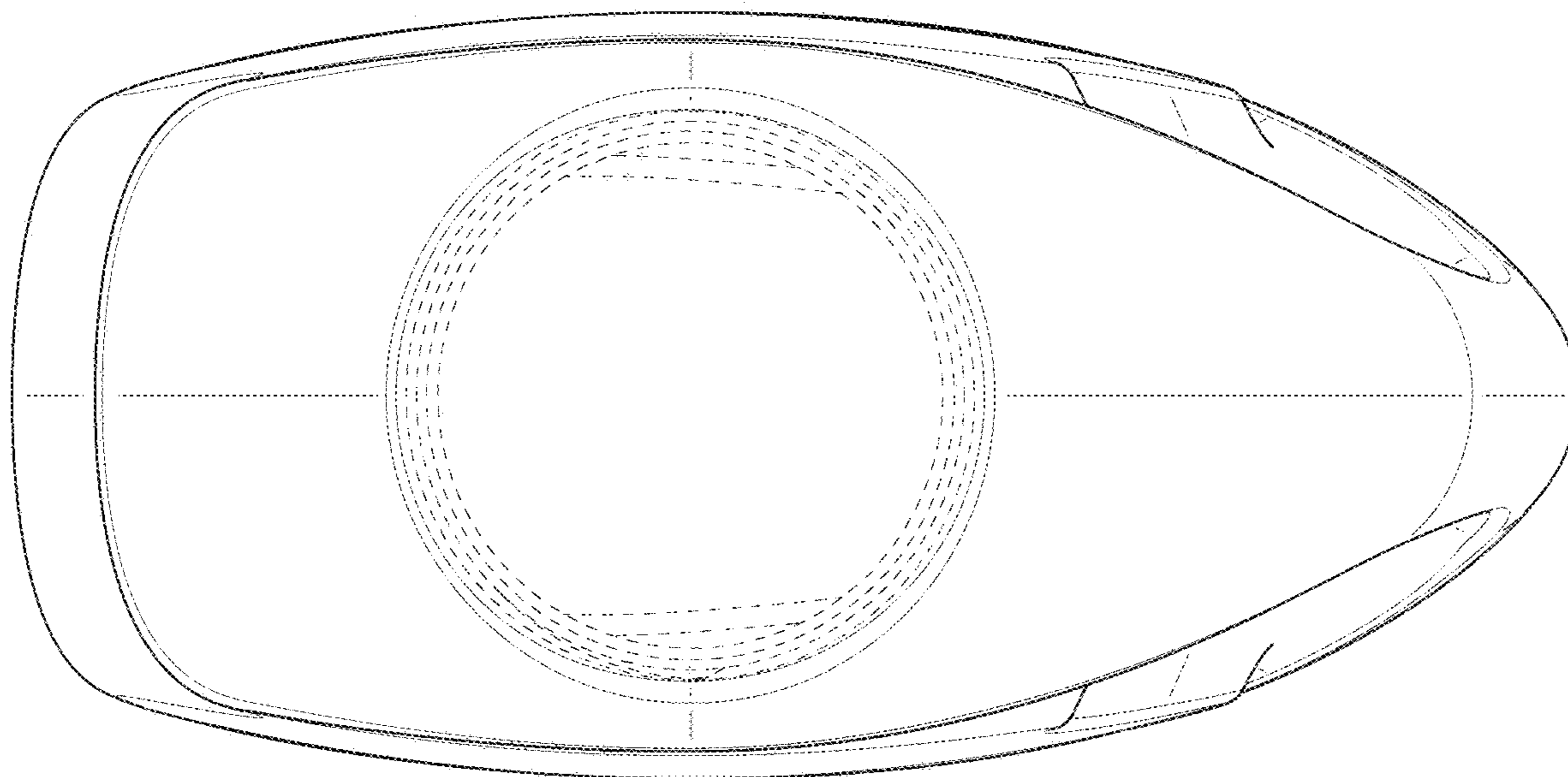

FIG. 34

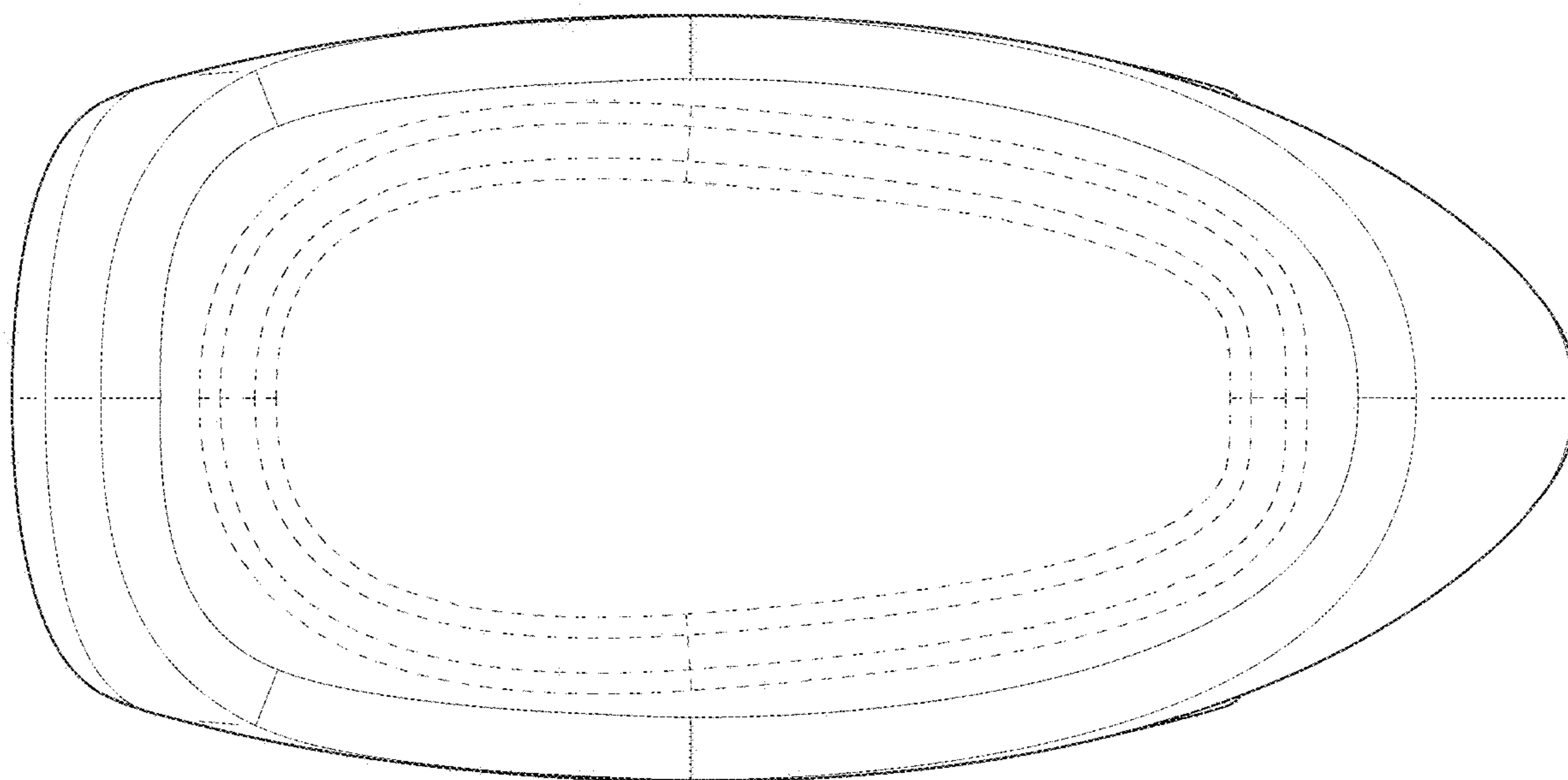

FIG. 35